

---

# **LOAD-RITE**

**ELITE SERIES**

**5 STARR SERIES**

# **Trailer Operator's Manual**

***IMPORTANT  
INFORMATION  
ENCLOSED***

Please read immediately!

LOAD RITE Trailers, Inc.  
265 Lincoln Highway  
Fairless Hills, PA 19030  
215-949-0500  
[www.loadrite.com](http://www.loadrite.com)

## Table of Contents

Introduction	2
Reporting Safety Defects	3
General Specifications	4
Attaching Trailer to Tow Vehicle	8
Trailer Adjustments	9
Determining Tongue Weight	10
AB & AC (Aluminum Bunk) Trailer Set-Up	12
Operating Information & Pre-Trip Checklist	12
Troubleshooting Chart	14
Tire Safety Information	15
Vendor Warranty Contact Information	24

### **CONGRATULATIONS!**

Thank you for your purchase. Your new trailer, manufactured by LOAD RITE TRAILERS, INC., is a truly exceptional piece of equipment and is the finest of its type, incorporating many quality features as standard equipment.

Your LOAD RITE trailer is designed and built to give many years of safe and satisfying service. In addition to our design efforts, we stand ready to assist you with any problems or questions you may have regarding the normal operation and maintenance of your new trailer. Because we are a leading manufacturer, your dealer has ready access to replacement parts, technical advice and prompt service.

In order to establish your warranty visit [www.loadrite.com/register/](http://www.loadrite.com/register/) and register online. For your own records, fill in the same information on the opposite page. If you have any questions regarding the completion of your trailer warranty information, your dealer or LOAD RITE Customer Service will be more than happy to help you. ***Your product warranty is not in effect until it is registered with LOAD RITE's Warranty Department.***

## **IMPORTANT - PLEASE READ**

Please read this manual thoroughly and completely. A basic understanding of your trailer is necessary for SAFE operation and a satisfactory experience.

Load Rite reserves the right to change specifications, designs, or discontinue models at any time without notice and/or incurring obligations.

### **Reporting Safety Defects**

If you believe that your vehicle has a defect which could cause a crash or could cause injury or death, you should immediately inform the National Highway Traffic Safety Administration (NHTSA) in addition to notifying LOAD RITE TRAILERS, INC.

If NHTSA receives similar complaints, it may open an investigation and if it finds that a safety defect exists in a group of vehicles, it may order a recall and remedy campaign. However, NHTSA cannot become involved in individual problems between you, your dealer, or LOAD RITE TRAILERS, INC.

To contact NHTSA, you may visit them at [www.nhtsa.gov](http://www.nhtsa.gov), call the Auto Safety Hotline toll-free at 1-888-327-4236 (TTY: 1-800-424-9153) or write to: NHTSA, U.S. Department of Transportation, 1200 New Jersey SE, Washington, DC 20590. You can also obtain other information about motor vehicle safety from the Hotline.

Year \_\_\_\_\_ Model \_\_\_\_\_

Serial # (VIN) \_\_\_\_\_

Dealer \_\_\_\_\_ Purchase Date \_\_\_\_\_

LOAD RITE is a registered member of the National Marine Manufacturers Association (NMMA) and the North American Trailer Manufacturers (NATM) associations. All LOAD RITE trailers are designed and built to meet all US DOT specifications and NMMA / NATM certification.

## GENERAL SPECIFICATIONS

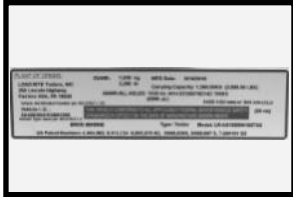

### I. TRAILER CAPACITY

Imprinted on the trailer certification plate (the VIN sticker located on the front left side of the trailer frame) is the GVWR capacity. The GVWR represents the maximum combined weight of the trailer and the load which it was designed to carry. The actual carrying capacity is the GVWR less the weight of the trailer. Carrying capacity includes the boat, motor, fuel and gear. **NOTICE: If rated**

**capacity is exceeded, the warranty is void.**



### II. TRAILER COUPLER AND BALL **CRITICAL ITEM!**

Trailer couplings are permanently marked with the following information:

- The coupler manufacturer's name or initials.
- Model or Part Number.
- Required tow ball diameter, for which rating (GVWR) shall not exceed the gross trailer weight.

**CAUTION: NEVER use a different size ball than**

**indicated on the coupler.**

CLASS I COUPLER	2,000#	GVWR	1-7/8" Ball, 3/4" Shank
CLASS II COUPLER	3,500#	GVWR	2" Ball, 3/4" Shank
CLASS III COUPLER	5,000#	GVWR	2" Ball, 1" Shank
CLASS IV COUPLER	7,500#	GVWR	2-5/16" Ball, 1" Shank
	8,000#	GVWR	2" Ball (special application, stamped)
	10,000#	GVWR	2-5/16" Ball, 1-1/4" Shank
	13,000#	GVWR	2-5/16" Ball, 1-3/8" Shank

Couplers and hydraulic brake actuators usually need no adjustments, but may require periodic grease application via the provided grease fittings, where applicable.

Be sure the ball and hitch ratings match or exceed the rated gross capacity (GVWR, trailer weight and capacity) of the loaded trailer.



### III. SAFETY CHAINS AND CABLES

Each trailer is equipped with two towing safety chains or cables located adjacent to the coupler / actuator. When attaching the trailer to the tow vehicle, connect each of the safety chains or cables to a separate point on the tow vehicle hitch per the hitch manufacturer's instructions. The safety chains or cables should criss-cross beneath the coupler / actuator and before attaching to the tow vehicle

The bow safety chain or cable (if equipped) located adjacent to the winch is an added safety feature and must be used by the operator when towing. After sliding the "S" hook through the bow eye of the boat, adjust the chain as tight as possible by securing it at the key hole slot on the winch support bracket. If trailer is equipped with a cable, it is non-adjustable and should be attached to the bow eye of the boat.

### IV. TONGUE JACK

Some LOAD RITE trailers may be equipped with a tongue jack for the purpose of raising the coupler to a level above the tow ball to facilitate connecting the coupler to the tow vehicle.

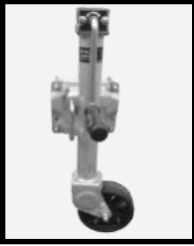

Tongue jacks may be vertically fixed or have allowance to swivel when not in use. Tongue jacks may be fitted with either a flat foot or a dolly wheel at the point of ground contact.

The dolly-wheeled tongue jack is designed to allow some mobility of the empty trailer on a smooth surface. It is not recommended that a loaded trailer be moved with the dolly wheel under load.

***CAUTION: DO NOT attempt to move a trailer with a dolly-wheel equipped tongue jack under load.***



#### V. WIRE COLOR CODE AND LIGHTS

Harness wire colors correspond to the following functions:

- **White** – ground
- **Brown** (2) – left and right taillights, sidemarker lights, and clearance lights
- **Yellow** – left turn and stop light
- **Green** – right turn and stop light
- **Blue** – disc brake free-backing solenoid, to be energized by tow vehicle back up lights

The above wires each correspond with individual circuits on the tow vehicle. *Refer to the trailer dealer, hitch installer, or local automotive repair shop to have the proper tow vehicle connector installed.*

To avoid overloading tow vehicle electrical circuits with the trailer lighting system, make certain the tow vehicle is equipped with a properly installed trailer harness connection.

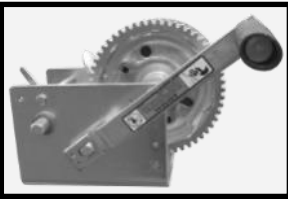

#### VI. WINCH

LOAD RITE boat trailers are equipped with a hand-operated winch designed for long life and to facilitate trouble-free launching and loading.

Periodically, the gears of the winch should be inspected for wear and lubricated with an all-purpose grease. Inspect the winch cable, rope, or strap for damage or frayed fibers at each use. When retrieving, be sure to spool the cable or rope evenly across the winch drum.

***NOTICE: Replace any component immediately if any sign of wear is evident.***

***NOTICE: To extend cable or rope life, avoid a criss-cross overlap pattern while retrieving.***



#### VII. SECURING THE CARGO FOR TRAILERING

Tie down the boat securely at the bow and stern with approved tie downs. Ratcheting straps of appropriate capacity are recommended.

***CAUTION: Do not rely on the winch cable, rope, or strap alone to secure the boat to the trailer.***

In addition to the winch cable or strap use the bow safety chain or cable, if equipped. Be certain that the bow is resting snugly against the bow roller(s) or bunk(s). In addition, the boat transom should be secured to the rear of the trailer. If possible, additional straps over the boat hull offer added security. Any loose cargo must be secured within the boat.



#### VIII. BOLTS, NUTS, AND FASTENERS

Upon initial trailer inspection, and on a continuing regular basis, inspect for loose, damaged, or excessively corroded hardware.

**CAUTION:** *Lug nuts should be checked before each use.*

<b>Wheel Diameter</b>	<b>Stud Size</b>	<b>Stud Pattern</b>	<b>Torque Value Min / Max</b>
12" & 13"	1/2"-20	5 on 4.5"	60 - 75 lb./ft.
14" & 15"	1/2"-20	5 on 4.5"	90 - 120 lb./ft.
15" & 16"	1/2"-20	6 on 5.5"	90 - 120 lb./ft.
16"	9/16"-18	8 on 6.5"	140 - 170 lb./ft.



### **IX. BEARINGS AND HUBS**

**NOTICE:** *This section does not apply to trailers equipped with optional "touchless" style hubs.*

Most LOAD RITE trailers are equipped with a lubrication system which incorporates an internally cored spindle and grease fitting. This allows hubs to be easily greased with minimal disassembly and assures lubrication to the inner bearing. Using a high temperature NLGI #2 wheel bearing grease and a hand-operated grease gun, apply grease after each

immersion of a warm hub into ambient water. This will displace any water introduced during the rapid cooling process during immersion.

It is recommended that grease be added frequently to displace contaminants that may have infiltrated the bearing cavity.

**NOTICE:** *Check wheel bearings periodically by the following procedure:*

**CAUTION:** *With the trailer connected to the tow vehicle on level ground, set the tow vehicle parking brake and chock the wheels.*

- Chock the trailer wheel opposite the hub to be checked, placing chocks both in front and behind the tire.
- Position the service jack on the frame as near the wheel to be removed as possible.
- Rotate the elevated wheel and listen for any noise. If the trailer is equipped with drum brakes, be certain that the brake shoes are not dragging. Disc brakes are in constant light contact with the brake rotor. Rotate the wheel in search of any roughness in its rotation.
- A quiet and smooth rotation indicates that the bearings are in good shape. If a noise, grinding sound or roughness in rotation are evident, please contact the trailer dealer for service.
- At this time the wheel bearing adjustment should be checked. To check if bearing adjustment is needed, grip the circumference of the wheel assembly at top and bottom to see if it rocks or can move laterally on the spindle centerline. If the wheel moves at all, an adjustment is necessary. Refer to dealer for service.
- Add grease through the hub zerker fitting as directed by the hub manufacturer.

**NOTICE:** *Bearing adjustment should be checked after the first 75 miles of service and every year after.*

**NOTICE:** *It is required that once a year each hub be removed and the following items visually inspected and replaced if necessary: bearings, bearing races, seals and brake components. Repack with new grease and reassemble using a new cotter pin. All work should be performed by a qualified mechanic. This section does not apply to trailers equipped with optional "touchless" style hubs.*

Refer to [www.loadrite.com/resources/documents/](http://www.loadrite.com/resources/documents/) for applicable information referring to specific instructions for different hub designs.



#### X. "Touchless" STYLE MAINTENANCE FREE HUBS

"Touchless" style hubs are intended to be maintenance-free. The warranty period and offer details may vary by hub manufacturer.

In general, the manufacturer of this style of hub requires no maintenance for a pre-determined number of miles. Attempting to disassemble or perform any maintenance may void the hub manufacturer's warranty.

Should it be necessary to perform any maintenance on a "touchless" hub, it is imperative that the lubricant be replaced with the hub manufacturer's specified formula without substitution.

**NOTICE:** Refer to the hub manufacturer's documentation or website for further details.



#### XI. TIRES

**NOTICE:** Refer to Tire Safety information on pages 12 -23.

To identify the proper tire and rim size and capacity specified for the trailer model refer to the Vehicle Identification Number certification plate or Tire Placard sticker located on the front left side of the trailer frame beside the VIN. Recommended tire air pressure can be found on the certification plate and on the tire sidewall.

**NOTICE:** Always check tire pressures when cold. Always fill to the maximum rated cold pressure. NEVER over inflate tires. NEVER operate a trailer with underinflated tires.

Should the certification plate be damaged or otherwise illegible, the dealer or manufacturer can determine the proper tire, rim size, and pressure through VIN identification.

When changing a tire follow the same procedure as outlined in section IX for checking hub bearings. Be sure to properly torque wheel attachment fasteners per chart in section IIX.

**CAUTION:** When replacing tires, use only tires with the ST (Special Trailer) designation. Do not mix radial and bias-ply tires on the same axle.



#### XII. BRAKES AND ACTUATOR

LOAD RITE defers to local department of motor vehicle authority to determine brake requirements for the jurisdiction in which the trailer is to be registered. For safety, LOAD RITE recommends brakes on ALL axles where available.

The hydraulic brake system requires DOT 3 brake fluid. Check the actuator reservoir regularly and top off with fresh

DOT 3 brake fluid from an unopened container.

Braking components should be thoroughly rinsed **and dried** before storage for optimal service life.

**CAUTION:** Wet brakes operate less efficiently. Use care in operating the trailer immediately after launching or loading.

#### XIII. FINISH

Galvanized trailers may occasionally show a rust spot or surface discoloration. If this occurs, lightly address with a nylon scrub pad and touch up with cold-galvanizing spray paint. This product can be obtained through any LOAD RITE dealer, or most paint, hardware, or marine stores.

**NOTICE:** After exposure to salt water, wash the trailer thoroughly with fresh water at the first convenient opportunity. After thorough washing, dry surface with a towel, air dry with a power tool or a short ride.

**NOTICE:** Always thoroughly dry all components, especially brakes, before storage.

# ATTACHING THE TRAILER TO THE TOW VEHICLE

## I. PROPER TOW BALL HEIGHT

Tow ball centerline height should be set between 18" to 21" from the ground for level towing. Various ball mounts can be purchased to facilitate tow ball height adjustment. Make certain the tow vehicle is properly equipped and set up. Once attached to the tow vehicle, trailer frame should be parallel to level ground.

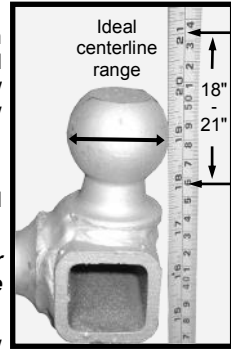

## II. ATTACH COUPLER / ACTUATOR TO TOW BALL

Confirm tow vehicle is equipped with a properly sized, rated, and positioned ball.

**NOTICE:** *LOAD RITE trailers are equipped to accept either a 2" or 2-5/16" diameter tow ball depending upon rated capacity. The coupler / actuator is clearly marked for this requirement.*

Raise the trailer on the tongue jack so that the ball of the tow vehicle can be maneuvered directly beneath the ball socket of the coupler / actuator.

Remove any safety lock pins from the actuator lever and move the lever to the correct position for ball attachment per manufacturer's instructions.

Crank the handle of the tongue jack to lower the coupler / actuator onto the tow vehicle ball. Once the coupler / actuator is fully seated on the ball, complete latch procedure per manufacturer's instructions. With the coupler on the ball and latch fully engaged, insert the safety pin through the coupler / actuator slider in the hole located directly behind the ball socket if so equipped, or that hole designated in the manufacturer's instructions.

Continue to crank the tongue jack to its fully retracted position. If possible, rotate the jack to its horizontal position and store for transport.

## III. ATTACH SAFETY CABLES / CHAINS TO TOW VEHICLE

Attach the safety cables / chains from the trailer to their proper and respective attachment points on the tow vehicle by crossing the right cable /chain beneath the tongue to connect to tow vehicle hitch assembly on the left side of the ball. Attach the left cable / chain by crossing it beneath the tongue to the tow vehicle hitch assembly on the right side of the tow ball.

If the cable / chain assemblies fasten to the tow vehicle hitch assembly with quick-links verify that they are properly sized for capacity, located, attached, and fully tightened.

If the trailer is brake equipped, attach the brake emergency breakaway cable to the tow vehicle hitch assembly.

## IV. ATTACH THE TRAILER ELECTRICAL SYSTEM TO TOW VEHICLE

Examine the trailer to determine required tow vehicle wiring connection: 4-flat, 5-flat, or 7 round.

**NOTICE:** *LOAD RITE trailers are equipped to accept either a 4-flat, 5-flat, or 7-round electrical plug depending on trailer brake system configuration. It is imperative that the proper tow vehicle electrical connection is provided for safe trailer operation.*

Verify tow vehicle is equipped to accept the connector furnished with the trailer. If not, the vehicle will need to be modified by either the boat dealer or vehicle manufacturer dealer.

With boat trailer securely mechanically attached to tow vehicle, attach the trailer wiring harness to the tow vehicle electrical system by inserting trailer connector plug into appropriate tow vehicle plug socket.

Switch tow vehicle lighting selector to either running or headlight position. Verify that all trailer marker and taillights are illuminated. Utilizing a helper, verify turn signal and brake light operation.



If trailer fails to illuminate initially, recheck mechanical attachment and verify proper trailer ground through tow vehicle tow ball.



## TRAILER ADJUSTMENTS (where applicable)

Most LOAD RITE trailers are designed with adjustable features to facilitate optimal hull fitment. Models are designed to adjust to variation in hull width, length and bow design. Due to tremendous industry variation in boat hull design and the universal nature of LOAD RITE trailer designs, some compromises in setup may be required to achieve optimal fit.

***NOTICE: LOAD RITE trailers are adjusted to a neutral position at the factory. At the time of delivery the trailer may require adjustments to assure optimum fit of boat to trailer.***

Below is a brief list of possible adjustment options for most adjustable trailers.

### I. HULL POSITION ON THE TRAILER

Hull position relative to the trailer is very important. This position determines where the boat will sit on the support system. Position the hull on the trailer support system so that the hull is properly supported. There should be little to no contact between bunk or roller contact area and any hull strakes, scuppers, or control surfaces. Adjust support system to avoid interference.

The hull should be adjusted so that the rear of the support system aligns as near the transom as possible. Refer to hull manufacturer for maximum hull transom extension beyond the rear of the support system. The support system may be adjustable fore and aft which may be critical in adjusting tongue weight (see below).

### II. THE WINCH STAND ASSEMBLY

The winch stand assembly is designed to allow for two basic adjustments: bow eye height and hull positioning on the trailer.

To adjust the height, loosen the fasteners clamping the winch support to the winch post. Reposition to the desired height and retighten. Proper winch stand height is determined when the winch line or strap is level with the bow eye of the boat. The winch line should attach to the bow eye after passing beneath the winch roller and should pull the boat toward the winch on a level line.

To adjust for boat hull position, loosen the mounting U-bolts and slide the winch stand along the tongue, either forward or rearward as required, until optimum bow roller to boat hull contact is achieved.

### III. ROLLER POSITIONING

Roller trailers offer a great amount of adjustability to accommodate most boats.

The cross bars, spanning across the trailer between the main frame rails, may offer multiple height positions. Some models may offer more than one longitudinal crossbar position along the frame. The pivot bars run parallel to the frame members and are mounted on brackets atop the cross bars. Pivot bars can be adjusted laterally to suit hull width and chine location requirements. On some models the roller assemblies, mounted at each end of the pivot bar, may offer some adjustability as well.

***NOTICE: Boats with longitudinal strakes or chines should have the rollers adjusted to run on the flat area of the hull between the strakes or chines, avoiding scuppers or control surfaces.***

The rollers should be lubricated at least once a year, preferably at the start of the season, and possibly again during the season depending on the amount of usage and water immersion. Use a dry graphite lubricant to lube the roller hub and bushing.

***CAUTION: The boat should be removed from the trailer while ALL adjustments are being performed. Make certain that all fasteners are properly tightened BEFORE the boat is reloaded onto the trailer.***

### IV. TONGUE WEIGHT

#### ***CRITICAL ITEM!***

Tongue weight can be described as the weight balance of the boat on the trailer and having sufficient amount transferred to the tow vehicle through the ball and coupler to facilitate stable towing.

***CAUTION: Proper tongue weight is critical to trailer handling and safe towing practices.***

Tongue weight should be properly adjusted and set before first trailer use. The boat should be equipped as it will be regularly towed: equipment, gear and fuel onboard. The trailer frame should be level, or parallel to the ground. Once set, further adjustment will only be required if the boat is modified, such as with different motors or additional gear is added.

***NOTICE: Actual tongue weight can be determined using a simple scale per the diagram on page 11.***

There are several adjustments that can be used to alter tongue weight. The first is hull position on the support system as discussed previously. On trailers with fore and aft support system adjustability, tongue weight can be influenced by moving the boat fore or aft in reference to the trailer frame.

On trailers with a movable axle(s), the axle assemblies, spring or torsion, are attached to the main frame with carriage and/or U-bolts. To adjust the tongue weight, loosen the attaching fasteners and slide the axle system as required to remove or add tongue weight. Moving the assemblies forward on the trailer frame will decrease tongue weight while moving the axle rearward will increase tongue weight.

***CAUTION: Be sure not to damage the brake line or wire harness in the process.***

***CAUTION: Axles should never be moved in excess of 6" in either direction without written approval from LOAD RITE.***

Once axle relocation is complete, be certain the axle is perfectly perpendicular to the direction of forward travel and all fasteners are fully tightened.

Verify tongue weight utilizing one of the methods shown on page 11. Recommended tongue weight setting is normally as follows:

- All trailers 2,000 lbs. and under, the tongue weight should equal 7% to 10% of the actual gross weight (GVWR).
- All galvanized trailers over 2,000 lbs., the tongue weight should equal 10% to 12% of the actual gross weight (GVWR).
- All aluminum trailers over 2,000 lbs., the tongue weight should equal 7% of the

actual gross weight (GVWR).

- GVWR can be found on the VIN sticker located on the left (driver's side) frame rail of the trailer.

## DETERMINING TONGUE WEIGHT (TW)

Determine gross trailer weight (GTW), or the **actual** weight of the trailer fully loaded as it would normally be towed. This includes trailer, boat, motor, fuel and accessories and gear. Tongue weight (TW) is the downward force exerted on the hitch ball at the trailer coupler. In most cases, this should range between 7 to 10 percent of GTW.

Tongue weight should be directly measured with a tongue weight scale as shown. If shown tool is unavailable, tongue weights of up to 200 lbs. can be measured on a household scale by resting the trailer coupler on the scale and placing the scale on a block so that the coupler is at its normal towing height with trailer frames level and parallel to the ground. Trailer should be towed with frames level and parallel to the ground at all times.

For heavier tongue weights, place a household scale and a brick or block of wood of equal thickness as the scale upon blocks spaced three feet apart as shown below. Set a length of pipe on each and rest a beam across the pipes. Re-zero the scale to correct for the weight of the beam and pipe. Securely block the trailer wheels. Lower the trailer coupler on the beam as shown, one (1') foot from the brick or wood block and two (2') feet from the scale.

To obtain the actual tongue weight, multiply the scale reading by three (3). For greater tongue weights, place the scale and brick or wood block four (4) feet apart. Lower the coupler on the beam three (3) feet from the scale, then multiply the scale reading by four (4).

**CAUTION:** *Improper tongue weight, or a trailer towed at a frame attitude other than level and parallel to level ground, can lead to improper tire wear and unsafe towing conditions.*

**Tongue Scale Method**  
For direct measurement to 1,000 lb.

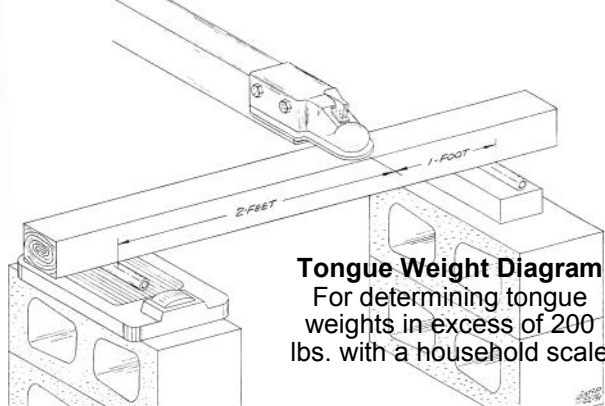

**Tongue Weight Diagram**  
For determining tongue weights in excess of 200 lbs. with a household scale

# AB & AC - Aluminum Bunk Trailer Set-Up

## I. ACHIEVING PROPER TONGUE WEIGHT

Refer to information and diagram on pages 10 and 11.

**NOTICE:** *Proper tongue weight is critical to trailer handling and safe towing practices.*

**NOTICE:** *Actual tongue weight can be determined using method outlined in diagram on page 11.*

**CAUTION:** *The boat should be removed from the trailer while ALL adjustments are being performed. Make certain that all fasteners are properly tightened BEFORE the boat is reloaded onto the trailer.*

## II. SETTING MAIN LOAD BEARING AND TARGET SUPPORT BUNKS

Loosen the target bunk mounting U-bolts and lower all the way down. Leave fasteners loose at this time.

Adjust main load bearing bunk centers as wide as possible while avoiding hull strakes, scuppers, and control surfaces, so that maximum lateral hull support is attained. **Failure to do this could result in unsafe towing conditions.**

## III. ATTACH TRAILER TO TOW VEHICLE

Attach the trailer to the tow vehicle per the information provided on pages 8 and 9.

If the target bunks are taking any load at this time, then the main load bearing bunks must be raised to a higher adjustment position.

## IV. ADJUST THE WINCH STAND

Refer to adjustment procedure on page 9.

## V. SETTING TARGET SUPPORT BUNKS

Raise the target bunks snugly against the keel to achieve a maximum load of approximately 200 lbs. Overloading target bunks can result in trailer frame damage. A hydraulic jack can be used. Tighten bolts and U-Bolts to 45 ft. lbs.

## VI. ADJUSTING AXLES

On trailers with a movable axle(s), the axle assemblies, spring or torsion, are attached to the main frame with carriage and/or U-bolts. To adjust the tongue weight, loosen the attaching fasteners and slide the axle system as required to remove or add tongue weight. Moving the assemblies forward on the trailer frame will decrease tongue weight while moving the axle rearward will increase tongue weight.

**CAUTION:** *Be sure not to damage the brake line or wire harness in the process.*

**CAUTION:** *Axles should never be moved in excess of 6" in either direction without written approval from LOAD RITE.*

# OPERATING INFORMATION AND PRE-TRIP CHECKLIST

**NOTICE:** *Secure the boat to the trailer bow and stern. Do not rely solely on the winch strap to secure the boat to the trailer.*

## I. TOWING VEHICLE INFORMATION

Refer to vehicle manufacturer to determine the proper towing rating for the intended tow vehicle, and that it is properly equipped as a tow vehicle.

**NOTICE:** *Most tow vehicles require a trailer towing package. Make certain that the intended trailer and boat combination GVWR does not exceed tow vehicle rating.*

## II. LAUNCHING THE BOAT

As with towing in general, skill and practice will allow proper handling of a boat at the launch ramp. It is best to practice maneuvering the trailer in an empty parking lot before arriving at the ramp.

Upon arrival at the launch site, stop before reaching the ramp area and remove any tie-downs securing the boat. Prepare the boat as required, and **replace the transom drain plug**, etc. It is recommended that a safety line be attached to the boat so that it can be held in place once in the water.

**CAUTION:** *Do not disconnect the winch line or bow safety chain until the boat is ready for launch.*

Once prepared for launch, slowly back the rig down the ramp to the water. At this point, secure the tow vehicle on the ramp by placing in park and setting the parking brake. Check that the safety line is clear and moved to the proper side of the boat for launching depending on ramp position. Securely hold the winch handle, reverse the winch lock and begin unwinding the strap. Proceed to unfasten the bow safety chain.

**CAUTION:** *Care must be taken at this time to hold the winch handle securely. A free-spinning winch handle can be very dangerous. If the winch handle begins to free-spin, DO NOT attempt to stop it by hand.*

On an average ramp grade, the boat should gently slide back into the water. If the boat does not move, unwind 6 to 8 inches of winch line, lock the winch, and give the boat a shove. Once the boat begins to move / float, securely grasp the winch handle and unlock the winch and wind the boat down into the water.

### III. LOADING AT THE RAMP

As in launching, prepare for loading before reaching the ramp. Back the trailer into the water so that the boat can be floated on.

On full roller trailers it is not necessary to have the boat in perfect alignment with the trailer before loading. Wind and water conditions can affect alignment. Given sufficient time and patience, the boat should self-align as it is being winched onto a roller trailer. Connect the bow safety chain as soon as it reaches the bow hook.

Bunk type trailers are designed to load by floating the boat onto the trailer. The trailer should be submerged so that only the very front of the bunks are visible above water.

Attach the winch strap to the bow eye of the boat and winch the boat the rest of the way onto the trailer. Never allow the winch strap/cable to unreel all the way. Always keep at least 3 turns of the strap/cable around the drum of the winch.

Once the boat is completely on the trailer and the bow safety chain is attached, pull the trailer away from the ramp area, and out of the way of other boat trailers. Proceed to properly secure the boat to the trailer before towing.

**CAUTION:** *Proceed to fully secure the boat to the trailer before exiting the ramp parking lot. The boat should be tied down at the transom and bow, separately from the winch cable/strap.*

### IV. LOADING MISALIGNMENT

Occasionally a boat will load and be misaligned with the trailer centerline. Wind, tide, wake, current, or other environmental conditions could float the hull off trailer center while loading.

Below is a partial list of some other possible causes:

- Trailer support system is not equally spaced from one side of the trailer to the other.
- Ramp is slanted from one side to the other. Angling trailer into the water will sometimes help this situation.
- Boat does not float level in the water in unloaded position.
- Occasionally, a boat hull is not sitting squarely on the assembly jig as it is bolted to the deck. This results in a hull with a slight twist through its longitudinal axis. This situation normally does not affect the performance characteristics of the craft but may result in the appearance of a mis-loaded trailer.

# BRAKE TROUBLESHOOTING

## A. Excessive travel in actuator mechanism:

### Possible cause:

Low fluid in master cylinder reservoir; air in hydraulic lines.

Excessive lining-to-drum clearance.

Leaks in hydraulic lines.

Leaking primary cup in master cylinder; ports closed or restricted with dirt; defective hoses; leaking check valve fails to hold hydraulic pressure.

### Corrective action:

Refill master cylinder and bleed system.

Adjust brakes (drum) or replace linings.

Replace defective lines, bleed, top off.

See Authorized Dealer.

## B. Pressure build-up in hydraulic system:

### Possible cause:

Emergency brake cable pulled.

Contaminated fluid.

Back up solenoid stuck or inoperative.

Defective master cylinder.

Internal hose collapse.

### Corrective action:

Reset emergency brake per manufacturer's instructions.

Drain, flush and replace fluid, replace cups and rubber hoses.

Repair or replace as necessary.

See Authorized Dealer.

See Authorized Dealer.

## C. Brake noise

### Possible cause:

Worn or cracked drum or rotor machined beyond allowable limits.

Vibration with loose bolts, out-of-round drum or rotor.

Shoe/pad clatter, lining coated with grease.

Vibration with loose bearing adjustment or rough bearing action.

### Corrective action:

Replace drum or rotor.

Tighten hub bolts, recondition or replace drum or rotor.

Correct cause of grease leakage, replace pads and grind for proper contact.

Adjust and lubricate bearings or replace.

## D. Brakes lock in reverse

### Possible cause:

Inoperative solenoid (disc brake)

Out of adjustment (drum brake)

### Corrective action:

Check trailer to tow vehicle electrical connection. Replace solenoid.

Adjust linings

# TIRE SAFETY INFORMATION

## **1.1. Tire Safety Information**

This portion of the User's Manual contains tire safety information as required by 49 CFR 575.6.

Section 2.1 contains "Steps for Determining Correct Load Limit - Trailer".

Section 2.2 contains "Steps for Determining Correct Load Limit – Tow Vehicle".

Section 2.3 contains a Glossary of Tire Terminology, including "cold inflation pressure", "maximum inflation pressure", "recommended inflation pressure", and other non-technical terms.

Section 2.4 contains information from the NHTSA brochure entitled "Tire Safety – Everything Rides On It".

This brochure This brochure, as well as the preceding subsections, describes the following items;

- Tire labeling, including a description and explanation of each marking on the tires, and information about the DOT Tire Identification Number (TIN).
  - Recommended tire inflation pressure, including a description and explanation of:
    - A. Cold inflation pressure.
    - B. Vehicle Placard and location on the vehicle.
    - C. Adverse safety consequences of under inflation (including tire failure).
    - D. Measuring and adjusting air pressure for proper inflation.
  - Tire Care, including maintenance and safety practices.
  - Vehicle load limits, including a description and explanation of the following items:
    - A. Locating and understanding the load limit information, total load capacity, and cargo capacity.
    - B. Calculating total and cargo capacities with varying seating configurations including quantitative examples showing / illustrating how the vehicles cargo and luggage capacity decreases as combined number and size of occupants' increases. This item is also discussed in Section 3.
    - C. Determining compatibility of tire and vehicle load capabilities.
    - D. Adverse safety consequences of overloading on handling and stopping on tires.

## **1.2. Steps for Determining Correct Load Limit – Trailer**

Determining the load limits of a trailer includes more than understanding the load limits of the tires alone. On all trailers there is a Federal certification/VIN label that is located on the forward half of the left (road) side of the unit. This certification/VIN label will indicate the trailer's Gross Vehicle Weight Rating (GVWR). This is the most weight the fully loaded trailer can weigh. It will also provide the Gross Axle Weight Rating (GAWR). This is the most a particular axle can weigh. If there are multiple axles, the GAWR of each axle will be provided.

If your trailer has a GVWR of 10,000 pounds or less, there is a vehicle placard located in the same location as the certification label described above. This placard provides tire and loading information. In addition, this placard will show a statement regarding maximum cargo capacity. Cargo can be added to the trailer, up to the maximum weight specified on the placard. The combined weight of the cargo is provided as a single number. In any case, remember: the total weight of a fully loaded trailer can not exceed the stated GVWR.

For trailers with living quarters installed, the weight of water and propane also need to be considered. The weight of fully filled propane containers is considered part of the weight of the trailer before it is loaded with cargo, and is not considered part of the disposable cargo load. Water however, is a disposable cargo weight and is treated as such. If there is a fresh water storage tank of 100 gallons, this tank when filled would weigh about 800 pounds. If more cargo is being transported, water can be off-loaded to keep the total amount of cargo added to the vehicle within the limits of the GVWR so as not to overload the vehicle. Understanding this flexibility will allow you, the owner, to make choices that fit your travel needs.

When loading your cargo, be sure it is distributed evenly to prevent overloading front to back and side to side. Heavy items should be placed low and as close to the axle positions as reasonable. Too many items on one side may overload a tire. The best way to know the actual weight of the vehicle is to weigh it at a public scale. Talk to your dealer to discuss the weighing methods needed to capture the various weights related to the trailer. This would include the weight empty or unloaded, weights per axle, wheel, hitch or king-pin, and total weight.

Excessive loads and/or underinflation cause tire overloading and, as a result, abnormal tire flexing occurs. This situation can generate an excessive amount of heat within the tire. Excessive heat may lead to tire failure. It is the air pressure that enables a tire to support the load, so proper inflation is critical. The proper air pressure may be found on the certification/VIN

label and/or on the Tire Placard. This value should never exceed the maximum cold inflation pressure stamped on the tire.

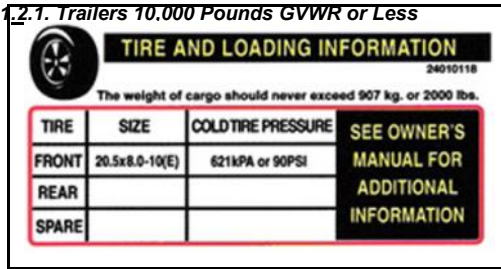

## Tire and Loading Information Placard – Figure 1-1

1. Locate the statement, “The weight of cargo should never exceed XXX kg or XXX lbs.,” on your vehicle’s placard. See figure 1-1.
2. This figure equals the available amount of cargo and luggage load capacity.
3. Determine the combined weight of luggage and cargo being loaded on the vehicle. That weight may not safely exceed the available cargo and luggage load capacity.

The trailer’s placard refers to the Tire Information Placard attached adjacent to or near the trailer’s VIN (Certification) label at the left front of the trailer.

### **1.2.2. Trailers Over 10,000 Pounds GVWR (Note: These trailers are not required to have a tire information placard on the vehicle)**

Determine the empty weight of your trailer by weighing the trailer using a public scale or other means. This step does not have to be repeated.

Locate the GVWR (Gross Vehicle Weight Rating) of the trailer on your trailer’s VIN (Certification) label.

Subtract the empty weight of your trailer from the GVWR stated on the VIN label. That weight is the maximum available cargo capacity of the trailer and may not be safely exceeded.

### **1.3. Steps for Determining Correct Load Limit – Tow Vehicle**

1. Locate the statement, “The combined weight of occupants and cargo should never exceed XXX lbs.,” on your vehicle’s placard.
2. Determine the combined weight of the driver and passengers who will be riding in your vehicle.
3. Subtract the combined weight of the driver and passengers from XXX kilograms or XXX pounds.
4. The resulting figure equals the available amount of cargo and luggage capacity. For example, if the “XXX” amount equals 1400 lbs. and there will be five 150 lb. passengers in your vehicle, the amount of available cargo and luggage capacity is 650 lbs. (1400-750 (5 x 150) = 650 lbs.).
5. Determine the combined weight of luggage and cargo being loaded on the vehicle. That weight may not safely exceed the available cargo and luggage capacity calculated in Step # 4.
6. If your vehicle will be towing a trailer, load from your trailer will be transferred to your vehicle. Consult the tow vehicle’s manual to determine how this weight transfer reduces the available cargo and luggage capacity of your vehicle.

### **1.4. Glossary Of Tire Terminology**

#### **Accessory weight**

The combined weight (in excess of those standard items which may be replaced) of automatic transmission, power steering, power brakes, power windows, power seats, radio and heater, to the extent that these items are available as factory-installed equipment (whether installed or not).

#### **Bead**

The part of the tire that is made of steel wires, wrapped or reinforced by ply cords and that is shaped to fit the rim.

#### **Bead separation**

This is the breakdown of the bond between components in the bead.

#### **Bias ply tire**

A pneumatic tire in which the ply cords that extend to the beads are laid at alternate angles substantially less than 90 degrees to the centerline of the tread.

#### **Carcass**

The tire structure, except tread and sidewall rubber which, when inflated, bears the load.

#### **Chunking**

The breaking away of pieces of the tread or sidewall.

#### **Cold inflation pressure**

The pressure in the tire before you drive.



**Cord**

The strands forming the plies in the tire.

**Cord separation**

The parting of cords from adjacent rubber compounds.

**Cracking**

Any parting within the tread, sidewall, or inner liner of the tire extending to cord material.

**CT**

A pneumatic tire with an inverted flange tire and rim system in which the rim is designed with rim flanges pointed radially inward and the tire is designed to fit on the underside of the rim in a manner that encloses the rim flanges inside the air cavity of the tire.

**Curb weight**

The weight of a motor vehicle with standard equipment including the maximum capacity of fuel, oil, and coolant, and, if so equipped, air conditioning and additional weight optional engine.

**Extra load tire**

A tire designed to operate at higher loads and at higher inflation pressures than the corresponding standard tire.

**Groove**

The space between two adjacent tread ribs.

**Gross Axle Weight Rating**

The maximum weight that any axle can support, as published on the Certification / VIN label on the front left side of the trailer. Actual weight determined by weighing each axle on a public scale, with the trailer attached to the towing vehicle.

**Gross Vehicle Weight Rating**

The maximum weight of the fully loaded trailer, as published on the Certification / VIN label. Actual weight determined by weighing trailer on a public scale, without being attached to the towing vehicle.

**Hitch Weight**

The downward force exerted on the hitch ball by the trailer coupler.

**Innerliner**

The layer(s) forming the inside surface of a tubeless tire that contains the inflating medium within the tire.

**Innerliner separation**

The parting of the innerliner from cord material in the carcass.

**Intended outboard sidewall**

The sidewall that contains a white-wall, bears white lettering or bears manufacturer, brand, and/or model name molding that is higher or deeper than the same molding on the other sidewall of the tire or the outward facing sidewall of an asymmetrical tire that has a particular side that must always face outward when mounted on a vehicle.

**Light truck (LT) tire**

A tire designated by its manufacturer as primarily intended for use on lightweight trucks or multipurpose passenger vehicles.

**Load rating**

The maximum load that a tire is rated to carry for a given inflation pressure.

**Maximum load rating**

The load rating for a tire at the maximum permissible inflation pressure for that tire.

**Maximum permissible inflation pressure**

The maximum cold inflation pressure to which a tire may be inflated.

**Maximum loaded vehicle weight**

The sum of curb weight, accessory weight, vehicle capacity weight, and production options weight.

**Measuring rim**

The rim on which a tire is fitted for physical dimension requirements.

**Pin Weight**

The downward force applied to the 5<sup>th</sup> wheel or gooseneck ball, by the trailer kingpin or gooseneck coupler.

**Non-pneumatic rim**

A mechanical device which, when a non-pneumatic tire assembly incorporates a wheel, supports the tire, and attaches, either integrally or separately, to the wheel center member and upon which the tire is attached.

**Non-pneumatic spare tire assembly**

A non-pneumatic tire assembly intended for temporary use in place of one of the pneumatic tires and rims that are fitted to a passenger car in compliance with the requirements of this standard.

**Non-pneumatic tire**

A mechanical device which transmits, either directly or through a wheel or wheel center member, the vertical load and tractive forces from the roadway to the vehicle, generates the tractive forces that provide the directional control of the vehicle and does not rely on the containment of any gas or fluid for providing those functions.

**Non-pneumatic tire assembly**

A non-pneumatic tire, alone or in combination with a wheel or wheel center member, which can be mounted on a vehicle.

**Normal occupant weight**

This means 68 kilograms (150 lbs.) times the number of occupants specified in the second column of Table I of 49 CFR 571.110.

**Occupant distribution**

The distribution of occupants in a vehicle as specified in the third column of Table I of 49 CFR 571.110.

**Open splice**

Any parting at any junction of tread, sidewall, or innerliner that extends to cord material.

**Outer diameter**

The overall diameter of an inflated new tire.

**Overall width**

The linear distance between the exteriors of the sidewalls of an inflated tire, including elevations due to labeling, decorations, or protective bands or ribs.

**Ply**

A layer of rubber-coated parallel cords.

**Ply separation**

A parting of rubber compound between adjacent plies.

**Pneumatic tire**

A mechanical device made of rubber, chemicals, fabric and steel or other materials, that, when mounted on an automotive wheel, provides the traction and contains the gas or fluid that sustains the load.

**Production options weight**

The combined weight of those installed regular production options weighing over 2.3 kilograms (5 lbs.) in excess of those standard items which they replace, not previously considered in curb weight or accessory weight, including heavy duty brakes, ride levelers, roof rack, heavy duty battery, and special trim.

**Radial ply tire**

A pneumatic tire in which the ply cords that extend to the beads are laid at substantially 90 degrees to the centerline of the tread.

**Recommended inflation pressure**

This is the inflation pressure provided by the vehicle manufacturer on the Tire Information label and on the Certification / VIN tag.

**Reinforced tire**

A tire designed to operate at higher loads and at higher inflation pressures than the corresponding standard tire.

**Rim**

A metal support for a tire or a tire and tube assembly upon which the tire beads are seated.

**Rim diameter**

This means the nominal diameter of the bead seat.

**Rim size designation**

This means the rim diameter and width.

**Rim type designation**

This means the industry of manufacturer's designation for a rim by style or code.

**Rim width**

This means the nominal distance between rim flanges.

**Section width**

The linear distance between the exteriors of the sidewalls of an inflated tire, excluding elevations due to labeling, decoration, or protective bands.

**Sidewall**

That portion of a tire between the tread and bead.

**Sidewall separation**

The parting of the rubber compound from the cord material in the sidewall.

**Special Trailer (ST) tire**

The "ST" is an indication the tire is for trailer use only.

**Test rim**

The rim on which a tire is fitted for testing, and may be any rim listed as appropriate for use with that tire.

**Tread**

That portion of a tire that comes into contact with the road.

**Tread rib**

A tread section running circumferentially around a tire.

**Tread separation**

Pulling away of the tread from the tire carcass.

### **Treadwear indicators (TWI)**

The projections within the principal grooves designed to give a visual indication of the degrees of wear of the tread.

### **Vehicle capacity weight**

The rated cargo and luggage load plus 68 kilograms (150 lbs.) times the vehicle's designated seating capacity.

### **Vehicle maximum load on the tire**

The load on an individual tire that is determined by distributing to each axle its share of the maximum loaded vehicle weight and dividing by two.

### **Vehicle normal load on the tire**

The load on an individual tire that is determined by distributing to each axle its share of the curb weight, accessory weight, and normal occupant weight (distributed in accordance with Table I of CRF 49 571.110) and dividing by 2.

### **Weather side**

The surface area of the rim not covered by the inflated tire.

### **Wheel center member**

In the case of a non-pneumatic tire assembly incorporating a wheel, a mechanical device which attaches, either integrally or separably, to the non-pneumatic rim and provides the connection between the non-pneumatic rim and the vehicle; or, in the case of a non-pneumatic tire assembly not incorporating a wheel, a mechanical device which attaches, either integrally or separably, to the non-pneumatic tire and provides the connection between tire and the vehicle.

### **Wheel-holding fixture**

The fixture used to hold the wheel and tire assembly securely during testing.

## **1.5. Tire Safety - Everything Rides On It**

The National Traffic Safety Administration (NHTSA) has published a brochure (DOT HS 809 361) that discusses all aspects of Tire Safety, as required by CFR 575.6. This brochure is reproduced in part below. It can be obtained and downloaded from NHTSA, free of charge, from the following web site:

[http://www.nhtsa.dot.gov/cars/rules/TireSafety/ridesonit/tires\\_index.html](http://www.nhtsa.dot.gov/cars/rules/TireSafety/ridesonit/tires_index.html)

Studies of tire safety show that maintaining proper tire pressure, observing tire and vehicle load limits (not carrying more weight in your vehicle than your tires or vehicle can safely handle), avoiding road hazards, and inspecting tires for cuts, slashes, and other irregularities are the most important things you can do to avoid tire failure, such as tread separation or blowout and flat tires. These actions, along with other care and maintenance activities, can also:

- Improve vehicle handling
- Help protect you and others from avoidable breakdowns and accidents
- Improve fuel economy
- Increase the life of your tires.

This booklet presents a comprehensive overview of tire safety, including information on the following topics:

- Basic tire maintenance
- Uniform Tire Quality Grading System
- Fundamental characteristics of tires
- Tire safety tips.

Use this information to make tire safety a regular part of your vehicle maintenance routine. Recognize that the time you spend is minimal compared with the inconvenience and safety consequences of a flat tire or other tire failure.

## **1.6. Safety First—Basic Tire Maintenance**

Properly maintained tires improve the steering, stopping, traction, and load-carrying capability of your vehicle. Underinflated tires and overloaded vehicles are a major cause of tire failure. Therefore, as mentioned above, to avoid flat tires and other types of tire failure, you should maintain proper tire pressure, observe tire and vehicle load limits, avoid road hazards, and regularly inspect your tires.

### **1.6.1. Finding Your Vehicle's Recommended Tire Pressure and Load Limits**

Tire information placards and vehicle certification labels contain information on tires and load limits. These labels indicate the vehicle manufacturer's information including:

- Recommended tire size
- Recommended tire inflation pressure
- Vehicle capacity weight (VCW—the maximum occupant and cargo weight a vehicle is designed to carry)
- Front and rear gross axle weight ratings (GAWR—the maximum weight the axle systems are designed to carry).

Both placards and certification labels are permanently attached to the trailer near the left front.

### **1.6.2. Understanding Tire Pressure and Load Limits**

Tire inflation pressure is the level of air in the tire that provides it with load-carrying capacity and affects the overall performance of the vehicle. The tire inflation pressure is a number that indicates

the amount of air pressure— measured in pounds per square inch (psi)—a tire requires to be properly inflated. (You will also find this number on the vehicle information placard expressed in kilopascals (kpa), which is the metric measure used internationally.)

Manufacturers of passenger vehicles and light trucks determine this number based on the vehicle's design load limit, that is, the greatest amount of weight a vehicle can safely carry and the vehicle's tire size. The proper tire pressure for your vehicle is referred to as the "recommended cold inflation pressure." (As you will read below, it is difficult to obtain the recommended tire pressure if your tires are not cold.)

Because tires are designed to be used on more than one type of vehicle, tire manufacturers list the "maximum permissible inflation pressure" on the tire sidewall. This number is the greatest amount of air pressure that should ever be put in the tire under normal driving conditions.

### **1.6.3. Checking Tire Pressure**

It is important to check your vehicle's tire pressure at least once a month for the following reasons:

- Most tires may naturally lose air over time.
- Tires can lose air suddenly if you drive over a pothole or other object or if you strike the curb when parking.
- With radial tires, it is usually not possible to determine underinflation by visual inspection.

For convenience, purchase a tire pressure gauge to keep in your vehicle. Gauges can be purchased at tire dealerships, auto supply stores, and other retail outlets.

The recommended tire inflation pressure that vehicle manufacturers provide reflects the proper psi when a tire is cold. The term cold does not relate to the outside temperature. Rather, a cold tire is one that has not been driven on for at least three hours. When you drive, your tires get warmer, causing the air pressure within them to increase. Therefore, to get an accurate tire pressure reading, you must measure tire pressure when the tires are cold or compensate for the extra pressure in warm tires.

### **1.6.4. Steps for Maintaining Proper Tire Pressure**

- Step 1: Locate the recommended tire pressure on the vehicle's tire information placard, certification label, or in the owner's manual.
- Step 2: Record the tire pressure of all tires.
- Step 3: If the tire pressure is too high in any of the tires, slowly release air by gently pressing on the tire valve stem with the edge of your tire gauge until you get to the correct pressure.
- Step 4: If the tire pressure is too low, note the difference between the measured tire pressure and the correct tire pressure. These "missing" pounds of pressure are what you will need to add.
- Step 5: At a service station, add the missing pounds of air pressure to each tire that is underinflated.
- Step 6: Check all the tires to make sure they have the same air pressure (except in cases in which the front and rear tires are supposed to have different amounts of pressure).

If you have been driving your vehicle and think that a tire is underinflated, fill it to the recommended cold inflation pressure indicated on your vehicle's tire information placard or certification label. While your tire may still be slightly underinflated due to the extra pounds of pressure in the warm tire, it is safer to drive with air pressure that is slightly lower than the vehicle manufacturer's recommended cold inflation pressure than to drive with a significantly underinflated tire. Since this is a temporary fix, don't forget to recheck and adjust the tire's pressure when you can obtain a cold reading.

### **1.6.5. Tire Size**

To maintain tire safety, purchase new tires that are the same size as the vehicle's original tires or another size recommended by the manufacturer. Look at the tire information placard, the owner's manual, or the sidewall of the tire you are replacing to find this information. If you have any doubt about the correct size to choose, consult with the tire dealer.

### **1.6.6. Tire Tread**

The tire tread provides the gripping action and traction that prevent your vehicle from slipping or sliding, especially when the road is wet or icy. In general, tires are not safe and should be replaced when the tread is worn down to 1/16 of an inch. Tires have built-in treadwear indicators that let you know when it is time to replace your tires. These indicators are raised sections spaced intermittently in the bottom of the tread grooves. When they appear "even" with the outside of the tread, it is time to replace your tires. Another method for checking tread depth is to place a penny in the tread with Lincoln's head upside down and facing you. If you can see the top of Lincoln's head, you are ready for new tires.

### **1.6.7. Tire Balance and Wheel Alignment**

To avoid vibration or shaking of the vehicle when a tire rotates, the tire must be properly balanced. This balance is achieved by positioning weights on the wheel to counterbalance heavy spots on the wheel-and-tire assembly. A wheel alignment adjusts the angles of the wheels so that they are positioned correctly relative to the vehicle's frame. This adjustment maximizes the life of your tires. These adjustments require special equipment and should be performed by a qualified technician.

### 1.6.8. Tire Repair

The proper repair of a punctured tire requires a plug for the hole and a patch for the area inside the tire that surrounds the puncture hole. Punctures through the tread can be repaired if they are not too large, but punctures to the sidewall should not be repaired. Tires must be removed from the rim to be properly inspected before being plugged and patched.

### 1.6.9. Tire Fundamentals

Federal law requires tire manufacturers to place standardized information on the sidewall of all tires. This information identifies and describes the fundamental characteristics of the tire and also provides a tire identification number for safety standard certification and in case of a recall.

#### 1.6.9.1 Information on Passenger Vehicle Tires

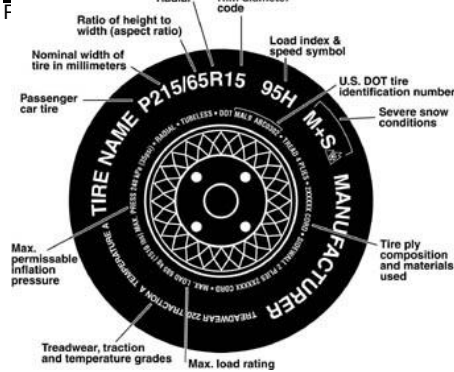

#### P

The "P" indicates the tire is for passenger vehicles. (Trailer tires will carry the "ST" indication, for Special Trailer service.)

#### Next number

This three-digit number gives the width in millimeters of the tire from sidewall edge to sidewall edge. In general, the larger the number, the wider the *tire*.

#### Next number

This two-digit number, known as the aspect ratio, gives the tire's ratio of height to width. Numbers of 70 or lower indicate a short sidewall for improved steering response and better overall handling on dry *pavement*.

#### R

The "R" stands for radial. Radial ply construction of tires has been the industry standard for the past 20 years.

#### Next number

This two-digit number is the wheel or rim diameter in inches. If you change your wheel size, you will have to purchase new tires to match the new wheel *diameter*.

#### Next number

This two- or three-digit number is the tire's load index. It is a measurement of how much weight each tire can support. You may find this information in your owner's manual. If not, contact a local tire dealer. Note: You may not find this information on all tires because it is not required by law.

#### M+S

The "M+S" or "M/S" indicates that the tire has some mud and snow capability. Most radial tires have these markings; hence, they have some mud and snow *capability*.

Letter Rating	Speed Rating
Q	99 mph
R	106 mph
S	112 mph
T	118 mph
U	124 mph
H	130 mph
V	149 mph
W	168* mph
Y	186* mph

### Speed Rating

The speed rating denotes the speed at which a tire is designed to be driven for extended periods of time. The ratings range from 99 miles per hour (mph) to 186 mph. These ratings are listed below.

Note: You may not find this information on all tires because it is not required by law.

\* For tires with a maximum speed capability over 149 mph, tire manufacturers sometimes use the letters ZR. For those with a maximum speed capability over 186 mph, tire manufacturers always use the letters ZR.

### U.S. DOT Tire Identification Number

This begins with the letters "DOT" and indicates that the tire meets all federal standards. The next two numbers or letters are the plant code where it was manufactured, and the last four numbers represent the week and year the tire was built. For example, the numbers 3197 means the 31st week of 1997. The other numbers are marketing codes used at the manufacturer's discretion. This information is used to contact consumers if a tire defect requires a recall.

### Tire Ply Composition and Materials Used

The number of plies indicates the number of layers of rubber-coated fabric in the tire. In general, the greater the number of plies, the more weight a tire can support. Tire manufacturers also must indicate the materials in the tire, which include steel, nylon, polyester, and others.

### Maximum Load Rating

This number indicates the maximum load in kilograms and pounds that can be carried by the tire.

### Maximum Permissible Inflation Pressure

This number is the greatest amount of air pressure that should ever be put in the tire under normal driving conditions.

### 1.6.9.2. UTQGS Information

#### Treadwear Number

This number indicates the tire's wear rate. The higher the treadwear number is, the longer it should take for the tread to wear down. For example, a tire graded 400 should last twice as long as a tire graded 200.

#### Traction Letter

This letter indicates a tire's ability to stop on wet pavement. A higher graded tire should allow you to stop your car on wet roads in a shorter distance than a tire with a lower grade. Traction is graded from highest to lowest as "AA", "A", "B", and "C".

#### Temperature Letter

This letter indicates a tire's resistance to heat. The temperature grade is for a tire that is inflated properly and not overloaded. Excessive speed, underinflation or excessive loading, either separately or in combination, can cause heat build-up and possible tire failure. From highest to lowest, a tire's resistance to heat is graded as "A", "B", or "C".

### 1.6.9.3. Additional Information on Light Truck Tires

Please refer to the following diagram.



Tires for light trucks have other markings besides those found on the sidewalls of passenger tires.

**LT** - The "LT" indicates the tire is for light trucks or trailers.

**ST** - An "ST" is an indication the tire is for trailer use only.

**Max. Load Dual kg (lbs) at kPa (psi) Cold**

This information indicates the maximum load and tire pressure when the tire is used as a dual, that is, when four tires are put on each rear axle (a total of six or more tires on the vehicle).

**Max. Load Single kg (lbs) at kPa (psi) Cold**

This information indicates the maximum load and tire pressure when the tire is used as a single.

**Load Range**

This information identifies the tire's load-carrying capabilities and its inflation limits.

**1.7. Tire Safety Tips**

**Preventing Tire Damage**

- Slow down if you have to go over a pothole or other object in the road.
- Do not run over curbs or other foreign objects in the roadway, and try not to strike the curb when parking.

**Tire Safety Checklist**

- Check tire pressure regularly (at least once a month), including the spare.
- Inspect tires for uneven wear patterns on the tread, cracks, foreign objects, or other signs of wear or trauma.
- Remove bits of glass and foreign objects wedged in the tread.
- Make sure your tire valves have valve caps.
- Check tire pressure before going on a long trip.
- Do not overload your vehicle. Check the Tire Information and Loading Placard or User's Manual for the maximum recommended load for the vehicle.

## WARRANTY INFORMATION

If you experience any difficulties or defects with parts of the trailer, please look for the manufacturer's name on the part and contact them directly. The following is a list of Load Rite's current vendors from whom parts are purchased:

Vendor	Part Description	Phone Number
Autoflex - Knott	Torsion Axles, Tongue Jacks	1-920-928-6875
C.E. Smith Co.	Stampings, Aluminum Fenders	1-800 334-2490
C.H. Yates Rubber Corp.	Rubber Rollers	1-508-674-3378
Horizon Global	Plastic Fenders	1-715-693-1700
Dexter Marine	Actuators, Torsion Axles	1-404-477-6899
Dutton-Lainson	Tongue Jacks, Couplers, Winches	1-888-489-1064
Kenda / LOADSTAR	Tires	1-800-225-4714
Peterson	Lighting	1-800-821-3490
Peerless Chain	Safety Chains	1-800-533-8056
Tecniq Inc.	LED Lighting	1-269-629-4440
Tie Down Engineering	Stampings, Aluminum Fenders, Rollers	1-800-241-1806
UFP by Dexter	Torsion Axles	1-800-835-9211

LOAD RITE Trailers, Inc.  
265 Lincoln Highway  
Fairless Hills, PA 19030  
215-949-0500  
[www.loadrite.com](http://www.loadrite.com)

