



# Tiller/Cultivator

## *Operator's Manual*

**MODEL TC-210**

**Serial Number 07001001 - 07999999**

**WARNING ! DANGER**



The muffler or catalytic muffler and surrounding cover may become extremely hot.



Always keep clear of exhaust and muffler area, otherwise serious personal injury may occur.



**WARNING**



The engine exhaust from this product contains chemicals known to the State of California to cause cancer, birth defects or other reproductive harm.



**WARNING ! DANGER**

Read rules for safe operation and instructions carefully. ECHO provides an Operator's Manual, which must be read and understood for proper and safe operation.

X7504082600

X750004470  
03/02

## INTRODUCTION

Welcome to the ECHO family. This ECHO product was designed and manufactured to provide long life and on-the-job-dependability. Read and understand this manual that you found in the package. You will find it easy to use and full of helpful operations tips and SAFETY messages.

## THE OPERATOR'S MANUAL

Read and understand this manual before operation. Keep it in a safe place for future reference. It contains specifications and information for operation, starting, stopping, maintenance, storage and assembly specific to this product.

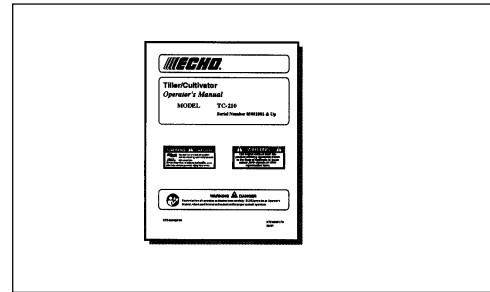

## TABLE OF CONTENTS

Introduction .....	2	Maintenance .....	14
- The Operator's Manual .....	2	- Skill Levels .....	14
Manual Safety Symbols and Important Information .....	3	- Maintenance Intervals .....	14
Safety .....	3	- Air Filter .....	15
- Decals .....	3	- Fuel Filter .....	15
- International Symbols .....	4	- Spark Plug .....	16
Safety Instructions .....	4	- Cooling System Cleaning .....	16
- Personal Condition and Safety Equipment .....	4	- Exhaust System .....	17
- Extended Operation/Extreme Conditions .....	5	- Carburetor Adjustment .....	18
- Equipment .....	5	- Lubrication .....	19
- Safe Operation .....	6	Troubleshooting .....	20
Emission Control .....	6	Storage .....	21
Description .....	7	Servicing Information .....	24
- Contents .....	7	- Parts .....	24
Specifications .....	9	- Service .....	24
Assembly .....	10	- ECHO Consumer Product Support .....	24
Pre-Operation .....	11	- Warranty Card .....	24
- Fuel .....	11	- Additional or Replacement Manuals .....	24
Operation .....	12		
- Starting Cold Engine .....	12		
- Starting Warm Engine .....	13		
- Stopping Engine .....	13		

Specifications, descriptions and illustrative material in this literature are as accurate as known at the time of publication, but are subject to change without notice. Illustrations may include optional equipment and accessories, and may not include all standard equipment.

## SAFETY SYMBOLS AND IMPORTANT INFORMATION

Throughout this manual and on the product itself, you will find safety alerts and helpful, information messages preceded by symbols or key words. The following is an explanation of those symbols and key words and what they mean to you.



This symbol accompanied by the words **WARNING** and **DANGER** calls attention to an act or condition that can lead to serious personal injury to operator and bystanders.



The circle with the slash symbol means whatever is shown within the circle is prohibited.

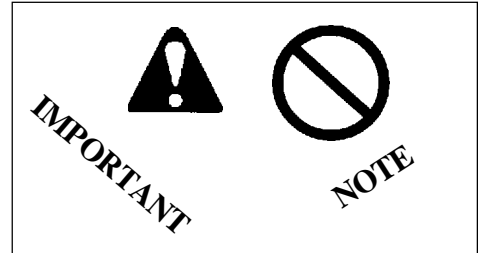

**IMPORTANT** The enclosed message provides information necessary for the protection of the unit.

**NOTE** This enclosed message provides tips for use, care and maintenance of the unit.

## SAFETY DECALS

Locate these safety decals on your unit. The complete unit illustration found in the "DESCRIPTION" section, will help you locate them. Make sure the decals are legible and that you understand and follow the instructions on them. If a decal cannot be read, a new one can be ordered from your ECHO dealer. See PARTS ORDERING instructions for specific information.

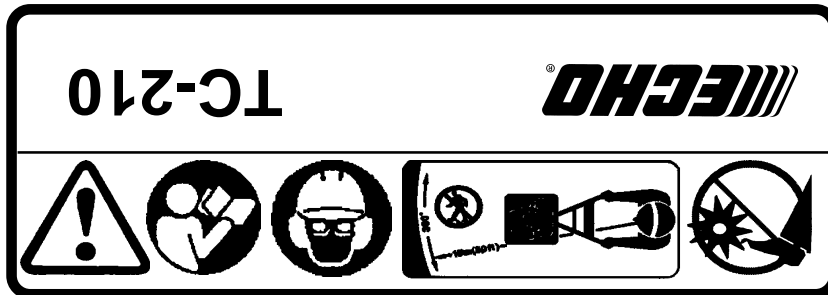

P/N X505001100

P/N 89016811760



## INTERNATIONAL SYMBOLS

Symbol form/shape	Symbol description/application	Symbol form/shape	Symbol description/application
	Read and understand Operator's Manual.		Fuel and oil mixture
	Wear eyes, ears and head protection		Finger Severing
	Hot Surface		Wear hand protection. Use two handed.
	Wear slip resistant foot wear.		DO NOT smoke near fuel.
	Safety/Alert		DO NOT allow flames or sparks near fuel.

Symbol form/shape	Symbol description/application	Symbol form/shape	Symbol description/application
	Avoid all power lines. This unit is not insulated against electrical current.		Emergency stop
	Engine choke control.		Ignition ON/OFF
	Primer bulb		Carburetor adjustment - High speed mixture
	Carburetor adjustment - Low speed mixture		Carburetor adjustment - Idle speed

## SAFETY INSTRUCTION

### PERSONAL CONDITION AND SAFETY EQUIPMENT

## WARNING DANGER

Tiller/Cultivator users risk injury to themselves and others if the tiller/cultivator is used improperly and or safety precautions are not followed. Proper clothing and safety gear must be worn when operating a tiller/cultivator. Failure to do so can result in serious injury.

#### ***Physical Condition --***

Your judgment and physical dexterity may not be good:

- if you are sick,
- if you are taking medication,
- if you have taken alcohol or drugs.

Operate unit only if you are physically and mentally well.

#### ***Eye Protection --***

Wear Eye protection that meet ANSI Z87.1 or CE requirements whenever you operate the unit.

#### ***Hand Protection --***

Wear no-slip, heavy duty work gloves in improve your grip on the Tiller/Cultivator handles. Gloves also reduce the transmission of machine vibration to your hands.

#### ***Hearing Protection --***

ECHO recommends wearing hearing protection whenever unit is used.

#### ***Proper Clothing --***

Wear snug fitting, durable clothing;

- Pants should have long legs, shirts with long sleeves.
- Wear hair covering to contain long hair.
- **DO NOT WEAR SHORTS,**
- **DO NOT WEAR TIES, SCARFS, JEWELRY.**

Wear sturdy work shoes with non-skid soles;

- **DO NOT WEAR OPEN TOED SHOES,**
- **DO NOT OPERATE UNIT BAREFOOTED.**

Wear no-slip, heavy duty work gloves.

#### ***Hot Humid Weather --***

Heavy protective clothing can increase operator fatigue which may lead to heat stroke. Schedule heavy work for early morning or late afternoon hours when temperatures are cooler.

**EXTENDED OPERATION/EXTREME CONDITIONS**

***Vibration and Cold --***

It is believed that a condition called Raynaud's Phenomenon, which affects the fingers of certain individuals may be brought about by exposure to vibration and cold. Exposure to vibration and cold may cause tingling and burning sensations followed by loss of color and numbness in the fingers. The following precautions are strongly recommended because the minimum exposure which might trigger the ailment is unknown.

- Keep your body warm, especially the head, neck, feet, ankles, hands and wrists.
- Maintain good blood circulation by performing vigorous arm exercises during frequent work breaks and also by not smoking.
- Limit the hours of operation. Try to fill each day with jobs where operating the trimmer or other hand-held power equipment is not required.
- If you experience discomfort, redness and swelling of the fingers followed by whitening and loss of feeling, consult your physician before further exposing yourself to cold and vibration.

***Repetitive Stress Injuries --***

It is believed that overusing the muscles and tendons of the fingers, hands, arms and shoulders may cause soreness, swelling, numbness, weakness and extreme pain in those areas. Certain repetitive hand activities may put you at a high risk for developing a Repetitive Stress Injury (RSI). An extreme RSI condition is Carpal Tunnel Syndrome (CTS), which could occur when your wrist swells and squeezes a vital nerve that runs through the area. Some believe that prolonged exposure to vibration may contribute to CTS. CTS can cause severe pain for months or even years.

To reduce the risk of RSI/CTS, do the following:

- Avoid using your wrist in a bent, extended or twisted position. Instead try to maintain a straight wrist position. Also, when grasping, use your whole hand, not just the thumb and index finger.
- Take periodic breaks to minimize repetition and rest your hands.
- Reduce the speed & force in which you do the repetitive movement.
- Do exercises to strengthen the hand and arm muscles.
- Immediately stop using all power equipment and consult a doctor if you feel tingling, numbness or pain in the fingers, hands, wrists or arms. The sooner RSI/CTS is diagnosed, the more likely permanent nerve and muscle damage can be prevented.

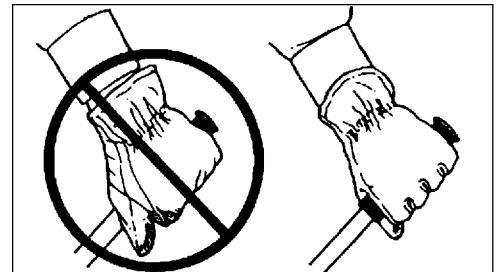

**EQUIPMENT**

Before operation a complete check of the unit must be performed;

- Check unit for loose/missing nuts, bolts and screws. Tighten and/or replace as needed.
- Inspect fuel lines, tank and area around carburetor for fuel leaks. DO NOT operate unit if leaks are found.
- Inspect shield for damage and ensure that the shield is securely in place. Replace if shield is damaged or missing.
- Check that the tines are firmly attached and in safe operating condition.
- Keep exhaust area clear of flammable debris. Avoid contact during and immediately after operation.

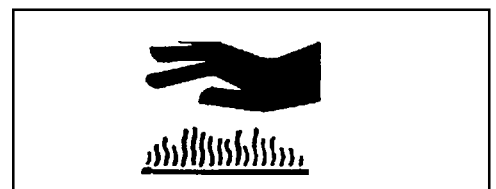

## SAFE OPERATION

### WARNING DANGER

Do not operate this product indoors or in inadequately ventilated areas. Engine exhaust contains poisonous emissions and can cause serious injury or death.

- Provide all operators of this equipment with the Operator's Manual, and instructions for safe operation.
- Review the area to be tilled. Look for hazards that could contribute to unsafe conditions.
- Spectators and fellow workers must be warned, and children and animals prevented from coming nearer than 15m (50 ft.) while the tiller/cultivator is in use.
- Do not operate this product indoors or in inadequately ventilated areas.



## EMISSION CONTROL

### *EPA Phase 2*

The emission control system for these engines are EM (Engine Modification).

**IMPORTANT ENGINE INFORMATION**  
ENGINE FAMILY : 2EHXS.0214ED DISPLACEMENT : 21.2cc  
EMISSION COMPLIANCE PERIOD: 300 HOURS  
THIS ENGINE MEETS U.S. EPA PH 2 EMISSION  
REGULATIONS FOR SMALL NONROAD ENGINE. REFER  
TO OWNER'S MANUAL FOR MAINTENANCE SPECIFICA-  
TIONS AND ADJUSTMENTS.



**Emission Control Label** (located on Engine) (EXAMPLE ONLY, information on label varies by FAMILY).

### PRODUCT EMISSION DURABILITY

The 300 hour emission durability compliance period is the time span selected by the manufacturer certifying the engine emissions output meets applicable emissions regulations, provided that approved maintenance procedures are followed as listed in the Maintenance Section of this manual.

## DESCRIPTION

The ECHO product you purchased has been factory pre-assembled for your convenience. Due to packaging restrictions some assembly is required.

After opening the carton, check for damage. Immediately notify your retailer or ECHO Dealer of damaged or missing parts. Use the contents list to check for missing parts.

## CONTENTS

- \_\_\_\_\_ 1 - Power Head & Shield Assembly
- \_\_\_\_\_ 1 - Upper Handle Assembly
- \_\_\_\_\_ 1 - Left Lower Handle
- \_\_\_\_\_ 1 - Right Lower Handle
- \_\_\_\_\_ 2 - Lower Handle Mounting Brackets
- \_\_\_\_\_ 1 - Plastic Bag (Co-Pack)
- \_\_\_\_\_ - 1, 1/4" x 3" Hex Head Shoulder Bolt
- \_\_\_\_\_ - 1, 1/4" x 3-1/4" Hex Head Shoulder Bolt
- \_\_\_\_\_ - 2, 1/4" Lock Washers
- \_\_\_\_\_ - 2, 1/4" Lock Nuts
- \_\_\_\_\_ - Carry Handle
- \_\_\_\_\_ - Cable Tie
- \_\_\_\_\_ - Operator's Manual
- \_\_\_\_\_ - Warranty Card & Limited  
Warranty Statement
- \_\_\_\_\_ - Hardware Bag
- \_\_\_\_\_ - 2, 10mm x 30mm Carriage Bolt
- \_\_\_\_\_ - 2, 10mm nut
- \_\_\_\_\_ - 2, 10mm Lock Washer
- \_\_\_\_\_ - Bottle 2-Cycle Engine Oil

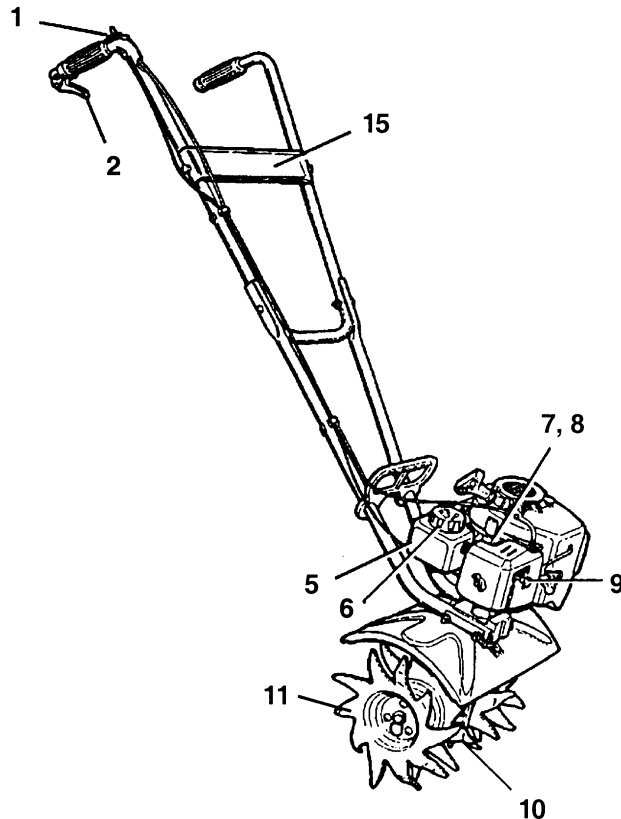
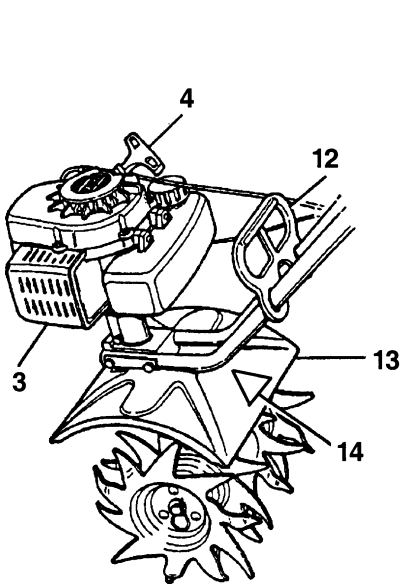
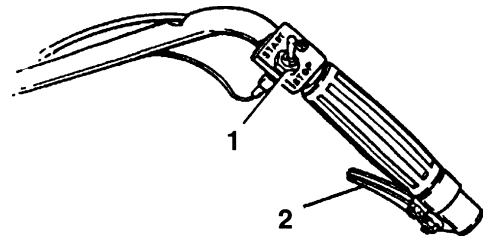
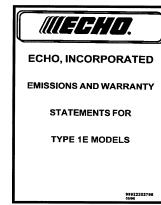
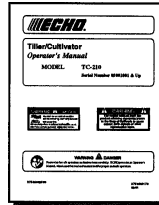

1. **STOP SWITCH** - "Toggle Switch" mounted on top of Throttle Trigger Housing. Move switch Forward to Run, Back to Stop.
2. **THROTTLE TRIGGER** - Spring loaded to return to idle when released. When accelerating, pull trigger gradually for best operating technique. DO NOT hold trigger when starting.
3. **MUFFLER/SPARK ARRESTOR** - The muffler controls the exhaust noise while the spark arrestor prevent hot, glowing particles of carbon from leaving the muffler where they could possibly start a fire.
4. **RECOIL STARTER HANDLE** - Pull recoil handle slowly until starter engages, then pull quickly and firmly. When engine starts, return handle slowly. DO NOT let handle snap back or damage to unit will occur.
5. **FUEL TANK** - Contains fuel and fuel filter.
6. **FUEL TANK CAP** - Cover and seals fuel tank opening.
7. **PRIMER BULB** - Pumping primer bulb before starting engine draws fresh fuel from the fuel tank priming the carburetor for starting. Pump primer bulb until fuel is visible and flows freely in the clear fuel tank return line. Pump bulb an additional 4 or 5 times.
8. **AIR CLEANER** - Contains replaceable filter element.
9. **CHOKE** - The choke control is located on the side of the air filter case. Move choke to "COLD START" to close the choke for cold starting. Move choke to "RUN" position to open choke.
10. **GEAR BOX** - Houses gears for driving tines.
11. **TINES** - Used to till or cultivate soil. Removable for cleaning.
12. **CARRYING HANDLE** - Use for convenient transportation.
13. **TINE GUARD** - Used to help deflect debris away from operator and reduce accidental contact of tines.
14. **SAFETY DECAL** - See Description on Page 4.
15. **SAFETY DECAL** - See Description on Page 4.



**SPECIFICATIONS**

**MODEL ----- TC-210**

Length ----- 1130mm(44.48in.)

Width ----- 340mm(13.36in.)

Height ----- 1010mm(39.76in.)

Weight (dry) w/Tines ----- 8.62kg (19lb.)

Engine Type ----- Air cooled, two-stroke, single cylinder gasoline engine

Bore ----- 32.2mm(1.268in.)

Stroke ----- 26.0mm(1.04in.)

Displacement ----- 21.2 cc (1.29 cu. in.)

Exhaust ----- Spark Arrestor Muffler

Carburetor ----- Zama diaphragm model C1U w/primer bulb

Ignition System ----- Flywheel magneto, capacitor discharge ignition type

Spark Plug ----- NGKBPMR-8Y Gap0.65 mm(0.026in.)

Fuel ----- Mixed (Gasoline and Two-stroke Oil)

Fuel/Oil Ratio ----- 50:1 ECHO High Performance, two-stroke air cooled engine oil

Gasoline ----- 89 Octane unleaded. DO NOT use fuel containing methyl alcohol,  
more than 10% ethyl alcohol or 15% MTBE.

Oil ----- 50:1 ECHO High Performance, two-stroke air cooled engine oil

Fuel Tank Capacity ----- 0.5 lit. (17.0 US fl. oz.)

Recoil Starter System ----- Automatic Rewind Starter

Clutch ----- Centrifugal Type

Gear Case ----- Worm Gear Type (42:1 Ratio)

Tines ----- Special 10 Tooth Design  
•229 mm (9 in.) Cultivating swath 1/4 tines  
•229 mm(9 in.) Diameter

Idle Speed ----- 2700- 3300RPM

Wide Open Throttle Speed (W.O.T.) ----- 9,000- 11,000RPM

**IMPORTANT** This spark ignition system system complies with Canadian ICES-002.

## ASSEMBLY

*Tools Required:* (2) 11mm (7/16in.) Wrenches

1. Support powerhead assembly upright on tines. Place top handle assembly to rear.
2. Loosely assemble lower handles using 6.35 x 76mm (1/4in. x 3in.) hex head shoulder bolt (A), lockwasher (B), and locknut (C) in front handle end mounting hole as shown.
3. Slide open end of lower handle assembly, front to rear, beneath powerhead and throttle linkage/ignition wires.
4. Place handle tubes into gearcase handle mounting grooves and assemble using 6.35 x 82.5mm (1/4in. x 3-1/4in) hex head shoulder bolt (D), lockwasher (B), and locknut (C) in rear handle mounting holes. **DO NOT TIGHTEN BOLTS.**
5. Slide carry handle onto lower handle tubes.
6. Place top handle assembly between lower handles, align mounting holes and install (2) 10 x 30mm carriage bolts (E), (2) lockwashers (F), and (2) nuts (G). Carriage bolts should be installed from the outside through the lower handle then upper handle tube.
7. Securely tighten lower handle bolts first, then the upper handle bolts.
8. Secure throttle linkage and stop switch lead midway on right lower handle with cable tie.

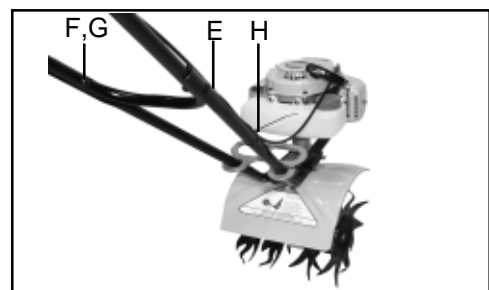
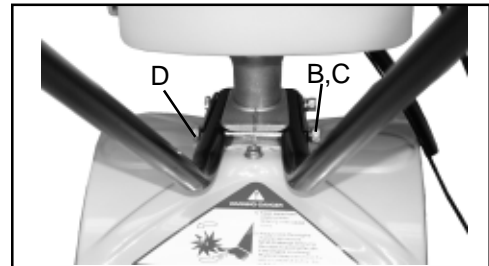
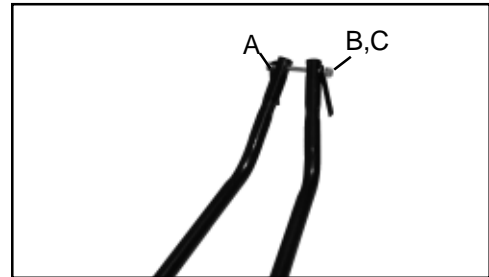

## PRE-OPERATION FUEL

### *Fuel Requirements*

**Gasoline** - Use 89 Octane [ $\frac{R+M}{2}$ ] (mid grade or higher) gasoline known to be good quality. Gasoline may contain up to 15% MTBE (methyl tertiary-butyl ether). Gasohol containing methyl (wood) alcohol is **NOT** approved.

**Two Stroke Oil** - A two-stroke engine oil meeting ISO-L-EGD (ISO/CD 13738) and J.A.S.O. FC Standards, must be used. Echo brand Premium 50:1 oil meets these standards. Engine problems due to inadequate lubrication caused by failure to use an ISO-L-EGD and J.A.S.O. FC certified oil, such as Echo Premium 50:1 Two-stroke Oil, will void the two-stroke engine warranty. (Emission related parts only are covered for two years, regardless of two-stroke oil used, per the statement listed in the Emission Defect Warranty Explanation.)

#### **IMPORTANT**

Echo Premium 2-Stroke Oil may be mixed at 50:1 ratio for application in all Echo engines sold in the past regardless of ratio specified in those manuals.

#### Mixing Instructions

1. Fill an approved fuel container with half of the required amount of gasoline.
2. Add 2-stroke oil to gasoline.
3. Close container and shake to mix oil with gasoline.
4. Add remaining gasoline and remix.
5. Install fuel container cap and wipe any spilled fuel from container and surrounding area.

### *Handling Fuel*

#### **WARNING DANGER**

**Fuel is VERY flammable. Use extreme care when mixing, storing or handling, or serious personal injury may result.**

- Use an approved fuel container.
- **DO NOT** smoke near fuel.
- **DO NOT** allow flames or sparks near fuel.
- Fuel tanks/cans may be under pressure. Always loosen fuel caps slowly allowing pressure to equalize.
- **NEVER** refuel a unit when the engine is **HOT!**
- **NEVER** refuel a unit with the engine running.
- **DO NOT** fill fuel tanks indoors. **ALWAYS** fill fuel tanks outdoors over bare ground.
- Securely tighten fuel cap after refueling.
- Inspect for fuel leakage. If fuel leakage is found, do not start or operate unit until leakage is repaired.

#### **IMPORTANT**

Spilled fuel is a leading cause of hydrocarbon emissions. Some states may require the use of automatic fuel shut-off containers to reduce fuel spillage. Contact your ECHO dealer for ordering information.

#### *After Refueling;*

- Wipe any spilled fuel from the unit.
- Move at least 3 m (10 ft.) from refueling location before starting the engine.

#### *After use;*

- **DO NOT** store a unit with fuel in its tank. Leaks can occur. Return unused fuel to an approved fuel storage container.

#### *Storage -*

Fuel storage laws vary by locality. Contact your local government for the laws affecting your area. As a precaution, store fuel in an approved, air tight container. Store in a well ventilated, unoccupied building, away from sparks and flames. Do not store fuel longer than 30 days.

#### **IMPORTANT**

Stored fuel ages. Do not mix more fuel than you expect to use in thirty (30) days, ninety (90) days when a fuel stabilizer is added.

#### **IMPORTANT**

Stored two-stroke fuel may separate. **ALWAYS** shake fuel container thoroughly before each use.

## OPERATION

- Provide all operators of this equipment with the Operator's Manual and instructions for safe operation.
- Before starting the unit, equip yourself and any other person working within the 15M (50 ft.) Safety Zone with the required Protective Equipment and clothing.
- During operation, the complete unit, especially the engine and the gear housing may become very hot, too hot to touch. Avoid contact during and immediately after operation.
- Do not operate this product indoors or in inadequately ventilated areas.

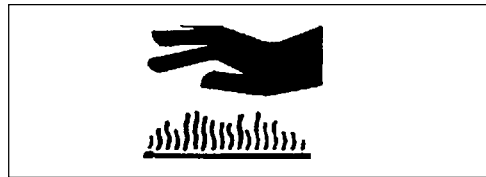

## STARTING COLD ENGINE

### WARNING DANGER

The tines should not move at idle. If tines move, readjust carburetor according to "Carburetor Adjustment" instructions in this manual or see your ECHO Dealer, otherwise serious personal injury may result.

1. *Stop Switch*  
Move Stop Switch (A) to START position.
2. *Choke*  
Move choke (B) to START (closed) position. Throttle must remain at idle for starting.
3. *Primer*  
Pump primer bulb (C) until fuel is visible and flows freely in the clear fuel tank return line. Pump bulb an additional 4 or 5 times.

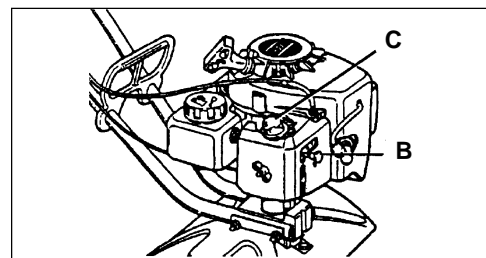
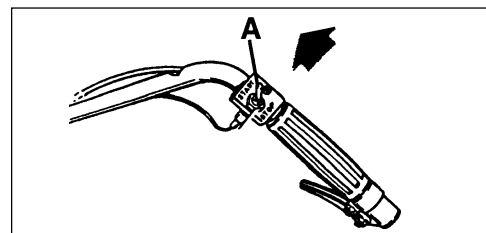

4. *Recoil Starter*  
Pull recoil starter rope until engine fires.
5. *Choke*  
Move choke (B) to RUN (open) position.
6. *Recoil Starter*  
Pull recoil starter rope until engine fires.

## WARNING DANGER

When engine starts, the tines may move even with the throttle trigger in idle (released) position.

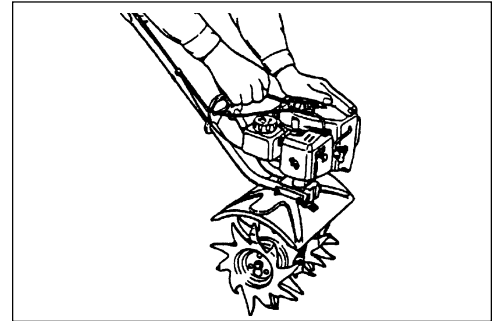

## STARTING WARM ENGINE

The starting procedure is the same as Cold Start except DO NOT close the choke (B).

### NOTE

If engine does not start after 5 pulls, use Cold Start Procedure.

1. *Stop Switch*  
Move Stop Switch (A) to START position.
2. *Primer*  
Pump primer bulb (C) until fuel is visible and flows freely in the clear fuel tank return line. Pump bulb an additional 4 or 5 times.
3. *Choke*  
Be certain choke (B) is open.
4. *Recoil Starter*  
Pull recoil starter rope.
5. *Start*  
Start engine at idle.

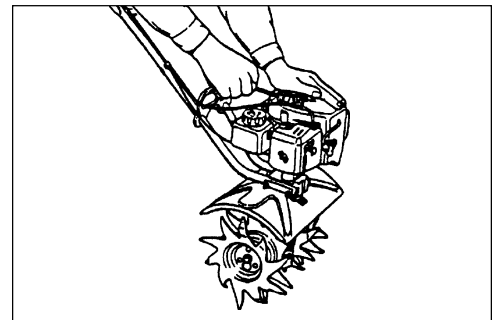
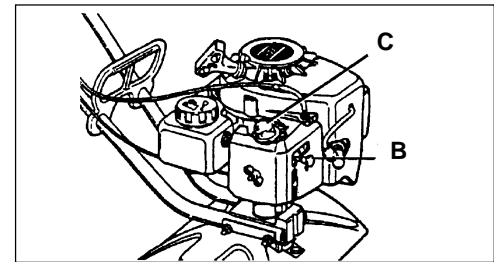

## STOPPING ENGINE

1. *Throttle Trigger*  
Release throttle and allow engine to return to idle before shutting engine off.
2. *Stop Switch*  
Move stop switch to STOP position (A).

## WARNING DANGER

If engine does not stop when stop switch is moved to STOP position, close choke - COLD START position - to stall engine. Have your ECHO dealer repair stop switch before using tiller/cultivator again.

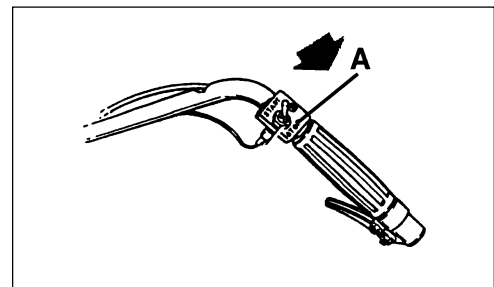

## MAINTENANCE

Your ECHO tiller/cultivator is designed to provide many hours of trouble free service. Regular scheduled maintenance will help your tiller/cultivator achieve that goal. If you are unsure or are not equipped with the necessary tools, you may want to take your unit to an ECHO Service Dealer for maintenance. To help you decide whether you want to DO-IT-YOUR-SELF or have the ECHO Dealer do it, each maintenance task has been graded. If the task is not listed, see your ECHO dealer for repairs.

### SKILL LEVEL

**Level 1**= Easy to do. Most required tools come with unit.

**Level 2**= Moderate difficulty. Some specialized tools may be required.

**Level 3**= Experience required. Specialized tools are required. ECHO recommends that the unit be returned to your ECHO Dealer for service.

ECHO offers **REPOWER™** Maintenance Kits and Parts to make your maintenance job easier. Just below each task heading are listed the various part numbers required for that task. See your ECHO dealer for these parts.

### MAINTENANCE INTERVALS

COMPONENT/ SYSTEM	MAINTENANCE PROCEDURE	REQ'D SKILL LEVEL	DAILY OR BEFORE USE	EVERY REFUEL	3 MONTHS OR 90 HOURS	6 MONTHS OR 270 HOURS	YEARLY 600 HOURS
<b>Recommended Echo Dealer Maintenance Procedures</b>							
Cylinder Exhaust Port	Inspect/Clean/Decarbon	<b>3</b>			<b>I / C</b>		
<b>Do-It-Yourself Maintenance Procedures</b>							
Air Filter	Inspect/Clean/Replace	<b>1</b>	<b>I / C</b>		<b>R*</b>		
Choke	Inspect/Clean	<b>2</b>	<b>I / C</b>				
Fuel Filter	Inspect/Replace	<b>1</b>			<b>I</b>		<b>R *</b>
Fuel System, leaks	Inspect/Replace	<b>1</b>	<b>I *</b>	<b>I*</b>			
Cooling System	Inspect/Clean	<b>2</b>	<b>I / C</b>				
Muffler Spark Arrestor	Inspect/Replace	<b>2</b>			<b>I *</b>		
Gear Housing	Grease	<b>2</b>			<b>I (1)</b>		
Tines	Inspect/Clean	<b>1</b>	<b>I / C</b>				
Recoil Starter Rope	Inspect/Clean	<b>1</b>	<b>I / C *</b>				
Spark Plug	Inspect/Clean	<b>2</b>			<b>I / C</b>	<b>R *</b>	
Screws/Nuts/Bolts	Inspect/Tighten/Replace	<b>1</b>	<b>I / R *</b>				

**MAINTENANCE PROCEDURE LETTER CODES: I = INSPECT, R = REPLACE, C = CLEAN**

**IMPORTANT NOTE** - Time intervals shown are maximum. Actual use and your experience will determine the frequency of required maintenance.

**MAINTENANCE PROCEDURE NOTES:**

(1) Apply ECHO® LUBE™ every 25 hours.

\* All recommendations to replace are based on the finding of damage or wear during inspection..

## AIR FILTER

### Level 1.

*Tools required:* 25-50mm (1-2 in.) medium bristle paint brush.

*Parts required:* 90008REPOWER™ AIR & FUEL FILTER KIT.

1. Close choke (Cold Start Position). This prevents dirt from entering the carburetor throat when the air filter is removed. Brush accumulated dirt from the air cleaner area.
2. Remove the air cleaner cover. Clean and inspect the element for damage. If element is fuel soaked and very dirty, replace.
3. If element can be cleaned and reused, be certain it:
  - still seals the cavity in the air cleaner cover.
  - is installed with the original side out.

#### NOTE

Carburetor adjustment may be needed after air filter cleaning/replacement. See Carburetor Adjustment Section.

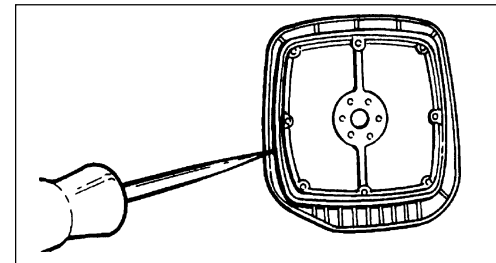
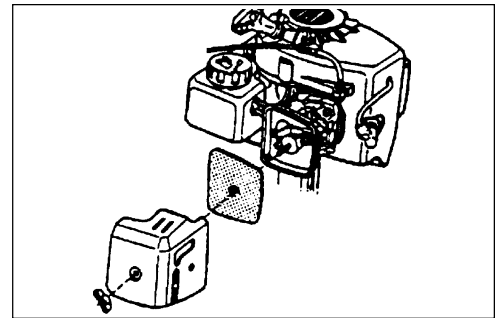
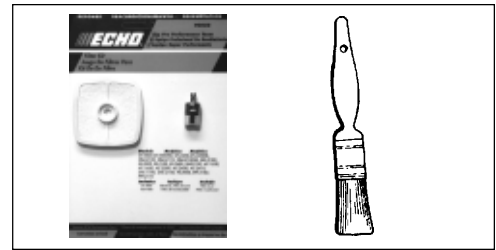

## FUEL FILTER

### Level 1.

*Tools required:* Fuel line hook. 200-250mm (8-10 in.) length of wire with one end bent into a hook. Clean rag, funnel, and an approved fuel container.

*Parts required:* 90008REPOWER™ AIR & FUEL FILTER KIT

### WARNING DANGER

Fuel is **VERY** flammable. Use extreme care when mixing, storing or handling, or serious personal injury may result.

1. Use a clean rag to remove loose dirt from around fuel cap and empty fuel tank.
2. Use the "fuel line hook" to pull the fuel line and filter (A) from the tank.
3. Remove the filter (A) from the line and install the new filter.

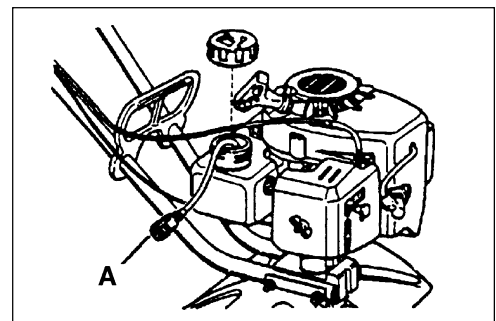

## SPARK PLUG

### Level 2.

*Tools Required:* Spark Plug socket wrench and screw driver, Feeler gauge. Preferably a wire gauge.

*Parts Required:* Spark Plug, NGK - BPMR-8Y

1. Remove spark plug and check for fouling, worn and rounded center electrode.
2. Clean the plug or replace with a new one. DO NOT sand blast to clean. Remaining sand will damage engine.
3. Adjust spark plug gap by bending outer electrode.
4. Tighten spark plug to 145-155 kg/cm (125-135 in. lb.).

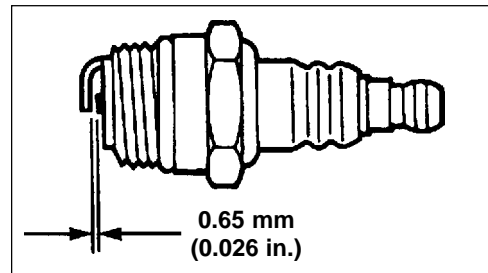
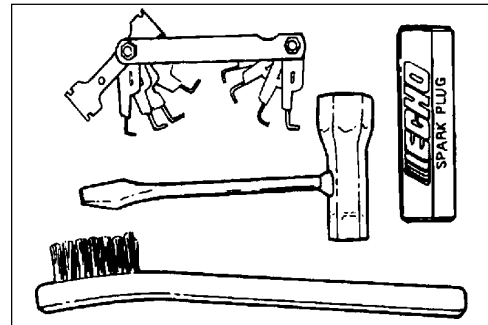

## COOLING SYSTEM CLEANING

### Level 2.

*Tools required:* Cross Head Screwdriver, 3mm Hex wrench, Pointed Wood Stick, 25-50mm (1-2 in.) medium bristle paint brush.

*Parts Required:* None.

#### IMPORTANT

To maintain proper engine operating temperatures, cooling air must pass freely through the cylinder fin area. This flow of air carries combustion heat away from the engine.

Overheating and engine seizure can occur when:

- Air intakes are blocked, preventing cooling air from reaching the cylinder.
- Dust and grass build up on the outside of the cylinder. This build up insulates the engine and prevents the heat from leaving.

Removal of cooling passage blockages or cleaning of cooling fins is considered "Normal Maintenance". Any failure attributed to lack of maintenance is not warranted.

1. Remove spark plug lead, spark plug, and throttle cable end from the carburetor swivel.
2. Remove four screws from starter cover, lift the cover from the engine and lay to the side.

#### NOTE

The throttle linkage remains assembled to the cover.

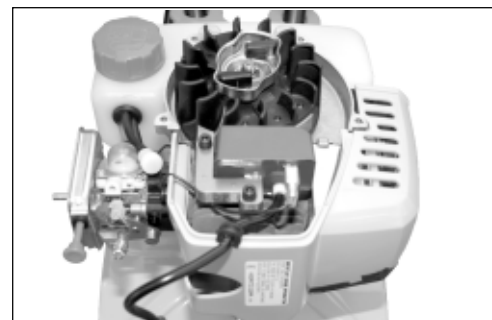
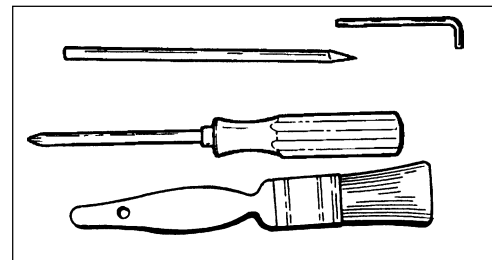



3. Remove bottom right (A) and bottom left (B) screws from cylinder cover.
4. Carefully pull cylinder cover forward disengaging muffler gasket tabs and ignition lead and lay aside.
5. Loosely install spark plug to keep debris out of the cylinder. Use brush to remove dirt from cylinder fins.

**IMPORTANT**

DO NOT use a metal scraper to remove dirt from the cylinder fins.

6. Assemble components in reverse order.

**NOTE**

When installing the cylinder cover, be certain the muffler gasket tabs are locked into the muffler grill slots and the stop switch lead is seated in the relief notch.

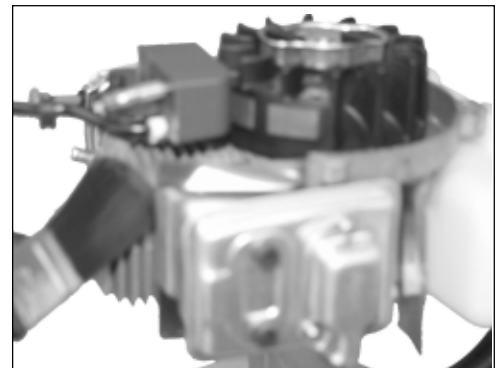
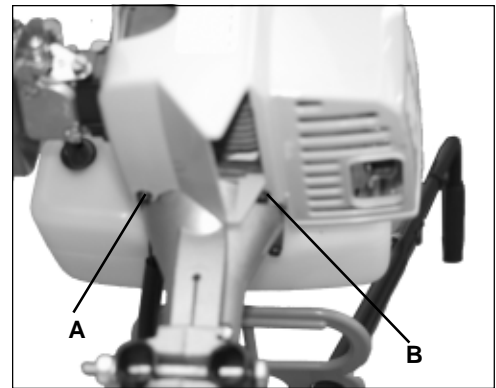

## Cylinder Exhaust Port

**Level 3.**

**IMPORTANT**

The cylinder exhaust port must be inspected and cleaned of excess carbon every 3 months or 90 hours of operation in order to maintain this engine within the emissions durability period. ECHO strongly recommends that you return your unit to your ECHO dealer for this important maintenance service.

## EXHAUST SYSTEM

### Spark Arrestor Screen

**Level 2.**

*Tools Required:* Cross Head Screwdriver. 3mm Hex wrench. Soft metal brush. Wooden carbon scraper.

*Parts Required:* Spark Arrestor Screen P/N 14586240630, Gasket P/N 14586642031

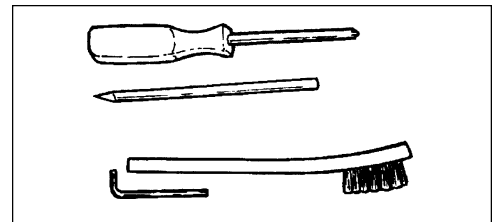

1. Remove screen cover (A), screen holder (B), and gasket (C) from muffler body.
2. Clean carbon deposits from and muffler components.
3. Replace screen if it is cracked, plugged or has holes burned through.
4. Install with new gaskets.

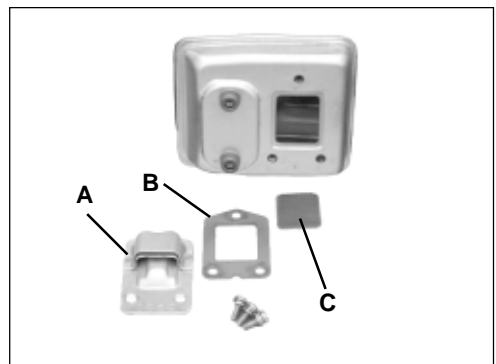

## CARBURETOR ADJUSTMENT

### Level 2.

*Tools required:* Screwdriver, Tachometer (ECHO P/N 99051130017).

*Parts required:* None.

#### NOTE

Every unit is run at the factory and the carburetor is set in compliance with emission regulations. In addition, the carburetor is equipped with HI (A) and LO (B) needle adjustment limiters that prevent settings outside acceptable limits.

1. Before adjusting the carburetor, clean or replace the air filter and spark arrester screen.
2. Start engine and run for several minutes to reach operating temperature.
3. Stop engine. Turn HI (A) speed needle CCW (counter clockwise) to stop. Turn LO (B) speed needle midway between full CCW and CW (clockwise) stops.
4. Idle Speed Adjustment.  
-Start engine and turn idle speed adjustment screw (C), CW until the tines begin to turn, then turn the screw CCW until tines stop turning. Turn screw CCW an additional 1/4 turn.
5. Accelerate to full throttle for 2-3 seconds to clear excess fuel from engine then return to idle. Accelerate to full throttle to check for smooth transition from idle to full throttle. If engine hesitates, turn LO (B) needle CCW an additional 1/8 turn and repeat acceleration. Continue adjusting until smooth acceleration results.
6. Check HI (A) speed RPM at W.O.T. (Wide Open Throttle). HI speed RPM should be set to specifications found on page 9 "Specifications" of this manual.
7. Check idle speed and reset if necessary. If a tachometer is available, idle speed should be set to the specification found on page 9 "Specifications" of this manual.

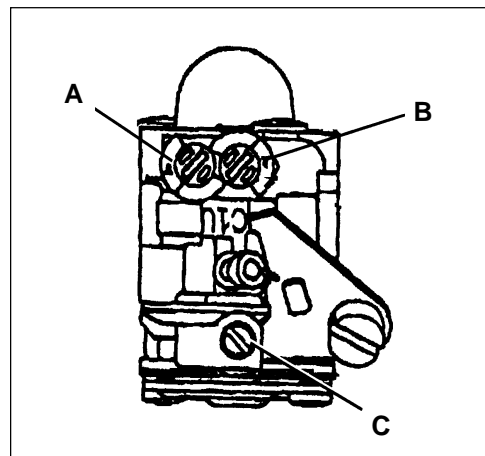
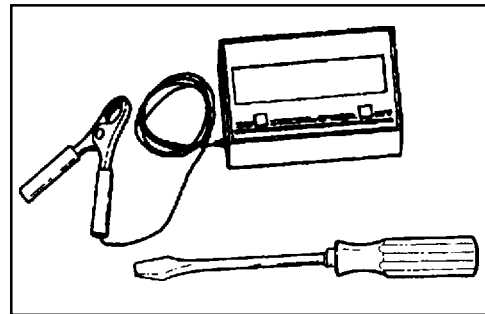

### WARNING DANGER

When carburetor adjustment is completed, tines should not move at idle, otherwise serious personal injury may result.

## LUBRICATION

### Level 1.

*Tools Required:* Crosshead Screw Driver

*Parts Required:* Lithium Base Grease.

### *Gear Housing*

1. Remove tines (See Tine Removal - Installation).
2. Clean dirt from area around gear cover (A) and remove four (4) crosshead screw (B). Be careful not to tear sealing gasket (C).
3. Support tiller with exposed gear case (D) upward. Add #0 lithium grease until nearly level with top of gear case (D).

#### **IMPORTANT**

**Do not over fill.** Too much grease will cause pressure and possible seal failure.

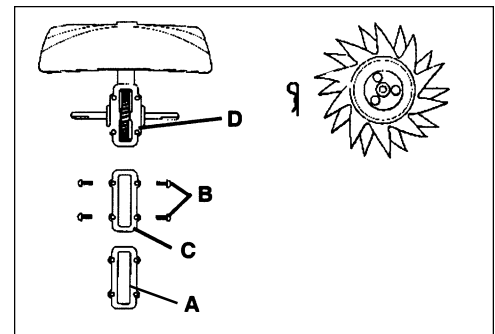
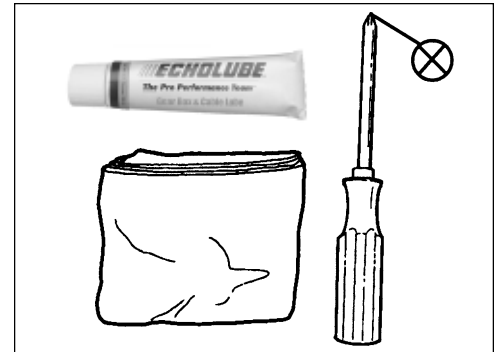

### *Cleaning Tines*

(After Each Use)

#### **NOTE**

Wear gloves to protect hands from sharp blades.

1. Remove weeds, etc. from tines and wash dirt from unit.

### *Tine Removal - Installation*

#### **WARNING** **DANGER**

Stop engine and disconnect spark plug wire before removing or installing tines. Contact with revolving tines will cause severe injury.

1. Remove retaining pin (E) and slide tine from shaft.
2. Clean accumulated dirt and debris from gear housing and tine shaft.
3. Slide tine on shaft, D-hole (hole with flat on one side) goes to the outside, install retaining pin.

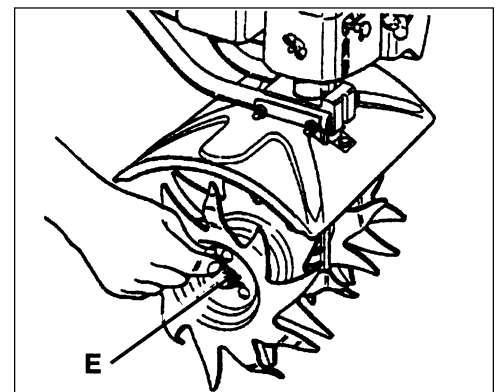

## TROUBLESHOOTING

### ENGINE PROBLEM TROUBLESHOOTING CHART

Problem	Check	Status	Cause	Remedy
Engine cranks - starts hard/ doesn't start	Fuel at carburetor	No fuel at carburetor	Fuel strainer clogged Fuel line clogged Carburetor	Clean or replace Clean or replace See your Echo dealer
	Fuel at cylinder	No fuel at cylinder	Carburetor	See your Echo dealer
		Muffler wet with fuel	Fuel Mixture too rich	Open choke Clean/replace air filter Adjust carburetor See your Echo dealer
	Spark at end of plug wire	No spark	Stop switch off Electrical problem Interlock switch	Turn switch to ON See your Echo dealer See your Echo dealer
	Spark at plug	No spark	Spark gap incorrect Covered with carbon Fouled with fuel Plug defective	Adjust to .65mm (0.026 in.) Clean or replace Clean or replace Replace plug
Engine runs, but dies or does not accelerate properly	Air filter	Air filter dirty	Normal wear	Clean or replace
	Fuel filter	Fuel filter dirty	Contaminants/residues in fuel	Replace
	Fuel vent	Fuel vent plugged	Contaminants/residues in fuel	Clean or replace
	Spark Plug	Plug dirty/worn	Normal wear	Clean and adjust or replace
	Carburetor	Improper adjustment	Vibration	Adjust
	Cooling System	Excessive dirt/debris	Extended operation in dirty/dusty locations	Clean
	Spark Arrestor Screen	Screen cracked, plugged, or perforated	Normal wear	Replace
Engine does not crank	N/A	N/A	Internal engine problem	See your Echo dealer

### WARNING DANGER

Fuel vapors are **extremely** flammable and may cause fire and/or explosion. **Never** test for ignition spark by grounding spark plug against cylinder, otherwise serious personal injury may result.

## STORAGE

### *Long Term Storage (over 30 days)*

#### WARNING DANGER

During operation the muffler or catalytic muffler and surrounding cover become hot. Always keep exhaust area clear of flammable debris during transportation or when storing, otherwise serious property damage or personal injury may result.

Do not store your unit for a prolonged period of time (30 days or longer) without performing protective storage maintenance which includes the following:

1. Store unit in a dry, dust free place, out of the reach of children.

#### WARNING DANGER

**Do not store in enclosure where fuel fumes may accumulate or reach an open flame or spark or serious personal injury may result.**

2. Place the stop switch in the "OFF" position.
3. Remove accumulation of grease, oil, dirt and debris from exterior of unit.
4. Perform all periodic lubrication and services that are required.
5. Tighten all the screws and nuts.
6. **Drain** the fuel tank **completely** and pull the recoil starter handle several times to remove fuel from the carburetor.
7. Remove the spark plug and pour 7 cc (1/4 oz.) [1/2 tablespoon] of fresh, clean, two-stroke engine oil into the cylinder through the spark plug hole.
  - A. Place a clean cloth over the spark plug hole.
  - B. Pull the recoil starter handle 2-3 times to distribute the oil inside the engine.
  - C. Observe the piston location through the spark plug hole. Pull the recoil starter handle slowly until the piston reaches the top of its travel and leave it there.
8. Install the spark plug (do not connect spark plug cable).

**NOTES**

**NOTES**

## SERVICING INFORMATION

### PARTS

Genuine ECHO Parts and ECHO REPOWER™ Parts and Assemblies for your ECHO products are available only from an Authorized ECHO Dealer. When you do need to buy parts **always** have the Model Number and Serial Number of the unit with you. You can find these numbers on the engine housing. For future reference, write them in the space provided below.

Model No. \_\_\_\_\_ SN. \_\_\_\_\_

### SERVICE

Service of this product during the warranty period must be performed by an Authorized ECHO Service Dealer. For the name and address of the Authorized ECHO Service Dealer nearest you, ask your retailer or call: 1-800-432-ECHO (3246). Dealer information is also available on our Web Site. When presenting your unit for Warranty service/repairs, proof of purchase is required.

### ECHO CONSUMER PRODUCT SUPPORT

If you require assistance or have questions concerning the application, operation or maintenance of this product you may call the ECHO Consumer Product Support Department at 1-800-673-1558 from 8:30 am to 4:30 pm (Central Standard Time) Monday through Friday. Before calling, please know the model and serial number of your unit to help your Consumer Product Support Representative.

### WARRANTY REGISTRATION

You may register your Echo equipment using the warranty registration card or register on-line at [www.echo-usa.com](http://www.echo-usa.com). Registering provides a direct link between you and ECHO if we find it necessary to contact you.

### ADDITIONAL OR REPLACEMENT MANUALS

**Safety Manuals** in English/Spanish or English/French are available, free of charge, from your ECHO dealer or at [www.echo-usa.com](http://www.echo-usa.com).

**Operator's and Parts Manuals** are available by:

- Downloading free from [www.echo-usa.com](http://www.echo-usa.com)
- Purchasing from your Echo Dealer.
- Sending a check or money order for \$2.00 per Parts Catalog or \$1.50 per Operator's Manual made payable to ECHO, INCORPORATED. State on a sheet of paper the model number and serial number of the ECHO unit you have, part number of the manual (if known), your name and address and mail to address below.

**Safety Videos** are available from your Echo dealer. A \$5.00 shipping charge will be required for each video.

#### Available Parts Catalog

TC-210 Serial Number 07001001 - 07999999

Part Number 99922203544

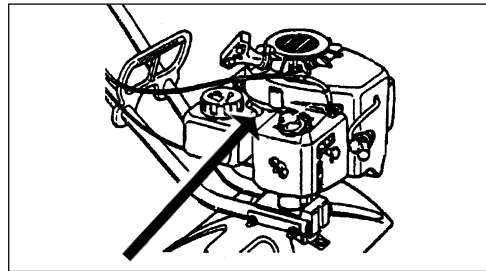

**DEALER?**  
Call  
**1-800-432-ECHO**  
or  
**[www.echo-usa.com](http://www.echo-usa.com)**

**CONSUMER PRODUCT  
SUPPORT**  
**1-800-673-1558**  
**8:30 - 4:30 Mon - Fri C.S.T.**

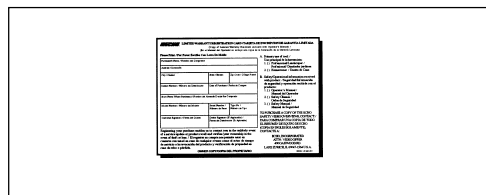

**ECHO**  
ECHO, INCORPORATED  
400 OAKWOOD ROAD  
LAKE ZURICH, IL 60047  
[www.echo-usa.com](http://www.echo-usa.com)