

KOHLER® Command PRO

EN
ESS
FRC

ECH630-ECH749, CH735/CH26, CH745

ECV630-ECV749, CV735, CV745

Owner's Manual

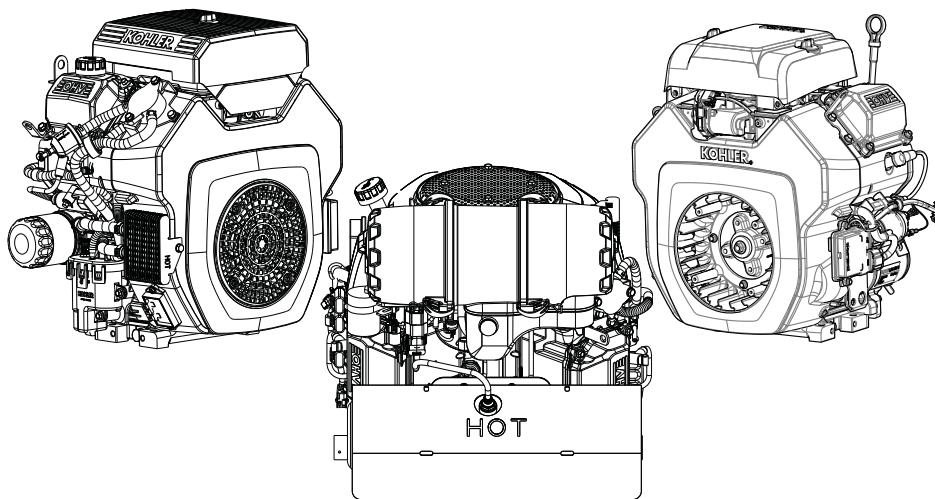

IMPORTANT:

Read all safety precautions and instructions carefully before operating equipment. Refer to operating instruction of equipment that this engine powers.

Ensure engine is stopped and level before performing any maintenance or service.

Warranty coverage as outlined in the warranty card and on KohlerEngines.com. Please review carefully as it provides your specific rights and obligations.

To maintain compliance with applicable emission regulations, exhaust system backpressure may not exceed limits which can be found on KohlerEngines.com. Search by Model No., then select Specs tab.

Kohler Engines has published CO₂ values on KohlerEngines.com website.

Record engine information to reference when ordering parts or obtaining warranty coverage.

Engine Model _____

Specification _____

Serial Number _____

Purchase Date _____

Safety Precautions

▲ WARNING: A hazard that could result in death, serious injury, or substantial property damage.

▲ CAUTION: A hazard that could result in minor personal injury or property damage.

NOTE: is used to notify people of important installation, operation, or maintenance information.

	<p>▲ WARNING</p> <p>Explosive Fuel can cause fires and severe burns.</p> <p>Do not fill fuel tank while engine is hot or running.</p>
<p>Gasoline is extremely flammable and its vapors can explode if ignited. Store gasoline only in approved containers, in well ventilated, unoccupied buildings, away from sparks or flames. Spilled fuel could ignite if it comes in contact with hot parts or sparks from ignition. Never use gasoline as a cleaning agent.</p>	

	<p>▲ WARNING</p> <p>Carbon Monoxide can cause severe nausea, fainting or death.</p> <p>Avoid inhaling exhaust fumes. Never run engine indoors or in enclosed spaces.</p>
<p>Engine exhaust gases contain poisonous carbon monoxide. Carbon monoxide is odorless, colorless, and can cause death if inhaled.</p>	

	<p>▲ WARNING</p> <p>Accidental Starts can cause severe injury or death.</p> <p>Disconnect and ground spark plug lead(s) before servicing.</p>
<p>Before working on engine or equipment, disable engine as follows: 1) Disconnect spark plug lead(s). 2) Disconnect negative (-) battery cable from battery.</p>	

	<p>▲ WARNING</p> <p>High Pressure Fluids can puncture skin and cause severe injury or death.</p> <p>Do not work on fuel system without proper training or safety equipment.</p>
<p>Fluid puncture injuries are highly toxic and hazardous. If an injury occurs, seek immediate medical attention.</p>	

	<p>▲ WARNING</p> <p>Rotating Parts can cause severe injury.</p> <p>Stay away while engine is in operation.</p>
<p>Keep hands, feet, hair, and clothing away from all moving parts to prevent injury. Never operate engine with covers, shrouds, or guards removed.</p>	

	<p>▲ WARNING</p> <p>Hot Parts can cause severe burns.</p> <p>Do not touch engine while operating or just after stopping.</p>
<p>Never operate engine with heat shields or guards removed.</p>	

	<p>▲ CAUTION</p> <p>Electrical Shock can cause injury.</p> <p>Do not touch wires while engine is running.</p>
--	--

<p>▲ WARNING: This product can expose you to chemicals including carbon monoxide and benzene, which are known to the State of California to cause cancer and birth defects or other reproductive harm. For more information go to www.P65Warnings.ca.gov.</p>
--

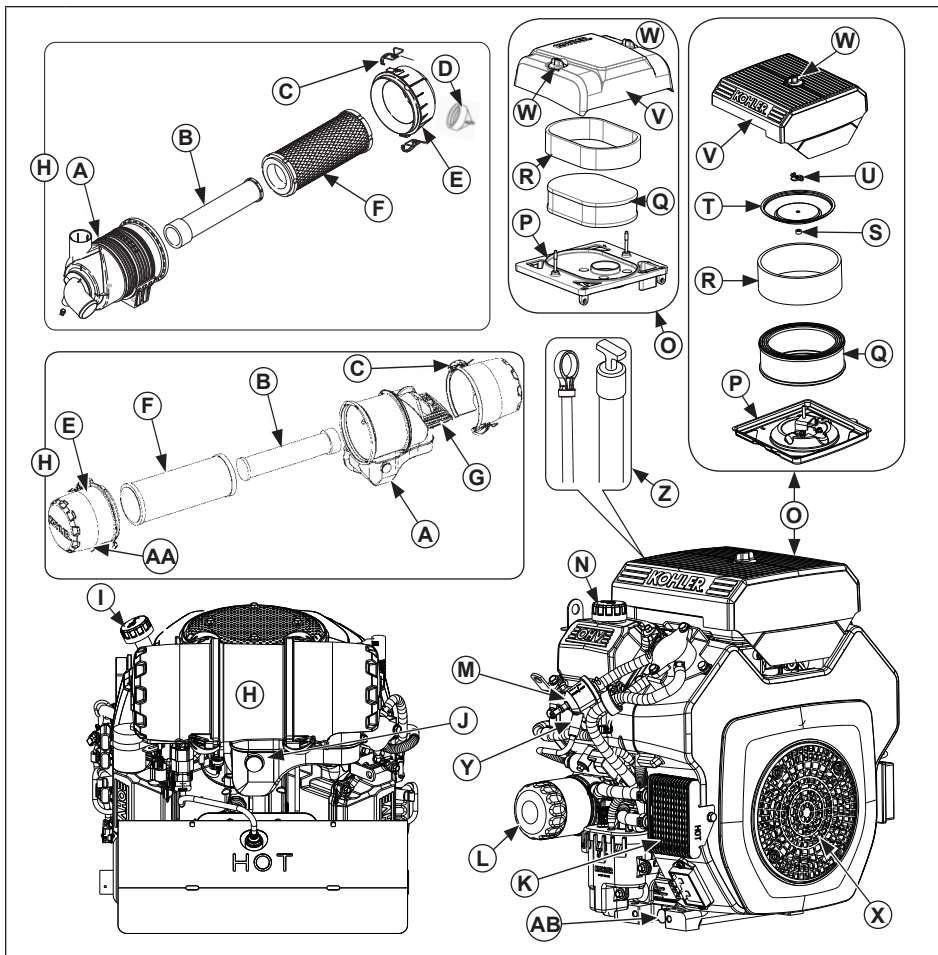

A	Air Cleaner Housing	B	Inner Element	C	Retaining Clip	D	Dust Ejector Valve
E	End Cap	F	Element	G	Inlet Screen	H	Heavy-Duty Air Cleaner
I	Oil Fill/Dipstick	J	Filter Minder	K	Oil Cooler	L	Oil Filter
M	Fuel Filter	N	Oil Fill	O	Low-Profile Air Cleaner	P	Air Cleaner Base
Q	Paper Element	R	Pre-cleaner	S	Rubber Seal	T	Element Cover
U	Wing Nut	V	Air Cleaner Cover	W	Air Cleaner Knob	X	Debris Screen
Y	Spark Plug	Z	Dipstick	AA	Ejector Area	AB	Oil Drain Plug

Visit KohlerEngines.com for service parts information and purchasing options.

Pre-Start Checklist

1. Check oil level. Add oil if low. Do not overfill.
2. Check fuel level. Add fuel if low. Check fuel system components and lines for leaks.
3. Check and clean cooling areas, air intake areas and external surfaces of engine (particularly after storage).
4. Check that air cleaner components and all shrouds, equipment covers, and guards are in place and securely fastened.
5. Check spark arrestor (if equipped).

Starting

	! WARNING
	Carbon Monoxide can cause severe nausea, fainting or death. Avoid inhaling exhaust fumes. Never run engine indoors or in enclosed spaces.
Engine exhaust gases contain poisonous carbon monoxide. Carbon monoxide is odorless, colorless, and can cause death if inhaled.	

	! WARNING
	Rotating Parts can cause severe injury. Stay away while engine is in operation.
Keep hands, feet, hair, and clothing away from all moving parts to prevent injury. Never operate engine with covers, shrouds, or guards removed.	

NOTE: To prime a dry fuel system, turn key switch to ON position for one minute. Allow fuel pump to cycle and prime system. Turn key switch OFF.

NOTE: Do not crank engine continuously for more than 10 seconds. Allow a 60 second cool down period between starting attempts. Failure to follow these guidelines can burn out starter motor.

NOTE: Upon start-up, a metallic ticking may occur. Run engine for 5 minutes. If noise continues, run engine at mid throttle for 20 minutes. If noise persists, take engine to your local Kohler authorized dealer.

1. Place throttle control midway between slow and fast positions.
2. Turn key switch to START position. Release switch as soon as engine starts. If starter does not turn engine over, shut off key switch immediately. Do not make further attempts to start engine until condition is corrected. Do not jump start. See your Kohler authorized dealer for trouble analysis.

Cold Weather Starting Hints

1. Use proper oil for temperature expected.
2. Disengage all possible external loads.
3. Use fresh winter grade fuel. Winter grade fuel has higher volatility to improve starting.

Stopping

1. If possible, remove load by disengaging all PTO driven attachments.
2. If equipped, move throttle control to slow or idle position; stop engine.
3. If equipped, close fuel shut-off valve.

Angle of Operation

Refer to operating instructions of equipment this engine powers. Do not operate this engine exceeding maximum angle of operation; see specification table. Engine damage could result from insufficient lubrication.

Engine Speed

NOTE: Do not tamper with governor setting to increase maximum engine speed. Overspeed is hazardous and will void warranty.

Maintenance Instructions

	! WARNING	Before working on engine or equipment, disable engine as follows: 1) Disconnect spark plug lead(s). 2) Disconnect negative (-) battery cable from battery.
	Accidental Starts can cause severe injury or death. Disconnect and ground spark plug lead(s) before servicing.	

Normal maintenance, replacement or repair of emission control devices and systems may be performed by any repair establishment or individual; however, warranty repairs must be performed by a Kohler authorized dealer found at KohlerEngines.com or 1-800-544-2444 (U.S. and Canada).

Maintenance Schedule

Every 25 Hours or Annually¹

- Service/replace low-profile precleaner (if equipped).

Every 100 Hours or Annually¹

- Change oil.
- Replace low-profile air cleaner element.
- Remove and clean shrouds and cooling areas. Inspect for any debris visible through flywheel cooling holes (if equipped) and clean as necessary.
- Check oil cooler fins, clean as necessary (if equipped).

Every 150 Hours

- Check heavy-duty filter minder.
- Inspect heavy-duty air filter paper element and inlet screen area.

Every 200 Hours¹

- Replace unique Electronic Fuel Injection (EFI) fuel filter.

Every 200 Hours

- Change oil filter.

Every 300 Hours¹

- Replace heavy-duty air cleaner element and check inner element.

Every 300 Hours²

- Change oil and filter (KOHLER PRO 10W-50 oil and KOHLER PRO filter only).

Every 500 Hours or Annually¹

- Replace spark plugs and set gap.

Every 600 Hours¹

- Replace heavy-duty air cleaner inner element.

¹ Perform these procedures more frequently under severe, dusty, dirty conditions.

² Option only if using KOHLER[®] PRO oil and PRO filter.

Oil Recommendations

All-season KOHLER[®] PRO 10W-50 Synthetic Oil is the ideal oil for KOHLER engines. It is specifically formulated to extend the oil and oil filter change interval to 300 Hours when paired with a KOHLER PRO Extended Life Oil Filter.

300-Hour oil and oil filter change intervals are exclusive to and only authorized on KOHLER engines that utilize both the KOHLER PRO 10W-50 Synthetic Oil and KOHLER PRO Extended Life Oil Filter. Alternative engine oils and oil filters may be used with KOHLER engines but require 100-Hour oil and 200-Hour oil filter change intervals for proper maintenance. Oil must be API (American Petroleum Institute) service class SJ or higher. Select viscosity based on air temperature at time of operation as shown below.

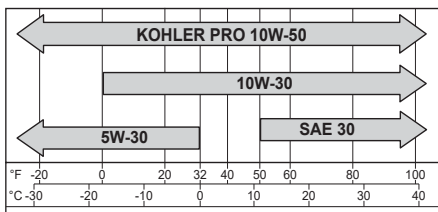

Check Oil Level

NOTE: To prevent extensive engine wear or damage, never run engine with oil level below or above operating range indicator on dipstick.

Ensure engine is cool. Clean oil fill/dipstick areas of any debris.

1. Remove dipstick; wipe oil off.
 - a. Push-on cap: reinsert dipstick into tube; press completely down.
or
 - b. Threaded cap: reinsert dipstick into tube; rest cap on tube, do not thread cap onto tube.
2. Remove dipstick; check oil level. Level should be at top of indicator on dipstick.
3. If oil is low on indicator, add oil up to top of indicator mark.
4. Reinstall and secure dipstick.

Change Oil and Filter

Change oil while engine is warm.

1. Clean area around oil fill cap/dipstick and drain plug. Remove drain plug and oil fill cap/dipstick. Allow oil to drain completely.

- Clean area around oil filter. Place a container under filter to catch any oil and remove filter. Wipe off mounting surface. Reinstall drain plug. Torque to 10 ft. lb. (13.6 N·m).
- Place new filter in shallow pan with open end up. Fill with new oil until oil reaches bottom of threads. Allow 2 minutes for oil to be absorbed by filter material.
- Apply a thin film of clean oil to rubber gasket on new filter.
- Refer to instructions on oil filter for proper installation.
- Fill crankcase with new oil. Level should be at top of indicator on dipstick.
- Reinstall oil fill cap/dipstick and tighten securely.
- Start engine; check for oil leaks. Stop engine; correct leaks. Recheck oil level.
- Dispose of used oil and filter in accordance with local ordinances.

Oil Sentry™ (if equipped)

This switch is designed to prevent engine from starting in a low oil or no oil condition. Oil Sentry™ may not shut down a running engine before damage occurs. In some applications this switch may activate a warning signal. Read your equipment manuals for more information.

Fuel Recommendations

	<p>⚠ WARNING</p> <p>Explosive Fuel can cause fires and severe burns.</p> <p>Do not fill fuel tank while engine is hot or running.</p>
<p>Gasoline is extremely flammable and its vapors can explode if ignited. Store gasoline only in approved containers, in well ventilated, unoccupied buildings, away from sparks or flames. Spilled fuel could ignite if it comes in contact with hot parts or sparks from ignition. Never use gasoline as a cleaning agent.</p>	

NOTE: E15, E20 and E85 are NOT approved and should NOT be used; effects of old, stale or contaminated fuel are not warrantable.

Fuel must meet these requirements:

- Clean, fresh, unleaded gasoline.
- Octane rating of 87 (R+M)/2 or higher.
- Research Octane Number (RON) 90 octane minimum.
- Gasoline up to 10% ethyl alcohol, 90% unleaded is acceptable.
- Methyl Tertiary Butyl Ether (MTBE) and unleaded gasoline blend (max 15% MTBE by volume) are approved.

- Do not add oil to gasoline.
- Do not overfill fuel tank.
- Do not use gasoline older than 30 days.

Fuel Line

High pressure fuel line meeting SAE R12 standard must be installed on Kohler Co. engines equipped with an EFI system.

Spark Plugs

	<p>⚠ CAUTION</p> <p>Electrical Shock can cause injury.</p> <p>Do not touch wires while engine is running.</p>
---	--

Clean out spark plug recess. Remove plug and replace.

- Check gap using wire feeler gauge. Adjust gap, see specification table for adjustment.
- Reinstall plug into cylinder head.
- Torque plug to 20 ft. lb. (27 N·m).

Jump Starting

Follow all safety guidelines and procedures provided by battery manufacturer and/or original equipment manufacturer (OEM). Failure to follow proper procedures may result in serious personal injury and/or non-warrantable damage to engine's EFI components.

Electronic Fuel Injection (EFI) System

EFI is an electronically-controlled fuel management system which is monitored by an Electronic Control Unit (ECU). A Malfunction Indicator Light (MIL) will illuminate if problems or faults are detected. Servicing by a Kohler authorized dealer is necessary.

Fuel System Components

High pressure components inside fuel pump module are not serviceable. Engines are equipped with a special EFI fuel filter. See Maintenance Schedule.

Fuse Replacement

These engines have three (3) blade type automotive fuses. Engines equipped with a high output charging system, will have one (1) 60-amp large blade type automotive fuse, in addition to the three (3) blade type automotive fuses. However, the 30-amp fuse is then nonfunctional, as the 30-amp charging circuit has been disabled.

Replacement fuses must have same rating as blown fuse. Use fuse chart below to determine correct fuse.

Wire Color	Fuse Rating
2 Solid Red Wires	10-amp Fuse
1 Red Wire with Black Stripe 1 Red Wire with White Stripe	10-amp Fuse
2 Purple Wires	30-amp Fuse
High Output Charging System adds	
In separate wiring harness	Kohler 60-amp Fuse

Air Cleaner

NOTE: Operating engine with loose or damaged air cleaner components could cause premature wear and failure. Replace all bent or damaged components.

NOTE: Paper element cannot be blown out with compressed air.

Low-Profile

Loosen knob(s) and remove air cleaner cover. Precleaner:

1. Remove precleaner from paper element.
2. Replace or wash precleaner in warm water with detergent. Rinse and allow to air dry.
3. Saturate precleaner with new engine oil; squeeze out excess oil.
4. Reinstall precleaner over paper element.

Paper Element:

1. Clean area around element. If equipped, remove wing nut and element cover. Remove paper element with precleaner.
2. Separate precleaner from element; service precleaner and replace paper element.
3. If equipped, check condition of rubber seal and replace if necessary.
4. Install new paper element on base; install precleaner over paper element. If equipped, reinstall element cover and secure with wing nut.

Reinstall air cleaner cover and secure with knob(s).

Heavy-Duty

1. Unhook retaining clips and remove end cap(s).
2. Check and clean inlet screen (if equipped).
3. Pull air cleaner element out of housing and replace. Check condition of inner element; replace when dirty.
4. Check all parts for wear, cracks, or damage, and that ejector area is clean.

5. Install new element(s).

6. Reinstall end cap(s) with dust ejector valve/screen down; secure with retaining clips.



Breather Tube

Ensure both ends of breather tube are properly connected.

Oil Cooler (if equipped)

1. Clean fins with a brush or compressed air.
2. Remove two screws securing oil cooler, and tilt to clean back side.
3. Reinstall oil cooler.

Air Cooling

	 WARNING
	<p>Hot Parts can cause severe burns.</p> <p>Do not touch engine while operating or just after stopping.</p>
<p>Never operate engine with heat shields or guards removed.</p>	

Proper cooling is essential. To prevent over heating, clean screens, cooling fins, and other external surfaces of engine. Inspect for any debris visible through flywheel cooling holes (if equipped) and clean as necessary. Avoid spraying water at wiring harness or any electrical components. See Maintenance Schedule.

Repairs/Service Parts

We recommend that you use a Kohler authorized dealer for all maintenance, service, and replacement parts for engine. To find a Kohler authorized dealer visit KohlerEngines.com or call 1-800-544-2444 (U.S. and Canada).

Storage

If engine will be out of service for 2 months or more follow procedure below.

1. Add KOHLER PRO Series fuel treatment or equivalent to fuel tank. Run engine 2-3 minutes to get stabilized fuel into fuel system (failures due to untreated fuel are not warrantable).
2. Change oil while engine is still warm from operation (NOT required if using KOHLER PRO 10W-50 full-synthetic oil). Remove spark plug(s) and pour about 1 oz. of engine oil into cylinder(s). Replace spark plug(s) and crank engine slowly to distribute oil.
3. Disconnect negative (-) battery cable.
4. Store engine in a clean, dry place.

Troubleshooting

Do not attempt to service or replace major engine components, or any items that require special timing or adjustment procedures. This work should be performed by a Kohler authorized dealer.

Problem	Possible Cause								
	No Fuel	Improper Fuel	Dirt In Fuel Line	Broken Fusible Link	Dirty Debris Screen	Incorrect Oil Level	Engine Overload	Dirty Air Cleaner	Faulty Spark Plug
Will Not Start	•	•	•	•		•	•	•	•
Hard Starting	•	•	•			•	•	•	•
Stops Suddenly	•		•		•	•	•	•	
Lacks Power		•	•		•	•	•	•	•
Operates Erratically		•	•		•		•	•	•
Knocks or Pings		•			•		•		•
Skips or Misfires		•	•		•			•	•
Backfires			•				•	•	•
Overheats			•		•	•	•	•	
High Fuel Consumption							•	•	•

Engine Specifications

Model	Bore	Stroke	Displacement	Oil Capacity (Refill)	Spark Plug Gap	Maximum Angle of Operation (@ full oil level)*
ECH630	3.2 in. (80 mm)		42.4 cu. in. (694 cc)			25°
ECV630						
ECH650						
ECV650						
ECH730	3.27 in. (83 mm)	2.72 in. (69 mm)	45.6 cu. in. (747 cc)	1.7-2.0 U.S. qt. (1.6-1.9 L)	0.030 in. (0.76 mm)	25°
ECV730						
ECH740						
ECV740						
ECH749						
ECV749						
CH735/CH26	2.6 in. (67 mm)		44.2 cu. in. (725 cc)			25°
CV735						
CH745						
CV745						

*Exceeding maximum angle of operation may cause engine damage from insufficient lubrication.

Additional specification information can be found in service manual at KohlerEngines.com.

Any and all horsepower (hp) references by Kohler are Certified Power Ratings and per SAE J1940 & J1995 hp standards. Details on Certified Power Ratings can be found at KohlerEngines.com.

Emission Control System

Exhaust Emission Control System for models ECH630-ECH749, ECV630-ECV749, CH735/CH26, CH745, CV735, and CV745 is EM, O2S, ECM, MPI for U.S. EPA, California, and Europe.

NOTE: Tampering with the engine and its emission control system voids the EPA Certificate of Conformity, ARB Executive Order, and EU type-approval.