

KOHLER® Command PRO

CH640, CH730, CH740

Liquefied Petroleum Gas (LPG) or LPG/Natural Gas (NG) Fueled

Owner's Manual

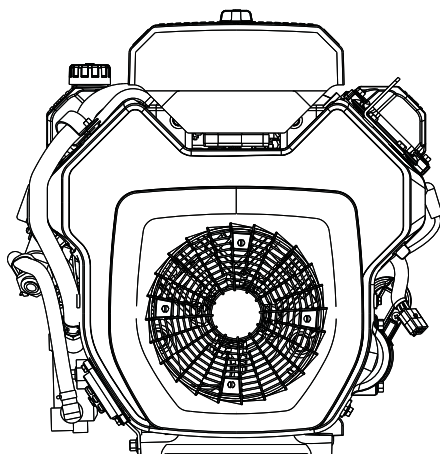

IMPORTANT:

Read all safety precautions and instructions carefully before operating equipment. Refer to operating instruction of equipment that this engine powers.

Ensure engine is stopped and level before performing any maintenance or service.

Warranty coverage as outlined in the warranty card and on KohlerEngines.com. Please review carefully as it provides your specific rights and obligations.

To maintain compliance with applicable emission regulations, exhaust system backpressure may not exceed limits which can be found on KohlerEngines.com. Search by Model No., then select Specs tab.

Kohler Engines has published CO₂ values on KohlerEngines.com website.

Record engine information to reference when ordering parts or obtaining warranty coverage.

Engine Model _____

Specification _____

Serial Number _____

Purchase Date _____

Safety Precautions

▲ WARNING: A hazard that could result in death, serious injury, or substantial property damage.

▲ CAUTION: A hazard that could result in minor personal injury or property damage.



NOTE: is used to notify people of important installation, operation, or maintenance information.

	<p>▲ WARNING</p> <p>Explosive Fuel can cause fires and severe burns.</p> <p>If a gaseous odor is detected, ventilate area and contact an authorized service technician.</p>
<p>LPG is extremely flammable and is heavier than air and tends to settle in low areas where a spark or flame could ignite gas. Do not start or operate this engine in a poorly ventilated area where leaking gas could accumulate and endanger safety of persons in area.</p> <p>NG is extremely flammable, is lighter than air, and rises. Do not start or operate this engine in a poorly ventilated area where leaking gas could accumulate and endanger safety of persons in area.</p> <p>To ensure personal safety, installation and repair of LPG/NG fuel supply systems must be performed only by qualified LPG/NG system technicians. Improperly installed and maintained LPG/NG equipment could cause fuel supply system or other components to malfunction, causing gas leaks.</p> <p>Observe federal, state and local laws governing LPG/NG fuel, storage, and systems.</p>	

	<p>▲ WARNING</p> <p>Carbon Monoxide can cause severe nausea, fainting or death.</p> <p>Avoid inhaling exhaust fumes. Never run engine indoors or in enclosed spaces.</p>
<p>Engine exhaust gases contain poisonous carbon monoxide. Carbon monoxide is odorless, colorless, and can cause death if inhaled.</p>	

	<p>▲ WARNING</p> <p>Hot Parts can cause severe burns.</p> <p>Do not touch engine while operating or just after stopping.</p>
<p>Never operate engine with heat shields or guards removed.</p>	

	<p>▲ CAUTION</p> <p>Electrical Shock can cause injury.</p> <p>Do not touch wires while engine is running.</p>
-------------------------------------------------------------------------------------	----------------------------------------------------------------------------------------------------------------------

  	<p>▲ WARNING</p> <p>Accidental Starts can cause severe injury or death.</p> <p>Disconnect and ground spark plug lead(s) before servicing.</p>
<p>Before working on engine or equipment, disable engine as follows: 1) Disconnect spark plug lead(s). 2) Disconnect negative (-) battery cable from battery.</p> <p>Before disconnecting negative (-) ground cable, make sure all switches are OFF. If ON, a spark will occur at ground cable terminal which could cause an explosion if hydrogen gas or LPG/NG fuel vapors are present.</p>	

	<p>▲ WARNING</p> <p>Rotating Parts can cause severe injury.</p> <p>Stay away while engine is in operation.</p>
<p>Keep hands, feet, hair, and clothing away from all moving parts to prevent injury. Never operate engine with covers, shrouds, or guards removed.</p>	

<p>▲ WARNING: This product can expose you to chemicals including carbon monoxide and benzene, which are known to the State of California to cause cancer and birth defects or other reproductive harm. For more information go to www.P65Warnings.ca.gov.</p>

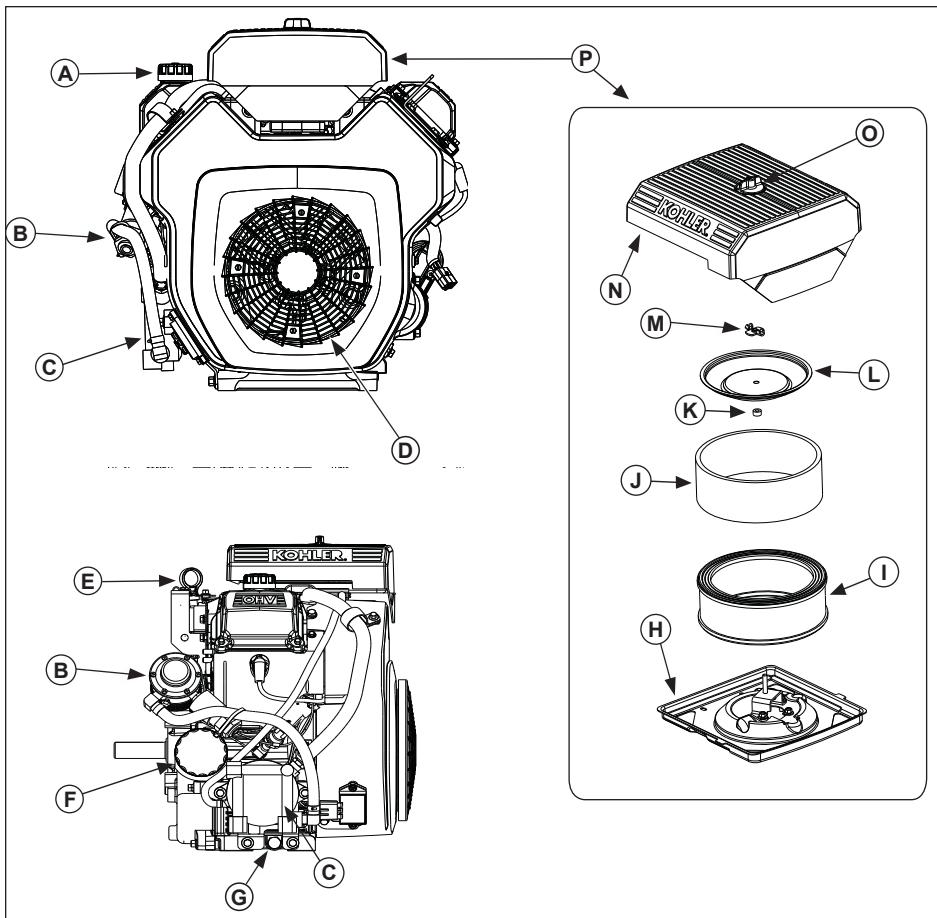

A	Oil Fill	B	Vaporizer	C	LPG Regulator	D	Debris Screen
E	Dipstick	F	Oil Filter	G	Oil Drain Plug	H	Air Cleaner Base
I	Paper Element	J	Precleaner	K	Rubber Seal	L	Element Cover
M	Wing Nut	N	Air Cleaner Cover	O	Air Cleaner Knob	P	Low-Profile Air Cleaner

Visit KohlerEngines.com for service parts information and purchasing options.

Pre-Start Checklist

1. Check oil level. Add oil if low. Do not overfill.
2. Check fuel gauge (if equipped). If LPG tank is low, have it refilled. Check fuel system components and lines for leaks.
3. Check and clean cooling areas, air intake areas and external surfaces of engine (particularly after storage).
4. Check that air cleaner components and all shrouds, equipment covers, and guards are in place and securely fastened.
5. Check spark arrestor (if equipped).

Starting



WARNING

Carbon Monoxide can cause severe nausea, fainting or death.

Avoid inhaling exhaust fumes. Never run engine indoors or in enclosed spaces.

Engine exhaust gases contain poisonous carbon monoxide. Carbon monoxide is odorless, colorless, and can cause death if inhaled.



WARNING

Rotating Parts can cause severe injury.

Stay away while engine is in operation.

Keep hands, feet, hair, and clothing away from all moving parts to prevent injury. Never operate engine with covers, shrouds, or guards removed.

NOTE: Do not crank engine continuously for more than 10 seconds. Allow a 60 second cool down period between starting attempts. Failure to follow these guidelines can burn out starter motor.

NOTE: Upon start-up, a metallic ticking may occur. Run engine for 5 minutes. If noise continues, run engine at mid throttle for 20 minutes. If noise persists, take engine to your local Kohler authorized dealer.

NOTE: If starter is engaged while flywheel is rotating, starter pinion and flywheel ring gear may clash resulting in damage to starter.

1. Place throttle control (if equipped) into idle position. Place choke control (if equipped) into ON position.
2. Slowly turn fuel valve on LPG (propane) tank or NG line (if equipped) to full open position.
3. Turn key switch to START position. Release switch as soon as engine starts. If starter does not turn engine over, shut off key switch immediately. Do not make further attempts to start engine until condition is corrected. Do not jump start. See your Kohler authorized dealer for trouble analysis.

Cold Weather Starting Hints

1. Use proper oil for temperature expected.
2. Disengage all possible external loads.

Stopping

1. If possible, remove load by disengaging all PTO driven attachments.
2. Turn fuel valve to full closed position and allow engine to continue running until it runs out of fuel. Turn key switch to OFF position. Switching off key switch prior to allowing engine to run out of fuel may create a backfire.



Angle of Operation

Refer to operating instructions of equipment this engine powers. Do not operate this engine exceeding maximum angle of operation; see specification table. Engine damage could result from insufficient lubrication.

Engine Speed

NOTE: Do not tamper with governor setting to increase maximum engine speed. Overspeed is hazardous and will void warranty.

Maintenance Instructions

	 WARNING	<p>Before working on engine or equipment, disable engine as follows: 1) Disconnect spark plug lead(s). 2) Disconnect negative (-) battery cable from battery.</p>
	<p>Accidental Starts can cause severe injury or death.</p> <p>Disconnect and ground spark plug lead(s) before servicing.</p>	

Normal maintenance, replacement or repair of emission control devices and systems may be performed by any repair establishment or individual; however, warranty repairs must be performed by a Kohler authorized dealer found at KohlerEngines.com or 1-800-544-2444 (U.S. and Canada).

For safety and health reasons, many states require special licensing or certification for servicing LPG fuel systems. Check local and state regulations before choosing a repair establishment to perform fuel system repairs.

Maintenance Schedule

Every 25 Hours¹

- Service precleaner element.

Every 100 Hours¹

- Check oil cooler fins, clean as necessary (if equipped).
- Change oil.
- Replace air cleaner element.
- Remove cooling shrouds and clean cooling areas.

Every 200 Hours¹

- Change oil filter.

Every 300 Hours³

- Change oil and filter (KOHLER PRO 10W-50 oil and KOHLER PRO filter only).

Every 500 Hours or Annually¹ (whichever comes first)

- Check all lines (high pressure/vacuum) including fittings for leaks.
- Drain regulator of accumulated fuel deposits.
- Replace spark plugs and set gap.

Every 500 Hours or Annually^{1,2} (whichever comes first)

- Have lock-off/filter serviced.

Every 1500 Hours^{1,2}

- Have regulator disassembled, cleaned, and reset.
- Have vaporizer disassembled, cleaned, and serviced.

¹ Perform these procedures more frequently under severe, dusty, dirty conditions.

² Must be performed by a Kohler authorized dealer or qualified LPG personnel only.

³ Option only if using KOHLER[®] PRO oil and PRO filter.

Oil Recommendations

All-season KOHLER[®] PRO 10W-50 Synthetic Oil is the ideal oil for KOHLER engines. It is specifically formulated to extend the oil and oil filter change interval to 300 Hours when paired with a KOHLER PRO Extended Life Oil Filter.

300-Hour oil and oil filter change intervals are exclusive to and only authorized on KOHLER engines that utilize both the KOHLER PRO 10W-50 Synthetic Oil and KOHLER PRO Extended Life Oil Filter. Alternative engine oils and oil filters may be used with KOHLER engines but require 100-Hour oil and 200-Hour oil filter change intervals for proper maintenance. Oil must be API (American Petroleum Institute) service class SJ or higher. Select viscosity based on air temperature at time of operation as shown below.

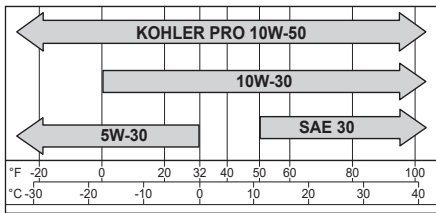

Check Oil Level

NOTE: To prevent extensive engine wear or damage, never run engine with oil level below or above operating range indicator on dipstick.

Ensure engine is cool. Clean oil fill/dipstick areas of any debris.

1. Remove dipstick; wipe oil off.
 - a. Press-in cap: reinsert dipstick into tube; press completely down.
or
 - b. Thread-on cap: reinsert dipstick into tube; rest cap on tube, do not thread cap onto tube.
2. Remove dipstick; check oil level. Level should be at top of indicator on dipstick.
3. If oil is low on indicator, add oil up to top of indicator mark.
4. Reinstall dipstick and tighten securely.

Change Oil and Filter

Change oil while engine is warm.

1. Clean area around oil fill cap/dipstick, drain plug/oil drain valve.
 - a. Remove drain plug and oil fill cap/dipstick. Allow oil to drain completely.
or
 - b. Open oil drain valve cap; if needed, attach a length of 1/2 in. I.D. hose to direct oil into appropriate container; twist valve drain body counterclockwise and pull. Remove dipstick. Allow oil to drain completely.
2. Clean area around oil filter. Place a container under filter to catch any oil and remove filter. Wipe off mounting surface.
 - a. Reinstall drain plug. Torque to 10 ft. lb. (13.6 N·m).
or
 - b. Close oil drain valve body, remove hose (if used), and replace cap.
3. Place new filter in shallow pan with open end up. Fill with new oil until oil reaches bottom of threads. Allow 2 minutes for oil to be absorbed by filter material.
4. Apply a thin film of clean oil to rubber gasket on new filter.
5. Refer to instructions on oil filter for proper installation.
6. Fill crankcase with new oil. Level should be at top of indicator on dipstick.
7. Reinstall oil fill cap/dipstick and tighten securely.
8. Start engine; check for oil leaks. Stop engine; correct leaks. Recheck oil level.
9. Dispose of used oil and filter in accordance with local ordinances.

Oil Sentry™ (if equipped)

This switch is designed to prevent engine from starting in a low oil or no oil condition. Oil Sentry™ may not shut down a running engine before damage occurs. In some applications this switch may activate a warning signal. Read your equipment manuals for more information.

Fuel Recommendations

	WARNING
	<p>Explosive Fuel can cause fires and severe burns.</p> <p>If a gaseous odor is detected, ventilate area and contact an authorized service technician.</p>

LPG is extremely flammable and is heavier than air and tends to settle in low areas where a spark or flame could ignite gas. Do not start or operate this engine in a poorly ventilated area where leaking gas could accumulate and endanger safety of persons in area.

NG is extremely flammable, is lighter than air, and rises. Do not start or operate this engine in a poorly ventilated area where leaking gas could accumulate and endanger safety of persons in area.

To ensure personal safety, installation and repair of LPG/NG fuel supply systems must be performed only by qualified LPG/NG system technicians. Improperly installed and maintained LPG/NG equipment could cause fuel supply system or other components to malfunction, causing gas leaks.

Observe federal, state and local laws governing LPG/NG fuel, storage, and systems.

This engine is certified to operate on LPG or LPG/NG.

LPG Engines

LPG from an appropriate LPG fuel tank (supplied separately) is required to operate this engine.

NG Engines

NG from an approved system or source of supply can be used to operate this engine.

Fuel Conversion

NOTE: When switching from NG to LPG fuel or LPG to NG fuel, battery must be temporarily disconnected for safety and to reset system.

Some engines are equipped to convert between LPG and NG. Models with fitting and jet should follow these instructions for conversion. Other metering valves should be installed following instructions given by equipment it powers. Shut off fuel supply before any servicing is performed.

LPG Operation

Installation of jet in regulator fitting is required for LPG operation.

Switching from NG to LPG

Remove fuel inlet hose. Inspect internal threads of regulator fitting to ensure they are clean and dry. Install jet into fuel elbow orifice for LPG operation. Reconnect and fully tighten fuel inlet hose.

Outlet pressure should be checked and if required, set at secondary regulator to 4.0 to 5.0 psi by qualified personnel.

NG Operation

Removal of jet from regulator fitting is required for NG operation.

Switching from LPG to NG

Remove LPG fuel jet from regulator fitting. Disconnect hose, remove jet from orifice, and reconnect hose.

Recommended fuel inlet pressure for NG systems is 11 in. water (engine off). Reduced pressure could result in hard starting.

LPG Regulator

In compliance with government emission standards, regulator is preset at factory to provide proper supply of fuel. No adjustment or resetting of regulator is to be made. All service relating to regulator must be performed by a Kohler authorized dealer or qualified LPG personnel only.

Over time, fuel deposits can accumulate inside regulator. Removing these deposits is recommended (Nikki regulators only). Follow steps below to drain Nikki Regulators.

1. Turn fuel supply valve off, run engine out of fuel, and turn off ignition switch.
2. Disconnect and ground spark plug leads.
3. Remove 1/8" pipe plug from bottom of regulator. Remove any accumulated deposits.
4. Reinstall plug using Teflon® pipe sealant (not Teflon® tape) on threads and tighten securely. If required, a replacement plug can be found at KohlerEngines.com.



Lock-Off/Filter Assembly

Lock-Off/Filter Assembly opens, closes, and filters liquid fuel flow from supply tank before reaching vaporizer.

Vaporizer

Vaporizer changes Liquefied Petroleum (LPG) from supply tank to a gaseous/vapor state.

Spark Plugs

	 CAUTION
	Electrical Shock can cause injury. Do not touch wires while engine is running.

Clean out spark plug recess. Remove plug and replace.

1. Check gap using wire feeler gauge. Adjust gap, see specification table for adjustment.
2. Install plug into cylinder head.
3. Torque plug to 20 ft. lb. (27 N·m).

Air Cleaner

NOTE: Operating engine with loose or damaged air cleaner components could cause premature wear and failure. Replace all bent or damaged components.

NOTE: Paper element cannot be blown out with compressed air.

Loosen knob and remove air cleaner cover.

Precleaner:

1. Remove precleaner from paper element.
2. Replace or wash precleaner in warm water with detergent. Rinse and allow to air dry.
3. Saturate precleaner with new engine oil; squeeze out excess oil.
4. Reinstall precleaner over paper element.

Paper Element:

1. Clean area around element. Remove wing nut, element cover, and paper element with precleaner.
2. Separate precleaner from element; service precleaner and replace paper element.
3. Check condition of rubber seal and replace if necessary.
4. Install new paper element on base; install precleaner over paper element; reinstall element cover and secure with wing nut.

Reinstall air cleaner cover and secure with knob.

Breather Tube (if equipped)

Ensure end of breather tube is properly connected.

Oil Cooler (if equipped)

1. Clean fins with a brush or compressed air.
2. Remove two screws securing oil cooler, and tilt to clean back side.
3. Reinstall oil cooler.

Air Cooling

	WARNING
	Hot Parts can cause severe burns. Do not touch engine while operating or just after stopping.
Never operate engine with heat shields or guards removed.	

Proper cooling is essential. To prevent over heating, clean screens, cooling fins, and other external surfaces of engine. Avoid spraying water at wiring harness or any electrical components. See Maintenance Schedule.

Repairs/Service Parts

We recommend that you use a Kohler authorized dealer for all maintenance, service, and replacement parts for engine. To find a Kohler authorized dealer visit KohlerEngines.com or call 1-800-544-2444 (U.S. and Canada).

Leakage Check/Testing

With fuel valve fully opened, engine not running, turn key switch ON. Check all fuel system connections and lines for leaks using soapy water. Any leakage must be corrected before restarting engine. Have service performed by a Kohler authorized dealer or qualified LPG/NG personnel only.

Storage

If engine will be out of service for 2 months or more follow procedure below.

1. Change oil while engine is still warm from operation (NOT required if using KOHLER PRO 10W-50 full-synthetic oil). Remove spark plug(s) and pour about 1 oz. of engine oil into cylinder(s). Replace spark plug(s) and crank engine slowly to distribute oil.
2. Disconnect negative (-) battery cable.
3. Separate LPG tank from unit and store separately in an area designated for safe LPG tank storage.
4. Store engine in a clean, dry place.

Troubleshooting

Do not attempt to service or replace major engine components, or any items that require special timing or adjustment procedures. This work should be performed by a Kohler authorized dealer.

Problem	Possible Cause									
	No Fuel	Improper Fuel	Dirt In Fuel Line	Dirty/Restricted Lock-off Fuel Filter	Dirty Debris Screen	Incorrect Oil Level	Engine Overloaded	Dirty Air Cleaner	Faulty Spark Plug	Dirty/Restricted Regulator
Will Not Start	•		•	•	•	•	•	•	•	•
Hard Starting	•	•	•	•	•	•	•	•	•	•
Stops Suddenly	•		•	•	•	•	•	•		•
Lacks Power		•	•	•	•	•	•	•	•	•
Operates Erratically		•	•	•	•	•	•	•	•	•
Knocks or Pings		•		•	•		•		•	•
Skips or Misfires		•	•	•	•			•	•	•
Backfires			•	•				•	•	•
Overheats		•	•	•	•	•	•	•		•
High Fuel Consumption								•		

Engine Specifications

Model	Bore	Stroke	Displacement	Oil Capacity (Refill)	Spark Plug Gap	Maximum Angle of Operation (@ full oil level)*
CH640	3.03 in. (77 mm)	2.64 in. (67 mm)	38 cu. in. (624 cc)	1.7-1.9 U.S. qt. (1.6-1.8 L)	0.020 in. (0.51 mm)	25°
CH730	3.27 in. (83 mm)		44 cu. in. (725 cc)		0.030 in. (0.76 mm)	
CH740						

*Exceeding maximum angle of operation may cause engine damage from insufficient lubrication.

Additional specification information can be found in service manual at KohlerEngines.com.

Any and all horsepower (hp) references by Kohler are Certified Power Ratings and per SAE J1940 & J1995 hp standards. Details on Certified Power Ratings can be found at KohlerEngines.com.

Emission Control System

Exhaust Emission Control System for gaseous fuel models CH640, CH730, and CH740 is EM for U.S. EPA, California, and Europe.

NOTE: Tampering with the engine and its emission control system voids the EPA Certificate of Conformity, ARB Executive Order, and EU type-approval.

