

KOHLER®

Command PRO EFI

PCV850, PCV860

Owner's Manual

EN

ESS

FRC

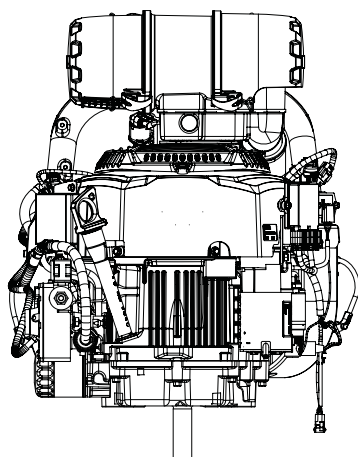

IMPORTANT:

Read all safety precautions and instructions carefully before operating equipment. Refer to operating instruction of equipment that this engine powers.

Ensure engine is stopped and level before performing any maintenance or service.

Warranty coverage as outlined in the warranty card and on KohlerEngines.com. Please review carefully as it provides your specific rights and obligations.

To maintain compliance with applicable emission regulations, exhaust system backpressure may not exceed limits which can be found on KohlerEngines.com. Search by Model No., then select Specs tab.

Kohler Engines has published CO₂ values on KohlerEngines.com website.

Record engine information to reference when ordering parts or obtaining warranty coverage.

Engine Model _____

Specification _____

Serial Number _____

Purchase Date _____

Safety Precautions

▲ WARNING: A hazard that could result in death, serious injury, or substantial property damage.

▲ CAUTION: A hazard that could result in minor personal injury or property damage.

NOTE: is used to notify people of important installation, operation, or maintenance information.

	<p>▲ WARNING</p> <p>Explosive Fuel can cause fires and severe burns.</p> <p>If a gaseous odor is detected, ventilate area and contact an authorized service technician.</p>
	<p>Propane is extremely flammable and is heavier than air and tends to settle in low areas where a spark or flame could ignite gas. Do not start or operate this engine in a poorly ventilated area where leaking gas could accumulate and endanger safety of persons in area.</p> <p>To ensure personal safety, installation and repair of propane fuel supply systems must be performed only by qualified propane system technicians. Improperly installed and maintained propane equipment could cause fuel supply system or other components to malfunction, causing gas leaks.</p> <p>Observe federal, state and local laws governing propane fuel, storage, and systems.</p>

	<p>▲ WARNING</p> <p>Carbon Monoxide can cause severe nausea, fainting or death.</p> <p>Avoid inhaling exhaust fumes. Never run engine indoors or in enclosed spaces.</p>
	<p>Engine exhaust gases contain poisonous carbon monoxide. Carbon monoxide is odorless, colorless, and can cause death if inhaled.</p>

	<p>▲ WARNING</p> <p>Rotating Parts can cause severe injury.</p> <p>Stay away while engine is in operation.</p>
	<p>Keep hands, feet, hair, and clothing away from all moving parts to prevent injury. Never operate engine with covers, shrouds, or guards removed.</p>

	<p>▲ WARNING</p> <p>High Pressure Fluids can puncture skin and cause severe injury or death.</p> <p>Do not work on fuel system without proper training or safety equipment.</p>
	<p>Fluid puncture injuries are highly toxic and hazardous. If an injury occurs, seek immediate medical attention.</p>

	<p>▲ WARNING</p> <p>Accidental Starts can cause severe injury or death.</p> <p>Disconnect and ground spark plug lead(s) before servicing.</p>
	<p>Before working on engine or equipment, disable engine as follows: 1) Disconnect spark plug lead(s). 2) Disconnect negative (-) battery cable from battery.</p> <p>Before disconnecting negative (-) ground cable, make sure all switches are OFF. If ON, a spark will occur at ground cable terminal which could cause an explosion if hydrogen gas or propane fuel vapors are present.</p>

	<p>▲ CAUTION</p> <p>Electrical Shock can cause injury.</p> <p>Do not touch wires while engine is running.</p>
	<p>Fluid puncture injuries are highly toxic and hazardous. If an injury occurs, seek immediate medical attention.</p>

	<p>▲ WARNING</p> <p>Hot Parts can cause severe burns.</p> <p>Do not touch engine while operating or just after stopping.</p>
	<p>Never operate engine with heat shields or guards removed.</p>

<p>▲ WARNING: This product can expose you to chemicals including carbon monoxide and benzene, which are known to the State of California to cause cancer and birth defects or other reproductive harm. For more information go to www.P65Warnings.ca.gov.</p>
--

	<p>▲ WARNING</p> <p>Hot Parts can cause severe burns.</p> <p>Do not touch engine while operating or just after stopping.</p>
	<p>Never operate engine with heat shields or guards removed.</p>

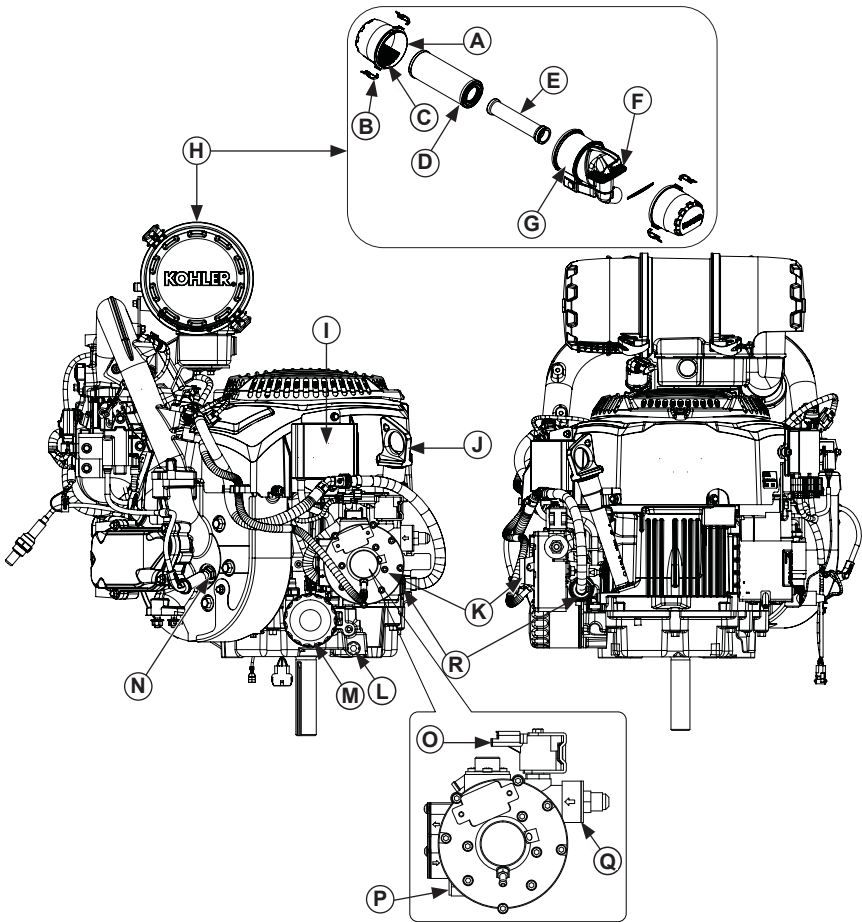



A	End Cap	B	Retaining Clip	C	Ejector Area	D	Element
E	Inner Element (if equipped)	F	Inlet Screen	G	Air Cleaner Housing	H	Heavy-Duty Air Cleaner
I	Oil Cooler (if equipped)	J	Oil Fill/Dipstick	K	Vaporizer/ Regulator	L	Oil Drain Plug
M	Oil Filter	N	Spark Plug	O	Lock-Off	P	Vaporizer/ Regulator Drain Plug
Q	Vaporizer/ Regulator Inlet Filter	R	Unique EFI Fuel Filter				



Visit KohlerEngines.com for service parts information and purchasing options.

Pre-Start Checklist

1. Check oil level. Add oil if low. Do not overfill.
2. Check fuel gauge (if equipped). If propane tank is low, have it refilled. Check fuel system components and lines for leaks.
3. Check and clean cooling areas, air intake areas and external surfaces of engine (particularly after storage).
4. Check that air cleaner components and all shrouds, equipment covers, and guards are in place and securely fastened.
5. Check spark arrestor (if equipped).

Starting

	 WARNING
	Carbon Monoxide can cause severe nausea, fainting or death. Avoid inhaling exhaust fumes. Never run engine indoors or in enclosed spaces.
Engine exhaust gases contain poisonous carbon monoxide. Carbon monoxide is odorless, colorless, and can cause death if inhaled.	

	 WARNING
	Rotating Parts can cause severe injury. Stay away while engine is in operation.
Keep hands, feet, hair, and clothing away from all moving parts to prevent injury. Never operate engine with covers, shrouds, or guards removed.	

NOTE: Do not crank engine continuously for more than 10 seconds. Allow a 60 second cool down period between starting attempts. Failure to follow these guidelines can burn out starter motor.

1. Place throttle control midway between slow and fast positions.
2. Slowly turn fuel valve on propane tank to full open position.
3. Turn key switch to START position. Release switch as soon as engine starts. If starter does not turn engine over, shut off key switch immediately. Do not make further attempts to start engine until condition is corrected. Do not jump start. See your Kohler authorized dealer for trouble analysis.

Cold Weather Starting Hints

1. Use proper oil for temperature expected.
2. Disengage all possible external loads.

Stopping

1. If possible, remove load by disengaging all PTO driven attachments.
2. Turn fuel valve to full closed position and allow engine to continue running until it runs out of fuel. Turn key switch to OFF position.



Angle of Operation

Refer to operating instructions of equipment this engine powers. Do not operate this engine exceeding maximum angle of operation; see specification table. Engine damage could result from insufficient lubrication.

Engine Speed

NOTE: Do not tamper with governor setting to increase maximum engine speed. Overspeed is hazardous and will void warranty.

Maintenance Instructions

	 WARNING	<p>Before working on engine or equipment, disable engine as follows: 1) Disconnect spark plug lead(s). 2) Disconnect negative (-) battery cable from battery.</p>
	<p>Accidental Starts can cause severe injury or death.</p> <p>Disconnect and ground spark plug lead(s) before servicing.</p>	

Normal maintenance, replacement or repair of emission control devices and systems may be performed by any repair establishment or individual; however, warranty repairs must be performed by a Kohler authorized dealer found at KohlerEngines.com or 1-800-544-2444 (U.S. and Canada).

For safety and health reasons, many states require special licensing or certification for servicing propane fuel systems. Check local and state regulations before choosing a repair establishment to perform fuel system repairs.

Maintenance Schedule

Every 100 Hours or Annually¹

- Change oil. Oil filter is recommended.
- Remove cooling shrouds and clean cooling areas.

Every 150 Hours¹

- Check air cleaner element.
- Check oil cooler fins, clean as necessary (if equipped).

Every 200 Hours¹

- Change oil filter.
- Replace unique EFI fuel filters.

Every 300 Hours¹

- Replace air cleaner element and check inner element (if equipped).

Every 500 Hours or Annually¹

- Check all lines (high pressure/vacuum) including fittings for leaks.
- Drain vaporizer/regulator of accumulated fuel deposits.
- Replace spark plugs and set gap.

Every 500 Hours or Annually^{1,2}

- Inspect lock-off assembly for damage/leakage.
- Have combustion deposits removed if using non-synthetic oil.

Every 600 Hours¹

- Replace air cleaner inner element (if equipped).

Every 600 Hours^{1,3}

- Have valve lash checked/adjusted.

Every 1500 Hours^{1,2}

- Have vaporizer/regulator tested.

¹ Perform these procedures more frequently under severe, dusty, dirty conditions.

² Must be performed by a Kohler authorized dealer or qualified propane personnel only.

³ Have a Kohler authorized dealer perform this service.

Oil Recommendations

Synthetic oil is recommended for use in propane fueled engines. Non-synthetic oil must be low ash* rated oil. Oils (including synthetic) must meet API (American Petroleum Institute) service class SG, SH, SJ, or SL. Select viscosity based on air temperature at time of operation as shown in table below.

*Low ash is defined as less than 1% sulfated ash.

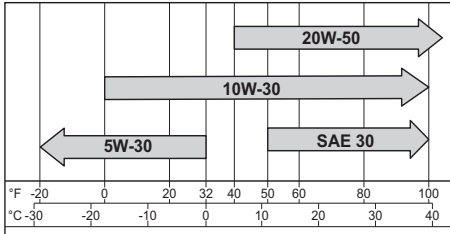

Check Oil Level

NOTE: To prevent extensive engine wear or damage, never run engine with oil level below or above operating range indicator on dipstick.

Ensure engine is cool. Clean oil fill/dipstick areas of any debris.

1. Remove dipstick; wipe oil off.
2. Reinsert dipstick into tube; press completely down.
3. Remove dipstick; check oil level. Level should be at top of indicator on dipstick.
4. If oil is low on indicator, add oil up to top of indicator mark.
5. Reinstall and secure dipstick.

Change Oil and Filter

Change oil while engine is warm.

1. Clean area around oil fill cap/dipstick and drain plug. Remove drain plug and oil fill cap/dipstick. Allow oil to drain completely.
2. Clean area around oil filter. Place a container under filter to catch any oil and remove filter. Wipe off mounting surface. Reinstall drain plug. Torque to 15.7 ft. lb. (21.4 N·m).
3. Place new filter in shallow pan with open end up. Fill with new oil until oil reaches bottom of threads. Allow 2 minutes for oil to be absorbed by filter material.
4. Apply a thin film of clean oil to rubber gasket on new filter.
5. Refer to instructions on oil filter for proper installation.
6. Fill crankcase with new oil. Level should be at top of indicator on dipstick.
7. Reinstall oil fill cap/dipstick and tighten securely.
8. Start engine; check for oil leaks. Stop engine; correct leaks. Recheck oil level.
9. Dispose of used oil and filter in accordance with local ordinances.

Oil Sentry™ (if equipped)

This switch is designed to prevent engine from starting in a low oil or no oil condition. Oil Sentry™ may not shut down a running engine before damage occurs. In some applications this switch may activate a warning signal. Read your equipment manuals for more information.

Fuel Recommendations

	<p>⚠ WARNING</p> <p>Explosive Fuel can cause fires and severe burns.</p> <p>If a gaseous odor is detected, ventilate area and contact an authorized service technician.</p>
	<p>Propane is extremely flammable and is heavier than air and tends to settle in low areas where a spark or flame could ignite gas. Do not start or operate this engine in a poorly ventilated area where leaking gas could accumulate and endanger safety of persons in area.</p> <p>To ensure personal safety, installation and repair of propane fuel supply systems must be performed only by qualified propane system technicians. Improperly installed and maintained propane equipment could cause fuel supply system or other components to malfunction, causing gas leaks.</p> <p>Observe federal, state and local laws governing propane fuel, storage, and systems.</p>

This engine is certified to operate on commercial propane with a minimum propane content of 85% (per GPA STD 2140). If you have any questions, contact your propane supplier.

Propane from an appropriate propane fuel tank (supplied separately) is required to operate this engine.

Vaporizer/Regulator

In compliance with government emission standards, vaporizer/regulator is preset at factory to provide proper supply of fuel. No adjustment or resetting of vaporizer/regulator is to be made. All service relating to vaporizer/regulator must be performed by a Kohler authorized dealer or qualified propane personnel only.

Vaporizer/regulator can change propane from supply tank to a gaseous/vapor state.

Lock-Off assembly opens and closes controlling fuel flow from supply tank before reaching vaporizer/regulator.

Over time, fuel deposits can accumulate inside vaporizer/regulator. Removing these deposits is recommended. Follow steps below to drain vaporizer/regulators.

1. Turn fuel supply valve off, run engine out of fuel, and turn off ignition switch.
2. Disconnect and ground spark plug leads.
3. Remove drain plug from bottom of vaporizer/regulator. Remove any accumulated deposits.

4. Reinstall plug and tighten securely. If required, a replacement plug can be found at KohlerEngines.com. EN

Fuel Line

High pressure fuel line meeting a minimum of SAE R7 standard must be installed on Kohler Co. engines equipped with propane EFI system (from vaporizer/regulator to injectors).

Spark Plugs

	<p>⚠ CAUTION</p> <p>Electrical Shock can cause injury.</p> <p>Do not touch wires while engine is running.</p>
	<p>Clean out spark plug recess. Remove plug and replace.</p> <ol style="list-style-type: none"> 1. Check gap using wire feeler gauge. Adjust gap, see specification table for adjustment. 2. Install plug into cylinder head. 3. Torque plug to 20 ft. lb. (27 N·m).

Clean out spark plug recess. Remove plug and replace.

1. Check gap using wire feeler gauge. Adjust gap, see specification table for adjustment.
2. Install plug into cylinder head.
3. Torque plug to 20 ft. lb. (27 N·m).

Jump Starting

Follow all safety guidelines and procedures provided by battery manufacturer and/or original equipment manufacturer (OEM). Failure to follow proper procedures may result in serious personal injury and/or non-warrantable damage to engine's EFI components.

Electronic Fuel Injection (EFI) System

EFI is an electronically-controlled fuel management system which is monitored by an Electronic Control Unit (ECU). A Malfunction Indicator Light (MIL) will illuminate if problems or faults are detected. Servicing by a Kohler authorized dealer is necessary.

Fuel System Components

Engines are equipped with special EFI fuel filters. See Maintenance Schedule.

Fuse Replacement

This engine has three (3) blade type automotive fuses. Replacement fuses must have same rating as blown fuse. Use fuse chart below to determine correct fuse.

Wire Color	Fuse Rating
2 Solid Red Wires	10-amp Fuse
1 Red Wire with Black Stripe 1 Red Wire with White Stripe	10-amp Fuse
2 Purple Wires	30-amp Fuse

Air Cleaner

NOTE: Operating engine with loose or damaged air cleaner components could cause premature wear and failure. Replace all bent or damaged components.

NOTE: Paper element cannot be blown out with compressed air.

1. Unhook retaining clips and remove end cap(s).
2. Check and clean inlet screen (if equipped).
3. Pull air cleaner element out of housing and replace. Check condition of inner element (if equipped); replace when dirty.
4. Check all parts for wear, cracks, or damage, and that ejector area is clean.
5. Install new element(s).
6. Reinstall end cap(s) with dust ejector valve/screen down; secure with retaining clips.

Breather Tube

Ensure both ends of breather tube are properly connected.

Oil Cooler (if equipped)

1. Clean fins with a brush or compressed air.
2. Remove two screws securing oil cooler, and tilt to clean back side.
3. Reinstall oil cooler.

Air Cooling

	WARNING
	Hot Parts can cause severe burns. Do not touch engine while operating or just after stopping.
Never operate engine with heat shields or guards removed.	

Proper cooling is essential. To prevent over heating, clean screens, cooling fins, and other external surfaces of engine. Avoid spraying water at wiring harness or any electrical components. See Maintenance Schedule.

Repairs/Service Parts

We recommend that you use a Kohler authorized dealer for all maintenance, service, and engine parts. To find a Kohler authorized dealer visit KohlerEngines.com or call 1-800-544-2444 (U.S. and Canada).

Storage

If engine will be out of service for 2 months or more follow procedure below.

1. Change oil while engine is still warm from operation. Remove spark plug(s) and pour about 1 oz. of engine oil into cylinder(s). Replace spark plug(s) and crank engine slowly to distribute oil.
2. Disconnect negative (-) battery cable.
3. Separate propane tank from unit and store separately in an area designated for safe propane tank storage.
4. Store engine in a clean, dry place.

Troubleshooting

Do not attempt to service or replace major engine components, or any items that require special timing or adjustment procedures. This work should be performed by a Kohler authorized dealer.

Problem	Possible Cause											
	No Fuel	Tank Nearly Empty	Improper Fuel	Dirt In Fuel Line	Broken Fusible Link	Dirty/ Restricted Vaporizer/ Regulator Inlet Filter	Dirty Debris Screen	Incorrect Oil Level	Engine Overloaded	Dirty Air Cleaner	Faulty Spark Plug	Dirty/ Restricted Vaporizer/ Regulator
Will Not Start	•			•	•	•	•	•	•	•	•	•
Hard Starting	•		•	•		•	•	•	•	•	•	•
Stops Suddenly	•			•		•	•	•	•	•		•
Lacks Power		•	•	•		•	•	•	•	•	•	•
Operates Erratically			•	•		•	•	•	•	•	•	•
Knocks or Pings			•			•		•			•	•
Skips or Misfires			•	•		•	•			•	•	•
Backfires				•		•				•	•	•
Overheats			•	•		•		•		•		•
High Fuel Consumption										•		

Engine Specifications

Model	Bore	Stroke	Displacement	Oil Capacity (Refill)	Spark Plug Gap	Maximum Angle of Operation (@ full oil level)*
PCV850	3.39 in.	2.79 in.	50.3 cu. in.	2.7 U.S. qt.	0.030 in.	25°
PCV860	(86 mm)	(70.9 mm)	(824 cc)	(2.6 L)	(0.76 mm)	

*Exceeding maximum angle of operation may cause engine damage from insufficient lubrication.

Additional specification information can be found in service manual at KohlerEngines.com.

Any and all horsepower (hp) references by Kohler are Certified Power Ratings and per SAE J1940 & J1995 hp standards. Details on Certified Power Ratings can be found at KohlerEngines.com.

Emission Control System

Exhaust Emission Control System for models PCV850 and PCV860 is EM, O2S, ECM, MPI for U.S. EPA, California, and Europe.

NOTE: Tampering with the engine and its emission control system voids the EPA Certificate of Conformity, ARB Executive Order, and EU type-approval.