

KOHLER[®] HD Series[™]

HD675, HD775, HD950, HD1100

Owner's Manual

EN

ESS

FRC

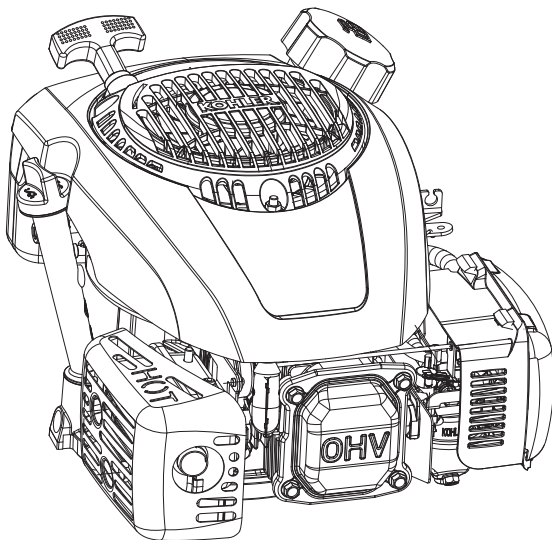

IMPORTANT:

Read all safety precautions and instructions carefully before operating equipment. Refer to operating instruction of equipment that this engine powers.

Ensure engine is stopped and level before performing any maintenance or service.

Warranty coverage as outlined in the warranty card and on KohlerEngines.com. Please review carefully as it provides your specific rights and obligations.

To maintain compliance with applicable emission regulations, exhaust system backpressure may not exceed limits which can be found on KohlerEngines.com. Search by Model No., then select Specs tab.

Kohler Engines has published CO₂ values on KohlerEngines.com website.

Record engine information to reference when ordering parts or obtaining warranty coverage.

Engine Model _____

Specification _____

Serial Number _____

Purchase Date _____

Safety Precautions

⚠ WARNING: A hazard that could result in death, serious injury, or substantial property damage.

⚠ CAUTION: A hazard that could result in minor personal injury or property damage.

NOTE: is used to notify people of important installation, operation, or maintenance information.

	<p>⚠ WARNING</p> <p>Explosive Fuel can cause fires and severe burns.</p> <p>Do not fill fuel tank while engine is hot or running.</p>
	<p>Gasoline is extremely flammable and its vapors can explode if ignited. Store gasoline only in approved containers, in well ventilated, unoccupied buildings, away from sparks or flames. Spilled fuel could ignite if it comes in contact with hot parts or sparks from ignition. Never use gasoline as a cleaning agent.</p>

	<p>⚠ WARNING</p> <p>Carbon Monoxide can cause severe nausea, fainting or death.</p> <p>Avoid inhaling exhaust fumes. Never run engine indoors or in enclosed spaces.</p>
	<p>Engine exhaust gases contain poisonous carbon monoxide. Carbon monoxide is odorless, colorless, and can cause death if inhaled.</p>

	<p>⚠ WARNING</p> <p>Accidental Starts can cause severe injury or death.</p> <p>Disconnect and ground spark plug lead(s) before servicing.</p>
	<p>Before working on engine or equipment, disable engine as follows: 1) Disconnect spark plug lead(s). 2) Disconnect negative (-) battery cable from battery.</p>

	<p>⚠ WARNING</p> <p>Rotating Parts can cause severe injury.</p> <p>Stay away while engine is in operation.</p>
	<p>Keep hands, feet, hair, and clothing away from all moving parts to prevent injury. Never operate engine with covers, shrouds, or guards removed.</p>

	<p>⚠ CAUTION</p> <p>Electrical Shock can cause injury.</p> <p>Do not touch wires while engine is running.</p>
---	--

	<p>⚠ WARNING</p> <p>Hot Parts can cause severe burns.</p> <p>Do not touch engine while operating or just after stopping.</p>
	<p>Never operate engine with heat shields or guards removed.</p>

⚠ WARNING: This product can expose you to chemicals including carbon monoxide and benzene, which are known to the State of California to cause cancer and birth defects or other reproductive harm. For more information go to www.P65Warnings.ca.gov.

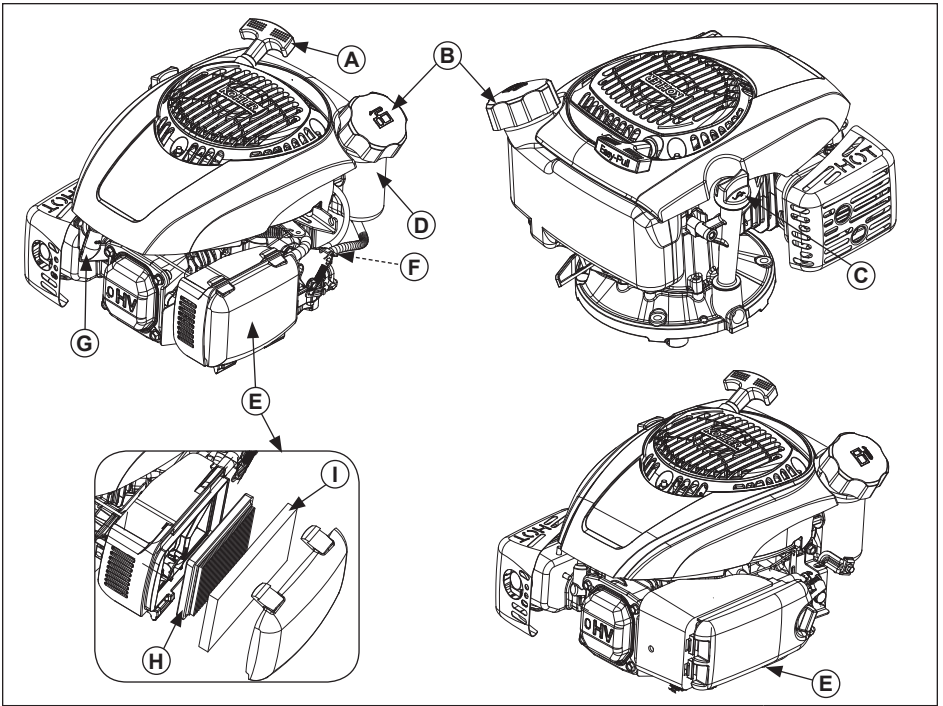

A	Starter Handle	B	Fuel Cap	C	Oil Fill Cap/ Dipstick	D	Fuel Tank
E	Air Cleaner	F	Fuel Shut-Off Valve	G	Spark Plug	H	Element
I	Precleaner						

Visit KohlerEngines.com for service parts information and purchasing options.

Pre-Start Checklist

1. Check oil level. Add oil if low. Do not overfill.
2. Check fuel level. Add fuel if low. Check fuel system components and lines for leaks.
3. Check and clean cooling areas, air intake areas and external surfaces of engine (particularly after storage).
4. Check that air cleaner components and all shrouds, equipment covers, and guards are in place and securely fastened.
5. Check spark arrestor (if equipped).

Starting

	! WARNING
	Carbon Monoxide can cause severe nausea, fainting or death. Avoid inhaling exhaust fumes. Never run engine indoors or in enclosed spaces.
Engine exhaust gases contain poisonous carbon monoxide. Carbon monoxide is odorless, colorless, and can cause death if inhaled.	

	! WARNING
	Rotating Parts can cause severe injury. Stay away while engine is in operation.
Keep hands, feet, hair, and clothing away from all moving parts to prevent injury. Never operate engine with covers, shrouds, or guards removed.	

NOTE: Choke position for starting may vary depending upon temperature and other factors. Once engine is running and warm, turn choke to OFF position.

NOTE: Extend starter cord periodically to check its condition. If cord is frayed have it replaced immediately by a Kohler authorized dealer.

1. Turn fuel shut-off valve to ON position (if equipped).
2. Turn engine on/off switch to ON position (if equipped).
3. Start engine as follows:
 - a. Manual Choke Models:
Cold engine: Place throttle control to FAST position. Pull choke control into CHOKE/ON position.
Warm engine: place throttle control to RUN/FAST position.
or
 - b. Smart-Choke™ Models: this feature automatically adjusts choke on start-up.
4. Retractable Start: Slowly pull starter handle until just past compression-STOP! Return starter handle; firmly pull straight out to avoid excessive rope wear from starter rope guide.
Electric Start: Key switch (refer to operating instructions of equipment that this engine powers). If equipped with Smart-Choke™ stop here, otherwise continue to step 5.

5. Gradually return choke control to OFF position after engine starts and warms up. Engine/equipment may be operated during warm up period, but it may be necessary to leave choke partially on until engine warms up.

Cold Weather Starting Hints

1. Use proper oil for temperature expected.
2. Disengage all possible external loads.
3. Use fresh winter grade fuel. Winter grade fuel is formulated to improve starting.

Stopping

1. If possible, remove load by disengaging all PTO driven attachments.
2. If equipped, move throttle control to slow or idle position; stop engine.
3. If equipped, close fuel shut-off valve.

Angle of Operation

Refer to operating instructions of equipment this engine powers. Do not operate this engine exceeding maximum angle of operation; see specification table. Engine damage could result from insufficient lubrication.

Engine Speed

NOTE: Do not tamper with governor setting to increase maximum engine speed. Overspeed is hazardous and will void warranty.



High Altitude Operation

If this engine is operated at an altitude of 4000 ft. (1219 meters) or above, a high altitude carburetor kit is required. To obtain high altitude carburetor kit information or to find a Kohler authorized dealer, visit KohlerEngines.com or call 1-800-544-2444 (U.S. and Canada).

This engine should be operated in its original configuration below 4000 ft. (1219 meters).

Operating this engine with the wrong engine configuration at a given altitude may increase its emissions, decrease fuel efficiency and performance, and result in damage to the engine.

Maintenance Instructions

	 WARNING	Before working on engine or equipment, disable engine as follows: 1) Disconnect spark plug lead(s). 2) Disconnect negative (-) battery cable from battery.
	Accidental Starts can cause severe injury or death. Disconnect and ground spark plug lead(s) before servicing.	

Normal maintenance, replacement or repair of emission control devices and systems may be performed by any repair establishment or individual; however, warranty repairs must be performed by a Kohler authorized dealer found at KohlerEngines.com or 1-800-544-2444 (U.S. and Canada).

Maintenance Schedule

Before Every Use

- Check oil level. Add oil if low. Do not overfill.
- Check air cleaner for dirty, loose, or damaged parts.
- Check precleaner for dirty or torn material.

After first 3-5 Hours (approximately 3rd to 5th use)

- Change oil.

Every 25 Hours or Annually¹

- Service/replace precleaner.

Every 50 Hours or Annually¹

- Change oil.
- Replace air cleaner element.
- Replace fuel filter (if equipped).

Every 100 Hours or Annually¹

- Clean spark arrestor (if equipped).

Every 125 Hours or Annually¹

- Replace spark plug and set gap.

¹ Perform these procedures more frequently under severe, dusty, dirty conditions.

Oil Recommendations

We recommend use of Kohler oils for best performance. Other high-quality detergent oils (including synthetic) of API (American Petroleum Institute) service class SJ or higher are acceptable. Select viscosity based on air temperature at time of operation as shown in table below.

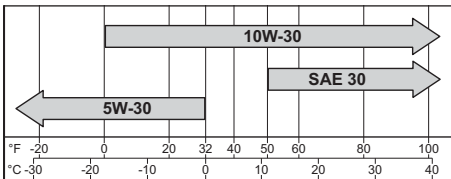

Check Oil Level

NOTE: To prevent extensive engine wear or damage, never run engine with oil level below or above operating range indicator on dipstick.

Ensure engine is cool. Clean oil fill cap/dipstick areas of any debris.

- Remove dipstick; wipe oil off.
 - 1/4 turn cap: reinsert dipstick into tube; press completely down and turn 1/4 turn.
or
 - Threaded cap: reinsert dipstick into tube; rest cap on tube, do not thread cap onto tube.
- Remove dipstick; check oil level. Level should be at top of indicator on dipstick.
- If oil is low on indicator, add oil up to top of indicator mark.
- Reinstall and secure dipstick.

Change Oil

Change oil while engine is warm.

Dipstick tube:

1. Clean area around oil fill cap/dipstick.
2. Remove oil fill cap/dipstick. Tilt engine on its side with air cleaner facing up. Drain oil into appropriate container.
3. After crankcase is drained completely, tilt engine upright.
4. Fill crankcase with new oil. Level should be at top of indicator on dipstick.
5. Reinstall oil fill cap/dipstick and tighten securely.
6. Dispose of used oil in accordance with local ordinances.

Crankcase plug:

1. Disable engine by disconnecting spark plug.
2. Clean area around oil fill cap/dipstick. Remove oil fill cap/dipstick.
3. Remove crankcase plug on bottom of engine; drain oil into appropriate container.
4. Apply thread sealant around three full threads of drain plug; reinstall drain plug. Torque to 120 in. lb. (13.6 N·m).
5. Fill crankcase with new oil. Level should be at top of indicator on dipstick.
6. Reinstall oil fill cap/dipstick and tighten securely.
7. Dispose of used oil in accordance with local ordinances.

Fuel Recommendations

	<p>! WARNING</p> <p>Explosive Fuel can cause fires and severe burns.</p> <p>Do not fill fuel tank while engine is hot or running.</p>
<p>Gasoline is extremely flammable and its vapors can explode if ignited. Store gasoline only in approved containers, in well ventilated, unoccupied buildings, away from sparks or flames. Spilled fuel could ignite if it comes in contact with hot parts or sparks from ignition. Never use gasoline as a cleaning agent.</p>	

NOTE: E15, E20 and E85 are NOT approved and should NOT be used; effects of old, stale or contaminated fuel are not warrantable.

Fuel must meet these requirements:

- Clean, fresh, unleaded gasoline.
- Octane rating of 87 (R+M)/2 or higher.
- Research Octane Number (RON) 90 octane minimum.

- Gasoline up to 10% ethyl alcohol, 90% unleaded is acceptable.
- Methyl Tertiary Butyl Ether (MTBE) and unleaded gasoline blend (max 15% MTBE by volume) are approved.
- Do not add oil to gasoline.
- Do not overfill fuel tank.
- Do not use gasoline older than 30 days.

Add Fuel

	<p>! WARNING</p> <p>Explosive Fuel can cause fires and severe burns.</p> <p>Do not fill fuel tank while engine is hot or running.</p>
<p>Gasoline is extremely flammable and its vapors can explode if ignited. Store gasoline only in approved containers, in well ventilated, unoccupied buildings, away from sparks or flames. Spilled fuel could ignite if it comes in contact with hot parts or sparks from ignition. Never use gasoline as a cleaning agent.</p>	

Ensure engine is cool.

1. Clean area around fuel cap.
2. Remove fuel cap. Fill to base of filler neck. Do not overfill fuel tank. Leave room for fuel to expand.
3. Reinstall fuel cap and tighten securely.

Fuel Line

Low permeation fuel line must be installed on carbureted Kohler Co. engines to maintain EPA and CARB regulatory compliance.

Spark Plugs



CAUTION

Electrical Shock can cause injury.
Do not touch wires while engine is running.

Clean out spark plug recess. Remove plug and replace.

1. Check gap using wire feeler gauge. Adjust gap, see specification table for adjustment.
2. Install plug into cylinder head.
3. Torque plug to 20 ft. lb. (27 N·m).

Air Cleaner

NOTE: Operating engine with loose or damaged air cleaner components could cause premature wear and failure. Replace all bent or damaged components.

NOTE: Paper element cannot be blown out with compressed air.

Loosen knob or unhook latches and remove air cleaner cover.

Precleaner (if equipped):

1. Remove precleaner.
2. Replace or wash precleaner in warm water with detergent. Rinse and allow to air dry.
3. Reinstall precleaner into cover, aligning hole in precleaner with upper cover knob.

Paper Element:

1. Remove paper element from base and replace.
2. Install element with pleated side out and seat rubber seal onto edges of base.

Foam Element:

1. Remove foam element from base and replace.
2. Install element with foam side out and seat rubber seal onto edges of base.

Reinstall air cleaner cover and secure with knob or latches.

Breather Tube

Ensure both ends of breather tube are properly connected.

Air Cooling



WARNING

Hot Parts can cause severe burns.

Do not touch engine while operating or just after stopping.

Never operate engine with heat shields or guards removed.

Proper cooling is essential. To prevent over heating, clean screens, cooling fins, and other external surfaces of engine. Avoid spraying water at wiring harness or any electrical components. See Maintenance Schedule.

Repairs/Service Parts

We recommend that you use a Kohler authorized dealer for all maintenance, service, and replacement parts for engine. To find a Kohler authorized dealer visit KohlerEngines.com or call 1-800-544-2444 (U.S. and Canada).

Storage

If engine will be out of service for 2 months or more follow procedure below.

1. Add Kohler PRO Series fuel treatment or equivalent to fuel tank. Run engine 2-3 minutes to get stabilized fuel into fuel system (failures due to untreated fuel are not warrantable).
2. Change oil while engine is still warm from operation. Remove spark plug(s) and pour about 1 oz. of engine oil into cylinder(s). Replace spark plug(s) and crank engine slowly to distribute oil.
3. Disconnect negative (-) battery cable.
4. Store engine in a clean, dry place.

Troubleshooting

Do not attempt to service or replace major engine components, or any items that require special timing or adjustment procedures. This work should be performed by a Kohler authorized dealer.

Problem	Possible Cause							
	No Fuel	Improper Fuel	Dirt In Fuel Line	Dirty Debris Screen	Incorrect Oil Level	Engine Overloaded	Dirty Air Cleaner	Faulty Spark Plug
Will Not Start	•	•	•		•	•	•	•
Hard Starting		•	•		•	•	•	•
Stops Suddenly	•		•	•	•	•	•	•
Lacks Power		•	•	•	•	•	•	•
Operates Erratically		•	•	•		•	•	•
Knocks or Pings		•		•		•		•
Skips or Misfires		•	•	•			•	•
Backfires		•	•			•	•	•
Overheats		•	•	•	•	•	•	
High Fuel Consumption						•	•	•

Engine Specifications

Model	Bore	Stroke	Displacement	Oil Capacity (Refill)	Spark Plug Gap	Maximum Angle of Operation (@ full oil level)*
HD675	2.56 in. (65 mm)	1.80 in. (45 mm)	9.1 cu. in. (149 cc)	20 oz. (0.60 L)	0.030 in. (0.76 mm)	20°
HD775	2.75 in. (70 mm)		10.6 cu. in. (173 cc)			
HD950	2.87 in. (73 mm)	1.89 in. (48 mm)	12.2 cu. in. (200 cc)			
HD1100		2.11 in. (53.5 mm)	13.7 cu. in. (224 cc)			

*Exceeding maximum angle of operation may cause engine damage from insufficient lubrication.

Additional specification information can be found in service manual at KohlerEngines.com.

Any and all horsepower (hp) references by Kohler are Certified Power Ratings and per SAE J1940 & J1995 hp standards. Details on Certified Power Ratings can be found at KohlerEngines.com.

Emission Control System

Exhaust Emission Control System for models HD675, HD775, HD950, and HD1100 is EM for U.S. EPA, California, and Europe.

NOTE: Tampering with the engine and its emission control system voids the EPA Certificate of Conformity, ARB Executive Order, and EU type-approval.