



PAS-225 / 225SB

Pro Attachment Series™

Operator's Manual

WARNING



Burn Hazard

The muffler or catalytic muffler and surrounding cover may become extremely hot.

Always keep clear of exhaust and muffler area, otherwise serious personal injury may occur.

WARNING

The engine exhaust from this product contains chemicals known to the State of California to cause cancer, birth defects or other reproductive harm.

WARNING



Users of this equipment risk injury to themselves and others if the unit is used improperly and/or safety precautions are not followed. ECHO provides an operator's manual and a safety manual. Both must be read and understood for proper and safe operation. Failure to do so could result in

serious injury.

Note: This product complies with CAN ICES-2/NMB-2

Specifications, descriptions and illustrative material in this literature are as accurate as known at the time of publication, but are subject to change without notice. Illustrations may include optional equipment and accessories, and may not include all standard equipment.

TABLE OF CONTENTS

Table of Contents 2

Introduction 4

 The Operator’s Manual 4

 The Safety Manual 4

Servicing Information 4

 Parts/Serial Number 4

 Service 5

 Echo Consumer Product Support 5

 Product Registration 5

 Additional or Replacement Manuals 5

Safety 5

 Manual Safety Symbols and Important Information 5

 International Symbols 6

 Personal Condition and Safety Equipment 8

 Equipment 13

Emission Control (Exhaust & Evaporative) 14

 CARB And EPA Emissions Control Information 14

Description 15

Contents 19

Assembly 20

 Power Head Shaft/Lower Shaft Assembly 20

 Support Handle Installation 20

Operation 21

 Fuel 21

 Operation With Blades 24

 Blade Selection 25

 Starting Cold Engine 26

 Starting Warm Engine 27

 Stopping Engine 28

Maintenance	29
Skill Levels.....	29
Maintenance Intervals	29
Air Filter	30
Fuel Filter	31
Spark Plug.....	32
Cooling System	32
Exhaust System	34
Carburetor Adjustment	35
Lubrication.....	36
PAS-225 SB Only:	37
Lubrication.....	37
Nylon Line Head Disassembly Instructions	38
Nylon Line Replacement	38
Sharpening Metal Blades	40
Troubleshooting	41
Storage	42
Long Term Storage (Over 30 Days).....	43
PAS-225 SB Only:	43
Storage Hook Installation	43
Specifications	44
ECHO Optional Attachments.....	46
Product Registration	48

INTRODUCTION

Welcome to the ECHO family. This ECHO product was designed and manufactured to provide long life and on-the-job dependability. Read and understand this manual and the SAFETY MANUAL. You will find both easy to use and full of helpful operating tips and SAFETY messages.

The Operator's Manual

Keep it in a safe place for future reference. Contains specifications and information for safety, operation, maintenance, storage and assembly specific to this product. Scan QR codes throughout the operator's manual for more information.

The Safety Manual

Keep it in a safe place for future reference. Explains possible hazards and the measures you should take to insure safe operation.

SERVICING INFORMATION

Parts/Serial Number

Genuine ECHO Parts, assemblies and maintenance kits for your ECHO products are available from an Authorized ECHO Dealer. When you do need to buy parts **always** have the Model Number and Serial Number of the unit with you. You can find these numbers on the engine housing. For future reference, write them in the space provided below.



Model No. _____ Serial No. _____

Service

Service of this product during the warranty period must be performed by an Authorized ECHO Service Dealer. For the name and address of the Authorized ECHO Service Dealer nearest you, ask your retailer or call: 1-800-432-ECHO (3246). Dealer information is also available on our Web Site. When presenting your unit for Warranty service/repairs, proof of purchase is required.

Echo Consumer Product Support

If you require assistance or have questions concerning the application, operation or maintenance of this product you may call the ECHO Consumer Product Support Department at 1-800-673-1558 from 8:00 am to 5:00 pm (Central Standard Time) Monday through Friday. Before calling, please know the model and serial number of your unit.

Product Registration

To ensure trouble free warranty coverage it is important that you register your ECHO equipment on-line at www.echo-usa.com or by filling out the product registration sheet included in this manual. Registering your product confirms your warranty coverage and provides a direct link between you and ECHO if we find it necessary to contact you.

Additional or Replacement Manuals

Replacement Operator, Safety Manuals, and Parts Catalogs are available from your ECHO dealer or at www.echo-usa.com or by contacting ECHO Inc., 400 Oakwood Road, Lake Zurich, IL 60047 (800-673-1558). Always check the ECHO Web Site for updated information.



Safety Videos are available from your Echo dealer. A \$5.00 shipping charge will be required for each video.

SAFETY

Manual Safety Symbols and Important Information

Throughout this manual and on the product itself, you will find safety alerts and helpful, informational messages preceded by symbols or key words. The following is an explanation of those symbols and key words and what they mean to you.

DANGER

The safety alert symbol accompanied by the word “DANGER” calls attention to an act or condition which WILL lead to serious personal injury or death if not avoided.

WARNING

The safety alert symbol accompanied by the word “WARNING” calls attention to an act or condition which CAN lead to serious personal injury or death if not avoided.

CAUTION

The safety alert symbol accompanied by the word “CAUTION” calls attention to an act or condition which may lead to minor or moderate personal injury if not avoided.

NOTICE

The enclosed message provides information necessary for the protection of the unit.





Note: This enclosed message provides tips for use, care and maintenance of the unit.















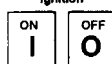





CIRCLE AND SLASH SYMBOL

This symbol means the specific action shown is prohibited. Ignoring these prohibitions can result in serious or fatal injury.

International Symbols

Symbol	Description	Symbol	Description
	Warning, See Operator's Manual	H	Carburetor Adjustment - High Speed Mixture
	Wear Eye, Ear and Head Protection	T	Carburetor Adjustment - Idle Speed
	Wear Hand and Foot Protection	L	Carburetor Adjustment - Low Speed Mixture
	Safety/Alert		Emergency Stop

Symbol	Description	Symbol	Description
	Hot Surface		Fuel and Oil Mixture
		<p>AVOID KICKOUT. Keep Bystanders At Least 15 meters (50 feet) Away.</p> <p>Beware Thrown Objects Wear Eye Protection</p>	
		Keep Bystanders and Helpers Away 15 m (50 ft.).	
	DO NOT Allow Flames or Sparks Near Fuel	<p>Ignition</p> 	Ignition ON / OFF
	DO NOT Smoke Near Fuel		Primer Bulb
	Choke Control "RUN" Position (Choke Open)		Choke Control "COLD START" Position (Choke Closed)
	Keep Feet Away From Blade		Rotating Cutting Attachment
	Thrown Objects		Wear face shield.
	Finger Severing		Wear slip resistant footwear

Symbol	Description	Symbol	Description
	Do not operate closer than 15 M (50 ft.) from electrical hazards. Keep bystanders atleast 15 meters (50 feet) away.		DO NOT USE BLADES - Line Head Only
	Plan retreat path from falling objects.		



LOOK BEFORE YOU PUMP!
Ethanol Percentage

0% - 10%	15% - 30% - 50% - 85%
----------	-----------------------

USE E10 OR LESS FUEL

Do not use any fuel containing greater than 10 percent ethanol (E10) in this equipment. It may cause damage or failure and is prohibited by Federal Law.
For Details, see the "Fuel" Section of your Operators Manual.

Personal Condition and Safety Equipment

! WARNING

Users of this product risk injury to themselves and others if the unit is used improperly and/or safety precautions are not followed. Proper clothing and safety gear must be worn when operating unit.

Physical Condition

Your judgment and physical dexterity may not be good:

- If you are tired or sick.
- If you are taking medication.

- If you have taken alcohol or drugs.

Operate unit only if you are physically and mentally well.

Eye Protection

WARNING

- ◆ **Eye protection that meets ANSI Z87.1 or CE requirements must be worn whenever you operate the unit.**
- ◆ **For additional safety, a full-face shield may be worn over safety glasses or goggles to provide protection from sharp branches or flying debris.**

Hand Protection

Wear sturdy, no-slip, rubber work gloves to improve your grip on the handles. Gloves also provide protection against cuts and scratches, cold environments, and reduce the transmission of machine vibration to your hands.

Hearing/Ear Protection

ECHO recommends wearing hearing protection whenever unit is used.

Breathing Protection

Operators who are sensitive to dust or other common airborne allergens may need to wear a dust mask to prevent inhaling these materials while operating unit. Dust masks can provide protection against dust, plant debris, and other plant matter such as pollen. Make sure the mask does not impair your vision, and replace the mask as needed to prevent air restrictions.

Proper Clothing

Wear snug-fitting, durable clothing:

- Pants should have long legs, shirts should have long sleeves.
- **DO NOT WEAR SHORTS.**
- **DO NOT WEAR TIES, SCARVES, JEWELRY,** or clothing with loose or hanging items that could become entangled in moving parts or surrounding growth.
- Keep clothing buttoned or zipped, and keep shirt tails tucked in.

Wear sturdy work shoes with nonskid rubber soles:

- **DO NOT WEAR OPEN TOED SHOES.**

- DO NOT OPERATE UNIT BAREFOOTED.

Keep long hair away from engine and air intake. Retain hair with cap or net.

Heavy protective clothing can increase operator fatigue, which may lead to heat stroke. Schedule heavy work for early morning or late afternoon hours when temperatures are cooler.

WARNING

The components of this machine generate an electromagnetic field during operation, which may interfere with some pacemakers. To reduce the risk of serious or fatal injury, persons with pacemakers should consult with their physician and the pacemaker manufacturer before operating this machine. In the absence of such information, ECHO does not recommend the use of this machine by anyone who has a pacemaker.

Extended Operation / Extreme Conditions

CAUTION

Prolonged exposure to cold and/or vibration may result in injury. Read and follow all safety and operation instructions to minimize risk of injury. Failure to follow instructions may result in painful wrist/hand/arm injuries.

It is believed that a condition called Raynaud's Phenomenon, which affects the fingers of certain individuals, may be brought about by exposure to vibration and cold. Exposure to vibration and cold may cause tingling and burning sensations, followed by loss of color and numbness in the fingers. The following precautions are strongly recommended, because the minimum exposure, which might trigger the ailment, is unknown.

- Keep your body warm, especially the head, neck, feet, ankles, hands, and wrists.
- Maintain good blood circulation by performing vigorous arm exercises during frequent work breaks, and also by not smoking.
- Limit the hours of operation. Try to fill each day with jobs where operating the unit or other hand-held power equipment is not required.
- If you experience discomfort, redness, and swelling of the fingers followed by whitening and loss of feeling, consult your physician before further exposing yourself to cold and vibration.

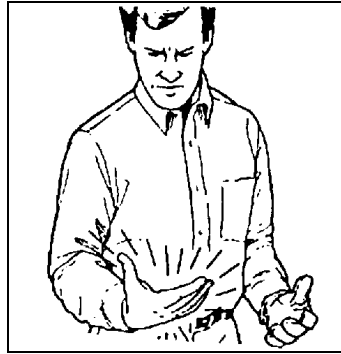

Repetitive Stress Injuries (RSI)

It is believed that overusing the muscles and tendons of the fingers, hands, arms, and shoulders may cause soreness, swelling, numbness, weakness, and extreme pain in those areas. Certain repetitive hand activities may put you at a high risk for developing a Repetitive Stress Injury (RSI). An extreme RSI condition is Carpal Tunnel Syndrome (CTS), which could occur when your wrist swells and squeezes a vital nerve that runs through the area. Some believe that prolonged exposure to vibration may contribute to CTS. CTS can cause severe pain for months or even years.



To reduce the risk of RSI/CTS, do the following:

- Avoid using your wrist in a bent, extended, or twisted position. Instead try to maintain a straight wrist position. Also, when grasping, use your whole hand, not just the thumb and index finger.
- Take periodic breaks to minimize repetition and rest your hands.
- Reduce the speed and force with which you do the repetitive movement.
- Do exercises to strengthen the hand and arm muscles.

- Immediately stop using all power equipment and consult a doctor if you feel tingling, numbness, or pain in the fingers, hands, wrists, or arms. The sooner RSI/CTS is diagnosed, the more likely permanent nerve and muscle damage can be prevented.

DANGER

All over head electrical conductors and communications wires can have electricity flow with high voltages. This unit is not insulated against electrical current. Never touch wires directly or indirectly, otherwise serious injury or death may result.

DANGER

Do not operate this product indoors or in inadequately ventilated areas. Engine exhaust contains poisonous emissions and can cause serious injury or death.

Read the Manuals

- Provide all users of this equipment with the Operator's Manual and Safety Manual for instructions on Safe Operation.

Clear the Work Area

- Spectators and fellow workers must be warned, and children and animals prevented from coming nearer than 15 m (50 ft.) while the unit is in use.

Keep a Firm Grip

- Always hold throttle handle and support handle with thumbs and fingers tightly encircling the handles.

Keep a Solid Stance

- Maintain footing and balance at all times. Do not stand on slippery, uneven or unstable surfaces. Do not work in odd positions or on ladders. Do not over reach.



Avoid Hot Surfaces

- During operation, the drive shaft housing and attachment bearing housing may become very hot, too hot to touch. Avoid contact during and immediately after operation.



Equipment

WARNING

Use only ECHO attachments. Serious injury may result from the use of a non-approved attachment combination. ECHO, INC. will not be responsible for the failure of cutting devices, attachments or accessories which have not been tested and approved by ECHO. Read and comply with all safety instructions listed in this manual and safety manual.

- Check unit for loose/missing nuts, bolts, and screws. Tighten and/or replace as needed.
- Inspect guards and shields for damage and to ensure that they are securely in place. Replace if damaged or missing.
- Check that the attachment is firmly attached and in safe operating condition.
- Check that handle and harness (if included) are adjusted for safe, comfortable operation. See Assembly Section for proper adjustment.

WARNING

Moving parts can amputate fingers or cause severe injuries. Keep hands, clothing and loose objects away from all openings.

- ◆ ALWAYS stop engine, disconnect spark plug, and make sure all moving parts have come to a complete stop before removing obstructions, clearing debris, or servicing unit.
- ◆ DO NOT start or operate unit unless all guards and protective covers are properly assembled to unit.
- ◆ NEVER reach into any opening while the engine is running. Moving parts may not be visible through openings.

WARNING

Periodically Check fuel system (fuel lines, vent, grommet, fuel tank, and fuel cap) for leaks especially if the unit is dropped. If damage or leaks are found, do not use unit, otherwise serious personal injury or property damage may occur. Have unit repaired by an authorized servicing dealer before using.

EMISSION CONTROL (EXHAUST & EVAPORATIVE)

CARB And EPA Emissions Control Information

The emission control system for the engine is EM (engine modification) and, if the second to last character of the Engine Family on the Emission Control Information label (sample below) is "B", "C", "K", or "T", the emission control system is EM and TWC (3-way catalyst). The fuel tank/fuel line emission control system is EVAP (evaporative emissions). Evaporative emissions for California models are only applicable to fuel tanks.



An Emission Control Label is located on the engine. (This is an **EXAMPLE ONLY**, information on label varies by engine FAMILY).

Product Emission Durability (Emission Compliance Period)



The 50 or 300 hour emission compliance period is the time span selected by the manufacturer certifying the engine emissions output meets applicable emissions regulations, provided that approved maintenance procedures are followed as listed in the Maintenance Section of this manual.

DESCRIPTION

PAS-225

Locate the safety decal(s) on your unit. Make sure the decal(s) is legible and that you understand and follow the instructions on it. If a decal cannot be read, a new one can be ordered from your ECHO dealer.

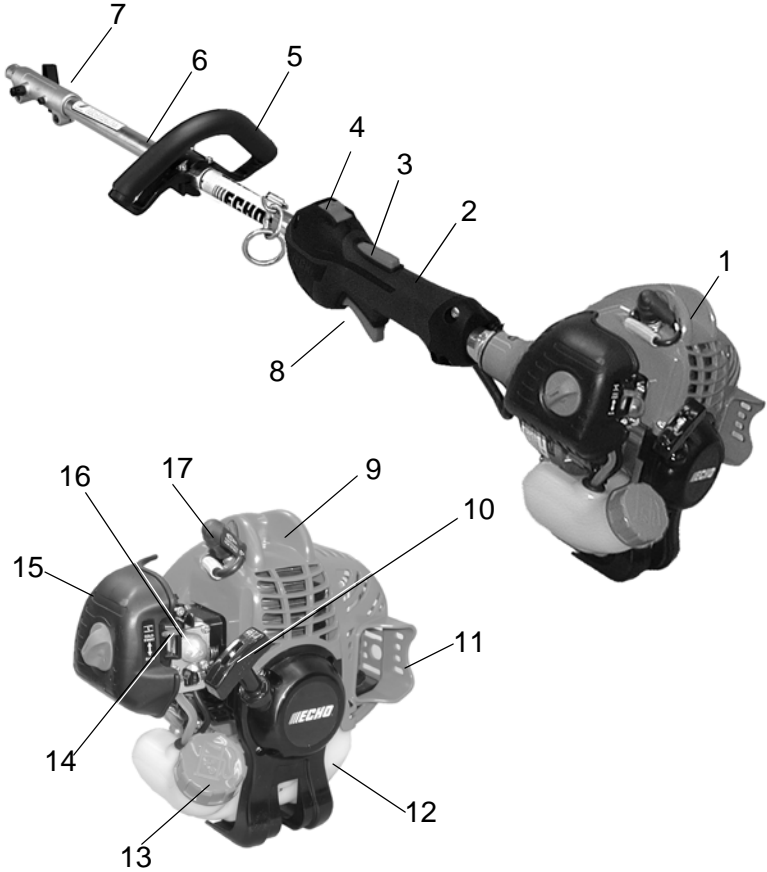

Hot Label



1. **POWER HEAD** - Includes the Engine, Clutch, Fuel System, Ignition System and Recoil Starter.
2. **THROTTLE HANDLE - FOR RIGHT HAND** - Contains Stop Switch, Throttle Lockout, and Throttle Trigger.
3. **THROTTLE TRIGGER LOCKOUT** - This lever must be held during starting. Operation of the throttle trigger is prevented unless throttle trigger lockout lever is engaged.
4. **STOP SWITCH** - "SLIDE SWITCH" mounted on top of the throttle handle. Move switch FORWARD to RUN, BACK to STOP.
5. **SUPPORT HANDLE - FOR LEFT HAND** - Grip for Left Hand.
6. **UPPER DRIVE SHAFT ASSEMBLY** - Includes the Throttle Handle, Support Handle, Upper Flexible Drive Cable, Drive Shaft Assembly Coupler, Harness Ring, and Power Head.
7. **DRIVE SHAFT COUPLER** - Includes Locator Pin and Clamping Knob.
8. **THROTTLE TRIGGER** - Spring loaded to return to idle when released. During acceleration, press trigger gradually for best operating technique.
9. **TOP GUARD** - Protects arm from the hot engine.
10. **RECOIL STARTER HANDLE** - Pull handle slowly until starter engages, then quickly and firmly. When engine starts, return handle slowly. DO NOT let handle snap back or damage to unit will occur.
11. **SPARK ARRESTOR MUFFLER OR SPARK ARRESTOR MUFFLER WITH CATALYST** - The muffler or catalytic muffler controls exhaust noise and emission. The spark arrestor screen prevents hot, glowing particles of carbon from leaving the muffler. Keep exhaust area clear of flammable debris.
12. **FUEL TANK** - Contains fuel and fuel filter.
13. **FUEL TANK CAP** - Covers and seals fuel tank opening.
14. **CHOKE** - The choke control is located at the rear of the air cleaner housing. Move choke lever to COLD START (👈) to close choke for cold start. Move choke lever to "RUN" (👆) position to open choke.
15. **AIR CLEANER** - Contains replaceable filter element.
16. **PURGE BULB** - Pumping purge bulb before starting engine draws fresh fuel from the fuel tank, purging air from the carburetor. Pump purge bulb until fuel is visible and flows freely in the clear fuel tank return line. Pump purge bulb an additional 4 or 5 times.
17. **SPARK PLUG** - Provides spark to ignite fuel mixture.

PAS-225 SB

Locate the safety decal(s) on your unit. Make sure the decal(s) is legible and that you understand and follow the instructions on it. If a decal cannot be read, a new one can be ordered from your ECHO dealer.

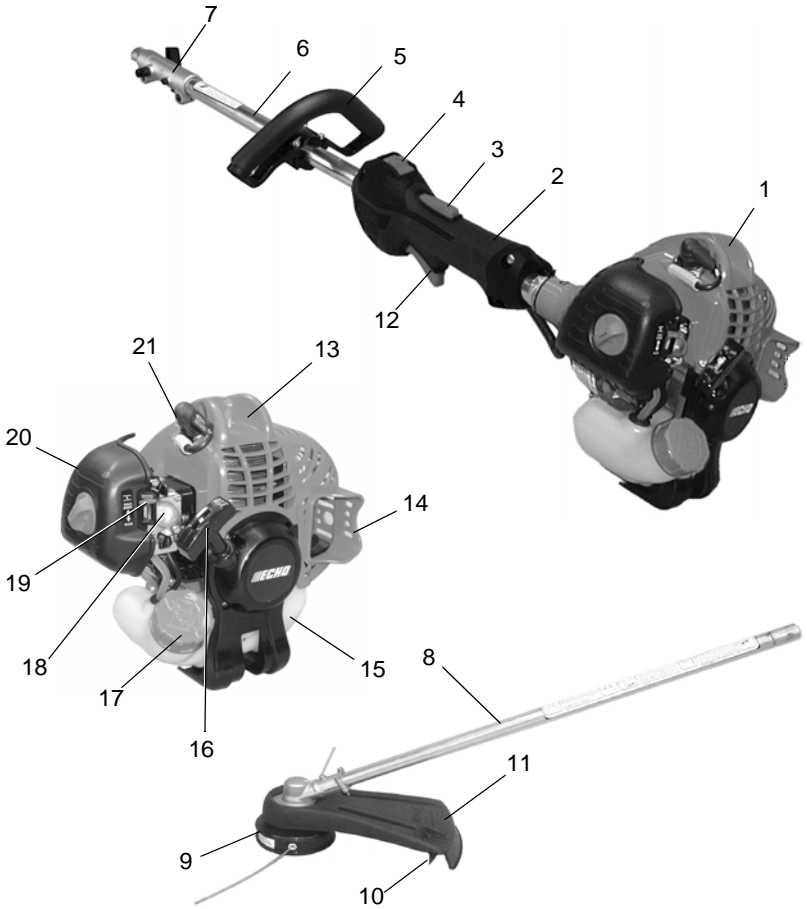

Shaft Label



Hot Label



1. **POWER HEAD** - Includes the Engine, Clutch, Fuel System, Ignition System and Recoil Starter.
2. **THROTTLE HANDLE - FOR RIGHT HAND** - Contains Stop Switch, Throttle Lockout, and Throttle Trigger.
3. **THROTTLE TRIGGER LOCKOUT** - This lever must be held during starting. Operation of the throttle trigger is prevented unless throttle trigger lockout lever is engaged.
4. **STOP SWITCH** - "SLIDE SWITCH" mounted on top of the throttle handle. Move switch FORWARD to RUN, BACK to STOP.
5. **SUPPORT HANDLE - FOR LEFT HAND** - The support handle must be assembled to the Upper Drive Shaft Assembly (some models) and must be positioned for proper cutting attitude and operator comfort.
6. **UPPER DRIVE SHAFT ASSEMBLY** - Includes the throttle handle, support handle, Upper Flexible Drive Cable, Drive Shaft Assembly Coupler and Power Head.
7. **DRIVE SHAFT COUPLER** - Includes Locator Pin and Clamping Knob.
8. **LOWER DRIVE SHAFT ASSEMBLY** - Includes the Debris Shield Assembly, Gear Housing Assembly, Lower Flexible Drive Cable, Cutting Attachment, and Safety Decal.
9. **NYLON CUTTING ATTACHMENT** - Contains replaceable nylon trimming line that advances when the trimmer head is tapped against the ground while the head is turning at normal operating speed.
10. **CUT-OFF KNIFE** - Automatically trims line to the correct length after head is tapped on the ground. If trimmer is operated without a cut-off knife the line will become too long, the engine will overheat and engine damage may occur.
11. **DEBRIS SHIELD with CUT-OFF KNIFE** - Required when unit is equipped with nylon line head. Do not operate unit without shield.
12. **THROTTLE TRIGGER** - Spring loaded to return to idle when released. During acceleration, press trigger gradually for best operating technique.
13. **TOP GUARD** - Protects arm from the hot engine.
14. **SPARK ARRESTOR MUFFLER OR SPARK ARRESTOR MUFFLER WITH CATALYST** - The muffler or catalytic muffler controls exhaust noise and emission. The spark arrestor screen prevents hot, glowing particles of carbon from leaving the muffler. Keep exhaust area clear of flammable debris.
15. **FUEL TANK** - Contains fuel and fuel filter.
16. **RECOIL STARTER HANDLE** - Pull handle slowly until starter engages, then quickly and firmly. When engine starts, return handle slowly. DO NOT let handle snap back or damage to unit will occur.

- 17. **FUEL TANK CAP** - Covers and seals fuel tank opening.
- 18. **PURGE BULB** - Pumping purge bulb before starting engine draws fresh fuel from the fuel tank, purging air from the carburetor. Pump purge bulb until fuel is visible and flows freely in the clear fuel tank return line. Pump purge bulb an additional 4 or 5 times.
- 19. **CHOKE** - The choke control is located at the rear of the air cleaner housing. Move choke lever to COLD START (←) to close choke for cold start. Move choke lever to "RUN" (↑) position to open choke.
- 20. **AIR CLEANER** - Contains replaceable filter element.
- 21. **SPARK PLUG** - Provides spark to ignite fuel mixture.

CONTENTS

The ECHO product you purchased has been factory pre-assembled for your convenience. Due to packaging restrictions, some assembly may be necessary.

After opening the carton, check for damage. Immediately notify your retailer or ECHO Dealer of damaged or missing parts. Use the contents list to check for missing parts.

- ___ 1 - Power Head w/ Upper Drive Shaft Assembly
 - ___ 1 - Lower Drive Shaft Assembly*
 - ___ 1 - Operator's Manual
 - ___ 1 - Safety Manual
 - ___ 1 - Warranty Statement
 - ___ 1 - Echo Power Blend X™ 2-Stroke Oil Sample
 - ___ 1 - Safety Glasses
 - ___ 1 - Storage Hook Assembly*
- *Included with PAS-225SB only

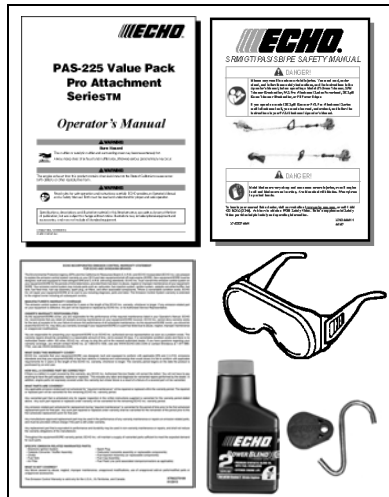

ASSEMBLY

Power Head Shaft/Lower Shaft Assembly

Parts Required: PAS Attachment



1. Set Power Head/Shaft Assembly on a level surface.
2. Pull locator pin (A) out, and turn counterclockwise $\frac{1}{4}$ turn to lock-out position.
3. Remove vinyl cap from attachment drive shaft.
4. Remove cardboard spacer, if necessary.
5. Carefully fit attachment drive shaft assembly into coupler (B) to decal assembly line (C), making sure that the inner lower drive shaft engages the square upper drive shaft socket.

Note: Lower bearing housing and head assembly must be in line with the engine.

6. Rotate locator pin (A) $\frac{1}{4}$ turn clockwise to engage lower shaft hole. Insure locator pin is fully engaged by twisting lower drive shaft. Locator pin should snap flush in coupler. Full engagement will prevent further shaft rotation.
7. Secure lower shaft assembly to coupler by tightening clamping knob (D).

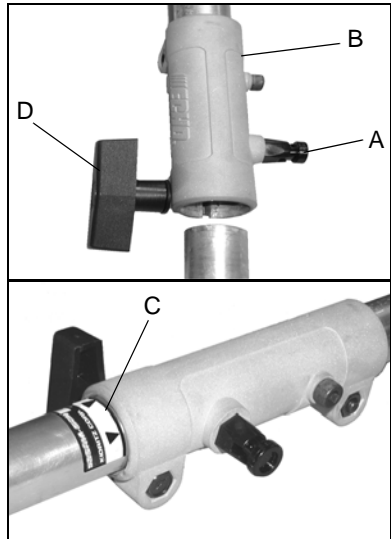

Support Handle Installation

Note: Label shows minimum spacing for support handle location.

1. If necessary, position support handle for comfortable operation and securely tighten screws.

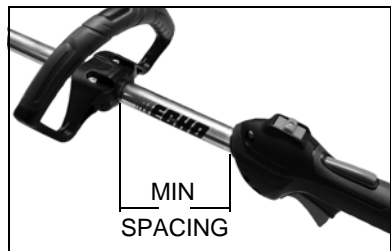

OPERATION

 **WARNING**

Moving parts can amputate fingers or cause severe injuries. Keep hands, clothing and loose objects away from all openings. Always stop engine, disconnect spark plug, and make sure all moving parts have come to a complete stop before removing obstructions, clearing debris, or servicing unit.

 **WARNING**

Engine exhaust IS HOT, and contains Carbon Monoxide (CO), a poison gas. Breathing CO can cause unconsciousness, serious injury, or death. Exhaust can cause serious burns. ALWAYS position unit so that exhaust is directed away from your face and body.

 **WARNING**

Operation of this equipment may create sparks that can start fires around dry vegetation. This unit is equipped with a spark arrestor to prevent discharge of hot particles from the engine. Metal cutters can also create sparks if the cutter strikes rocks, metal, or other hard objects. Contact local fire authorities for laws or regulations regarding fire prevention requirements.

Fuel **WARNING**

Diesel fuels and alternative fuels, such as E-15 (15% ethanol), E-85 (85% ethanol) or any fuels not meeting ECHO requirements are NOT approved for use in ECHO 2-stroke gasoline engines. Use of diesel or alternative fuels may cause performance problems, loss of power, overheating, fuel vapor lock, and unintended machine operation, including, but not limited to, improper clutch engagement. Diesel or alternative fuels may also cause premature deterioration of fuel lines, gaskets, carburetors and other engine components.

Fuel Requirements

Gasoline - Use 89 Octane [R+M/2] (mid grade or higher) gasoline known to be good quality. Gasoline may contain up to 10% Ethanol (grain alcohol) or 15% MTBE (methyl tertiary-butyl ether). Gasoline containing methanol (wood alcohol) is **NOT** approved. ECHO brand Power Fuel™ is 93 octane, ethanol-free fuel premixed with ECHO Red Armor® engine oil at 50:1 ratio. Use of ECHO Power Fuel™ is recommended to extend engine life in all air-cooled 2-stroke and 2/4-stroke hybrid engines.

Two Stroke Oil - A two-stroke engine oil meeting ISO-L-EGD (ISO/CD 13738) and J.A.S.O. FD Standards must be used. Echo brand premium Power Blend X™ Universal 2-Stroke Oil meets these standards. Engine problems due to inadequate lubrication caused by failure to use an ISO-L-EGD (ISO/CD 13738) and J.A.S.O. M345-FD certified oil, such as Echo premium Power Blend X™, will void the two-stroke engine warranty.

NOTICE

Echo premium Power Blend X™ Universal 2-Stroke Oil may be mixed at 50:1 ratio for application in all Echo engines sold in the past regardless of ratio specified in those manuals.

Handling Fuel

DANGER

Fuel is VERY flammable. Use extreme care when mixing, storing or handling, or serious personal injury may result.

- ◆ **Use an approved fuel container.**
- ◆ **DO NOT smoke near fuel.**
- ◆ **DO NOT allow flames or sparks near fuel.**
- ◆ **Fuel tanks/cans may be under pressure. Always loosen fuel caps slowly allowing pressure to equalize.**
- ◆ **NEVER refuel a unit when the engine is HOT or RUNNING!**
- ◆ **DO NOT fill fuel tanks indoors. ALWAYS fill fuel tanks outdoors over bare ground.**
- ◆ **DO NOT overfill fuel tank. Wipe up spills immediately.**
- ◆ **Securely tighten fuel tank cap and close fuel container after refueling.**
- ◆ **Inspect for fuel leakage. If fuel leakage is found, do not start or operate unit until leakage is repaired.**
- ◆ **Move at least 3 m (10 ft.) from refueling location before starting the engine.**

Mixing Instructions

1. Fill an approved fuel container with half of the required amount of gasoline.
2. Add the proper amount of 2-stroke oil to gasoline.
3. Close container and shake to mix oil with gasoline.
4. Add remaining gasoline, close fuel container, and remix.

Fuel to Oil Mix – 50:1 Ratio			
US		Metric	
Gas	Oil	Gas	Oil
Gallons	Oz.	Liter	CC.
1	2.6	5	100
2	5.2	10	200
5	13	25	500

NOTICE

Spilled fuel is a leading cause of hydrocarbon emissions. Some states may require the use of automatic fuel shut-off containers to reduce fuel spillage.

After use

- DO NOT store a unit with fuel in its tank. Leaks can occur. Return unused fuel to an approved fuel storage container.

Storage - Fuel storage laws vary by locality. Contact your local government for the laws affecting your area. As a precaution, store fuel in an approved, airtight container. Store in a well-ventilated, unoccupied building, away from sparks and flames.

**NOTICE**

Stored fuel ages. Do not mix more fuel than you expect to use in thirty (30) days, ninety (90) days when a fuel stabilizer is added.

NOTICE

Stored two-stroke fuel may separate. ALWAYS shake fuel container thoroughly before each use.

Operation With Blades

WARNING

Blade use DEMANDS specific Brush Cutter configuration. Operation without specified shield, barrier bar or U-handle, and harness can result in serious personal injury. Follow installation instructions.

PARTS REQUIRED FOR THESE BLADES:		
Pro Maxi-Cut Grass/Weed Blade	Rigid Plastic Tri-Cut Grass/Weed Blade	Metal Blade
Support Handle, w/ or w/o Barrier Bar	U-Handle or Support Handle w/Barrier Bar	U-Handle or Support Handle w/Barrier Bar
Shield w/cutoff knife	Shield w/cutoff knife	Shield w/o cutoff knife
Harness	Harness	Harness
Upper Plate & Flat Washer	Upper Plate & Glide Cup	Upper/Lower Blade Plates
Hex Nut	Hex Nut	Hex Nut
New Cotter Pin	New Cotter Pin	New Cotter Pin

WARNING

DO NOT INSTALL BLADES ON GT (CURVED SHAFT) MODEL TRIMMERS.

- Arbor Diameter of Upper Blade Plate must match arbor diameter of blades.
- A new cotter pin is required each time a blade is installed.
- Brush cutters over 7.5 kg (16.5 lbs.) dry weight (weight w/o fuel) require a double shoulder harness.

Note: The Barrier Bar is used to restrict rearward movement of the unit. The Barrier Bar is NOT A HANDLE and should not be gripped when using or carrying the unit.

Blade Selection

WARNING

*The type of Blade used **MUST** be matched to the type and size of material cut. An improper or dull blade can cause serious personal injury. Blades **MUST** be sharp. Dull blades increase the chance of kick-out and injury to yourself and bystanders.*

Plastic/Nylon Grass/Weed Blades may be used where ever the nylon line head is used. **DO NOT** use this blade for heavy weeds or brush!



8 Tooth Weed/Grass Blade is designed for grass, garden debris and thick weeds up to 19 mm (¾ in.) diameter. **DO NOT** use this blade for brush or heavy woody growth.

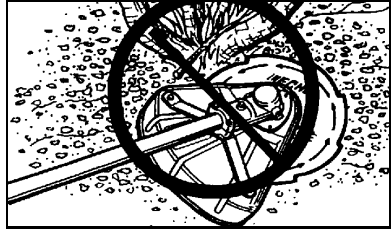

80 Tooth Brush Blade is designed for cutting brush and woody growth up to 13 mm (½ in.) diameter.

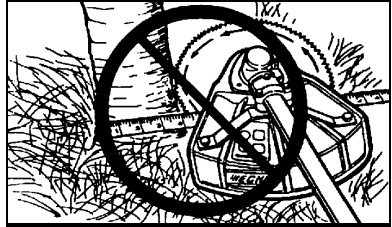

22 Tooth Clearing Blade is designed for dense thickets and saplings up to 64 mm (2½ in.) diameter.

Use Shoulder/Waist Harness Use of the Shoulder/Waist Harness is recommended for **ALL** Trimmer/Brush Cutter use, not just Blade operation. The Shoulder/Waist Harness when used in a trimming operation with nylon line head suspends the trimmer from the operator's shoulder and reduces operator fatigue.



During blade operation, the same fatigue reduction is achieved. Safety to the operator is also enhanced by reducing the possibility of blade contact with the operator's hands and feet by restricting trimmer movement.



Starting Cold Engine

WARNING

The attachment will operate immediately when the engine starts, and could result in possible serious injury. Keep movable parts of the attachment away from objects that could become entangled or thrown, and surfaces that could cause loss of control.

1. Stop Switch

Move stop switch button (A) forward, away from the STOP position.

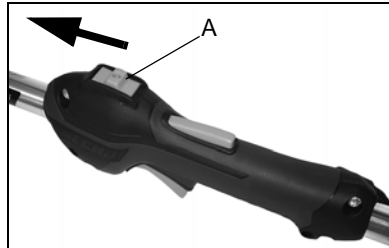

2. Choke

Move choke lever (B) to COLD START (|←|) position.



3. Purge Bulb

Pump purge bulb (C) until fuel is visible and flows freely in the clear fuel tank return line. Pump bulb an additional 4 or 5 times.

4. Recoil Starter

Lay the unit on a flat area and keep movable attachment parts clear of all obstacles. Firmly grasp throttle handle and throttle trigger lockout with left hand and fully depress throttle trigger to wide open position. Rapidly pull recoil starter handle/rope (D) until engine fires (or maximum five [5] pulls).

5. *Choke*

After engine fires (or 5 pulls), move choke (B) to the RUN (|+|) (open) position. Firmly grasp throttle handle and throttle trigger lockout with left hand and fully depress throttle trigger to wide open position. Pull starter handle/rope until engine starts and runs. Release throttle trigger and allow unit to warm up at idle for several minutes.

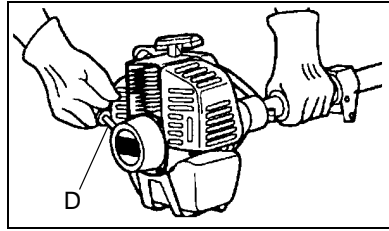

Note: If engine does not start with choke in “RUN” position after 5 pulls, repeat instructions 2 - 5.

6. *Throttle Trigger*

After engine warm-up, grip throttle handle and support handle. Depress the throttle trigger lockout, and gradually depress throttle trigger to increase engine RPM to operating speed.

Starting Warm Engine

The starting procedure is the same as Cold Start except DO NOT close the choke, and do not hold throttle trigger fully depressed.

WARNING

The attachment should not move at idle, otherwise serious personal injury may result.

Note: If attachment moves, readjust carburetor according to “Carburetor Adjustment” instructions in this manual or see your ECHO Dealer.

1. *Stop Switch*

Move stop switch button (A) forward away from the STOP position.

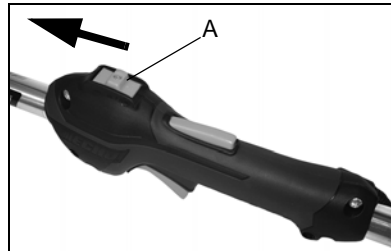

2. *Purge Bulb*

Pump purge bulb (C) until fuel is visible in the "Clear" fuel return line. Pump bulb an additional 4 or 5 times.

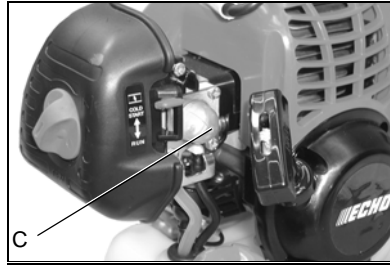
3. *Recoil Starter*

Lay the unit on a flat area and keep movable attachment parts clear of all obstacles. Firmly grip throttle handle and throttle trigger lockout with left hand. Rapidly pull recoil starter handle/rope (D) until engine fires.

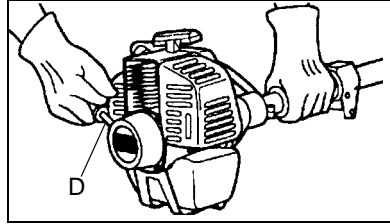

Note: If engine does not start after 5 pulls, use Cold Start Procedure.

Stopping Engine1. *Throttle*

Release throttle trigger and allow engine to return to idle before shutting off engine.

2. *Stop Switch*

Move stop switch button (A) backward to STOP position.

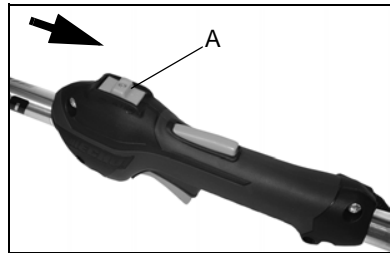

! WARNING

If engine does not stop when stop switch is moved to STOP position, close choke - COLD START position - to stall engine. Have your ECHO dealer repair stop switch before using unit again.

MAINTENANCE

WARNING

Moving parts can amputate fingers or cause severe injuries. Keep hands, clothing and loose objects away from all openings. Always stop engine, disconnect spark plug, and make sure all moving parts have come to a complete stop before removing obstructions, clearing debris, or servicing unit. Allow unit to cool before performing service. Wear gloves to protect hands from sharp edges and hot surfaces.

Your ECHO unit is designed to provide many hours of trouble free service. Regular scheduled maintenance will help your unit achieve that goal. If you are unsure or are not equipped with the necessary tools, we recommend that you take your unit to an ECHO Servicing Dealer for maintenance. To help you decide whether you want to DO-IT-YOURSELF or have the ECHO Dealer do it, each maintenance task has been graded. If the task is not listed, see your ECHO Dealer for repairs.

Skill Levels

Level 1 = Easy to do. Common tools may be required.

Level 2 = Moderate difficulty. Some specialized tools may be required.

Click [HERE](#) or go to <http://www.echo-usa.com/products/maintenance-kit> for information on Maintenance Kits.

Maintenance Intervals

COMPONENT/SYSTEM	MAINTENANCE PROCEDURE	REQ'D SKILL LEVEL
Daily or Before Use		
Air Filter	Inspect/Clean *	1
Choke Shutter	Inspect/Clean *	1
Fuel System	Inspect (3)	1
Cooling System	Inspect/Clean	2
Recoil Starter Rope	Inspect/Clean *	1
Screws/Nuts/Bolts	Inspect/Tighten/Replace *	1
Every Refuel		
Fuel System	Inspect (3)	1
3 Months		

COMPONENT/SYSTEM	MAINTENANCE PROCEDURE	REQ'D SKILL LEVEL
Air Filter	Replace *	1
Fuel Filter	Inspect *	1
Fuel Cap Gasket	Inspect *	1
Spark Plug	Inspect/Clean/Replace *	1
Muffler Spark Arrestor	Inspect/Clean/Replace *	2
Cylinder Exhaust Port	Inspect/Clean/Decarbon	2
Drive Shaft (Flex Cable Models)	Grease (1)	2
Gear Housing	Grease (2)	2
Yearly		
Fuel Filter	Inspect/Replace *	1
Fuel Cap Gasket	Replace *	1

IMPORTANT NOTE - Time intervals shown are maximum. Actual use and your experience will determine the frequency of required maintenance.

MAINTENANCE PROCEDURE NOTES:

- (1) Apply lithium based grease every 25 hours of use.
- (2) Apply lithium based grease every 50 hours of use.
- (3) Low evaporative fuel tanks DO NOT require regular maintenance to maintain emission integrity.

* Replacement is recommended based on the finding of damage or wear during inspection.

Air Filter

Level 1.

Parts Required: Tune-Up Kit

1. Close choke (COLD START [↔] position). This prevents dirt from entering the carburetor throat when the air filter is removed. Brush accumulated dirt from air cleaner area.

2. Remove air filter cover. Brush dirt from inside cover.
3. Replace filter if it is damaged, fuel soaked, very dirty, or the rubber sealing edges are deformed.
 - Lightly brush debris from filter.
 - Soak heavily soiled filters in water/detergent solution to loosen dirt, then brush lightly.
 - Rinse with clean water and allow to dry completely before reuse.
4. Install air filter in air filter case.
5. Install air filter cover.

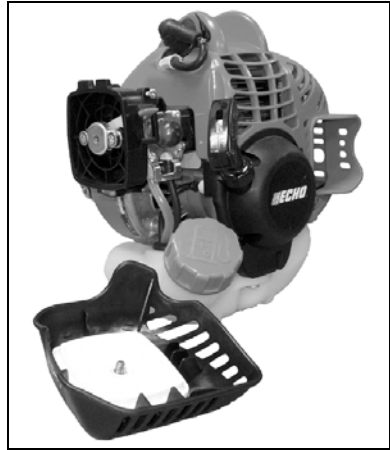

Fuel Filter

Level 1.

Parts Required: Tune-Up Kit

! DANGER

Fuel is VERY flammable. Use extreme care when mixing, storing or handling, or serious personal injury may result.

1. Use a clean rag to remove loose dirt from around fuel cap and empty fuel tank.
2. Pull the fuel filter from the fuel tank.



NOTICE

Do not damage fuel line while removing fuel filter from tank.

3. Remove the filter from the line and install the new filter.

Note: Federal EPA regulations require all model year 2012 and later gasoline powered engines produced for sale in the United States to be equipped with a special low permeation fuel supply hose between the carburetor and fuel tank. When servicing model year 2012 and later equipment, only fuel supply hoses certified by EPA can be used to replace the original equipment supply hose. Fines up to \$37,500 may be enforced for using an un-certified replacement part.

Spark Plug

Level 2.

Parts Required: Tune-Up Kit

NOTICE

Use only NGK BPM-8Y spark plug (BPMR-8Y in Canada) otherwise severe engine damage may occur.

1. Remove spark plug and check for fouling, worn and rounded center electrode.
2. Clean the plug or replace with a new one. **DO NOT** sand blast to clean. Remaining sand will damage engine.
3. Adjust spark plug gap by bending outer electrode.
4. Tighten spark plug to 150-170 kgf•cm (130-150 in•lb).

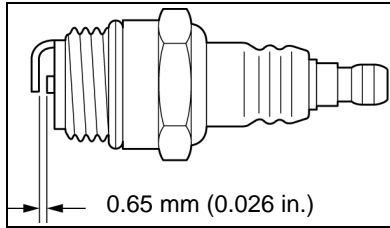

Cooling System

Level 2.

Parts Required: None if you are careful.

NOTICE

To maintain proper engine operating temperatures, cooling air must pass freely through the cylinder fin area. This flow of air carries combustion heat away from the engine.

Overheating and engine seizure can occur when:

- Air intakes are blocked, preventing cooling air from reaching the cylinder.
- Dust and grass build up on the outside of the cylinder. This build up insulates the engine and prevents the heat from leaving.

Removal of cooling passage blockages or cleaning of cooling fins is considered "Normal Maintenance." Any failure attributed to lack of maintenance is not warranted.

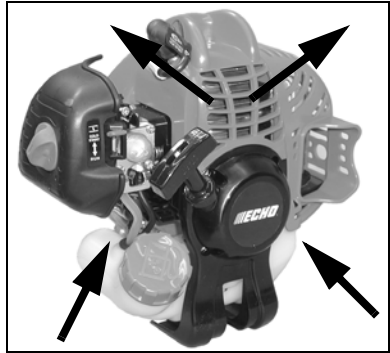

1. Remove spark plug lead.
2. Remove air cleaner cover (A).
3. Remove engine cover (B).

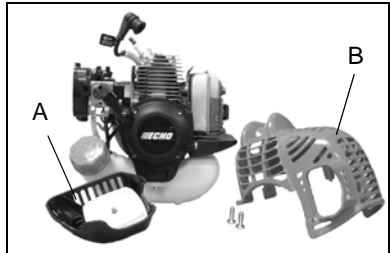

NOTICE

DO NOT use a metal scraper to remove dirt from the cylinder fins.

4. Use a brush to remove dirt from the cylinder fins.
5. Remove ignition wires from clip for cleaning.



6. Remove grass and leaves from the grid between the recoil starter and fuel tank.
7. Assemble components in reverse order.

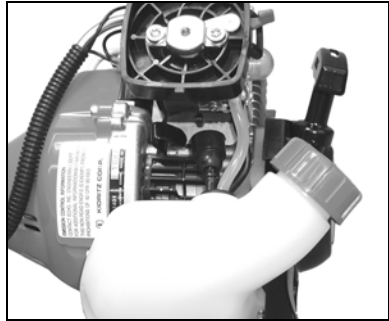

Exhaust System

Spark Arrestor Screen

Level 2.

Parts Required: Spark Arrestor Screen, Gasket

1. Remove spark plug lead.
2. Remove engine cover (B).
3. Place piston at Top Dead Center (TDC) to prevent carbon/dirt from entering cylinder.

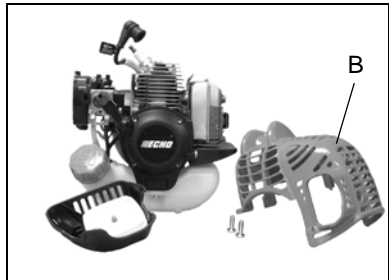

4. Remove spark arrestor screen cover (C), gaskets (D), (E), and screen (F), from muffler body.
5. Clean carbon deposits from muffler components.

Note: When cleaning carbon deposit, be careful not to damage the catalytic element inside muffler.

6. Replace screen if it is cracked, plugged, or has holes burned through.
7. Assemble components in reverse order.

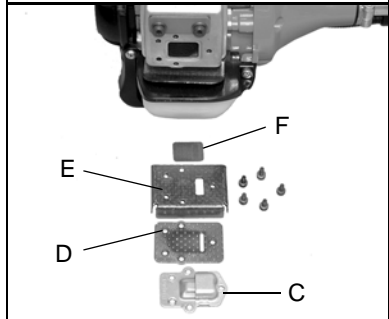

Exhaust Port Cleaning

Level 2.

Parts Required: As needed: Heat Shield

1. Remove spark plug lead from spark plug, and remove engine cover.
2. Place piston at top dead center. Remove muffler (A) and heat shield (B).
3. Use a wood or plastic scraping tool to clean deposits from cylinder exhaust port.

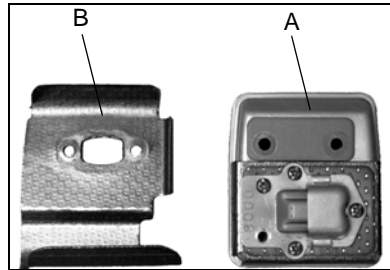

NOTICE

Never use a metal tool to scrape carbon from the exhaust port. Do not scratch the cylinder or piston when cleaning the exhaust port. Do not allow carbon particles to enter the cylinder.

4. Inspect heat shield, and replace if damaged.
5. Install heat shield and muffler.
6. Tighten muffler mounting bolts (or nuts) to 90-110 kgf•cm (80-95 in•lbf).
7. Install engine cover and attach spark plug lead.
8. Start engine, and warm to operating temperature.
9. Stop engine, and re-tighten mounting bolts (or nuts) to specifications.

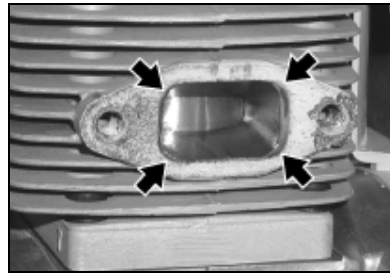

Carburetor Adjustment

Level 2.

Engine Break-In

New engines must be operated a minimum duration of two tanks of fuel break-in before carburetor adjustments can be made. During the break-in period your engine performance will increase and exhaust emissions will stabilize. Idle speed can be adjusted as required.

High Altitude Operation

This engine has been factory adjusted to maintain satisfactory starting, emission, and durability performance up to 1,100 feet above sea level (ASL) (96.0 kPa). To maintain proper engine operation and emission compliance above 1,100 feet ASL the carburetor may need to be adjusted by an authorized ECHO service dealer.

NOTICE

If the engine is adjusted for operation above 1,100 feet ASL, the carburetor must be re-adjusted when operating the engine below 1,100 feet ASL, otherwise severe engine damage may result.

Parts Required: None

Note: Every unit is run at the factory and the carburetor is set in compliance with emission regulations. Carburetor adjustments, other than idle speed, must be performed by an authorized ECHO dealer.

1. Check idle speed and reset if necessary. If a tachometer is available, idle speed screw (A) should be set to the specifications found on "Specifications" page of this manual. Turn idle screw (A) clockwise to increase idle speed; counterclockwise to decrease idle speed.

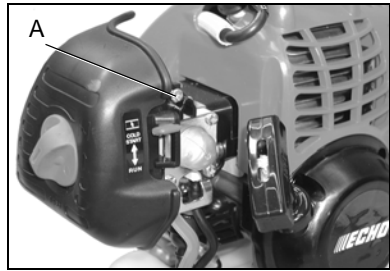

WARNING

When carburetor adjustment is completed, the cutting attachment should not move at idle, otherwise serious personal injury may result.

Lubrication

Level 1.

Parts Required: Lithium Based Grease.

Drive Shaft Upper

1. Loosen clamping knob (A).
2. Pull locator pin (B) and rotate ¼ turn counterclockwise to lockout position.
3. Remove attachment.
4. Remove coupler from upper drive shaft assembly by loosening clamping screw (C) and removing set screw (D).

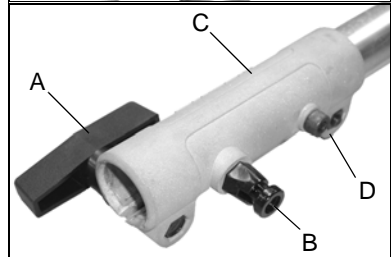
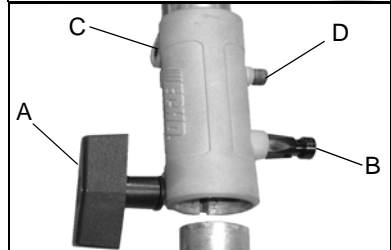

5. Remove upper flex cable (F), wipe clean, and apply a thin coating of 15ml (½ oz.) of grease.
6. Install cable. Make sure that the flex cable fully engages into the clutch square drive socket.
7. Slide coupler on upper drive shaft until fully seated, and align set screw hole in coupling with hole in upper drive shaft.
8. Install and tighten set screw (D), and tighten clamping screw (C).

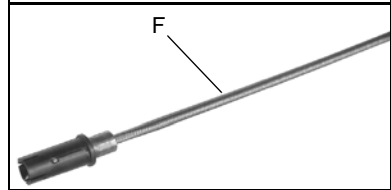

PAS-225 SB Only:

Lubrication

Level 1.

Parts Required: Lithium Base Grease.

Gear Housing

1. Clean all loose debris from gear case.
2. Remove plug (A) and check level of grease.
3. Add grease if necessary. DO NOT over-fill.
4. Install plug (A).

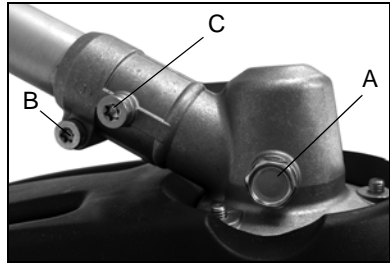

Drive Shaft (Lower)

1. Loosen screw (B) and remove locating screw (C). Pull gear case and shield from drive shaft housing.
2. Pull flexible cable from the drive shaft housing, wipe clean and re-coat with a thin coating [15 ml (½ oz.)] of grease.
3. Slide the flexible cable back in the drive housing. DO NOT get dirt on the flex cable.
4. Install the gear housing and shield assembly.

Nylon Line Head Disassembly Instructions

Note: For normal use, Speed Feed® head disassembly is not necessary. However, if circumstances require disassembly, follow these instructions.

1. Press top of locking tabs (A) on both sides of Speed Feed® head to release cover (B) from eyelet carrier (C).
2. Remove cover from eyelet carrier.

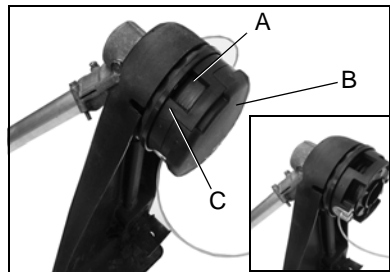

Nylon Line Replacement

⚠ CAUTION

Wear Gloves or personal injury may result:

- ◆ *Cutoff knife is sharp.*

◆ Gearcase and surrounding area may be hot.



1. Cut one piece of line to recommended length.
2.0 mm (.080) diam. – 6 m (20 ft.)
2.4 mm (.095) diam. – 6 m (20 ft.)
2. Align arrows on top of knob with openings in eyelets.
3. Insert one end of trimmer line into an eyelet, and push line equal distance through trimmer head.
4. Hold trimmer head while turning knob clockwise to wind line onto spool until about 13 cm (5 in.) of each line remains exposed.

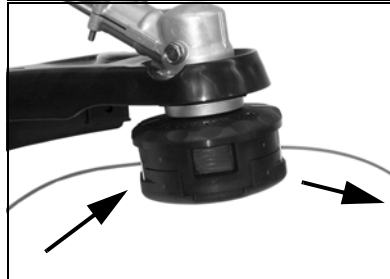
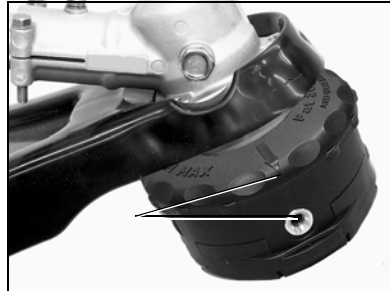

Trimmer head is now fully loaded and ready for operation.

NOTICE

When the wear indicators located at the bottom of the Speed-Feed® head are worn smooth, or if holes appear, replacement of the cover or the entire Speed-Feed® head is required.



Sharpening Metal Blades

Several styles of metal blades are approved for use on the Brush Cutter. The 8-tooth blade can be sharpened during normal maintenance. The clearing blade and 80 tooth blade require professional service.

Before sharpening, CLOSELY inspect blade for cracks (look at the bottom of each tooth and the center mounting hole closely), missing teeth and bending. If ANY of these problems are discovered, replace the blade.

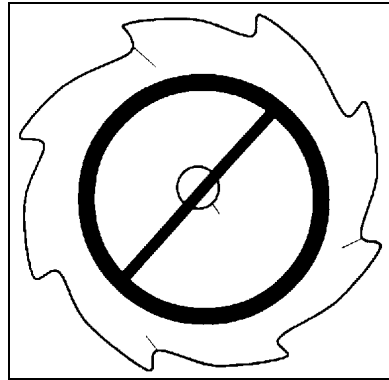

When sharpening a blade, always remove the same amount of materials from each tooth to maintain balance. A blade that is not balanced will cause unsafe handling due to vibration and can result in blade failure.

1. File each tooth at a 30 degree angle a specific number of times, e.g., 4 strokes per tooth. Work your way around the blade until all teeth are sharp.
2. DO NOT file the 'gullet' (radius) of the tooth with the flat file. The radius must remain. A sharp corner will lead to a crack and blade failure.

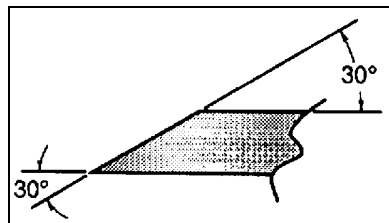

NOTICE

If an electric grinder is used, use care not to overheat teeth, do not allow tips/tooth to glow red or turn blue. DO NOT place blade in cooling water. This will change the temper of the blade and could result in blade failure.

- After sharpening teeth, check each tooth radius for evidence of a square (sharp) corner. Use the round (rat tail) file to renew the radius.

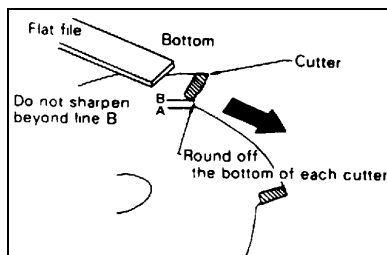

TROUBLESHOOTING

ENGINE PROBLEM TROUBLESHOOTING CHART				
Problem	Check	Status	Cause	Remedy
Engine cranks - starts hard/ doesn't start	Fuel at carburetor	No fuel at carburetor	Fuel strainer clogged - Fuel line clogged - Carburetor	Clean or replace - See your Echo dealer
	Fuel at cylinder	No fuel at cylinder	Carburetor	See your Echo dealer
		Muffler wet with fuel	Fuel Mixture too rich	OPEN choke - Clean/replace air filter - Adjust carburetor - See your Echo dealer
	Spark at end of plug wire	No spark	Stop switch OFF - Electrical problem - Interlock switch	Turn switch to ON - See your Echo dealer
Spark at plug	No spark	Spark gap incorrect - Covered with carbon - Fouled with fuel - Plug defective	Adjust to 0.65mm (0.026 in.) - Clean or replace plug	

ENGINE PROBLEM TROUBLESHOOTING CHART

Problem	Check	Status	Cause	Remedy
Engine runs, but dies or does not accelerate properly	Air filter	Air filter dirty	Normal wear	Clean or replace
	Fuel filter	Fuel filter dirty	Contaminants/residues in fuel	Replace
	Fuel vent	Fuel vent plugged	Contaminants/residues in fuel	Clean or replace
	Spark Plug	Plug dirty/worn	Normal wear	Clean and adjust or replace
	Carburetor	Improper adjustment	Vibration	Adjust
	Cooling System	Cooling system dirty/plugged	Extended operation in dirty/dusty locations	Clean
	Spark Arrestor Screen	Spark arrestor screen plugged	Normal wear	Replace
Engine does not crank	N/A	N/A	Internal engine problem	See your Echo dealer

DANGER

Fuel vapors are extremely flammable and may cause fire and/or explosion. Never test for ignition spark by grounding spark plug near cylinder plug hole, otherwise serious personal injury may result.

STORAGE

WARNING

During operation the muffler or catalytic muffler and surrounding cover become hot. Always keep exhaust area clear of flammable debris during transportation or when storing, otherwise serious property damage or personal injury may result.

Long Term Storage (Over 30 Days)

Do not store your unit for a prolonged period of time (30 days or longer) without performing protective storage maintenance which includes the following:

1. Store unit in a dry, dust free place, out of the reach of children.

DANGER

Do not store in enclosure where fuel fumes may accumulate or reach an open flame or spark.

2. Place the stop switch in the "OFF" position.
3. Remove accumulation of grease, oil, dirt and debris from exterior of unit.
4. Perform all periodic lubrication and services that are required.
5. Tighten all the screws and nuts.
6. Drain fuel tank completely. Press purge bulb 6-7 times to remove remaining fuel from carburetor then drain the tank again. Close choke, start and run the engine until it stops due to lack of fuel.
7. Allow engine to cool then remove the spark plug and pour 7 cc (¼ oz.) of fresh, clean, two-stroke engine oil into the cylinder through the spark plug hole.
8. Pull the recoil starter handle 2-3 times to distribute the oil inside the engine.
9. Observe the piston location through the spark plug hole. Pull the recoil handle slowly until the piston reaches the top of its travel and leave it there.
10. Install the spark plug (do not connect ignition cable).

PAS-225 SB Only:

Storage Hook Installation

1. Insert small end of hook into locating hole on attachment shaft.
2. Slide plastic cap onto end of attachment shaft.

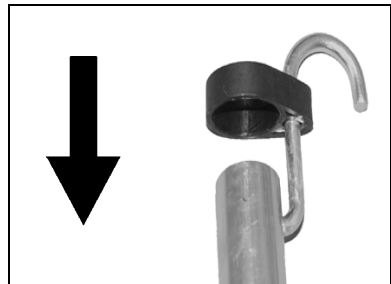

SPECIFICATIONS

MODEL	PAS-225 SB
Length	1798 mm (70.7 in.)
Width	246 mm (9.7 in.)
Height	328 mm (12.9in.)
Weight (dry)	5.4 kg (11.9 lb.)
Engine Type	Air cooled, two-stroke, single cylinder gasoline engine
Bore	32.2 mm (1.27 in.)
Stroke	26.0 mm (1.02 in.)
Displacement	21.2 cc (1.29 cu. in.)
Exhaust	Spark arrestor muffler or spark arrestor muffler with catalyst
Carburetor	Diaphragm w/purge pump
Ignition System	Flywheel magneto, capacitor discharge ignition type
Spark Plug	NGK BPMR-8Y (Gap 0.65 mm [0.026 in.]
Fuel	Mixed (Gasoline and Two-stroke Oil)
Fuel/Oil Ratio	50:1 Power Blend X™ or Echo Red Armor® ISO-L-EGD (ISO/CD 13738) and J.A.S.O. M345- FD, two-stroke, air-cooled engine oil.
Gasoline	Use 89 Octane unleaded. Do not use fuel containing methyl alcohol, more than 10% ethyl alcohol or 15% MTBE. Do not use alternative fuels such as E-15 or E-85.
Oil	Power Blend X™ or Echo Red Armor® Premium Universal 2-Stroke Oil
Fuel Tank Capacity	0.44 L (14.9 US fl. oz.)
Starter System	Automatic Rewind Starter
Clutch	Centrifugal Type
Drive Shaft (upper & lower)	6.35 mm (¼ in.) flexible shaft
Rotating Direction	Counterclockwise; viewed from top
Trimmer Attachment	Speed Feed® Nylon line head, Line capacity 6.0 m (20 ft.)
Handles	Front - Support, Rear Handle (w/rubber)
Shoulder Harness	Optional
Idle Speed	3,000 RPM
Clutch Engagement Speed	3,850 RPM
Wide Open Throttle Speed (W.O.T.)	10,000 RPM

MODEL	PAS-225
Length	1010 mm (39.7 in.)
Width	246 mm (9.7 in.)
Height	235 mm (9.2 in.)
Weight (dry)	3.75 kg (8.2 lb.)
Engine Type	Air cooled, two-stroke, single cylinder gasoline engine
Bore	32.2 mm (1.27 in.)
Stroke	26.0 mm (1.02 in.)
Displacement	21.2 cc (1.29 cu. in.)
Exhaust	Spark arrestor muffler or spark arrestor muffler with catalyst
Carburetor	Diaphragm w/purge pump
Ignition System	Flywheel magneto, capacitor discharge ignition type
Spark Plug	NGK BPMR-8Y (Gap 0.65 mm (0.026 in.))
Fuel	Mixed (Gasoline and Two-stroke Oil)
Fuel/Oil Ratio	50:1 Power Blend X™ or ECHO Red Armor® ISO-L-EGD (ISO/CD 13738) and J.A.S.O. M345- FD, two-stroke, air-cooled engine oil.
Gasoline	Use 89 Octane unleaded. Do not use fuel containing methyl alcohol, more than 10% ethyl alcohol or 15% MTBE. Do not use alternative fuels such as E-15 or E-85.
Oil	Power Blend X™ or ECHO Red Armor® Premium Universal 2-Stroke Oil
Fuel Tank Capacity	0.44 lit. (14.9 US fl. oz.)
Starter System	Automatic Rewind Starter
Clutch	Centrifugal Type
Drive Shaft (upper & lower)	6.35 mm (¼ in.) flexible shaft
Rotating Direction	Counter Clockwise; viewed from top
Handle	Front - loop, Rear handle (w/o rubber)
Shoulder Harness	Optional
Idle Speed	3,000 RPM
Clutch Engagement Speed	3,850 RPM
Wide Open Throttle Speed (W.O.T.)	10,000 RPM

ECHO Optional Attachments

WARNING

Use only ECHO attachments for these models. Serious injury may result from the use of non ECHO attachment combinations. Read and comply with all safety instructions listed in this manual and attachment manual.

ECHO, INC. will not be responsible for the failure of cutting devices, attachments or accessories which have not been tested and approved by ECHO for use with these units.

RECOMMENDED OPTIONAL ATTACHMENTS

Articulating Hedge Trimmer	99944200590
Articulating Hedge Trimmer	99944200595
Brush Cutter	99944200600
Curved Shaft Edger	99944200470
Hedge Trimmer	99944200480
Hedge Trimmer	99944200485
Power Blower	99944200490
Tiller/Cultivator	99944200510
Tiller/Cultivator	99944200513
Power Pruner™	99944200530
Power Pruner™	99944200532
Speed-Feed® Trimmer	99944200540
Rapid Loader™ Trimmer	99944200610
Rapid Loader™ Curved Shaft Trimmer	99944200615
Pro-Torque Trimmer	99944200545
3 Foot Extension*	99944200535

* For use with: Articulating Hedge Trimmer, Hedge Trimmer, and Power Pruner™ Attachments ONLY.

Notes

PRODUCT REGISTRATION

Thank you for choosing ECHO Power Equipment

Please go to <http://www.echo-usa.com/Warranty/Register-Your-ECHO> to register your new product on-line. It's **FAST** and **EASY!** NOTE: your information will never be sold or misused by ECHO, Inc. Registering your purchase enables us to contact you in the unlikely event of a service update or product recall, and verifies your ownership for warranty consideration.

If you do not have access to the Internet, you can complete the form below and mail to:

ECHO Inc., Product Registration, PO Box 1139, Lake Zurich IL 60047.



PRODUCT REGISTRATION CARD : TARJETA DE REGISTRO : CARTE D'ENREGISTREMENT DU PRODUIT

ONLINE OPTION: Register online and save a stamp! You will be alerted of product updates and/or be sent new ECHO product information and special offers. Simply go to: www.echo-usa.com

OPCIÓN POR INTERNET: Regístrese en la página web y ahorre una estampilla! Le alertarán sobre actualizaciones del producto y/o se le enviara información sobre los nuevos productos ECHO y las ofertas especiales. Simplemente visite: www.echo-usa.com

OPTION EN LIGNE: Enregistrer en ligne et épargner un timbre! Vous serez informé sur les nouveaux produits ECHO et les offres spéciales. Simplement visitez le: www.echo-usa.com

Please Print : Por Favor Escriba con Letra De Molde : En Lettre Carré S.V.P.

Confidential: Information provided will not be shared or sold

Purchaser's Name : Nombre del Comprador : Nom de l'acheteur	
Address : Dirección : Adresse	
City : Ciudad : Ville	State - Estado : Zip Code - Código Postal : Code Postal Province
E-Mail Address : Dirección De Correo Electrónico : Courrier Électronique	
Phone Number : Número De Teléfono : Téléphone	Date of Purchase : Fecha de la Compra : Date de l'achat
Where Purchased : Nombre del Almacén donde fue Comprado : Lieu d'achat	
Model Number : Numero del Modelo : No. de modèle	Serial Number : Numero de Serie : No. de série

Primary use of tool: Professional Homeowner Rental/Equip.
 Uso primario de la herramienta: Profesional Dueño de casa Alquiler
 Usage principal : Professionnel Résidentiel Location
 Do you wish to receive periodic ECHO product information and special offers by e-mail? Yes No
 ¿Desea usted recibir información periódica y ofertas especiales por correo electrónico sobre el producto ECHO? Yes No
 Souhaitez-vous recevoir périodiquement de l'information sur les produits ECHO et les offres spéciales par courrier électronique ? Oui Non

Did you visit the ECHO website before purchasing your product?
 Yes No
 Visité usted la página web ECHO antes de comprar su producto?
 Si No
 Avez-vous visité le site d'ECHO avant de procurer votre produit?
 Oui Non

What factor(s) most influenced your purchase?
 Performance Price Dealer
 Reliability Prior Experience Quality Warranty
 Friend/Family Brand Warrantly
 ¿Qué factor(es) influenció más en su compra?
 Funcionamiento Precio Distribuidor
 Confiabilidad Experiencia Anterior Calidad Garantía
 Amigo/Familia Marca Garantía
 Quel facteur (facteurs) vous a influencé le plus?
 Performance Prix Marchand
 Fiabilité Expérience Qualité
 Ami/Famille Marque Garantie

Registering your purchase enables us to contact you in the unlikely event of a service update or product recall and verifies your purchase. En registrar su compra, nos permite contactarlo en caso de un servicio de actualización o un llamado de atención de producto. El registro de su compra también verifica su compra.
 L'enregistrement de votre achat nous permettra de vous contacter dans le cas improbable de modifications des instructions d'entretien ou de rappel du produit et vérifier que vous êtes le propriétaire en cas de vol ou de perte.

ECHO INC., 400 Oakwood Rd., Lake Zurich, IL 60047
 1.800.432.ECHO WWW.ECHOUSA.COM

X7572270206 02-2012



Notes

Notes

S86813001001/S86813999999
T45013001001/T45013999999
T85813001001/T85813999999
S06400369501/S06400999999



ECHO, INCORPORATED
400 Oakwood Road
Lake Zurich, IL 60047
www.echo-usa.com