

WR & W SERIES

TRUCK AUGERS





It's not an ordinary auger... it's a Westfield

Since 1951, AGI Westfield has developed and refined the best grain augers available. We've learned that farmers want affordable, simple, straightforward designs for labor saving performance and dependability. Through a commitment to farm proven designs and innovation, AGI Westfield has earned a solid reputation for superior quality products. We take pride in developing the grain auger industry in order to improve the profitability and lifestyle of farmers today. Our grain augers are built with the best materials, components and features to provide value and performance you can count on. This is our promise and the reason why we're the industry leader.

AGI Westfield's WR & W Series is better by design, featuring Wear Edge Technology™ on critical wear points to extend the life of the flighting and powder coat paint for a strong durable finish. With more features and options than anyone else, the WR & W can be customized to suit any situation. This Series is available in 6" and 13" diameters, lengths from 26' to 71' and capacities up to 7,800 BPH.

FEATURES

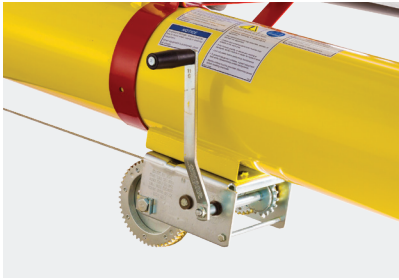

Winch

Hand winch with automatic brake is sized and geared to match the auger. The strong ¼" galvanized aircraft type cable can handle up to 7,000 lbs. of pressure.

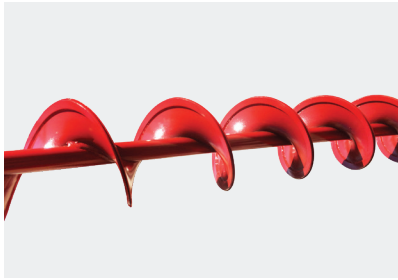

Flighting

Wear Edge Technology™ is added to the flighting. This means flighting is mounted and stretched on the flight shaft with hydraulic power and then welded in place for smoother running and longer life. All stretched and welded flight connections are timed for smooth grain flow.



Rollertrack Shoe

A roll-formed track under the auger tube provides excellent rigid support. Augers 46' and up have heavy-duty cable trussing for extra support and positive tube alignment.



Driveshaft Bearings

Driveshaft bearings constructed of durable oil-impregnated hard-wood, for long, quiet operation can be easily replaced if needed with no disassembly of driveshaft. Bearing brackets are factory jig-welded for precise alignment.



Gear Boxes

Gear boxes have forged steel gears with tapered roller bearings running in oil for years of dependable service and can be flipped for right or left hand PTO drive.

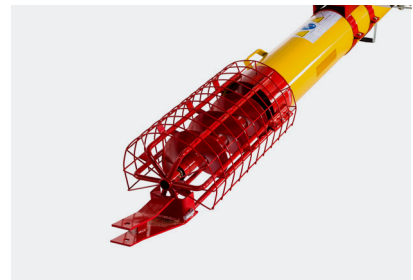

Intake

The shielded auger intake has a long, one-pin, quick-remove clevis that is easily replaced. Intake flight has welded Wear Edge™ for long life with special low pitch for proven added capacity. Greaseable bushing centers flight reducing vibration and wear.

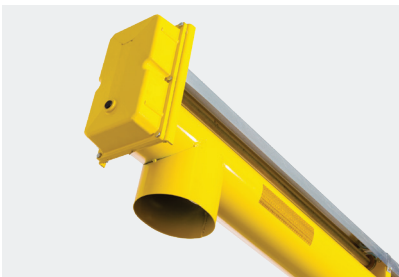

Lubricated Upper Drive

Heavy-duty hardened steel sprockets and high speed roller chain are sized to match auger length and diameter. Lubricated upper drive extends the life of sprockets and drive chain. Standard on all models.



Undercarriage

Undercarriages of heavy steel tubing are designed for each specific auger length for better balance and stability. Added cross bracing is used on larger models. Upper lift arms sit back from the axle and quickly tuck away for excellent bin eave clearance. Wide axles provide added stability. High speed wheels with cast iron hubs and tapered roller bearings are standard.

Drive Options

MD

Motor Drive

The engine mounts crosswise for easy starting from the side of the auger. The motor mount (for either gas engine or electric motor) is self-leveling at all auger positions keeping the motor at the correct working angle. Double belt drive with adjustable tension provides better traction and can be easily replaced. The motor drive does not have any gear boxes, so there are less moving parts. This means less time and money are spent on maintenance and repairs.



EMD

Electric Motor Drive

The electric motor is available for all models. The motor mounts firmly to the gear box and auger tube, keeping it in place and preventing damage. A double or triple belt drive (depending on model), provides better traction. Positive belt tension can be achieved by using the threaded adjustment, ensuring the auger is performing at maximum capacity.

W 13 available in this drive option



PTO-SD

PTO Shaft Drive

The gear box is connected directly to the drive shaft and offers the convenience and flexibility of using it for left or right hand drive. The PTO-SD comes with a non-separable 60" PTO driveline that extends to 80" and includes a driveline transport saddle.

W 13 available in this drive option



PTO-BD

PTO Belt Drive

The belt drive runs from the gear box to the jack shaft near the auger wheels - keeping the auger intake away from the tractor. This allows for more working room and longer bin reach. The drive can be positioned to left or right hand drive and the non-separable 48" PTO can be extended to 68" and is guided by an anti-belt-whip. A driveline saddle holds the drive in place when the auger is in transport.





OPTIONAL FEATURES

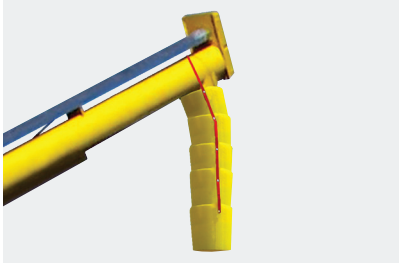

Flex Spout

With five bucket sections, the flex spout directs grain flow and reduces spillage. Available in polythylene.



Swivel Arc Kits

The Swivel Arc Kit allows the auger to move around circular bin setups.

Available only on the WR 6



Poly Hoppers

Poly hoppers are durable and flexible providing easy grain handling with minimum spillage.

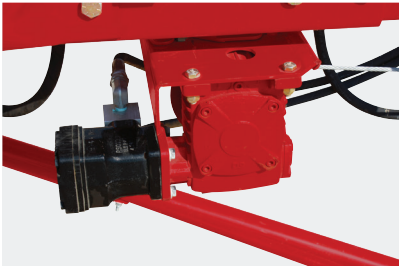

Hydraulic Winch

High capacity winch with automatic brake allows the user to raise and lower the auger easily with less effort than a hand winch.

W 13-51/61/71 come with hydraulic lift
W 13-31/36/41 come standard with hand winch



Bin Hopper Dimensions:
40" Long x 40" Wide

Steel Intake Hoppers

The self-leveling steel intake hopper has a tapered transition neck to direct grain from the hopper into the auger, removable access plate for easy clean-out, a tow hitch and stabilizer bar. Optional wheel kit available.

Available only on the W 13



Wheel Kit

The wheel kit helps move the auger into position easily and works best when using a steel intake hopper.

Available only on the W 13



Enclosed Collapsible Hopper

The new enclosed collapsible hopper is a cost effective option that delivers ease of use and maximized efficiency. The hopper mounts over your existing intake cage and releases with the removal of two hitch pins. A removable access door makes for easy clean-out. Comes complete with tow hitch.

Available only on the W 13

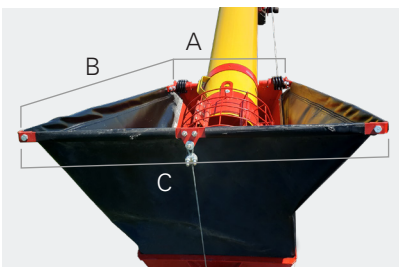

SPECIFICATIONS

	13"
A	20.75"
B	36.5"
C	37.5"

	13"
COLLAPSED HEIGHT	11"
TOTAL HEIGHT	29"

WR+W

HEIGHT | REACH | WHEEL | SPECIFICATIONS

WR	A HEIGHT LOWERED	B HEIGHT HALFWAY	C HEIGHT RAISED	D REACH LOWERED	E REACH HALFWAY	F REACH RAISED	G HEIGHT AT LIFTARMS	H HEIGHT AT WHEELS	I REACH TO LIFTARMS	WHEEL TREAD
26'	6' 5"	12' 8"	17' 11"	10' 9"	9' 5"	7' 3"	7' 9"	11' 4"	6' 10"	68"
31'	7' 8"	15' 1"	21' 6"	13' 9"	12' 0"	9' 3"	8' 10"	12' 10"	7' 8"	70"
36'	9' 0"	17' 4"	24' 10"	16' 3"	14' 3"	11' 2"	10' 0"	14' 4"	8' 11"	82"
41'	9' 7"	20' 2"	28' 7"	18' 8"	16' 4"	12' 8"	11' 6"	16' 4"	10' 2"	88"
51'	11' 11"	25' 0"	35' 0"	23' 1"	20' 2"	15' 10"	14' 2"	19' 11"	12' 10"	94"
61'	11' 8"	28' 4"	41' 0"	27' 4"	24' 4"	19' 0"	17' 2"	24' 3"	16' 2"	112"
W										
31'	7' 7"	13' 9"	19' 3"	13'	11' 9"	9' 8"	9'	12' 5"	8'	106"
36'	7' 10"	15' 4"	22' 1"	15'	14' 2"	12' 11"	9' 6"	12' 10"	11' 1"	106"
41'	10' 0"	19' 9"	28' 3"	16' 5"	14' 5"	11' 3"	—	—	—	94"
51'	10' 9"	21' 10"	35' 5"	22' 4"	20' 2"	15' 3"	—	—	—	112"
61'	11' 7"	25' 8"	41' 1"	27' 5"	24' 10"	20' 0"	—	—	—	118"
71'	12' 11"	30' 10"	47' 0"	32' 3"	29' 5"	23' 1"	—	—	—	124"

Recommended Pulley Sizes:

- Gas Motor Drives: 4.2" Double Groove Pulley
- Electric Motor Drives: 7.75"
< 41' Double Groove, > 41' Triple Groove Pulley

HORSEPOWER REQUIREMENTS

	6"			13"	
	GAS HP	PTO HP	ELEC. HP	PTO HP	ELEC. HP
26'	10	—	3	—	—
31'	10	—	3	40	20
36'	12	—	3	40 - 50	20 - 25
41'	12	—	3	50	25
51'	—	20	5	70	—
61'	—	25	7.5	80	—
71'	—	—	—	90	—

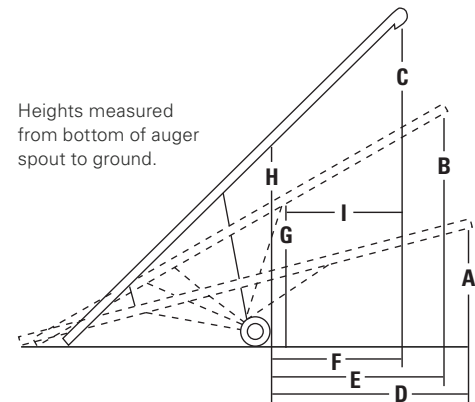

Disclaimer: The WR+W series auger was proudly designed to handle dry, free-flowing grains up to a maximum density of 65 lb/bu (52 lb/cf). Any usage of this auger outside of this is not authorized by AGI Westfield



WESTFIELD is an AGI Brand.

AGI is a leading provider of equipment solutions for agriculture bulk commodities including seed, fertilizer, grain, and feed systems with a growing platform in providing equipment and solutions for food processing facilities. AGI has manufacturing facilities in Canada, the United States, the United Kingdom, Brazil, India and Italy and distributes its products globally.

AGI **WESTFIELD**

198 Commerce Drive, Winnipeg, Manitoba, Canada R3P 0Z6
 1.855.432.1990 | aggrowth.com/westfield

AGGROWTH.COM [aggrowthintl](#)     