

Owners Manual



Smart-Till®

Models SMT101, SMT151, SMT203, and SMT303

HCC, inc.
1501 1st Avenue
Mendota, IL 61342
815-539-9371
www.hccincorporated.com

C-1183
January 2014

Safety

Most work related accidents are caused by failure to observe basic safety rules or precautions. An accident can often be avoided by recognizing potentially hazardous situations before an accident occurs. As you assemble, operate, or maintain the Smart-Till®, you must be alert to potential hazards. You should also have the necessary training, skills, and tools to perform this assembly procedure.

Improper operation and maintenance of this implement could result in a dangerous situation that could cause injury or death.

Do not assemble, operate, or maintain the Smart-Till® until you read and understand the information contained in this manual.



Safety precautions and warnings are provided in this manual and on the product. If these hazard warnings are not heeded, bodily injury or death could occur to you or to other persons.

HCC cannot anticipate every possible circumstance that might involve a potential hazard. The warnings in this supplement and on the product are, therefore, not all-inclusive. If a method of operation not specifically recommended by HCC is used, you must satisfy yourself that it is safe for you and for others. You should also ensure that the implement will not be damaged or be made unsafe by the methods that you choose.

The information, specifications, and illustrations in this supplement are based on the information that was available at the time this material was written and can change at any time.

Safety Alert Symbols



The safety alert triangle means **Attention! Become Alert! Your Safety is Involved.**

Hazards are identified by the “Safety Alert Symbol” and followed by a signal word such as “DANGER”, “WARNING”, or “CAUTION”.

DANGER

DANGER: Indicates an imminently hazardous situation which, if not avoided, will result in death or serious injury. This signal word is limited to the most extreme situations.

WARNING

WARNING: Indicates a potentially hazardous situation which, if not avoided, could result in death or serious injury.

CAUTION

CAUTION: Indicates a potentially hazardous situation which, if not avoided, may result in minor or moderate injury. It may also be used to alert against unsafe practices.

NOTICE























NOTICE: Indicates that equipment or property damage can result if instructions are not followed.

SAFETY INSTRUCTIONS

SAFETY INSTRUCTIONS: Safety instructions (or equivalent) signs indicate specific safety-related instructions or procedures.



NOTE: Contains additional information important to a procedure.

Safety Icon Nomenclature



-  Read the manual
-  Eye protection
-  Hand protection
-  Inspect equipment
-  Multiple persons required
-  Support stands
-  Use proper tools
-  Warning decal alert
-  Block wheels
-  Crushing hazard
-  Crushing hazard (foot)
-  Crushing hazard (hand)
-  Crushing hazard (overhead)
-  Electrocution hazard
-  Falling hazard
-  High-pressure fluid hazard
-  Negative tongue weight
-  Pressurized fluid
-  Safety alert symbol
-  Sharp object hazard
-  Slipping injury
-  Tripping injury

Safety Warnings

WARNING

  To avoid personal injury or death, carefully read and understand all instructions before attempting to assemble, operate, or maintain the Smart-Till®. Do not operate or work on a implement unless you read and understand the instructions and warnings in this and all other applicable manuals. Contact HCC if any of the instructions provided are unclear or not understood. Proper care is your responsibility. Always follow all State and Federal health and safety laws and/or local regulations.



 To avoid eye injury, always wear protective glasses. Make sure no one can be injured by flying objects or debris when using tools or working on a implement.

  Personal injury can result from slips or falls. DO NOT leave tools or parts laying around the work area, and clean up all spilled fluids immediately.

  Tines on the Smart-Till® are sharp. To avoid injury, use caution and always wear protective gloves when working around sharp components.

 Inspect this equipment before each use. Make sure all hardware is tight. Always replace worn or damaged parts before using the implement.

 Make sure all decals are securely attached to the Smart-Till® and are legible at all times. Always read and understand all decals before working on or operating the Smart-Till®.

  Make sure all lock pins and transport supports are secured in place before transporting the Smart-Till®.

Safety Warnings (continued)

WARNING



To avoid serious injury or death, never straddle the tongue when hitching or unhitching. Only unhitch the Smart-Till® with attachments in the transport mode, lock pins installed, or all attachments fully lowered and in contact with the ground.



During implement operation, there can be negative weight on the Smart-Till® hitch which could allow the tongue to raise quickly, resulting in serious injury or death. The Smart-Till® MUST be connected to a tractor with a pintle hook or double clevis hitch arrangement before operating hydraulics.



The Smart-Till® is heavy and is not equipped with brakes. The tires are not rated for on-highway use. Do not exceed 30 km/hour (20 mph) when transporting the implement.



Potential crush hazard. Keep clear when raising or lowering transport wheels, side wings, or rotary harrow attachments. Do not attempt to install or remove lock pins while components are in motion.



To avoid personal injury do not attempt to clean, adjust, or lubricate the Smart-Till® while it is in motion. Never ride on or permit others to ride on the Smart-Till®.



Before performing any maintenance or repairs, always block the wheels and install transport locks (supports) on wheel cylinders. Relieve hydraulic pressure so weight is supported by the locks.



Always block the wheels to prevent movement when the implement is unhitched from the tractor. Movement of the implement, if not correctly blocked, can result in serious injury.

WARNING



When working on the Smart-Till® in the raised position, always install wheel transport locks and position four or more suitable support stands under the implement frame. Use additional stands under side wings, if equipped. Inadequate support stands could collapse, causing serious injury or death. Make sure the stands are capable of supporting the weight of the implement.



To avoid personal injury, never stand with feet under tines while making adjustments or during maintenance. Be extremely careful when working within the implement frame.



To avoid serious injury or death, never stand within the radius of the raised tine gang side wings or rotary harrow attachments.



Before making any adjustments on the implement outside the tractor cab, ensure that all hydraulic levers are in the neutral position. Always shut off tractor, set parking brake, and remove the key before performing any operation or service.



Escaping high-pressure fluid can penetrate the skin, causing serious injury and even death. Relieve pressure before unhooking hoses. Check/tighten all connections before activating hydraulics. Never use your hand to check for leaks.



To prevent personal injury or death, be aware of overhead electrical lines when raising or lowering wings, harrow attachments, and transport wheels, or while operating the Smart-Till® with the attachments in the upright position. Electrocution can occur without direct contact with overhead power lines. Proceed cautiously around electrical lines and utility poles.

Contents

Safety	2
Safety Alert Symbols	2
Safety Icon Nomenclature	3
Safety Warnings	3
Introduction	6
Specifications	6
Assembly Procedure	6
Assembly Quick Reference Guide	7
Unloading	7
Tongue Installation	8
Hydraulic Hose Installation	10
SMT303 Front Brace Installation	12
Rotary Harrow Installation (If Equipped)	15
Phasing the Hydraulic System	17
Hitch Adjustment	20
Operation	22
Field Operating Procedure	22
Connections	24
Transport Wheels	25
Lower (Extend) Wheels	25
Raise (Retract) Wheels	25
Side Wing Folding (Models SMT203 and SMT303 Only)	26
Rotary Harrow Folding (If Equipped)	28
Operating Adjustments	29
Tine Gang Adjustments	29
Operating Speed	31
Tine Gang Settings/Speed Chart	31
Rotary Harrow Adjustments	32
Rotary Harrow Orientation Charts	33
Maintenance	35
Periodic Maintenance	36
Daily Maintenance	36
Maintenance/Lubrication Points	36
Weekly Maintenance	37
Yearly Maintenance	37
Maintenance/Lubrication Chart	37
Service Procedures	38
Tine Gang C-flex Bolt Torque Settings	38
Replace Tines	38
Replace Tine Gang Bearings	39
Adjust Rotary Harrow Tension	42
Replace Rotary Harrow Chain Links	43
Transport Wheel Service	45
Tandem Wheel Service	45
Side Wing Wheel Service	46
Storage	47
Prepare for Storage	47
Remove from Storage	48
Warning Decals	49
Warning Decal Placement	49
Warning Decals	49
Troubleshooting	51
Troubleshooting Chart	51

NOTE: For a listing of serviceable replacement parts, refer to the C-1184 Smart-Till® Parts Manual.

NOTICE

To avoid damage to the implement, DO NOT attempt to unfold (extend) or fold (retract) the side wings and rotary harrow attachments at the same time. When opening the Smart-Till®, always unfold the side wings first, then the rotary harrows. When closing the Smart-Till®, always fold the rotary harrows first, then the side wings.

Introduction

The Smart-Till® is a high-performance tillage implement. Models SMT101 and SMT151 feature a heavy-duty main frame with tongue, multiple tine gangs, dual sets of transport wheels, and optional rotary harrows. Models SMT203 and SMT303 are larger and feature two folding side wings with transport wheels. A hydraulic (tractor supplied power) system with hydraulic cylinders raises and lowers the transport wheels, side wings, and optional rotary harrow gangs.

WARNING



To avoid personal injury or death, do not assemble, operate, or maintain the Smart-Till® until you read and understand the information contained in this manual.

Specifications

Smart Till® SMT101

Tilled Width	10 ft (3 m)
Overall Length	16 ft (4.8 m) w/o harrow attachment 23 ft 6 in (7.7 m) with harrow attachment
Tine Gangs	Four
Harrow Gangs ¹	Two
Tine Spacing	7.5 in (19.05 cm)
Required HP	85 to 130 PTO horsepower
Weight	3,350 lb (1520 kg) w/o harrow attachment 5,250 lb (2381 kg) with harrow attachment
Tire Size (4)	11L-15FI floatation type

¹ Optional.

Smart Till® SMT151

Tilled Width	15 ft (4.6 m)
Overall Length	18 ft 6 in (5.6 m) w/o harrow attachment 26 ft (7.9 m) with harrow attachment
Tine Gangs	Six
Harrow Gangs ¹	Three
Tine Spacing	7.5 in (19.05 cm)
Required HP	130 to 200 PTO horsepower
Weight	5,000 lb (2268 kg) w/o harrow attachment 7,850 lb (3561 kg) with harrow attachment
Tire Size (4)	11L-15FI floatation type

¹ Optional.

Smart Till® SMT203

Tilled Width	19 ft 2 in (5.8 m)
Overall Length	18 ft 6 in (5.6 m) w/o harrow attachment 26 ft (7.9 m) with harrow attachment ¹
Side Wings	Two
Tine Gangs	Eight
Harrow Gangs ¹	Five
Tine Spacing	7.5 in (19 cm)
Required HP	170 to 255 PTO horsepower
Weight	7,500 lb (3402 kg) w/o harrow attachment 11,400 lb (5171 kg) with harrow attachment
Tire Size (6)	11L-15FI floatation type

¹ Optional.

Smart Till® SMT303

Tilled Width	28 ft 4 in (8.9 m)
Overall Length	18 ft 6 in (5.6 m) w/o harrow attachment 26 ft (7.9 m) with harrow attachment ¹
Side Wings	Two
Tine Gangs	Twelve
Harrow Gangs ¹	Seven
Tine Spacing	7.5 in (19 cm)
Required HP	255 to 380 PTO horsepower 300 to 450 ENGINE horsepower
Weight	10,500 lb (4763 kg) w/o harrow attachment 16,000 lb (7257 kg) with harrow attachment
Tire Size (6)	11L-15FI floatation type

¹ Optional.

Assembly Procedure

NOTE: Photographs or illustrations in this publication may show details that can be different from your Smart-Till®. Differences in Smart-Till® models and advancement of product design might have caused changes, which are not included in this publication.

WARNING



Smart-Till® components are very large and heavy. To help prevent possible injuries, two or more persons are required for unloading and assembly procedures.

⚠ WARNING



To avoid personal injury or death, carefully read and understand all instructions before attempting to assemble, operate, or maintain the Smart-Till®. Do not operate or work on a implement unless you read and understand the instructions and warnings in this and all other applicable manuals. Contact HCC if any of the instructions provided are unclear or not understood. Proper care is your responsibility. Always follow all State and Federal health and safety laws and/or local regulations.

Assembly Quick Reference Guide

1. Unloading
2. Tongue Installation
3. Hydraulic Hose Installation
4. Front Brace Installation (SMT303 only)
5. Rotary Harrow Gang Installation
6. Phasing the Hydraulic System
7. Hitch Adjustment

Unloading

The Smart-Till® is shipped in sections. The box containing the hardware is attached to the main frame.

⚠ DANGER



Before starting the unloading procedure, make sure the overhead lifting device or a material handling device (forklift) has adequate capacity. Follow all safety recommendations when unloading the Smart-Till®. Some components can weigh in excess of 7000 lb (3175 kg) and will result in serious injury or death if not adequately supported during removal.

1. Use a suitable lifting device to unload the Smart-Till® components.

NOTE: For ease of assembly, unload the Smart-Till® components in the area where they will be assembled. Choose a large, clear, flat area that can safely support the weight of the assembled implement.

⚠ DANGER



Inadequate support stands could collapse, resulting in serious injury or death. Make sure support stands are capable of supporting the weight of the implement.

2. Support the tine gangs with the steel shipping stands. The main frame must be stable before implement assembly.

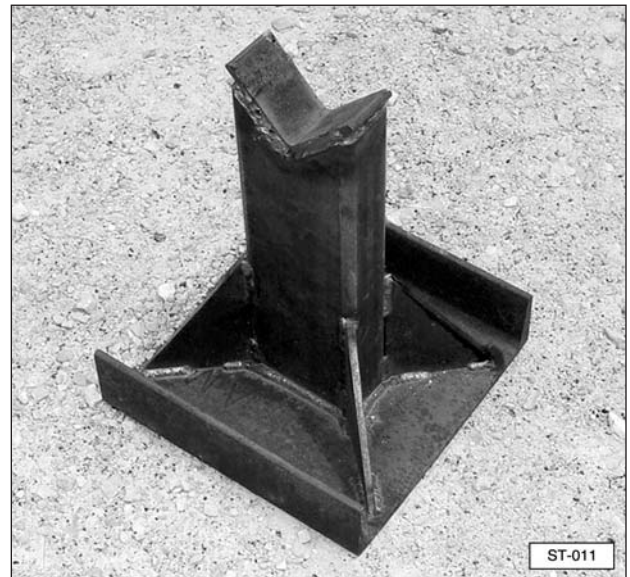

Steel Shipping Stand.

WARNING



If the main frame is shipped with the wheels locked in the extended (down) position, block the wheels to prevent movement when the main frame is lowered to the ground. Movement of the implement, if not correctly blocked, can result in serious injury.



Block the Wheels.

Tongue Installation

DANGER



The main frame must be stable before installing the tongue. To prevent serious injury or death, make sure the wheels are blocked and/or shipping stands are securely positioned under the main frame tine gangs.



Before installing the tongue, make sure it is adequately supported using an overhead lifting device or a material handling device (forklift). Follow all safety recommendations when positioning the tongue. The tongue can weigh in excess of 1000 lb (454 kg) and will result in serious injury or death if not adequately supported during installation.

1. Locate the hardware needed to install the tongue. This includes four large U-bolts, flat washers, and self-locking nuts plus four large bolts, flat washers, and self-locking nuts.
2. Use a suitable lifting device to position the tongue so that the rear mounting holes in the main frame and tongue align.
3. Install the four bolts, flat washers, and self-locking nuts (A) through the main frame and tongue mounting bracket. Do not completely tighten the nuts at this time.



(A) Rear Tongue Mounting Bracket Nut.

NOTICE

The tongue rear mounting holes are slotted. To ensure the side wings operate smoothly, the tongue must be centered on the main frame by adjusting (sliding) the tongue so the slot gaps are equal on each leg of the tongue.

4. Install the four U-bolts over the front main frame tube and through the plate on the tongue. Install the flat washers and self-locking nuts. Tighten the nuts securely.

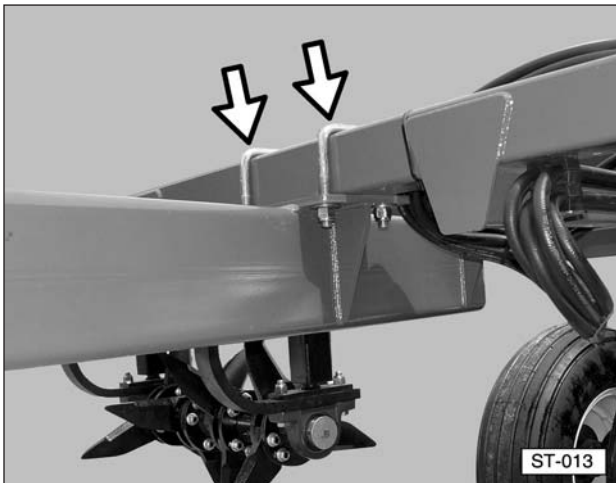

5. Completely tighten the four (two on each side) rear mounting bracket bolts and self-locking nuts (A) installed in Step 3.

NOTICE

To prevent damage to the implement, make sure the support jack is positioned on stable ground. If necessary, place a strong board or metal plate under the stand.

- 6a. If necessary, remove the lock pin and move the jack from the storage position to the support position inside the tongue frame. Insert the lock pin.
- 6b. Use the crank to extend the jack and support the weight of the tongue. Remove the lifting device and/or other supports.



NOTE: When not in use, the support jack should be folded up or stored on the mounting stub located on top of the tongue frame rail, if equipped.

7. Install hitch clevis (A) on the front of the tongue with supplied hardware (B).

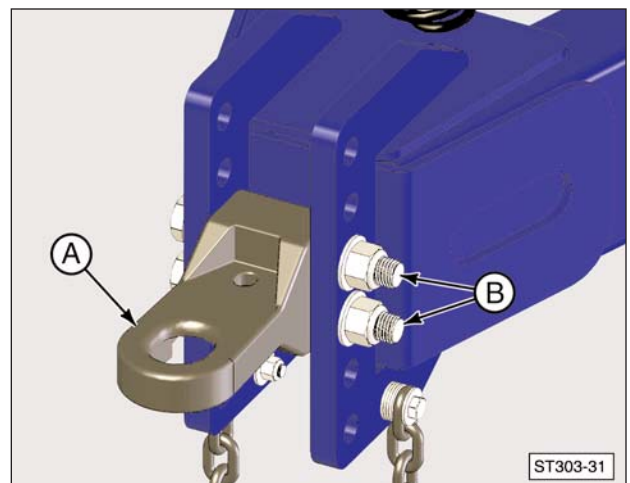

(A) Hitch Clevis.
(B) Hitch Mounting Hardware.

NOTE: Final installation of the clevis hitch is done with the implement at working height. For more information, refer to the Hitch Adjustment section in this manual.

⚠ WARNING



To avoid serious injury or death, never straddle the tongue when hitching or unhitching. Only unhitch the Smart-Till® with attachments in the transport mode, lock pins installed, or all attachments fully lowered and in contact with the ground.



During implement operation, there can be negative weight on the Smart-Till® hitch which could allow the tongue to raise quickly, resulting in serious injury or death. The Smart-Till® MUST be connected to a tractor with a pintle hook or double clevis hitch arrangement before operating hydraulics.

- Hitch the Smart-Till® to a suitable tractor. Make sure the hitch is a style that prevents the implement hitch from “lifting off” the connection. For more information, refer to the Connections section in this manual.

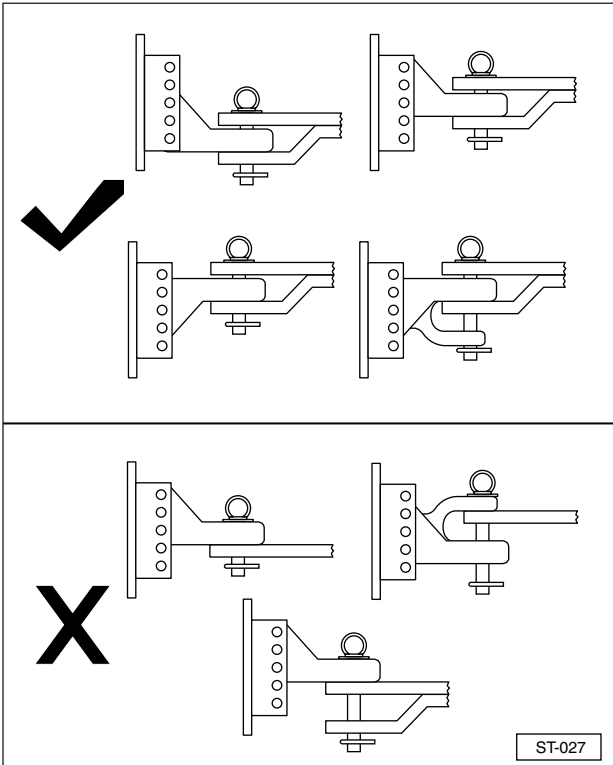

- Connect the light harness plug into the tractor connection. Verify that all the implement lights operate correctly.

NOTE: When not in use, the harness plug can be protected from dirt and corrosion by inserting it in the plug guard and twisting to lock it in position. Twist and pull to unlock the plug when connecting to the tractor.



Hydraulic Hose Installation

⚠ WARNING



During implement operation, there can be negative weight on the Smart-Till® hitch which could allow the tongue to raise quickly, resulting in serious injury or death. The Smart-Till® MUST be connected to a tractor with a pintle hook or double clevis hitch arrangement before operating hydraulics.

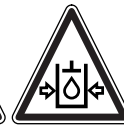

Escaping high-pressure fluid can penetrate the skin causing serious injury and even death. Relieve pressure before unhooking hoses. Check/tighten all connections before activating hydraulics. Never use your hand to check for leaks.

The Smart-Till® is shipped with the hydraulic hoses connected to the hydraulic cylinders. The hydraulic hoses are coiled and secured to the main frame for shipment.

1. Cut and discard the tie wraps securing the hydraulic hoses to the main frame and uncoil the hoses.

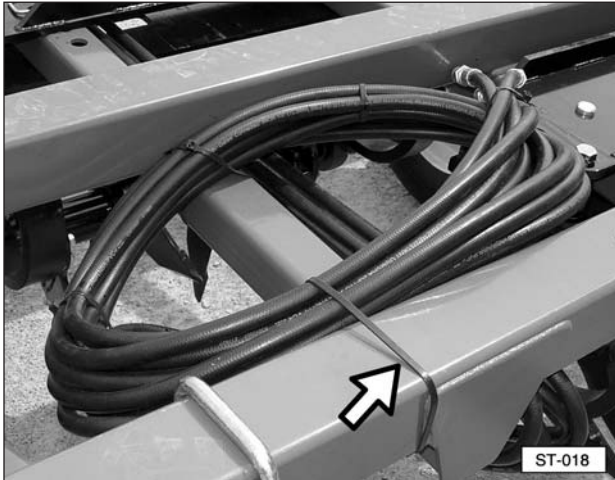

NOTE: Smart-Till® implements can have from one to three sets of color coded hydraulic hoses, depending on the model and optional attachments.

2. There are hose guide clamps mounted along the tongue rail. Remove the hose guide clamp bolts and outer clamps. Neatly route the hydraulic hoses through the hose guides and along the tongue rail towards the front of the implement. Install the outer clamps and bolts and tighten the bolts.

NOTE: Model SMT303 shown with the front brace installed. Other models are similar.

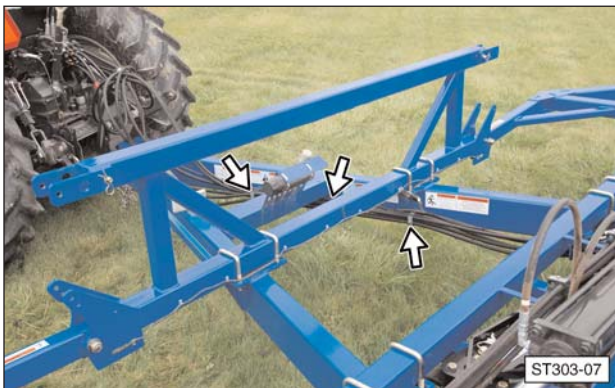

3. The ends of the hydraulic hoses are color-coded and should be inserted in the keyhole bracket when not connected.

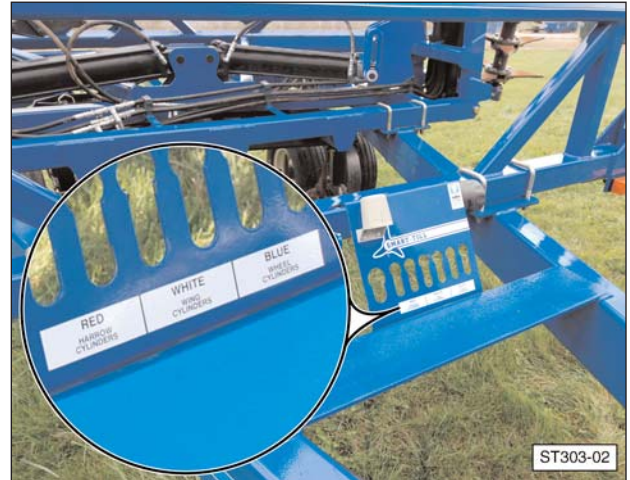

NOTICE

To prevent contamination of the hydraulic system, make sure all quick coupler fittings are clean before connecting hoses.

4. With the Smart-Till® properly hitched to a tractor, connect the color-coded hydraulic hoses to the tractor hydraulic system.
 - a. BLUE - Transport Wheel Cylinders
 - b. WHITE - Wing Cylinders, if equipped
 - c. RED - Harrow Cylinders, if equipped

NOTICE

The implement hydraulic system must be connected to a hydraulic power supply and “charged” with hydraulic fluid before use. Check and refill the tractor’s hydraulic power supply reservoir after charging the hydraulic system.

NOTE: For more information on charging and synchronizing the Smart-Till® hydraulic systems, refer to the Phasing the Hydraulic System section in this manual.

SMT303 Front Brace Installation

NOTE: The front brace is only used on the Smart-Till® Model SMT303. For Smart-Till® implements that do not require a front brace, skip to the Rotary Harrow Gang Installation section.

⚠ DANGER



The main frame and tongue must be stable before installing the front brace. To prevent serious injury or death, make sure the wheels are blocked and the tongue is properly hitched to a suitable tractor.



Front brace sections are heavy and can result in serious injury or death if not adequately supported during installation. Make sure sections are adequately supported using an overhead lifting device or a material handling device (forklift). Follow all safety recommendations when positioning each front brace section.

The front brace assembly is shipped in three sections. The center tube weldment, left side wing brace, and right side wing brace are installed on the implement individually and connected at the front pivot points.

NOTICE

To prevent damage to the Smart-Till®, make sure all transport lock pins are removed before operating the hydraulic system.

1. The Smart-Till® must be properly hitched to a tractor, on firm level ground, and the hydraulic system connected before proceeding.
2. Locate the hardware needed to install the front brace. This includes twelve large U-bolts with flat washers and self-locking nuts, and two large pivot bolts with flat washers and self-locking nuts.

3. Make sure all side wing shipping straps, bands, or braces are removed. Activate the tractor hydraulic system to completely unfold the Smart-Till® side wings.

NOTE: For more information on operating the Smart-Till® hydraulic systems, refer to the appropriate Operation section in this manual.

4. Install the center front brace tube. Shut off the tractor, place the hydraulic levers in neutral, and set the parking brake.
 - a. Use a suitable lifting device to install front brace weldment (A) on the tongue mounting pads, with the running lights facing forward.
 - b. Center the front brace weldment and install four U-bolts (B) over the front brace tube and through the plates on the tongue. Install the flat washers and self-locking nuts. **Do not** completely tighten the nuts at this time.
 - c. Connect the front brace weldment running light wiring harness plug to the main wiring harness connector located on the implement tongue (not shown).

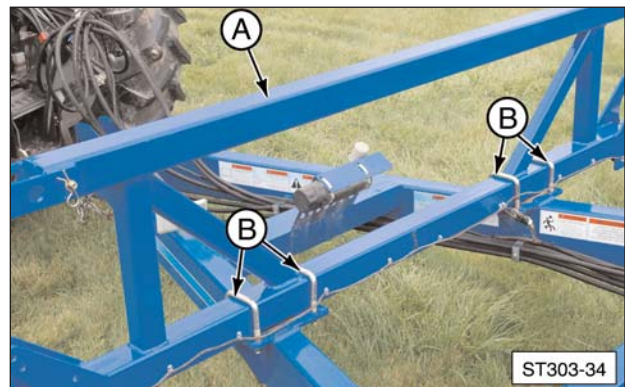

(A) Front Brace Weldment. (B) U-bolts.

5. Install the right side front brace.
 - a. Position the right side section on the right side wing with the pivot point aligned with front brace weldment (B) tube.

- b. Install four U-bolts (C) over the side wing tube and through the plates on the right side brace. Install the flat washers and self-locking nuts. **Do not** completely tighten the nuts at this time.
- c. Install side wing pivot bolt (D), lockwasher, and nut, and tighten securely.

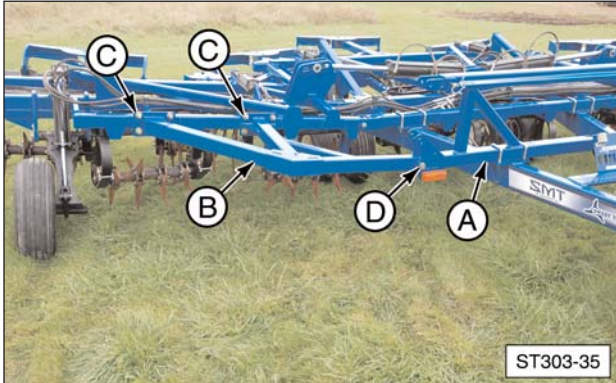

(A) Front Brace Weldment. (B) Right Side Front Brace. (C) U-bolts (qty 4). (D) Pivot Bolt.

- 6. Repeat Steps 5a, 5b, and 5c to install the left side brace on the left side wing of the Smart-Till®.

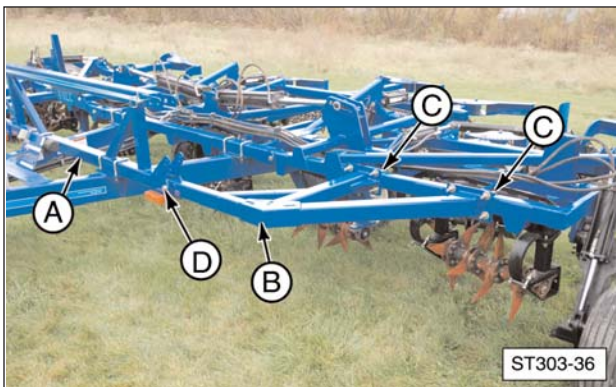

(A) Front Brace Weldment. (B) Left Side Front Brace. (C) U-bolts (qty 4). (D) Pivot Bolt.

- 7. Align the side wing braces.

- a. Activate the tractor hydraulic system to completely fold the side wings.



- b. Remove left side and right side hitch clips and lock pins (A) from the storage position and install in upper braces to lock both wings in the folded position.

NOTE: The vertical wing tubes should be folded in close to the front brace weldment cross tube, allowing easy insertion of lock pins (A), as shown.

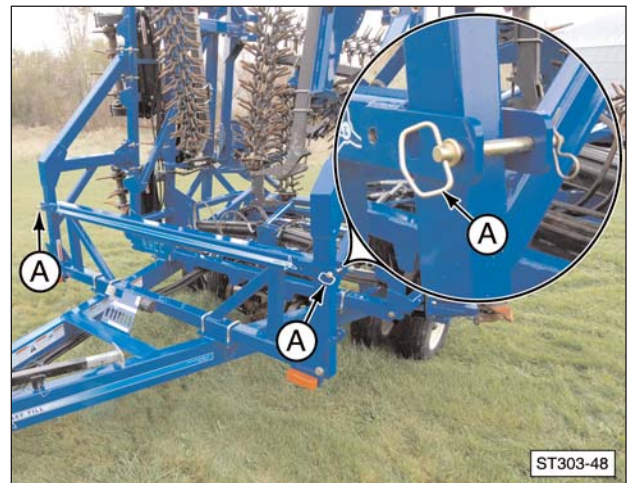

(A) Lock Pins with Hitch Clips (enlargement shows the lock pin in the transport location).

- c. Make sure the metal contact pad, below the hydraulic cylinder mount on each side wing, is resting on the Smart-Till® main frame.

NOTE: To show the contact pad, the inset in the photo below points to the pad location with the side wing unfolded (extended).



- d. Completely tighten four center brace weldment to tongue U-bolts (A).
- e. Completely tighten eight side wing brace to side wing frame U-bolts (C) (four on each wing).

- 8. Remove hitch clips and lock pins (A) from the upper braces and install in the storage location.



(A) Lock Pins with Hitch Clips (enlargement shows the lock pin in the storage location).

- 9. Activate the tractor hydraulic system to completely unfold the side wings.

NOTE: Watch for misalignment or binding during the unfolding operation.



NOTICE

Misalignment of side wing pivot points can cause binding and excessive wear. If necessary, loosen the U-bolts and repeat Step 7 and Step 8 to adjust the pivot point alignment in order to achieve the best possible side wing operation.

Rotary Harrow Installation (If Equipped)

NOTE: For Smart-Till® implements that do not have rotary harrows, skip to the Phasing the Hydraulic System section.

WARNING



During implement operation, there can be negative weight on the Smart-Till® hitch which could allow the tongue to raise quickly, resulting in serious injury or death. The Smart-Till® **MUST** be connected to a tractor with a pintle hook or double clevis hitch arrangement before operating hydraulics.



Before making any adjustments on the implement outside the tractor cab, ensure that all hydraulic levers are in the neutral position. Always shut off tractor, set parking brake, and remove the key before performing any operation or service.



Escaping high-pressure fluid can penetrate the skin, causing serious injury and even death. Relieve pressure before unhooking the hoses. Check/tighten all connections before activating hydraulics. Never use your hand to check for leaks.



Potential crush hazard. Keep clear when raising or lowering transport wheels, side wings, or rotary harrow attachments. Do not attempt to install or remove lock pins while components are in motion.



To avoid serious injury or death, never stand within the radius of the raised tine gang side wings or rotary harrow attachments.

NOTE: Depending on the Smart-Till® model and the shipping method, one or more of the rotary harrow gangs may need to be installed on the harrow frames. For implements that do not require rotary harrow installation, skip to the Phasing the Hydraulic System section.

NOTICE

Refer to the Harrow Gang Orientation Chart in this manual for information on the correct location and orientation of all rotary harrow gangs.

1. The Smart-Till® must be properly hitched to a tractor on firm, level ground, and the hydraulic system connected before proceeding.
 - a. BLUE - Transport Wheel Cylinders
 - b. WHITE - Wing Cylinders, if equipped
 - c. RED - Harrow Cylinders, if equipped

NOTICE

To prevent contamination of the hydraulic system, make sure all quick coupler fittings are clean before connecting the hoses.

DANGER



Follow all safety recommendations when installing harrow gangs. Each harrow gang can weigh in excess of 500 lb (227 kg) and can cause serious injury or death if not adequately supported during installation.

NOTICE

To prevent damage to the Smart-Till®, make sure all transport lock pins are removed before operating the hydraulic system.

2. Shut off the tractor, place the hydraulic levers in neutral, and set the parking brake.

- a. If equipped with side wings, remove two side wing frame hitch clips and lock pins (A). Store lock pins in the appropriate storage hole location.

NOTE: Smart-Till® Model SMT303 shown. Other models are similar.



(A) Side Wing Lock Pins (enlargement shows the lock pin in the storage location).

- b. Remove and store two rotary harrow frame hitch clips and lock pins.

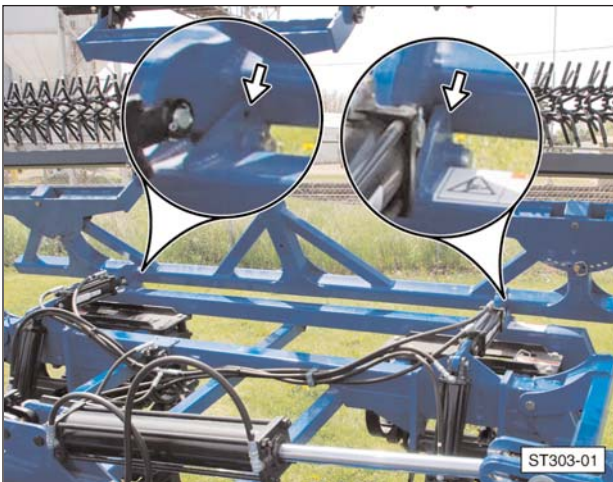

NOTICE

To avoid damage to the implement, DO NOT attempt to unfold (extend) or fold (retract) the side wings and rotary harrow attachments at the same time. When opening the Smart-Till®, always unfold the side wings first, then the rotary harrows. When closing the Smart-Till®, always fold the rotary harrows first, then the side wings.

NOTE: For more information on operating the Smart-Till® hydraulic systems, refer to the appropriate Operation section in this manual.

3. Activate the tractor hydraulic system to:
 - a. Completely unfold the side wings.
 - b. Completely unfold the rotary harrow gangs.
4. Shut off the tractor, place the hydraulic levers in neutral, and set the parking brake.

⚠ DANGER



The rotary harrow gang is heavy and could slide off the end of the rotary harrow support frame, causing serious injury or death. Use caution when installing the rotary harrow gang.

5. Install the rotary harrow gang.
 - a. Use a suitable lifting device to slide the correct rotary harrow gang on to the mounting tube of a harrow frame.
 - b. Attach the harrow gang to the harrow frame with a bolt and self-locking nut (B) in the pivot point hole. Tighten the bolt and self-locking nut securely.

- c. Swing the harrow gang frame to the center adjustment hole and install lock pin and hitch clip (A) to complete the harrow gang installation.

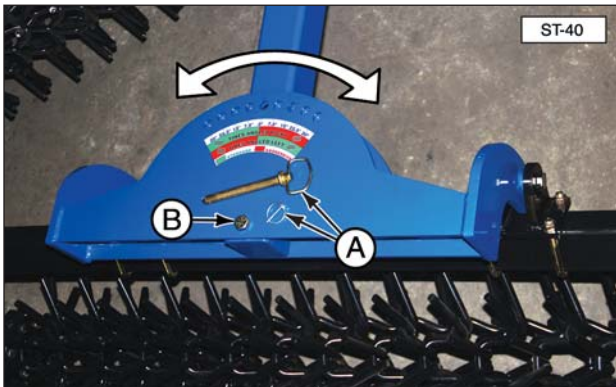

(A) Lock Pin and Hitch Clip. (B) Bolt and Lock Nut.

- 6. Repeat Step 5 to install any remaining harrow gang(s) on the harrow frame.

NOTICE

All rotary harrow gangs must be centered under the mounting brackets. If necessary, loosen the U-bolts and reposition the rotary harrow so there is an equal number of rotary harrow chain links outside each U-bolt.



Phasing the Hydraulic System

NOTE: Phase the transport wheel hydraulic system on all Smart-Till® implements. Also phase the side wing and/or rotary harrow hydraulic systems, if equipped.

WARNING



During implement operation, there can be negative weight on the Smart-Till® hitch which could allow the tongue to raise quickly, resulting in serious injury or death. The Smart-Till® **MUST** be connected to a tractor with a pintle hook or double clevis hitch arrangement before operating hydraulics.



To prevent personal injury or death, be aware of overhead electrical lines when raising or lowering wings, harrow attachments, and transport wheels, or while operating the Smart-Till® with the attachments in the upright position. Electrocution can occur without direct contact with overhead power lines. Proceed cautiously around electrical lines and utility poles.



Before making any adjustments on the implement outside the tractor cab, ensure that all hydraulic levers are in the neutral position. Always shut off the tractor, set the parking brake, and remove the key before performing any operation or service.



To avoid serious injury or death, never stand within the radius of the raised tine gang side wings or rotary harrow attachments.

Before using the Smart-Till® in the field, the hydraulic system must be cycled to remove air and phase (synchronize) the hydraulic cylinders. Any time the hydraulic system is opened for repair or service, and after long periods of storage, this procedure must be repeated.

NOTICE

To prevent contamination of the hydraulic system, make sure all quick coupler fittings are clean before connecting hoses.

NOTE: Smart-Till® implements can have from one to three sets of color-coded hydraulic hoses, if equipped with side wings and/or rotary harrows.

1. With the Smart-Till® properly hitched to a tractor, connect the color-coded hydraulic hoses to the tractor hydraulic system.
 - a. BLUE - Transport Wheel Cylinders
 - b. WHITE - Wing Cylinders, if equipped
 - c. RED - Harrow Cylinders, if equipped
2. Activate the tractor hydraulic system to:
 - a. Completely extend the tandem wheel hydraulic cylinders.
 - b. Remove the tandem wheel lock pins and transport supports and store them in the designated location on the main frame.



NOTICE

To prevent damage to the Smart-Till®, make sure all transport lock pins are removed before operating the hydraulic system.

3. Shut off the tractor, place the hydraulic levers in neutral, and set the parking brake.
 - a. Remove two side wing frame lock pins (A). Store the lock pins in frame bracket (B), as shown.

NOTE: Smart-Till® Model SMT303 shown. Other models are similar.



(A) Side Wing Lock Pins (enlargement shows the lock pin in the storage location).

- b. Remove the two rotary harrow frame lock pins from the rear main frame. Store the pins in a secure location.

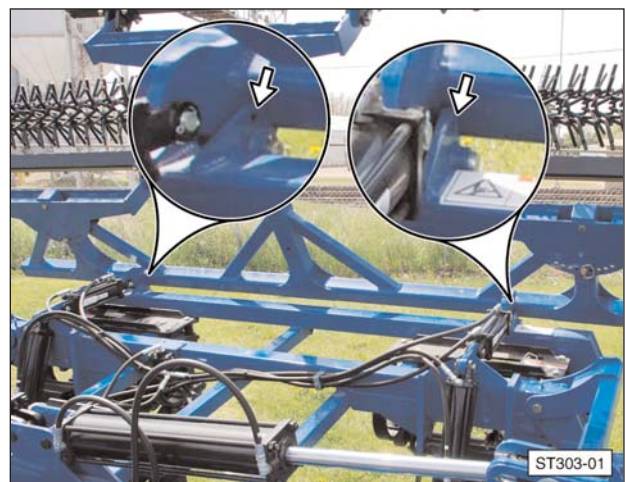

4. Activate the tractor hydraulic system to:
 - a. Completely lower the Smart-Till® into field position (wheels retracted).
 - b. Completely raise the Smart-Till® into transport position (wheels extended).
 - c. Repeat Step a. and Step b. several times until all wheels operate smoothly and in unison.

NOTE: If necessary, continue to hold the tractor hydraulic control lever for 10 to 15 seconds after the wheels are fully raised or lowered. This will help purge air from the hydraulic system.



NOTICE

To avoid damage to the implement, DO NOT attempt to unfold (extend) or fold (retract) the side wings and rotary harrow attachments at the same time. When opening the Smart-Till®, always unfold the side wings first, then the rotary harrows. When closing the Smart-Till®, always fold the rotary harrows first, then the side wings.

5. If the implement is equipped with side wings, activate the tractor hydraulic system to:
 - a. Completely unfold the side wings.
 - b. Completely fold the side wings.
 - c. Repeat Step a. and Step b. several times until both wings operate smoothly and in unison.
 - d. Finish this step with the wings in the down (field) position.

NOTE: If necessary, continue to hold the tractor hydraulic control lever for 10 to 15 seconds after the wings are fully folded or unfolded. This will help purge air from the hydraulic system.

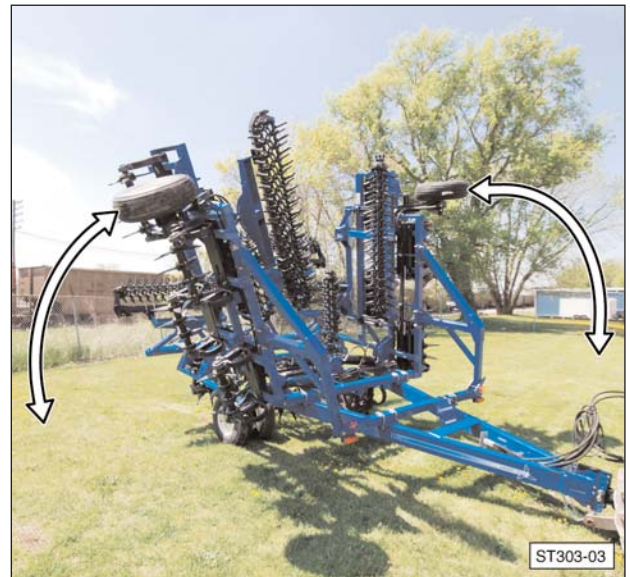

6. If the implement is equipped with optional rotary harrow gangs, activate the tractor hydraulic system to:
 - a. Completely unfold the rotary harrow attachments.
 - b. Completely fold the rotary harrow attachments.
 - c. Repeat Step a. and Step b. several times until all attachments operate smoothly and in unison.

NOTE: If necessary, continue to hold the tractor hydraulic control lever for 10 to 15 seconds after the rotary harrow attachments are fully raised or lowered. This will help purge air from the hydraulic system.



7. When each hydraulic circuit operates smoothly and in unison, the Smart-Till® hydraulic system is phased (synchronized) and ready for normal operation.

Hitch Adjustment

WARNING



During implement operation, there can be negative weight on the Smart-Till® hitch which could allow the tongue to raise quickly, resulting in serious injury or death. The Smart-Till® **MUST** be connected to a tractor with a pintle hook or double clevis hitch arrangement before operating hydraulics.



Before making any adjustments on the implement outside the tractor cab, ensure that all hydraulic levers are in the neutral position. Always shut off the tractor, set the parking brake, and remove the key before performing any operation or service.

The clevis hitch is attached to the Smart-Till® tongue with two bolts and lock nuts. To achieve proper depth control, the hitch must be adjusted so that the Smart-Till® operates with the main frame level (parallel) to the ground.

The Smart-Till® should be located in a level field or area with tillable ground so tines fully penetrate the soil. The Smart-Till® must be hitched to a suitable tractor and the hydraulic system connected.

NOTE: For more information on operating the Smart-Till® hydraulic systems, refer to the appropriate Operation section in this manual.

NOTICE

To prevent damage to the Smart-Till®, make sure all transport lock pins are removed before operating the hydraulic system.

1. Place the Smart-Till® into field operation position.
 - a. Shut off the tractor, place the hydraulic levers in neutral, and set the parking brake. Remove and store the wheel transport locks, and if equipped, the side wing lock pins, and rotary harrow lock pins.
 - b. If equipped with side wings, activate the hydraulic system to lower the side wings to field position.
 - c. Activate the tractor hydraulic system to retract (raise) the wheels and lower the Smart-Till® to field position. The tines must penetrate the soil to working depth (approximately eight inches).

NOTE: Smart-Till® Model SMT303 shown. Other models are similar.



2. Shut off the tractor, place the hydraulic levers in neutral, and set the parking brake. Unbolt the clevis hitch and adjust it up or down, as needed, until it lines up with the drawbar on the tractor.

NOTE: If the weight of the tongue makes bolt removal difficult, use the tongue support jack to support the weight of the tongue. Once the clevis hitch bolts are removed, retract the support jack to allow the main frame to sit at field operation height.

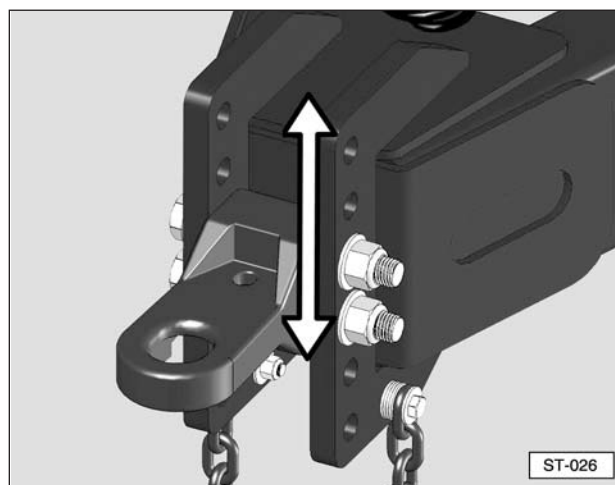

3. Make sure the Smart-Till® main frame is level (parallel) to the ground, and reinstall the hitch mounting hardware at the same height as the tractor drawbar. Tighten the bolts and self-locking nuts securely. Recheck the hardware for tightness after ten hours of operation.

NOTICE

To avoid damage to the Smart-Till®, it is recommended that the implement main frame NOT be operated low in front. If there is no hole position that allows for level operation, attach the clevis in the next lower position to achieve a main frame stance that is slightly high in front, when hitched to the tractor.

Operation

WARNING



To avoid personal injury or death, carefully read and understand all instructions before attempting to assemble, operate, or maintain the Smart-Till®. Do not operate or work on a implement unless you read and understand the instructions and warnings in this and all other applicable manuals. Contact HCC if any of the instructions provided are unclear or not understood. Proper care is your responsibility. Always follow all State and Federal health and safety laws and/or local regulations.



Inspect this equipment before each use. Make sure all hardware is tight. Always replace worn or damaged parts before using the implement.



Make sure all lock pins and transport supports are secured in place before transporting the Smart-Till®.



To avoid serious injury or death, before transporting the Smart-Till® make sure all lights operate correctly. Display required safety signs and follow all highway safety regulations when transporting to and from the field.



To avoid serious injury or death, never straddle the tongue when hitching or unhitching. Only unhitch the Smart-Till® with attachments in the transport mode, lock pins installed, or all attachments fully lowered and in contact with the ground.



During implement operation, there can be negative weight on the Smart-Till® hitch which could allow the tongue to raise quickly, resulting in serious injury or death. The Smart-Till® **MUST** be connected to a tractor with a pintle hook or double clevis hitch arrangement before operating hydraulics.

WARNING



To avoid personal injury, never stand with feet under tines while making adjustments or during maintenance. Be extremely careful when working within the implement frame.



Before making any adjustments on the implement outside the tractor cab, ensure that all hydraulic levers are in the neutral position. Always shut off the tractor, set the parking brake, and remove the key before performing any operation or service.



Potential crush hazard. Keep clear when raising or lowering transport wheels, side wings, or rotary harrow attachments. Do not attempt to install or remove lock pins while components are in motion.



To prevent personal injury or death, be aware of overhead electrical lines when raising or lowering wings, harrow attachments, and transport wheels, or while operating the Smart-Till® with the attachments in the upright position. Electrocution can occur without direct contact with overhead power lines. Proceed cautiously around electrical lines and utility poles.



To avoid serious injury or death, never stand within the radius of the raised tine gang side wings or rotary harrow attachments.

Field Operating Procedure

1. Hitch the Smart-Till® to a suitable tractor. Make sure the hitch is a style that prevents the implement hitch from “lifting off” the connection.
2. Connect the electrical plug for the implement lights to the receptacle on the tractor or vehicle. Verify that all lights operate correctly.

NOTE: Smart-Till® implements can have from one to three sets of color-coded hydraulic hoses, depending on the model and optional attachments.

3. Connect the color-coded hydraulic hoses to the tractor hydraulic system.
 - a. BLUE - Transport Wheel Cylinders
 - b. WHITE - Wing Cylinders, if equipped
 - c. RED - Harrow Cylinders, if equipped

NOTICE

To prevent contamination of the hydraulic system, make sure all quick coupler fittings are clean before connecting hoses.

NOTE: For more information on operating the Smart-Till® hydraulic systems, refer to the appropriate Operation section in this manual.

4. If equipped, activate the tractor hydraulic system to raise the rotary harrows to the transport position.
5. If equipped, activate the tractor hydraulic system to raise the side wings to the transport position.
6. Activate the tractor hydraulic system to extend (lower) the wheels to the transport position.
7. Shut off the tractor, place the hydraulic levers in neutral, and set the parking brake. Install transport wheel locks and all rotary harrow and side wing lock pins.

NOTICE

To avoid damage to the Smart-Till®, do not transport unless the transport supports are secured around the cylinder rods to prevent the wheels from retracting in case of hydraulic failure.

8. Display required safety signs and follow all highway safety regulations to transport the implement to the desired field.

NOTICE

To prevent damage to the Smart-Till®, make sure all transport lock pins are removed before operating the hydraulic system.

9. Shut off the tractor, place the hydraulic levers in neutral, and set the parking brake. If equipped, remove and store the rotary harrow and side wing lock pins.
10. If equipped, activate the tractor hydraulic system to lower the side wings to the field position.
11. If equipped, activate the tractor hydraulic system to lower the rotary harrows to the field position.
12. Set tine gang and rotary harrow angle and orientation according to field conditions and desired tillage.

NOTE: For more information on adjusting the Smart-Till®, refer to the Operating Adjustments section in this manual.

13. If necessary, grease the Smart-Till® following the Maintenance/Lubrication Chart guidelines located in the Maintenance section of this manual.
14. Remove and store the transport wheel locks. Activate the tractor hydraulic system to retract (raise) the wheels to the field work position.
15. Start field operation. Monitor tillage results and make tractor speed, tine gang angle, and rotary harrow angle adjustments, as needed, to achieve the desired tillage.

NOTICE

Always raise the tines out of the ground when making sharp turns. Failure to raise the tines when making turns will damage the bearings and dramatically shorten bearing service life.

Connections

WARNING



To avoid serious injury or death, never straddle the tongue when hitching or unhitching. Only unhitch the Smart-Till® with attachments in the transport mode, lock pins installed, or all attachments fully lowered and in contact with the ground.



During implement operation, there can be negative weight on the Smart-Till® hitch which could allow the tongue to raise quickly, resulting in serious injury or death. The Smart-Till® MUST be connected to a tractor with a pintle hook or double clevis hitch arrangement before operating hydraulics.

The clevis style hitch must be attached to a tractor or vehicle prior to making any hydraulic connections. Make sure the hitch is a style that prevents the implement hitch from “lifting off” the connection.

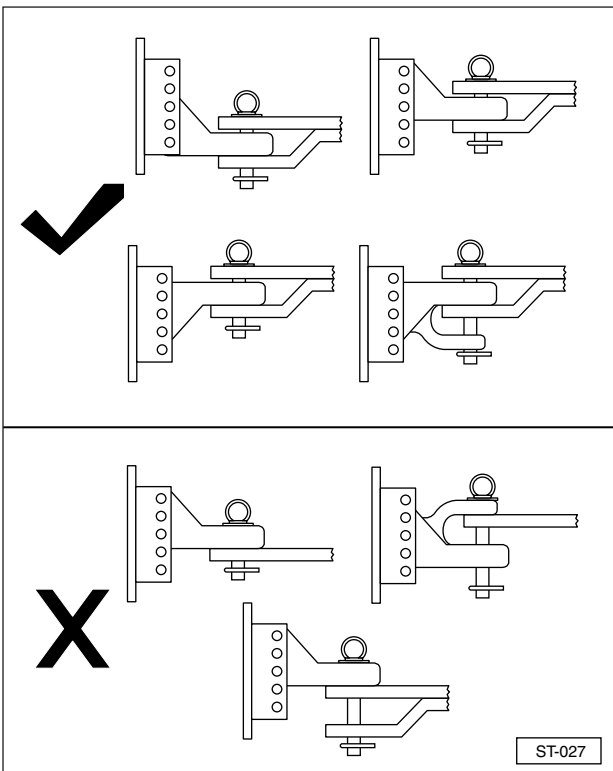

- Hitch the Smart-Till® to a tractor with the required horsepower.
 - SMT101 - 83 to 130 PTO horsepower
 - SMT151 - 130 to 200 PTO horsepower
 - SMT203 - 170 to 255 PTO horsepower
 - SMT303 - 255 to 380 PTO horsepower or 300 to 450 ENGINE horsepower
- Connect the electrical plug for the implement lights to the receptacle on the tractor or vehicle. Verify that all lights operate correctly.

NOTE: Smart-Till® implements can have from one to three sets of color-coded hydraulic hoses, depending on the model and optional attachments.

NOTICE

To prevent contamination of the hydraulic system, make sure all quick coupler fittings are clean before connecting the hoses.

- Connect the color-coded hoses to the hydraulic hookups on the tractor. These connections are:
 - a. BLUE - Transport Wheel Cylinders
 - b. WHITE - Wing Cylinders, if equipped
 - c. RED - Harrow Cylinders, if equipped

NOTICE

To prevent damage to the Smart-Till®, make sure all transport lock pins are removed before operating the hydraulic system.

Transport Wheels

WARNING



Potential crush hazard. Keep clear when raising or lowering transport wheels, side wings, or rotary harrow attachments. Do not attempt to install or remove lock pins while components are in motion.

Lower (Extend) Wheels

1. With the implement properly hitched to a tractor, remove the transport supports from the storage locations.

NOTE: Smart-Till® Model SMT101 shown. Other models are similar.

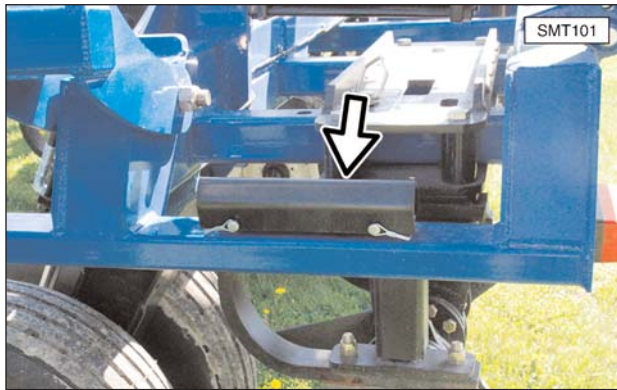

2. Activate the tractor hydraulic system to fully extend the transport wheel hydraulic cylinders and raise the tines off the ground.



3. Shut off the tractor, place the hydraulic levers in neutral, and set the parking brake. Install both transport supports around the tandem wheel hydraulic cylinder rods. Secure with the lock pins, as shown.



NOTE: The single outer transport wheels located on each side wing do not require transport supports.

NOTICE

To avoid damage to the Smart-Till®, do not transport unless the transport supports are secured around the cylinder rods to prevent the wheels from retracting in case of hydraulic failure.

Raise (Retract) Wheels

1. With the implement properly hitched to a tractor, activate the hydraulic system to fully extend the wheel hydraulic cylinders and release any pressure on the transport support locks.

2. Shut off the tractor, place the hydraulic levers in neutral, and set the parking brake. Remove the lock pins and transport supports and secure in the designated storage locations.



NOTE: Smart-Till® Model SMT101 shown. Other models are similar.

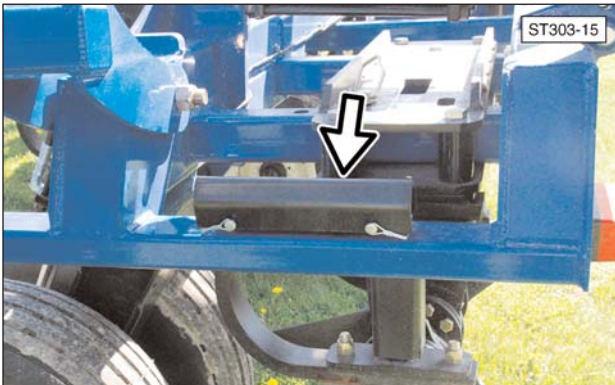

3. Activate the hydraulic system to retract the wheel support hydraulic cylinders and lower the Smart-Till® to field position.



Side Wing Folding (Models SMT203 and SMT303 Only)

WARNING



Potential crush hazard. Keep clear when raising or lowering transport wheels, side wings, or rotary harrow attachments. Do not attempt to install or remove lock pins while components are in motion.



To avoid serious injury or death, never stand within the radius of the raised tine gang side wings or rotary harrow attachments.

NOTICE

To avoid damage to the implement, DO NOT attempt to unfold (extend) or fold (retract) the side wings and rotary harrow attachments at the same time. When opening the Smart-Till®, always unfold the side wings first, then the rotary harrows. When closing the Smart-Till®, always fold the rotary harrows first, then the side wings.

1. With the implement properly hitched to a tractor, remove hitch clips and lock pins (A) from the side wing transport brackets. Store the pins in the provided storage locations.

NOTE: Smart-Till® Model SMT303 shown. Other models are similar.



(A) Side Wing Lock Pins (enlargement shows pins in the storage location).

2. Activate the hydraulic system to completely unfold and lower (extend) the side wing attachments into field position.



3. Activate the hydraulic system to completely raise and fold the side wing attachments into transport position.



4. Remove hitch clips and lock pins (A) from the storage location and install them in the side wing transport brackets to lock both wings in the transport position.

NOTE: Smart-Till® Model SMT303 shown. Other models are similar.

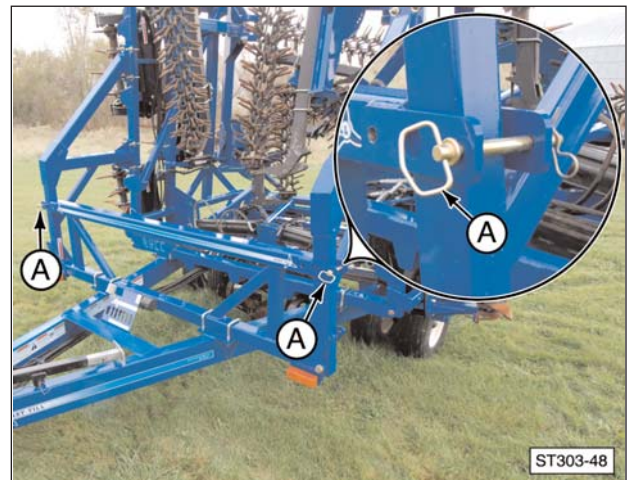

(A) Side Wing Lock Pins (enlargement shows pins in the transport location).

Rotary Harrow Folding (If Equipped)

⚠ WARNING



Potential crush hazard. Keep clear when raising or lowering transport wheels, side wings, or rotary harrow attachments. Do not attempt to install or remove lock pins while components are in motion.



To avoid serious injury or death, never stand within the radius of the raised tine gang side wings or rotary harrow attachments.

NOTICE

To avoid damage to the implement, DO NOT attempt to unfold (extend) or fold (retract) the side wings and rotary harrow attachments at the same time. When opening the Smart-Till®, always unfold the side wings first, then the rotary harrows. When closing the Smart-Till®, always fold the rotary harrows first, then the side wings.

1. If equipped with rotary harrows, shut off the tractor, place the hydraulic levers in neutral, and set the parking brake. Remove each transport lock pin from the rotary harrow frame pivot brackets.



NOTE: Store lock pins, with hitch-clips, in a secure location.

2. Activate the hydraulic system to unfold the rotary harrow attachments and lower them to the field position.

NOTE: Smart-Till® Model SMT303 shown. Other models are similar.



3. Activate the hydraulic system to completely raise and fold the rotary harrow gang attachments to the transport position.



NOTE: On Model SMT303, the two outer rotary harrow gangs fold down against support bracket weldments. The center rotary harrow gangs raise to an “over center” position for transport.



4. Shut off the tractor, place the hydraulic levers in neutral, and set the parking brake. Insert each transport lock pin in the rotary harrow frame pivot brackets. Secure the pins with the hitch-clips.

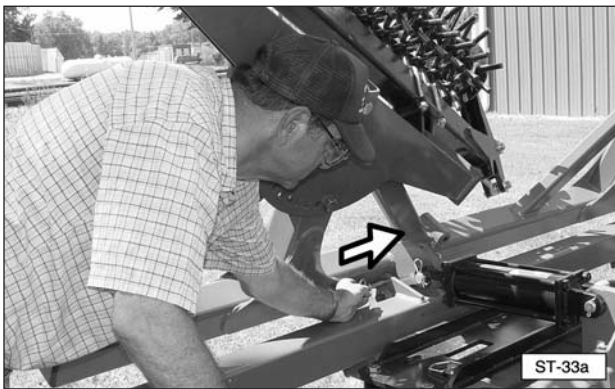

NOTICE

To avoid damage to the Smart-Till®, do not transport unless all the rotary harrow attachments are fully raised over center and transport lock pins are secured through the harrow bracket and main frame.

Operating Adjustments

⚠ WARNING



Before making any adjustments on the implement outside the tractor cab, ensure that all hydraulic levers are in the neutral position. Always shut off the tractor, set the parking brake, and remove the key before performing any operation or service.

Tine Gang Adjustments

NOTICE

Check all Tine Gang C-flex upper and lower mounting bolts after ten hours of field operation. Tighten bolts to 250 ft lb (339 N·m). Operating the Smart-Till® with improperly tightened bolts can cause bolt or C-flex failure.

NOTE: For more information on Tine Gang C-flex maintenance, refer to the Service Procedures section in this manual.

Each tine gang angle of attack is adjustable from 0° (neutral) to 10° (aggressive). The tine gang angle can be adjusted in 2.5° increments by utilizing front and rear pin slots (A) in the tine gang carriage plates. To increase soil disturbance, increase the tine gang angle of attack.

NOTE: Smart-Till® Model SMT303 shown. Other models are similar.

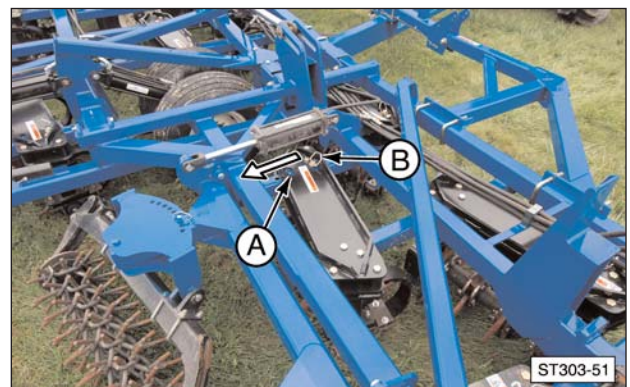

(A) Tine Gang Locator Plate Pin Slots. (B) Lock Pin.

NOTICE

Operating the Smart-Till® with tine gangs at different angles can adversely affect the way the implement tracks and puts extra strain on the implement and tractor. Make sure all gangs are set to the same angle.

Tine gang adjustments must be made with the implement properly hitched to a tractor, side wings and rotary harrows in field position (if equipped), and transport wheels lowered (extended) with the wheel transport locks installed.

NOTE: For more information on operating the Smart-Till® hydraulic systems, refer to the appropriate Operation section in this manual.

1. Shut off the tractor, place the hydraulic levers in neutral, and set the parking brake. Remove the hitch-clip from the tine gang lock pin and remove the lock pin.
2. Carefully slide (pivot) the tine gang to the desired angle setting. Line up the appropriate (front or rear) pin slot with the desired main frame hole.

NOTE: It may be necessary to use a pry bar to help move the tine gang to a new position.

3. Reinstall the lock pin and secure with the hitch-clip.
4. Repeat the adjustment procedure for each tine gang.

NOTE: For more information on applicable tine gang angles, refer to the Tine Gang Settings and Recommended Speed Chart in the Operating Speed section of this manual.

NOTE: Make sure all tine gangs are set to the same angle.

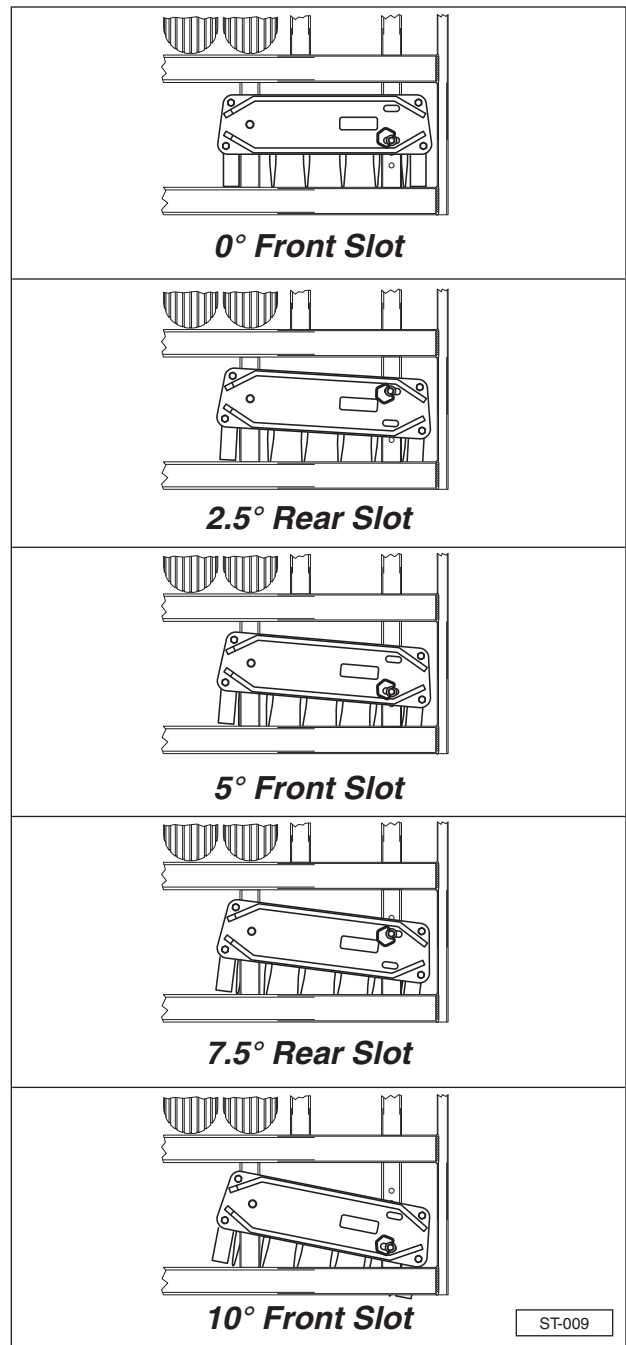

Operating Speed

⚠ WARNING



To avoid personal injury or death, carefully read and understand all instructions before attempting to assemble, operate, or maintain the Smart-Till®. Do not operate or work on a implement unless you read and understand the instructions and warnings in this and all other applicable manuals. Contact HCC if any of the instructions provided are unclear or not understood. Proper care is your responsibility. Always follow all State and Federal health and safety laws and/or local regulations.

For the best results, the Smart-Till® must be operated at a speed appropriate to the soil conditions and the desired tillage.

NOTICE

To help prevent damage to the Smart-Till®, slower working speeds are recommended in fields with obstacles, such as large rocks or fire ant mounds.

Tine Gang Settings/Speed Chart

- At lower tine gang angles (0 to 5°), the implement will aerate the soil and perform light fracturing at speeds of 6 mph or less.



- At higher tine gang angles (7.5 to 10°), the shattering action moves deeper to give better fractionation through the soil profile. The implement needs to be operated at a minimum speed of 7 mph or faster.



Smart-Till® Recommended Tine Gang Settings/Speed Chart

Tine Gang Angle ¹	Speed	Desired Effect	Farm Practices
2.5°	4-10 mph (7-16 kp/h)	Pure Aeration	Alfalfa, Hay, and Pasture
2.5°	4-10 mph (7-16 kp/h)	Minimal Disturbance	Corn and Soybeans
5°	7-10 mph (11-16 kp/h)	Light Surface Disturbance	Primary Tillage
7.5°	7-10 mph (11-16 kp/h)	Maximum Fracturing	All Crops Except Hay and Forage
10°	7-10 mph (11-16 kp/h)		Corn With Corn Residue Heavy Residue Crops

¹ In grass and alfalfa, start at 2.5° and adjust accordingly. In tillage conditions, start at 5° and adjust accordingly.

Rotary Harrow Adjustments

If equipped with the optional rotary harrow attachments, the harrow angle can be adjusted from 30° standard to 30° aggressive, in 7.5° increments.

NOTE: Smart-Till® Model SMT151 shown. Other models are similar.



0 Degree Setting Shown.

When looking at the rotary harrow from behind the implement, a setting of 0° to 30° standard positions the rotary harrow chain fingers **entering the soil** at an angle **against** the direction of implement travel.

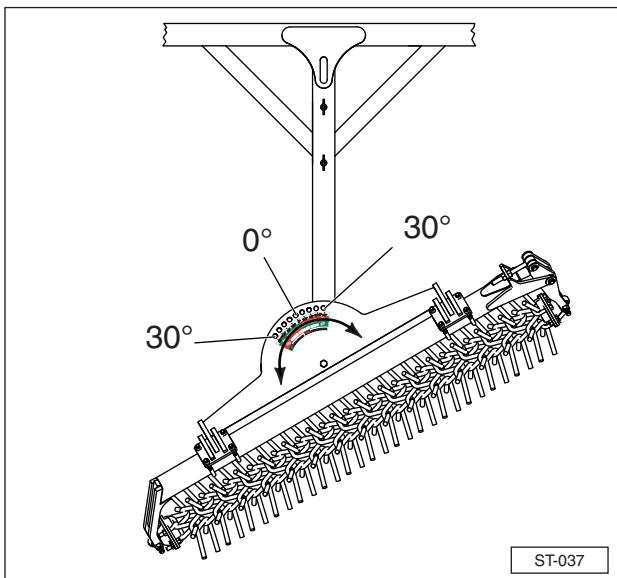

30 Degree Standard Setting Shown.

When looking at the rotary harrow from behind the implement, a setting of 0° to 30° aggressive positions the rotary harrow chain fingers **entering the soil** at an angle **towards** the direction of implement travel.

NOTE: Smart-Till® Model SMT151 shown. Other models are similar.



30 Degree Aggressive Setting Shown.

NOTE: The position of the rotary harrow gang tension adjuster does not effect rotary harrow operation. The tension adjuster can be at either end of the rotary harrow frame in relation to the angle of the rotary harrow fingers.

The higher angle settings of 15° to 30° are best used in very light residue, clean ground, and/or when secondary tillage is desired.

To prevent soil ridges or fluffing in heavy residue, do not set the harrow angle above the 15° aggressive setting. In pasture, hay, and alfalfa a setting of 0° to 15° standard is very effective for aeration without surface tillage.

NOTICE

To help prevent wear or damage, make sure rotary harrow chains are set to the recommended tension. For more information, refer to the Maintenance section in this manual.

NOTE: For more information on adjusting the rotary harrows, refer to the Step by Step instructions following the Rotary Harrow Orientation Charts in this section.

Rotary Harrow Orientation Charts

0° to 30° Standard: Rotary harrow fingers **entering the soil** are at an angle **against** the direction of implement travel.

0° to 30° Aggressive: Rotary harrow fingers **entering the soil** are at an angle **towards** the direction of implement travel.

SMT101 Dual Gang Center Section

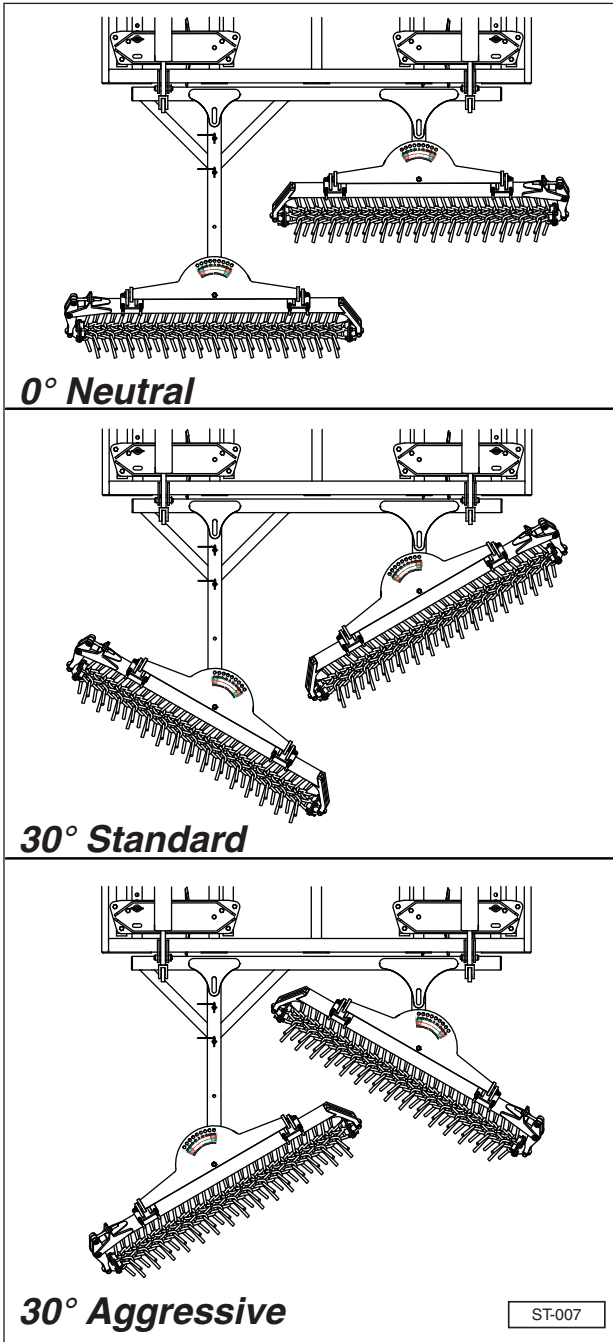

SMT151, SMT203, and SMT303 Triple Gang Center Section

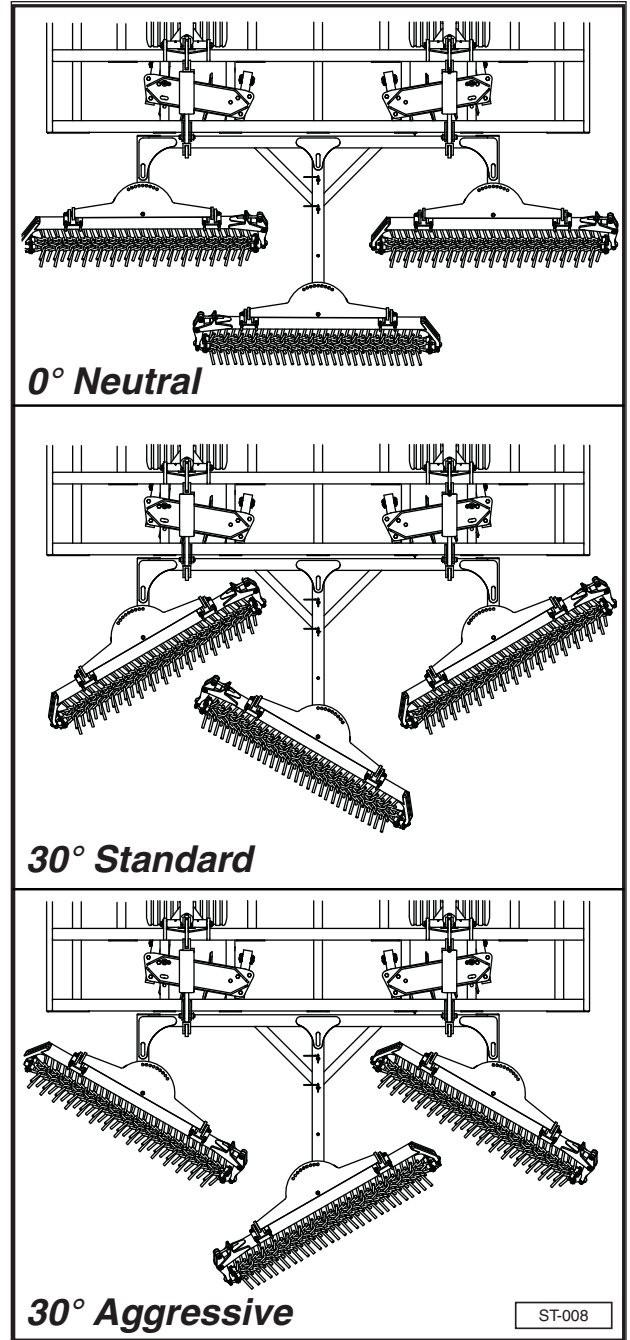

SMT203 Single Gang Side Wing Section

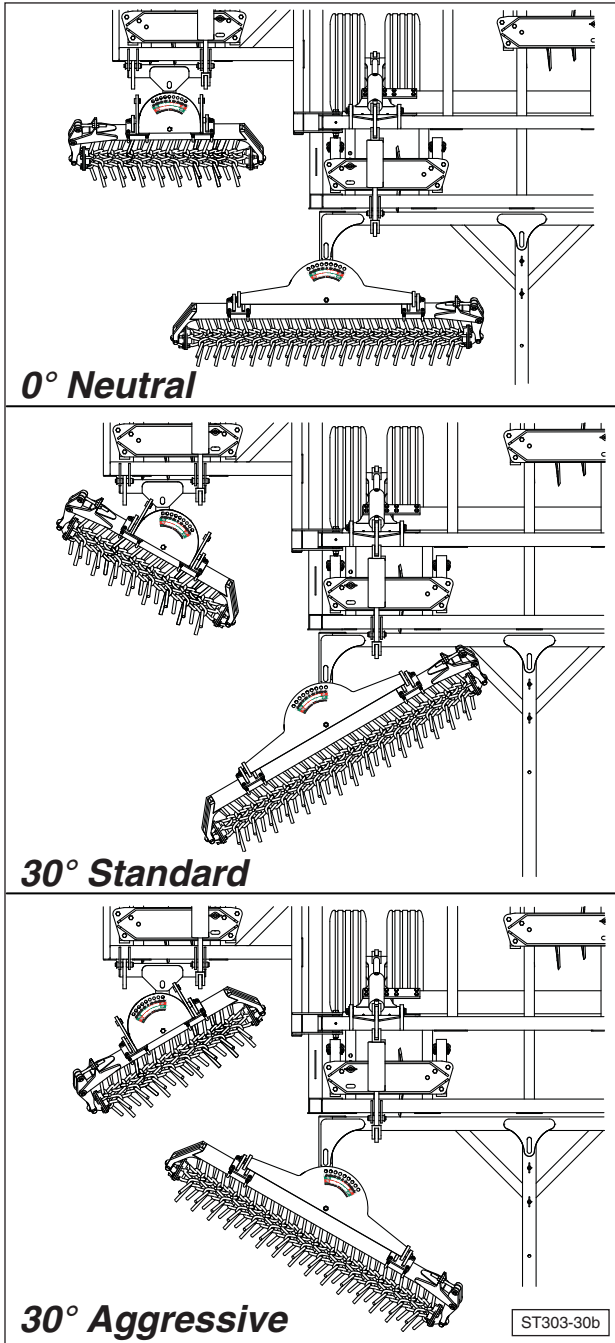

Left Side Rotary Harrow Wing Shown.

NOTE: On SMT203 rotary harrow side wings, always orient the short side wing rotary harrow gang in the opposite direction from the center section rotary harrow gang adjacent to it.

SMT303 Dual Gang Side Wing Section

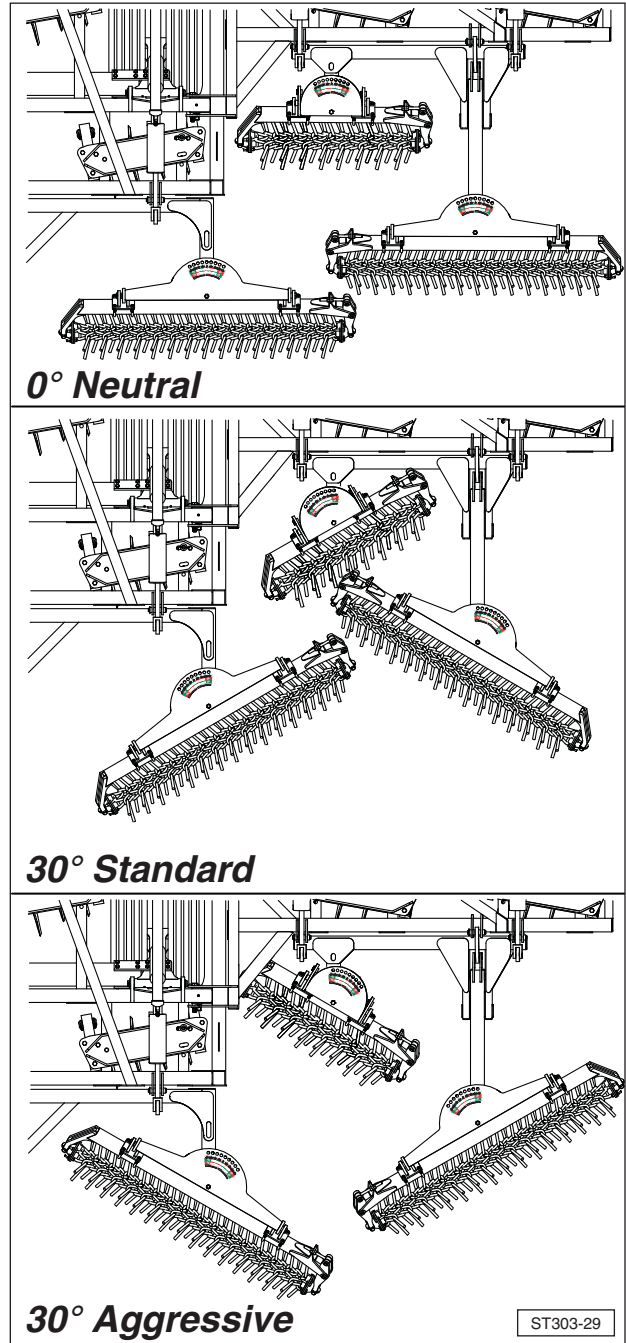

Right Side Rotary Harrow Wing Shown.

NOTE: On SMT303 rotary harrow side wings, always orient the short side wing rotary harrow gang in the same direction as the center section rotary harrow gang adjacent to it.

Rotary harrow adjustments must be made with the implement properly hitched to a tractor, side wings (if equipped) and rotary harrows unfolded, and transport wheels extended with the wheel transport locks installed.

1. Shut off the tractor, place the hydraulic levers in neutral, and set the parking brake. Adjust the rotary harrow angle.
 - a. On a rotary harrow gang adjustment plate, remove hairpin clip and front adjustment pin (A).
 - b. If necessary to swivel the adjustment plate, loosen rear attachment bolt and lock nut (B).
 - c. Reinstall adjustment pin and hairpin clip (A) in the new location. If loosened in Step 1b, securely tighten bolt and nut (B).

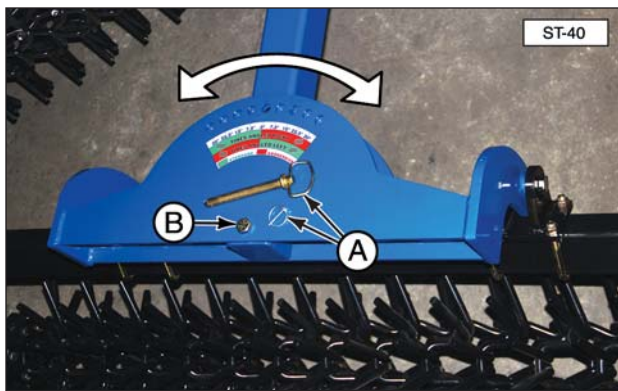

2. Repeat this process for all other rotary harrow gangs.



Maintenance

WARNING



To avoid personal injury or death, carefully read and understand all instructions before attempting to assemble, operate, or maintain the Smart-Till®. Do not operate or work on a implement unless you read and understand the instructions and warnings in this and all other applicable manuals. Contact HCC if any of the instructions provided are unclear or not understood. Proper care is your responsibility. Always follow all State and Federal health and safety laws and/or local regulations.



When working on the Smart-Till® in the raised position, always install wheel transport locks and position four or more suitable support stands under the implement frame. Use additional stands under side wings, if equipped. Inadequate support stands could collapse, causing serious injury or death. Make sure the stands are capable of supporting the weight of the implement.



Before making any adjustments on the implement outside the tractor cab, ensure that all hydraulic levers are in the neutral position. Always shut off the tractor, set the parking brake, and remove the key before performing any operation or service.



To avoid personal injury, never stand with feet under tines while making adjustments or during maintenance. Be extremely careful when working within the implement frame.



Tines on the Smart-Till® are sharp. To avoid injury, use caution and always wear protective gloves when working around sharp components.

NOTE: For a listing of serviceable replacement parts, refer to the C-1184 Smart-Till® Parts Manual.

Periodic Maintenance

! WARNING



To avoid personal injury or death, carefully read and understand all instructions before attempting to assemble, operate, or maintain the Smart-Till®. Do not operate or work on a implement unless you read and understand the instructions and warnings in this and all other applicable manuals. Contact HCC if any of the instructions provided are unclear or not understood. Proper care is your responsibility. Always follow all State and Federal health and safety laws and/or local regulations.

Maintenance recommendations are based on normal operating conditions. Severe or unusual conditions may require more frequent maintenance.

Daily Maintenance

Perform maintenance on the Smart-Till® before each daily use, or every ten hours of operation. Make repairs as needed.

1. Check all bolted connections, including the optional rotary harrow gangs. Ensure that all fasteners are tight, and all pins are secured in place.
2. Inspect the frame for structural fractures.
3. Make sure all warning decals are in place and legible.
4. Inspect all hydraulic hoses and fittings for leaks or signs of wear.
5. Check the Smart-Till® tines for wear and damage. If the tines are worn down to approximately 5.50 inches (13.9 cm), they must be replaced.
6. Check the optional rotary harrow tooling (if equipped) for wear and damage. Replace as required.

Note that tine gang bearings are maintenance free units hence lubrication is unnecessary

Maintenance/Lubrication Points

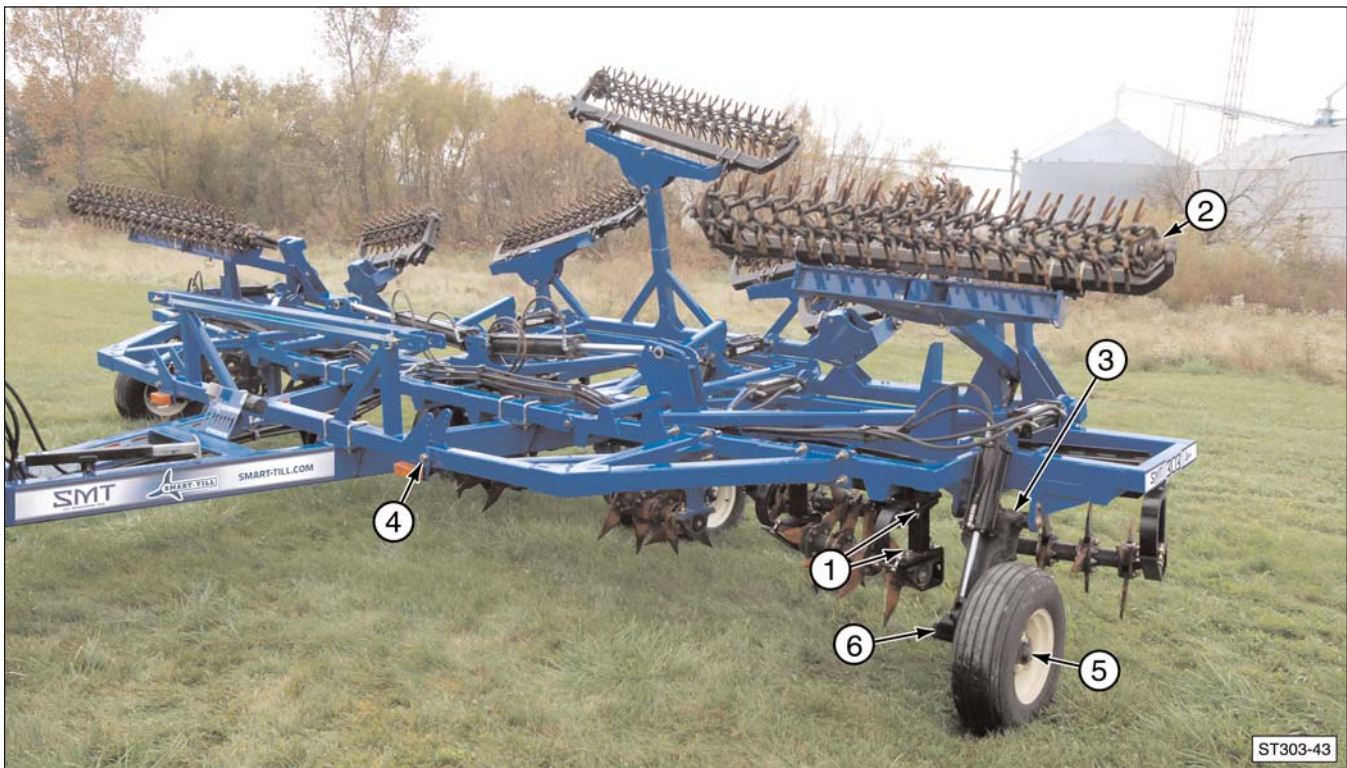

Model SMT303 Shown. Models without side wings will not have pivot Zerk fittings (4). Refer to the Maintenance/Lubrication Chart for Item, Service, Quantity, and Frequency Information.

- Lubricate the Zerk fittings on rotary harrow gang bearings (if equipped) with a good general purpose lithium grease. Fill each cavity just until resistance is felt. Do not force grease past the seals.

Weekly Maintenance

Perform maintenance on the Smart-Till® weekly, or every 50 hours of operation. Make repairs as needed.

- Perform the Daily Maintenance schedule.
- Check the tine gang bearings and rotary harrow bearings (if equipped) for signs of seal damage or excessive wear.
- Lubricate the Zerk fittings on the main frame wheel pivots with a good general purpose lithium grease.
- Lubricate the Zerk fittings on the side wing frame pivots with a good general purpose lithium grease.
- Check and adjust the tension on the optional rotary harrow gangs (if equipped). For more information, refer to the Adjust Rotary Harrow procedure in the Maintenance section of this manual.
- Check the tire pressure and set to tire manufacturer's recommended specification. Inspect the tires for wear and/or damage. Make sure the wheel lugs are torqued to 90 ft lb (122 N·m).

Yearly Maintenance

Perform maintenance on the Smart-Till® annually, or every 100 hours of operation. Make repairs as needed.

- Perform the Daily Maintenance schedule.
- Perform the Weekly Maintenance schedule.
- Lubricate the Zerk fittings on the transport wheel bearing hubs with a good quality wheel bearing grease. Fill each cavity just until resistance is felt. Do not force grease past the seals.
- Remove debris and clean the entire implement with compressed air or a pressure washer.

NOTICE

To help prevent damage to the Smart-Till®, avoid spraying air, water, steam, or cleaning solvents directly at the bearings and seals.

- To help prevent corrosion, remove rust and apply a coat of HCC blue paint to frame surfaces where the paint has been worn off or damaged.

NOTE: For more information on storing the Smart-Till®, refer to the Storage section in this manual.

Maintenance/Lubrication Chart

Maintenance/Lubrication Chart			
Item	Service To Perform	Quantity	Frequency
1	Check Tine Gang C-flex Bolt Tightness	10 Bolts Per Tine Gang	After Ten Hours of Use
2	Grease Rotary Harrow Bearings (if equipped)	4, 6, 10, or 14 Zerk Fittings	Every Ten Hours of Use or Daily
—	Inspect Hydraulic Hoses and Fittings	All	Every Ten Hours of Use or Daily
—	Inspect Frame, Pivot Points, and Welds	All	Every Ten Hours of Use or Daily
—	Check Tine and Rotary Harrow Tooling Wear	All	Every Ten Hours of Use or Daily
3	Grease Transport Wheel Pivot	4 or 8 Zerk Fittings	Every Ten Hours of Use or Weekly
4	Grease Side Wing Pivot	6 or 8 Zerk Fittings	Every Ten Hours of Use or Weekly
—	Check Fasteners For Tightness	All	At Ten Hours, Then Every 50 Hours or Weekly
5	Inspect Wheel Lug Bolts and Tires	All	At Ten Hours, Then Every 50 Hours or Weekly
—	Inspect Tine Gang/Rotary Harrow Bearings	All	Every 50 Hours of Use or Weekly
6	Grease Transport Wheel Bearing Hubs	4 or 6	Every 100 Hours of Use or Yearly
—	Remove Rust, Repair Worn or Damaged Paint	As Required	Every 100 Hours of Use or Yearly

Service Procedures

⚠ WARNING



To avoid personal injury or death, carefully read and understand all instructions before attempting to assemble, operate, or maintain the Smart-Till®. Do not operate or work on a implement unless you read and understand the instructions and warnings in this and all other applicable manuals. Contact HCC if any of the instructions provided are unclear or not understood. Proper care is your responsibility. Always follow all State and Federal health and safety laws and/or local regulations.

NOTE: For service procedures Left-Hand and Right-Hand are referenced from the back of the implement looking towards the tractor.

Tine Gang C-flex Bolt Torque Settings

NOTICE

The recommended torque for the C-flex bolts is 250 ft lb (339 N·m). Operating the Smart-Till® with improperly tightened bolts can cause bolt or C-flex failure.

1. Check all C-flex upper and lower mounting bolts after ten hours of field operation. Tighten bolts to 250 ft lb (339 N·m).
 - a. With the implement properly hitched to a tractor, activate the hydraulic system to lower (extend) the wheels and raise the implement to the transport position. Install the transport supports and lock pins.
 - b. Activate the hydraulic system to unfold (extend) the side wings, if equipped. Shut off the tractor, place the hydraulic levers in neutral, and set the parking brake.

- c. Install four or more support stands under the implement frame. Use additional stands under the side wings, if equipped.
- d. Tighten upper C-flex bolts (D) to 250 ft lb (339 N·m) (four or six per tine gang).
- e. Tighten lower C-flex bolts (E) to 250 ft lb (339 N·m) (four per tine gang).

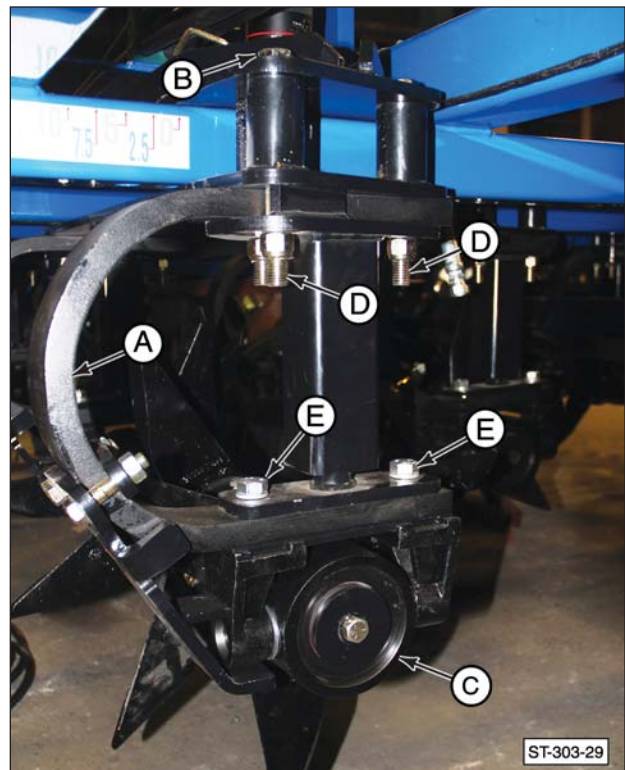

(A) C-flex Spring. (B) Carriage Plate Assembly. (C) Tine Gang Bearing. (D) Upper C-flex Bolts. (E) Lower C-flex Bolts (shown without rock guard).

Replace Tines

Tines should be replaced when damaged or when worn to approximately 5.5 inches (13.9 cm) in length. For best results when replacing worn tines, replace all three tines on each tine gang flange.

NOTICE

Tine gangs are directional and installed on the Smart-Till® in a specific pattern. If tine gangs are removed or disassembled for any reason, always mark, reassemble, and reinstall in the same orientation as removed. Improperly oriented tine gangs can cause inferior performance and shortened service life.

NOTICE

To prevent damage to the Smart-Till®, make sure all transport lock pins are removed before operating the hydraulic system.

NOTE: For more information on operating the Smart-Till® hydraulic systems, refer to the appropriate Operation section in this manual.

1. With the implement properly hitched to a tractor, activate the hydraulic system to lower (extend) the wheels and raise the implement to the transport position. Install the transport supports and lock pins.
2. Activate the hydraulic system to unfold (extend) the side wings, if equipped. Shut off the tractor, place the hydraulic levers in neutral, and set the parking brake.
3. Install four or more support stands under the implement frame. Use additional stands under the side wings, if equipped.
4. On the selected tine gang, loosen six bolts and flanged nuts securing each tine set.

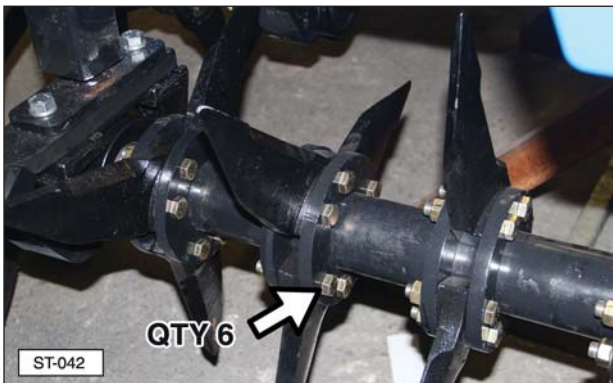

5. Remove two bolts, nuts, and the worn or damaged tine from the tine flanges.

NOTE: The use of a cutting torch may be necessary to remove tine hardware.

NOTE: Tines are directional and are marked with the letters “LF/RR” or “RF/LR”. Always replace worn tines with new tines having the same markings as those removed.

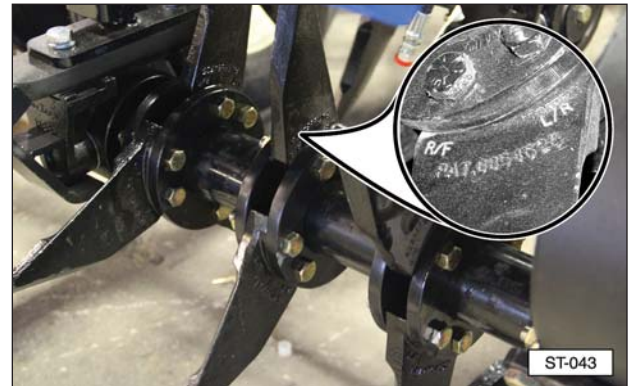

6. Install the new tine between the tine flanges, making sure it is positioned correctly.
7. Reinstall two new bolts and flanged nuts. It is not recommended to reuse original tine hardware.
8. Follow the same steps to replace the other two tines in the set, then tighten all six bolts and flange nuts to 250 ft lb (339 N·m).
9. Repeat the procedure for all tines needing replacement.

Replace Tine Gang Bearings

NOTICE

To prevent damage to the Smart-Till®, make sure all transport lock pins are removed before operating the hydraulic system.

NOTE: For more information on operating the Smart-Till® hydraulic systems, refer to the appropriate Operation section in this manual.

1. With the implement properly hitched to a tractor, activate the hydraulic system to lower the wheels and raise the implement to the transport position. Install the transport supports and lock pins.
2. Activate the hydraulic system to unfold (extend) the side wings, if equipped. Shut off the tractor, place the hydraulic levers in neutral, and set the parking brake.
3. Install four or more support stands under the implement frame. Use additional stands under the side wings, if equipped.
4. Install a ratchet strap or chain with a minimum 500 lb (227 kg) load rating securely around the tine gang shaft and upper carriage plate, as shown.

NOTE: Model SMT101 shown. Other models are similar.

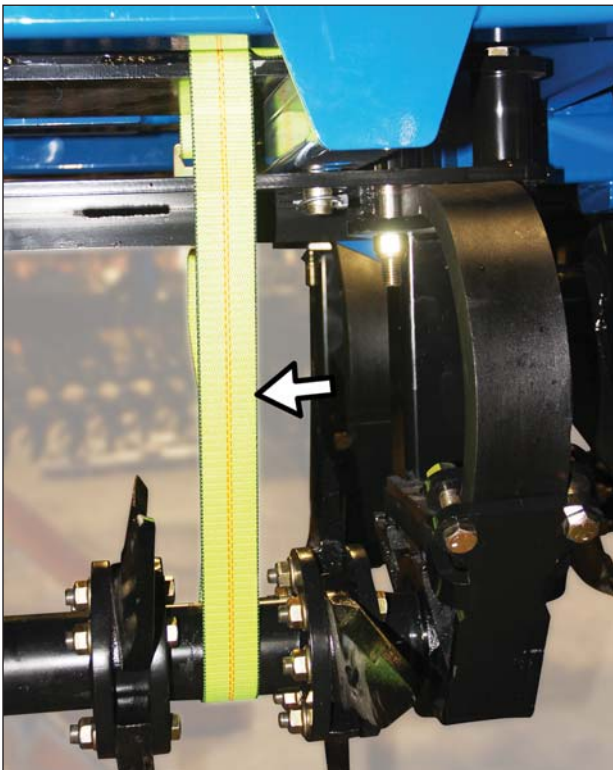

5. Adjust the tension so the tine gang shaft will be securely supported when the bearing housing is removed.

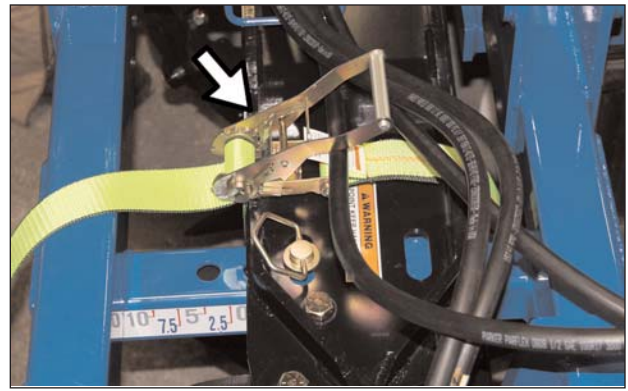

NOTICE

Tine gangs are directional and installed on the Smart-Till® in a specific pattern. If tine gangs are removed or disassembled for any reason, always mark, reassemble, and reinstall in the same orientation as removed. Improperly oriented tine gangs can cause inferior performance and shortened service life.

6. Remove the shaft end-bolt and large thrust washer. Save the bolt and thrust washer for reuse.

NOTE: The end-bolt was installed with permanent grade threadlocker. Use caution when removing the bolt to avoid damage to the shaft threads.



7. If equipped with rock guards (C), remove two bolts and nuts (A). Remove the rock guard, then remove front and rear bearing bolts with lock washers. Inspect the bolts and self-locking nuts and replace if worn or damaged.

NOTE: Model SMT303 with rock guards shown. Other models are similar.

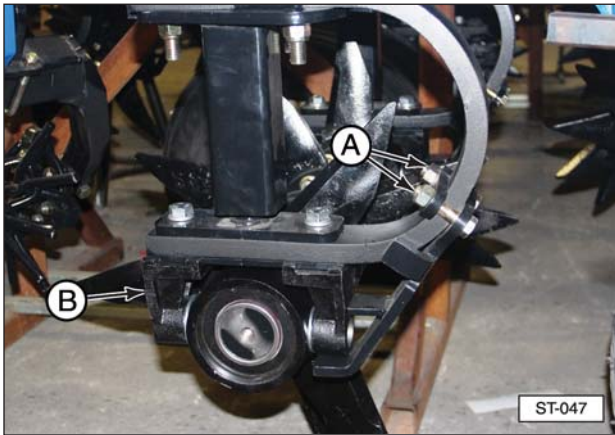

8. Clean the threads of the end-bolt and apply a small amount of permanent grade threadlocker on the threads.



9. Install the thrust washer and end-bolt on the tine gang shaft and tighten the bolt securely.

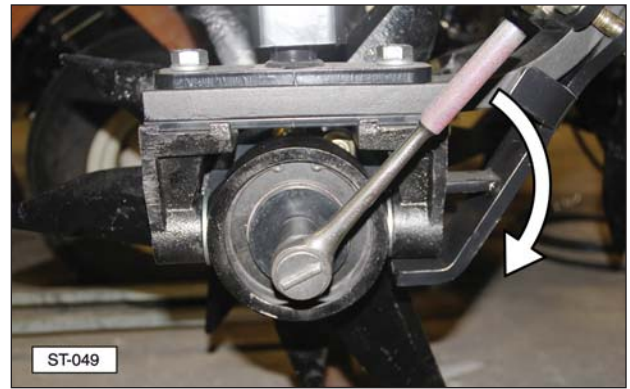

10. Torque the two bearing housing to C-flex bolts and nuts to 250 ft lb (339 N·m). Completely tighten the front rock guard bolts and nuts .

NOTICE

For best service life, always replace tine gang roller bearings in pairs.

11. Remove the support strap or chain and reinstall it at the opposite end of the tine gang. Repeat the process to replace the other tine gang bearing assembly.
12. Lubricate the Zerk fittings on tine gang bearings with a good general purpose lithium grease, until grease is visible around the bearing seals.
13. Make sure all hardware is tight, remove the tine gang support strap or chain, and verify that the tine gang rotates freely.

NOTE: After ten hours of operation, check and tighten the bearing housing to C-flex bolts and nuts to 250 ft lb (339 N·m).

Adjust Rotary Harrow Tension

If equipped with the optional rotary harrow attachment, check and adjust the tension on each rotary harrow gang. For best results, each rotary harrow chain must be tight while still rolling with slight resistance.



NOTICE

To prevent damage to the Smart-Till®, make sure all transport lock pins are removed before operating the hydraulic system.

1. With the implement properly hitched to a tractor, activate the hydraulic system to lower the wheels and raise the implement to the transport position. Install the transport supports and lock pins around the wheel cylinders.
2. Activate the hydraulic system to unfold (extend) the side wings, if equipped.
3. Activate the hydraulic system to unfold and lower the rotary harrow to the field position. Shut off the tractor, place the hydraulic levers in neutral, and set the parking brake.
4. Install four or more support stands under the implement frame. Use additional stands under the side wings, if equipped.
5. Lubricate the Zerk fittings on the rotary harrow bearings with a good general purpose lithium grease. Fill each cavity just until resistance is felt. Do not force grease past the seals.

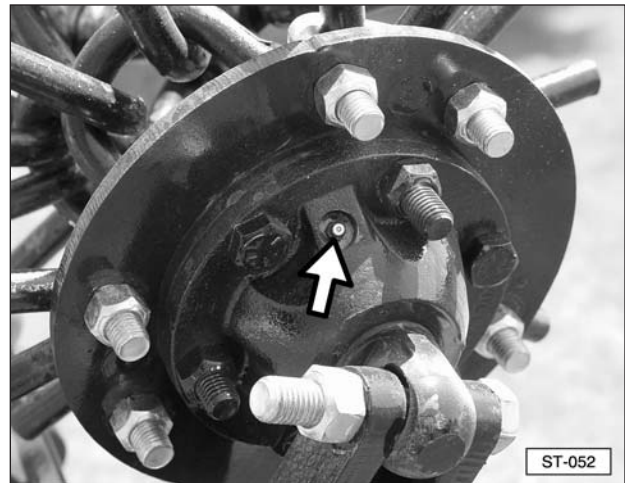

NOTICE

Check for worn or damaged rotary harrow bearings during the lubrication process. Bad bearings can increase rotation resistance. Replace any worn or damaged bearings before adjusting rotary harrow tension.

6. Check the rotary harrow tension by rotating each rotary harrow chain by hand.



7. If the harrow chain seems loose or appears to sag in the center, increase the harrow chain tension.
 - a. Loosen lock nut (A) on threaded tension rod (C).
 - b. Slowly tighten tension nut (B) on threaded tension rod (C) while rotating the harrow chain by hand.
 - c. Tighten tension nut (B) until slight resistance is felt when rotating the chain.

- d. Securely tighten self-locking nut (A) against tension nut (B) to lock tension rod (C) in position.

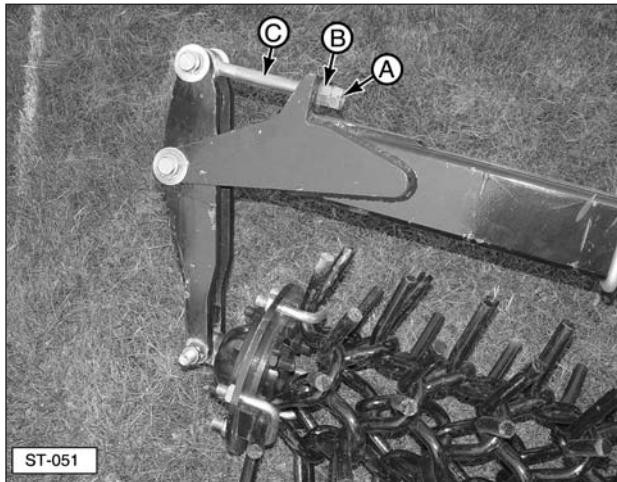

- (A) Rotary Harrow Gang Lock Nut.
- (B) Rotary Harrow Gang Tension Nut.
- (C) Rotary Harrow Gang Tension Rod.

8. If the harrow chain rotation resistance is excessive, decrease the harrow chain tension.
 - a. Loosen lock nut (A) on threaded tension rod (C).
 - b. Slowly loosen tension nut (B) on threaded tension rod (C) while rotating the harrow chain by hand.
 - c. Loosen tension nut (B) until slight resistance is felt when rotating the chain.
 - d. Securely tighten self-locking nut (A) against tension nut (B) to lock tension rod (C) in position.
9. Repeat the process for all other rotary harrow gangs.

NOTICE

After adjustments, rotate the rotary harrow chain to make sure the threaded ends of U-bolts (A) do not contact the inside of adjustable end bracket (B).

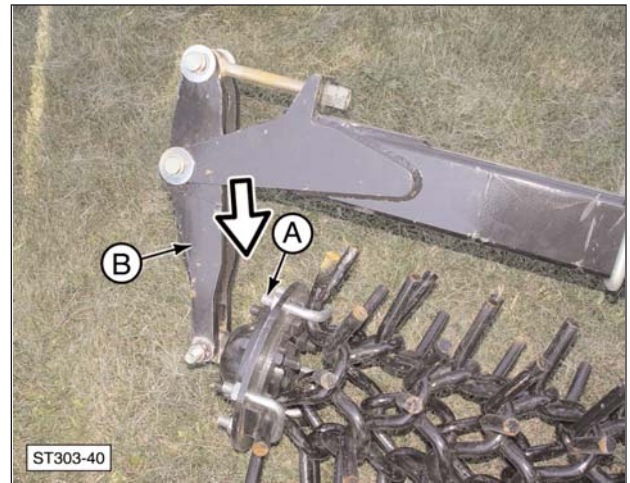

- (A) Rotary Harrow Gang U-bolt.
- (B) Rotary Harrow Adjustment End Bracket.

NOTE: Rotary harrow chains that are stretched beyond further adjustment can be shortened by removing one set of chain links. For more information, refer to the Replace Rotary Harrow Chain Links section in this manual.

Replace Rotary Harrow Chain Links

If equipped with the optional rotary harrow attachment(s), use the following steps to replace worn or damaged rotary harrow links or shorten stretched rotary harrow chains.

NOTICE

To avoid complete chain unlinking, the rotary harrow chain gang must be removed and suspended vertically, before releasing tension on the chain links.

NOTE: For more information on operating the Smart-Till® hydraulic systems, refer to the appropriate Operation section in this manual.

NOTICE

To prevent damage to the Smart-Till®, make sure all transport lock pins are removed before operating the hydraulic system.

1. With the implement properly hitched to a tractor, activate the hydraulic system to unfold the side wings, if equipped. Unfold the rotary harrows, and lower the implement to the field position.
2. Shut off the tractor, place the hydraulic levers in neutral, and set the parking brake.

⚠ DANGER



Before removing the rotary harrow gang, make sure the overhead lifting device has adequate capacity. Follow all safety recommendations when lifting the rotary harrow gang. Each harrow gang can weigh in excess of 500 lb (227 kg) and will result in serious injury or death if not adequately supported during link replacement.

3. With the rotary harrow gang supported, remove two self-locking nuts (A) and pivot bolts (B) and remove the gang from the Smart-Till® rotary harrow adjustment frame.

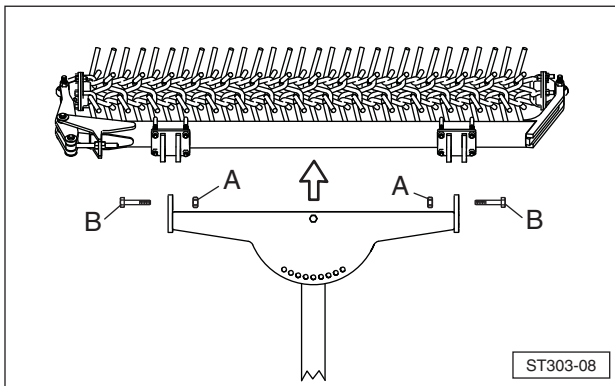

- (A) Rotary Harrow Gang Self-Locking Nut.
 (B) Rotary Harrow Gang Mounting Bolt.

4. The rotary harrow gang weighs approximately 500 lb (227 kg). Use heavy chain and a suitable lifting device to raise the rotary harrow gang at pivot bolt (E) on the adjustment end frame. Raise the rotary harrow gang until it is hanging just off the ground, as shown.

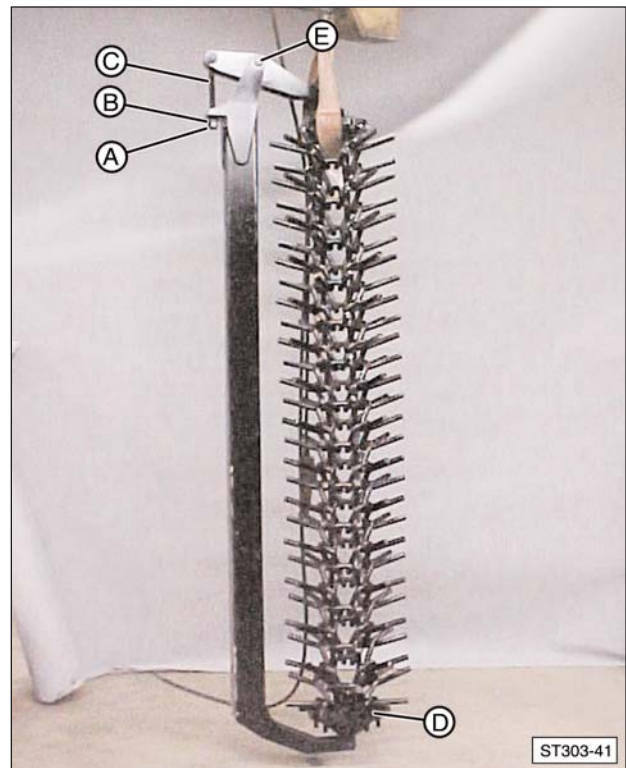

- (A) Rotary Harrow Gang Lock Nut.
 (B) Rotary Harrow Gang Tension Nut.
 (C) Rotary Harrow Gang Tension Rod.
 (D) Rotary Harrow Gang U-bolts.
 (E) Rotary Harrow Gang Pivot Bolt.

5. Release tension on the rotary harrow chain.
 - a. Loosen and remove lock nut (A) on threaded tension rod (C).
 - b. Loosen, but do not remove tension nut (B) on threaded tension rod (C).
6. With tension on the harrow chain released, remove U-bolt hardware (D) securing the end chain links at the lower end of the harrow chain.
7. Carefully unlink the rotary harrow chain from the bottom up to remove damaged or worn links.
8. Install new links as needed. Make sure to relink the chain exactly as it was prior to disassembly.

NOTE: If shortening of the rotary harrow chain is desired, remove the four bottom links, rotate the U-bolt hub to line up with the next set of chain links, and reinstall the U-bolts.

9. Reassemble the U-bolt hardware to secure the harrow chain to the bearing hub. Tighten the hardware completely.
10. Tighten tension nut (B) on threaded tension rod (C) to apply tension to the harrow chain. Tighten lock nut (A).
11. Reinstall the rotary harrow on the Smart-Till® frame using the bolts and nuts removed in Step 3. Tighten the nuts securely.
12. Refer to Adjust Rotary Harrow Tension section in this manual for information on adjusting the harrow chain tension.

NOTICE

For best service life, proper rotary harrow chain tension must be maintained. Loose harrow chains can shorten equipment life and affect performance. For best results, each rotary harrow chain must be tight while still rolling with slight resistance.

Transport Wheel Service

! WARNING



When working on the Smart-Till® in the raised position, always install wheel transport locks and position four or more suitable support stands under the implement frame. Use additional stands under side wings, if equipped. Inadequate support stands could collapse, causing serious injury or death. Make sure the stands are capable of supporting the weight of the implement.



Do not remove more than one wheel assembly from all tandem wheel assemblies on the Smart-Till® at one time. This can cause an unstable condition and can result in serious injury or death.

NOTICE

To prevent damage to the Smart-Till®, make sure all transport lock pins are removed before operating the hydraulic system.

Tandem Wheel Service

NOTE: For more information on operating the Smart-Till® hydraulic system, refer to the appropriate Operation section in this manual.

1. Properly hitch the implement to a tractor and connect all the hydraulic hoses. If equipped with side wings, remove the transport lock pins and activate the hydraulic system to unfold the side wings.
2. Remove the transport wheel locks and activate the hydraulic system to lower the Smart-Till® to the field work position.
3. Place solid blocking, such as 2 x 10 inch wooden planks, under the tire in the tandem that is **NOT** being removed.



Blocking placed under a single tire will position the second tire of the tandem slightly off of the ground.

4. Activate the hydraulic system to lower the wheels and raise the implement to the transport position.
5. Shut off the tractor, place the hydraulic levers in neutral, set the parking brake, and install the transport supports and lock pins.
6. Position four or more support stands under the frame of the implement. Position additional support stands under the side wings, if equipped.

7. Remove the wheel assembly.

- a. Remove and set aside lug nuts (A) securing wheel assembly (C) to hub (B). If necessary, position blocking to prevent tire rotation while loosening the lug nuts.

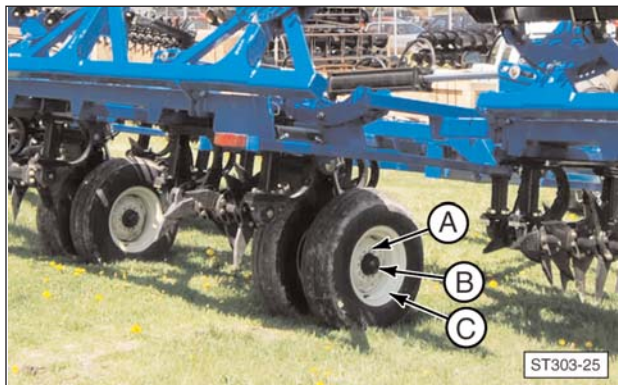

(A) Tandem Wheel Lug Nuts. (B) Tandem Wheel Hub.
(C) Tandem Wheel Assembly.

- b. The wheel assembly is heavy. If necessary, get assistance to remove the wheel assembly.

8. Install wheel assembly.

- a. Set the tire pressure to the manufacturer's recommended specification based on the weight of the implement.
- b. The wheel assembly is heavy. If necessary, get assistance to install wheel assembly (C) on wheel hub (B).
- c. Install lug nuts (A) and tighten to 90 ft lb (122 N·m). If necessary, position blocking to prevent tire rotation while tightening the lug nuts.

9. Remove the support stands positioned under the implement frame in Step 6.

10. Remove the transport supports and activate the hydraulic system to completely raise (retract) the wheels and remove the blocking installed under the tire in Step 3.

NOTE: Recheck the tire pressure and lug nut torque after ten hours of operation.

Side Wing Wheel Service

NOTE: For more information on operating the Smart-Till® hydraulic system, refer to the appropriate Operation section in this manual.

1. Properly hitch the implement to a tractor and connect all hydraulic hoses. Remove the transport lock pins and activate the hydraulic system to unfold the side wings.
2. If equipped with rotary harrows, remove the transport lock pins and unfold the rotary harrows.
3. Activate the hydraulic system to completely raise (retract) the wheels and lower the implement to the field work position.
4. Remove the side wing wheel assembly.
 - a. Remove and set aside lug nuts (A) securing wheel assembly (C) to hub (B). If necessary, position blocking to prevent tire rotation while loosening the lug nuts.
 - b. The wheel assembly is heavy. If necessary, get assistance to remove the wheel assembly.

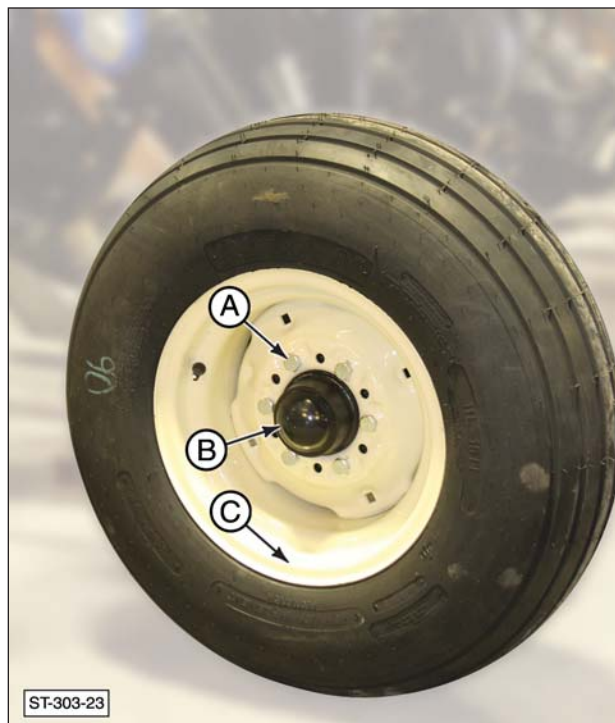

(A) Side Wing Wheel Lug Nuts. (B) Side Wing Wheel Hub. (C) Side Wing Wheel Assembly.

5. Install the side wing wheel assembly.
 - a. Set the tire pressure to the manufacturer's recommended specification based on the weight of the implement.
 - b. The wheel assembly is heavy. If necessary, get assistance to install wheel assembly (C) on wheel hub (B).
 - c. Install lug nuts (A) and tighten to 90 ft lb (122 N·m). If necessary, position blocking to prevent tire rotation while tightening the lug nuts.

NOTE: Recheck the tire pressure and lug nut torque after ten hours of operation.

Storage

For best results, always store the Smart-Till® in a dry, protected location. Leaving this implement unprotected will shorten the service life.

Prepare For Storage

After Smart-Till® field work is completed for a season, perform the following maintenance procedures before storing the implement.

1. Inspect the Smart-Till®.
 - Check all bolted connections, including the optional rotary harrow (if equipped). Ensure that the fasteners are tight, and all pins are secured in place.
 - Check the tire pressure and set to the tire manufacturer's recommended specification. Inspect the tires for wear and/or damage. Make sure the wheel lugs are torqued to 90 ft lb (122 N·m).
 - Make sure all the running lights are operational.
 - Inspect the frame for structure fractures and inspect the side wing pivot points for wear or damage.
 - Check all the bearings for signs of seal damage or excessive wear.
 - Inspect all the hydraulic hoses and fittings for leaks or signs of wear.
- Check the Smart-Till® tines for wear and damage. If any tines are worn down to approximately 5.50 inches (13.9 cm), they must be replaced.
- Check the rotary harrow chains (if equipped) for wear and damage.
- Make sure all the warning decals are in place and legible. Order any replacement decals needed.
2. Remove debris and clean the entire implement with compressed air or pressure washer.

NOTICE

To help prevent damage, avoid spraying air, water, steam, or cleaning solvents directly at the bearings and seals.

NOTE: The tine gang bearings are maintenance free and therefore do not require lubrication.

3. Lubricate the Zerk fittings on rotary harrow gang bearings (if equipped) with a good general purpose lithium grease. Fill each cavity just until resistance is felt. Do not force grease past the seals.
4. Lubricate the main frame wheel pivots and side wing pivots with a good general purpose lithium grease.
5. Lubricate the Zerk fittings on the transport wheel bearing hubs with a good quality wheel bearing grease. Fill each cavity just until resistance is felt. Do not force grease past the seals.
6. Check and adjust the tension on the rotary harrow gangs (if equipped). For more information, refer to the Rotary Harrow Maintenance section in this manual.
7. To help prevent corrosion, remove rust and apply a coat of HCC blue paint to frame surfaces where paint has been worn off or damaged.

8. Store the implement:

- If equipped, place the rotary harrow in the transport mode, with the lock pins installed.
- Place the side wings in the transport mode, with the lock pins installed.
- Park the implement on a stable, level surface.
- Store the implement with the transport wheels extended in the transport mode and the wheel support locks installed. Block the wheels to prevent movement.
- Support the tongue in a level position with the crank-down support jack.

Remove From Storage

Prior to use each season, perform the following inspection and maintenance on the Smart-Till®.

1. Read the operator's manual to review all safety, operational, and maintenance procedures.

NOTE: Store the Smart-Till® operator's manual in the convenient storage tube located on the hydraulic hose keyhole bracket.



2. Perform any recommended maintenance that was not completed when the implement was put into storage.

NOTE: For more information on recommended maintenance, refer to the Prepare For Storage section in this manual.

3. Inspect the Smart-Till®.

- Check the tire pressure and set to the tire manufacturer's recommended specification. Inspect the tires for wear and/or damage.
- Inspect all the hydraulic hoses and fittings for leaks or signs of wear.
- Make sure all the warning decals are in place and legible. Replace any damaged or missing decals.

4. With the implement properly hitched to a tractor and all hydraulic hoses connected, locate the Smart-Till® in an area clear of overhead obstructions or power lines. Cycle the hydraulic system circuits to phase (synchronize) the hydraulic cylinders, verify proper operation, and check for leaks.

NOTE: For more information on synchronizing the hydraulic cylinders, refer to Phasing the Hydraulic System section in this manual.

Warning Decals

Warning Decal Placement

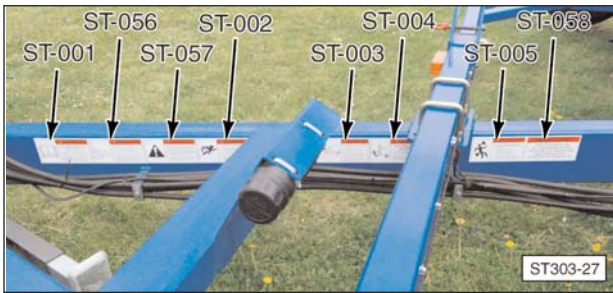

Warning Decals

Warning Decals		
Part No.	Description	Qty Required
ST-001	Read the Manual	1
ST-002	High-Pressure Fluid	1
ST-003	Electrocution Hazard	1
ST-004	Falling Wing Hazard	1
ST-005	Puncture Hazard	1
ST-056	Negative Tongue Weight	1
ST-057	Shut Off Machinery	1
ST-058	Check Hardware Torque	1
ST-059	Pinch Point Warning (large)	2 or 4 ¹
ST-059a	Pinch Point Warning (small)	4, 6, 8, or 12 ¹
275290	Harrow Adjustment	2, 3, 5, or 7 ¹
275291	Left Gang Adjustment	2, 3, 4, or 6 ¹
275292	Right Gang Adjustment	2, 3, 4, or 6 ¹
275293	Safety Kit	1
275300	SMT Tongue	2
275301	SMT101 Frame	2
275302	SMT151 Frame	2
275303	SMT203 Frame	2
275304	SMT303 Frame	2

¹ Quantity varies by implement model/size.

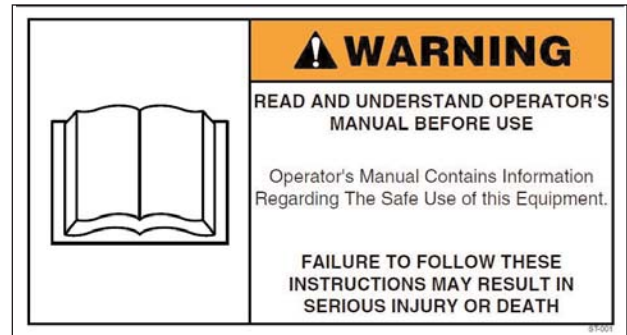

ST-001 Read the Manual

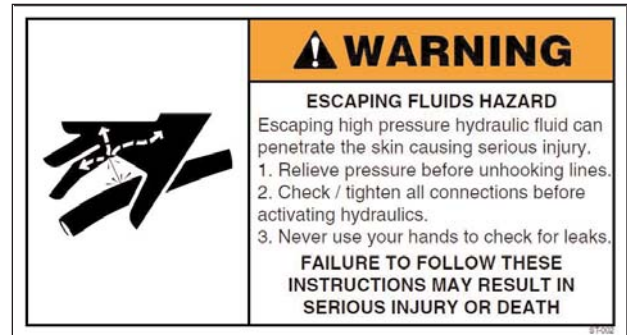

ST-002 High-Pressure Fluid

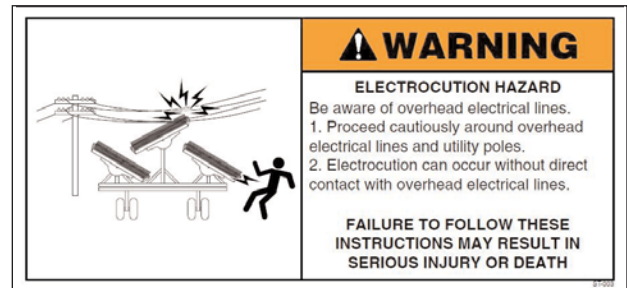

ST-003 Electrocution Hazard

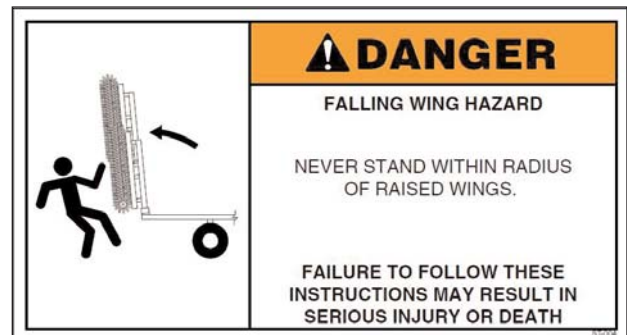

ST-004 Falling Wing Hazard



ST-005 Puncture Hazard



ST-059 Pinch Point Warning (large)

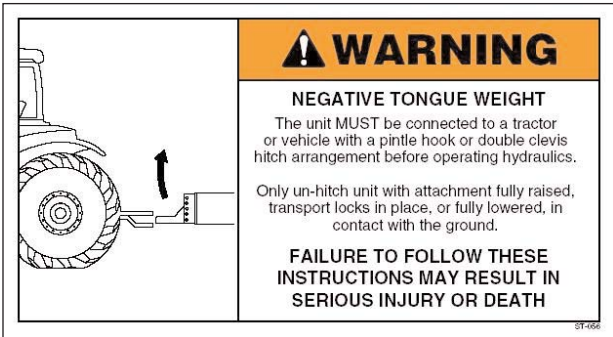

ST-056 Negative Tongue Weight



ST-059a Pinch Point Warning (small)

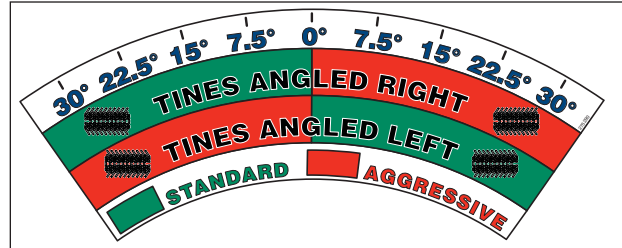

275290 Harrow Adjustment



ST-057 Shut Off Machinery

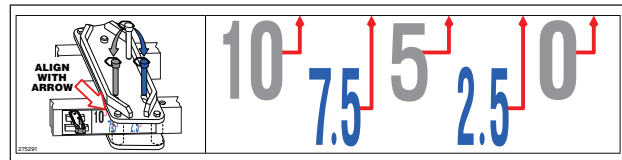

275291 Left Gang Adjustment



ST-058 Check Hardware Torque

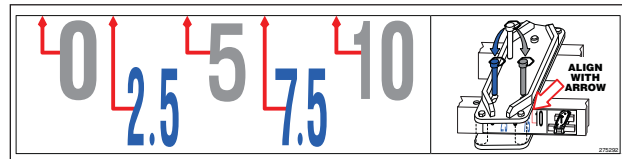

275292 Right Gang Adjustment

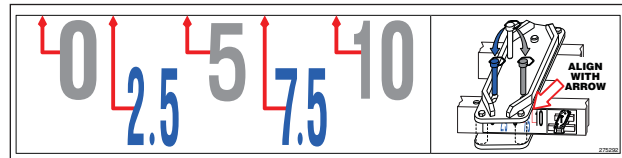

275292 Right Gang Adjustment



275300 SMT Tongue



275301 SMT101 Frame



275302 SMT151 Frame



275303 SMT203 Frame



275304 SMT303 Frame



Troubleshooting

Troubleshooting Chart		
Condition	Possible Cause	Correction
Harrow chains not rotating.	Harrow chain over-tightened.	Adjust tension.
	Harrow chain plugged with debris.	Remove debris.
	Harrow chain bearings require service.	Lubricate or replace bearings as required.
Soil ridges between harrow gangs.	Implement is not running level.	Adjust hitch to level implement.
	Harrow gang angle too aggressive.	Adjust harrow angles.
	Operating speed too high.	Reduce speed.
Plugs of soil removed from ground.	Soil conditions too wet.	Allow soil to dry out.
	Soil being worked too aggressively.	Reduce operating speed.
		Reduce tine gang angle.
Machine rocking side-to-side.	Hard ground conditions.	Adjust speed.

HCC, inc.

1501 1st Avenue – Mendota, Illinois 61342
Phone (815) 539-9371 Fax (815) 539-3135

LIMITED WARRANTY

HCC, inc. warrants each new HCC, inc. product to be free from defects in material and workmanship. This warranty is applicable only for the normal service life expectancy of the product or components, not to exceed 12 consecutive months from the date of delivery of the new HCC, inc. product to the original purchaser.

Genuine HCC, inc. replacement parts and components will be warranted for 90 days from date of purchase, or the remainder of the original equipment warranty period, whichever is longer. There is no warranty for tines.

Under no circumstances will it cover any merchandise or components thereof, which, in the opinion of the company, has been subjected to misuse, unauthorized modifications, alteration, an accident, or if repairs have been made with parts other than those obtainable through HCC, inc.

Our obligation under this warranty shall be limited to repairing or replacing, free of charge to the original purchaser, any part that, in our judgment, shall show evidence of such defect, provided further that such part shall be returned within thirty (30) days from date of failure to HCC, inc., routed through the dealer and distributor from whom the purchase was made, transportation charges prepaid.

This warranty shall not be interpreted to render HCC, inc. liable for injury or damages of any kind or nature to person or property. This warranty does not extend to the loss of crops, loss because of delay in harvesting, or any expense or loss incurred for labor, substitute machinery, rental, or for any other reason.

Except as set forth above, **HCC, inc. shall have no obligation or liability of any kind on account of any of its equipment and shall not be liable for special or consequential damages. HCC, inc. makes no other warranty, expressed or implied, and specifically, HCC, inc. disclaims any implied warranty of merchantability or fitness for a particular purpose. Some states or provinces do not permit limitations or exclusions of implied warranties or incidental or consequential damages, so the limitations or exclusion in this warranty may not apply.**

This warranty is subject to any existing conditions of supply which may directly affect our ability to obtain materials or manufacture replacement parts.

HCC, inc. reserves the right to make improvements in design or changes in specifications at any time, without incurring any obligation to owners of units previously sold.

No one is authorized to alter, modify, or enlarge this warranty nor the exclusion, limitations, and reservations.

Effective with products delivered to original user on or after January 1, 2014

Notes

Notes



**1501 1st Avenue
Mendota, IL 61342
815-539-9371
www.hccincorporated.com**

**C-1183
January 2014**