

greenworks

EN	ROBOTIC VACUUM	OPERATOR MANUAL
FR	ASPIRATEUR ROBOTIQUE	MANUEL D'OPÉRATEUR
ES	ROBOT ASPIRADOR	MANUAL DEL OPERADOR

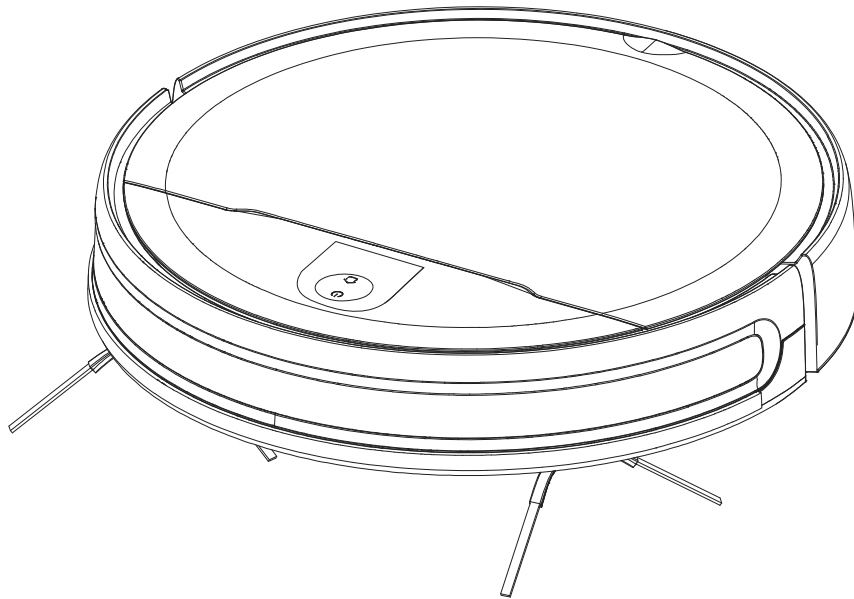

GRV-1010

www.greenworkstools.com

1	Safety Instructions.....	4	3.4	Operating the vacuum.....	9
1.1	Instructions for use.....	4	3.5	Restart the System.....	10
1.2	Safety precautions.....	4	3.6	Sound Indicators.....	10
1.3	About child safety.....	5	4	Cleaning and Maintenance.....	11
1.4	About the batteries.....	6	4.1	Clean the Dustbin.....	11
1.5	Scope of use of the product.....	6	4.2	Clean the Rolling Brush.....	12
1.6	Disclaimers.....	6	4.3	Clean the Side Brush.....	12
2	Description.....	7	4.4	Replace the Side Brush.....	13
2.1	Vacuum and dustbin.....	7	4.5	Clean the Universal Wheel.....	13
2.2	Exploded View.....	7	5	Troubleshooting.....	13
2.3	LED Indicators.....	8	6	Technical Parameters.....	14
3	Product Use.....	8	7	Environmental Statement	
3.1	Product Installation.....	8		(Optional).....	15
3.2	Charge the vacuum.....	9	8	Warranty Card.....	16
3.3	Mobile Application.....	9			

1 SAFETY INSTRUCTIONS

1.1 INSTRUCTIONS FOR USE

Please review the following basic safety precautions before using the product:

- Read the user manual carefully and follow the instructions in the user manual when using the product.
- Keep the user manual well for future reference.
- If you need to transfer the product to a third party, include the user manual with the product.
- Any operation not in conformity to the instructions in the user manual may result in serious personal injury or damage to the product itself.
- This appliance is to only be used with the power supply provided.

1.2 SAFETY PRECAUTIONS

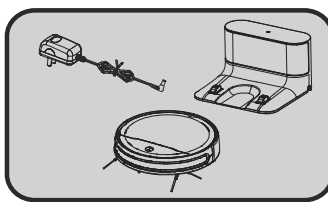
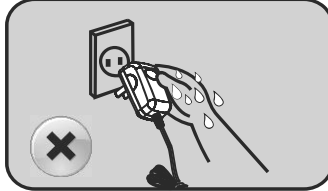
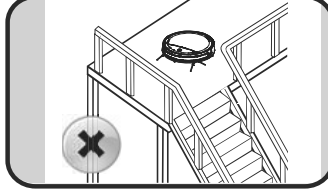
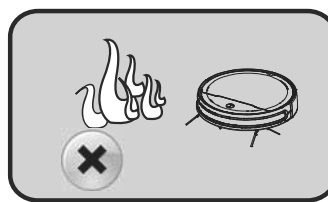
 <p>Warning</p>	
	<p>⚠ This product can only be used with the adapter, batteries and charging dock are provided with this product. Failure to do so may result in damage to the product, electrical shock, or fire caused by high voltage.</p> <p>⚠ Do not use this product if the appliance and/or accessories are found to be damaged. Contact our service department. Except for the service technicians designated or authorized by our company, no one may disassemble, repair or modify this product.</p>
	<p>⚠ Unplug the product before maintenance.</p> <p>⚠ Do not touch the power plug or the product when your hands are wet, as this may result in electrical shock.</p> <p>⚠ If the power cord is damaged, it must be replaced by the manufacturer, its service department or a similar professional.</p>
	<p>⚠ To prevent the product from falling accidentally, do not use in a suspended place without a protective fence, which may result in personal injury.</p> <p>⚠ User should not attempt to replace the batteries. Contact the manufacturer for battery replacement.</p>
	<p>⚠ Prevent clothing or any part of your body (hair, fingers, etc.) from getting caught in the brush or wheel of the vacuum cleaner. Failure to do so may result in personal injury.</p> <p>⚠ Do not place the product near fire or flammable, explosive or corrosive materials.</p> <p>⚠ If the user manual is missing, contact your local dealer or call the manufacturer's service department to obtain an electronic user manual.</p>

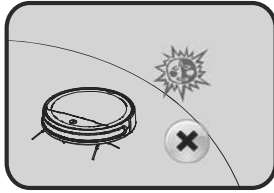
 **Caution**

This product should only be used indoors.

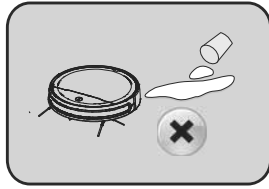

Prevent the suction of water, oil or other liquids, which may damage the vacuum cleaner.

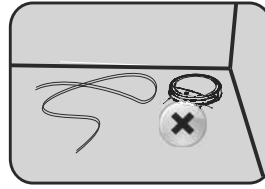

Remove scattered wires from floor before use to avoid affecting the normal operation of the vacuum cleaner.

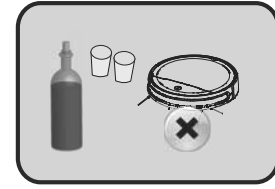

Remove fragile objects before use.

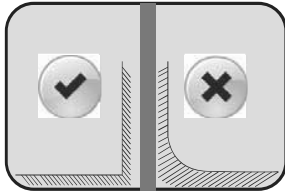

The charging dock should be placed on a flat floor by a wall to ensure proper product functionality.

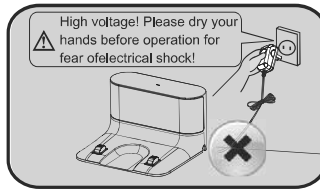

Unplug charging dock when unused for an extended period of time.

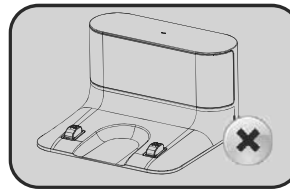

When the product is working, removal of the charging dock will affect the normal recharging of the machine.

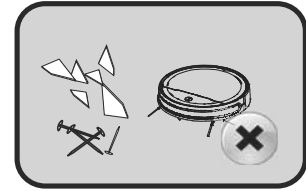

Do not use product to vacuum sharp objects (e.g., shattered glass, nails, etc.) to avoid damage to the product.

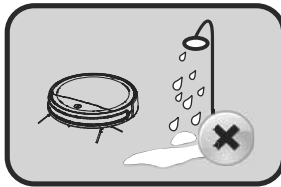

Do not use product in a wet, flammable, explosive or corrosive environment.

1.3 ABOUT CHILD SAFETY

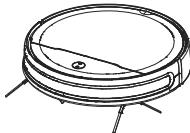

- Keep away from children! This appliance should only be used by children aged eight (8) and above and/or persons with reduced physical, sensory or mental capabilities or lack of experience and knowledge if they have been provided supervision and/or instructions concerning safe use of the appliance, and fully understand the hazards involved.
- This is not a toy. Children should not play with the appliance.
- Children should not clean or do maintenance without supervision.

1.4 ABOUT THE BATTERIES



1. Only the batteries provided by the manufacturer are applicable to the product.
2. Before discarding the product, please remove the battery as follows:
 - Use a screwdriver to loosen the screws of the side brush and the base decoration plate;
 - Remove the base plate.;
 - Take out the battery and unplug the connection cable between the battery and the vacuum.
3. Make sure that the product is powered off before removing the battery. Battery should be disposed of properly.
4. Contact manufacturer's service department for battery replacement.
5. Use of incorrect batteries may cause injury or accident.
6. If the batteries leak, prevent the contact of the liquid with the skin or clothing. Immediately wipe it with a dry cloth and send it to the recycling station or designated maintenance point. Do not discard battery.
7. The batteries contain hazardous substances harmful to the environment. Battery should be disposed of properly. Please follow the local environmental regulations and send them to the designated recycling site.



1.5 SCOPE OF USE OF THE PRODUCT

Scope of application

The product is suitable for the following floors:

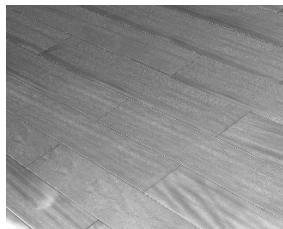

Wooden floor

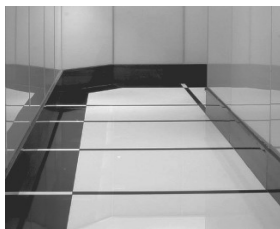

Ceramic tile

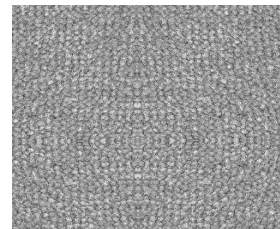

Short-staple carpet

1.6 DISCLAIMERS

Manufacturer's warranty will be null and void under any of the following circumstances:

- Damage due to the user's failure to operate the product in strict accordance with our user manual, or due to improper storage;
- The machine or parts have exceeded the free warranty period;
- Damage due to disassembly by those other than the manufacturer or maintenance personnel authorized by manufacturer.
- A valid purchase voucher number cannot be provided;
- The product model on the warranty card does not match the product to be repaired, or is altered in any way;
- Damage caused by uncontrollable factors such as natural disasters;
- Product failure or damage caused by unexpected factors or man-made causes (including operational errors, liquid ingress, improper plugging/unplugging, scratching, handling, bumping, input of inappropriate voltage, etc.)

i NOTE

Manufacturer provides a warranty for the product in accordance with the "National New Regulations on Warranty". For details, please check the warranty card provided with the product.

2 DESCRIPTION

2.1 VACCUM AND DUSTBIN

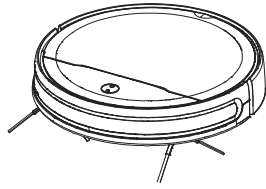

Vaccum×1

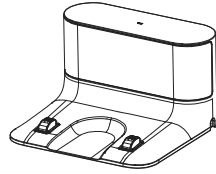

Charging Dock×1

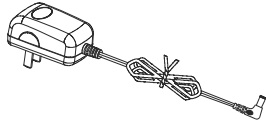

Power Adapter×1

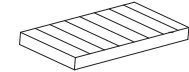

Filter Combination×1

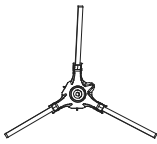
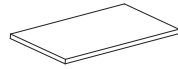

Side brush×2

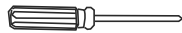

Screwdriver×1



Cleaning brush×1

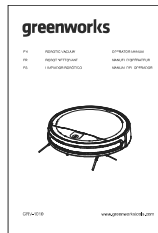





User Manual×1

Note: Accessories installed inside the vacuum are not included in the images above.

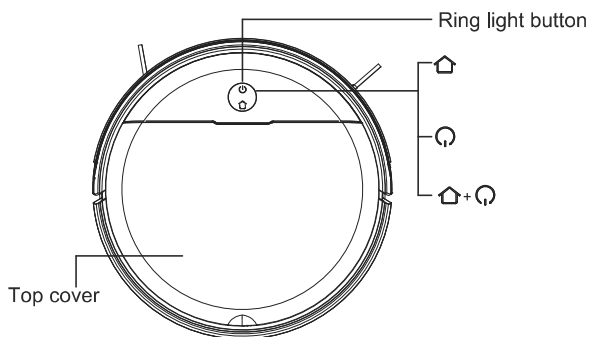
2.2 EXPLODED VIEW

A Top View



-  • Press to return to dock for charging. Press again to pause
-  • Press and hold for 3 seconds to turn on or off (only when vacuum is not being charged).
- Press to start vacuuming.
- Press to pause the task.
-  • Press and hold both buttons simultaneously for 3 seconds to reset Wi-Fi connection.

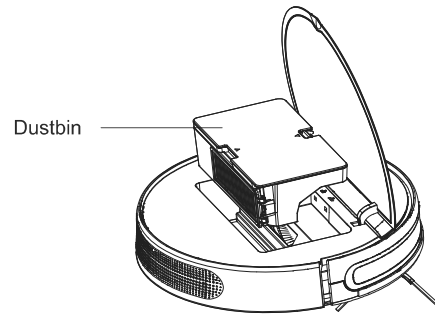
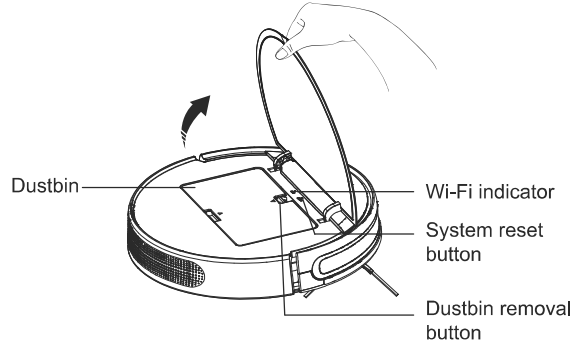

B Dustbin

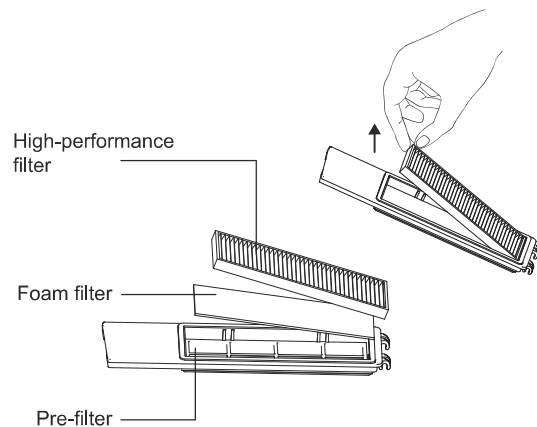
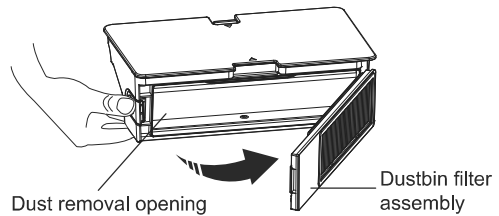

C Side View

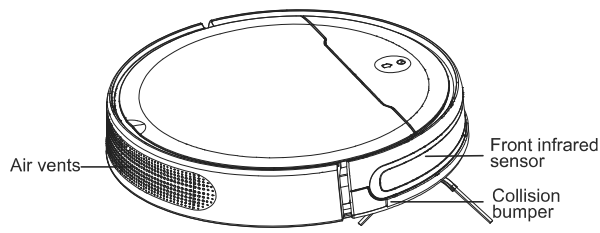

D Bottom View

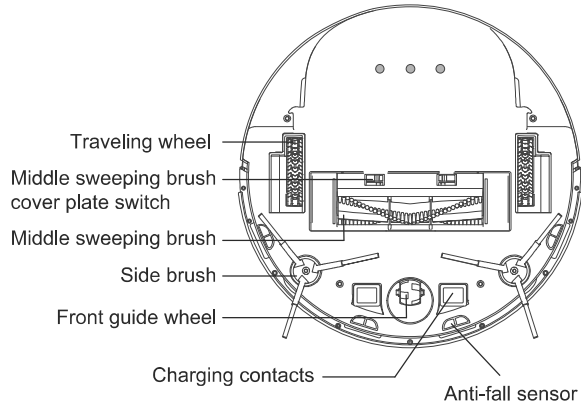

E Charging Dock

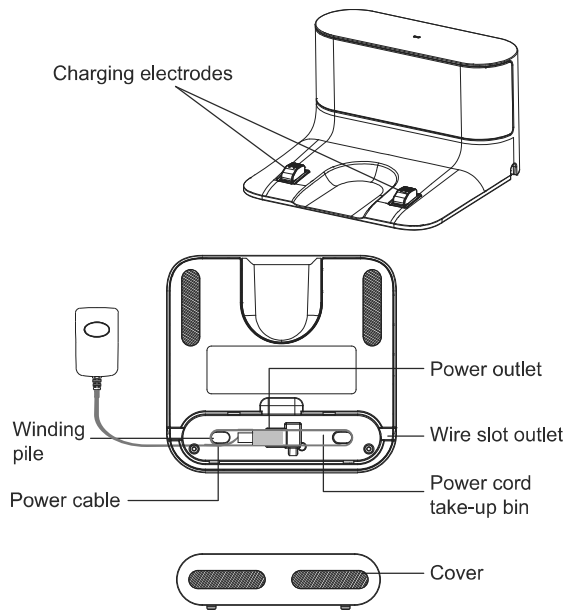

F Dust Collection Port

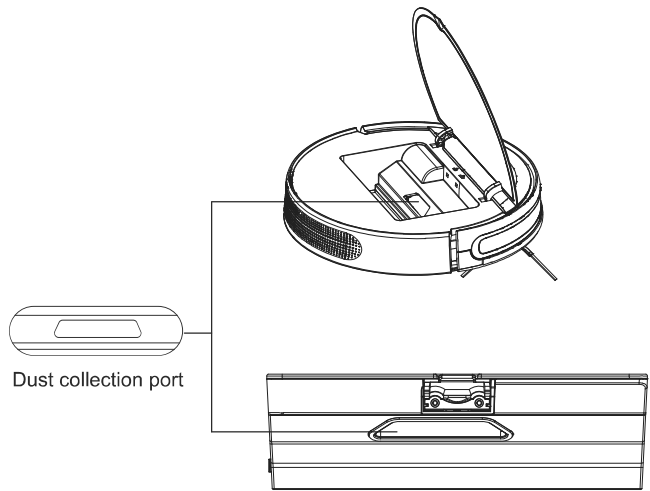

2.3 LED INDICATORS

Indicator	State
Ring lights	<ul style="list-style-type: none"> • Operation/pause: Always on in white • Recharging: Flashing in white • Charging: Blinking in white • Charging completed: Always on in white • Low battery charging: Blinking in orange • Low battery recharging/abnormal
Wi-Fi indicator	<ul style="list-style-type: none"> • During configuration: Flashing in blue • Configuration successful: Always on in blue

3 PRODUCT USE

3.1 PRODUCT INSTALLATION

A Before use, remove the foam strip beside the collision bumper.

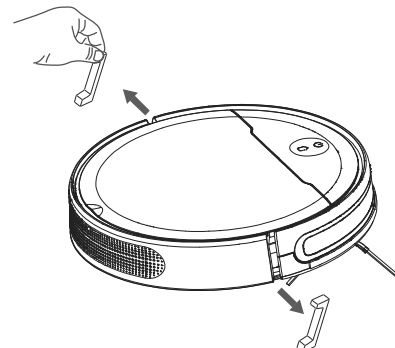

B Connect the adapter to the charging dock, and put the excess cable in the slot, as shown in the figure.

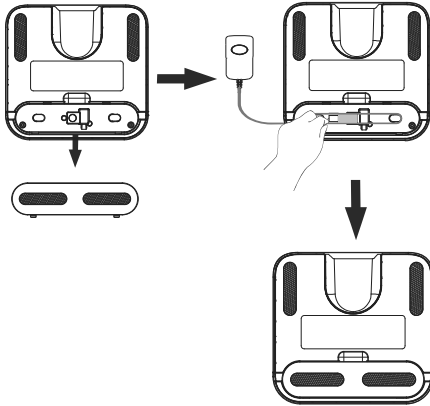

C Place the charging dock on a level surface against the wall, keep the surrounding area open.

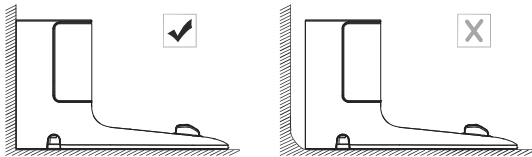

D Remove objects within 0.5 meters on the left and right sides of the charging dock and within 1.5 meters from the front. If objects cannot be removed, check to see the vacuum can return to the charging dock. If not, contact the customer service center for assistance.

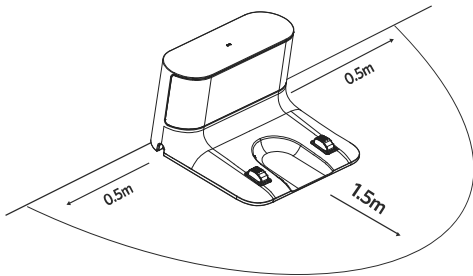

E Connect the adapter to the wall socket and keep the power on.

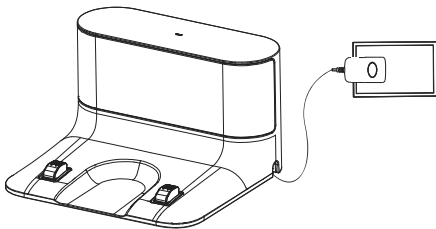

3.2 CHARGE THE VACUUM

- The vacuum is pre-installed with rechargeable batteries, which must be fully charged before use.
- The vacuum will return to the charging dock after vacuuming, or when the battery is low.

Method 1: Align the charging electrodes of the vacuum with the charging pins of the charging dock and connect to the charging dock.

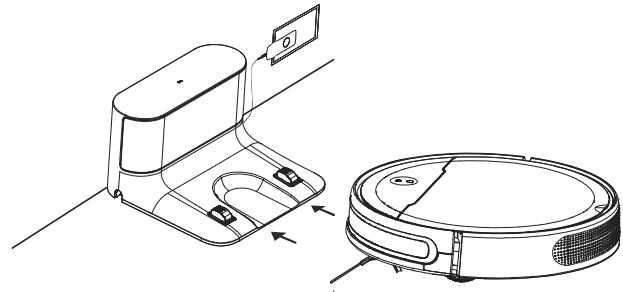

Method 2: Press “” on the vacuum to return it to the charging dock.

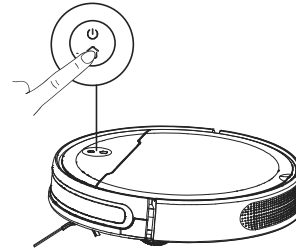

3.3 MOBILE APPLICATION

Scan the QR code and download and install the mobile application.





i NOTE

If the mobile phone cannot be connected to the robot, please refer to “Product Use” – “Reset Wi-Fi”.

3.4 OPERATING THE VACUUM



Power On/Off

- Press and hold  for 3s to turn on the machine, then the ring light will be normally on in white, the voice prompt of “Power-on” is broadcast, and the vacuum enters the standby state.
- When the vacuum is stationary, press and hold  to turn off the machine.
- The indicator goes out after power-off, and the current cleaning task ends.

i NOTE

The vacuum cannot be turned off when charging. If the vacuum cannot be turned on because the battery is too low, carry the vacuum directly to the charging dock for charging.

Vacuuming/Pause

- After power-on, press  to start cleaning.
- In the sweeping state, press  to pause.

i NOTE

The vacuum cannot be used for cleaning up liquids. If the battery is too low, vacuuming cannot be started. Charge the battery before starting sweeping. When the battery is low during sweeping, the vacuum will automatically return to the charging dock to charge. Before use, arrange wires on the floor (including the power cord for the charging dock) to prevent the vacuum from dragging the wires, causing power failure and damage to objects and/or equipment during sweeping.

Recharge/Suspended Recharging

- Automatic Mode: After operating, the vacuum will automatically return to the charging dock to charge.
- Manual Mode: press "" to start recharge.

After entering the recharging state, the ring light flashes in white (in the low battery recharging state, it flashes in orange). In the charging state, the ring light blinks in white (when the battery is low, the ring light blinks in orange). When charging is completed, the ring light is always on in white.

Modes

- Start vacuuming, and the machine will start in a random sweeping mode.

A) Vacuuming along the wall: The user uses the mobile phone app to turn on the switch of Sweeping Along the Wall, and clicks to start operation. Then the appliance will vacuum along a wall. After half an hour, the vacuuming along the wall will end, and the machine will enter the recharge mode.

B) Partial vacuuming: The user uses the mobile app to remotely control and make the vacuum move to the point to be cleaned, and clicks the vacuum switch on the remote control interface. Then the vacuum will spiral clean in a circular area with a radius of 1 meter centered on this point.

C) Quick vacuuming: The user can use the mobile app to set quick vacuuming, and the machine will vacuum in a bow-shaped path.



i NOTE

Do not use quick vacuum mode on the carpet

D) Timed vacuuming: The user can use the mobile app to set timed vacuuming, and the vacuum will start operating at the preset time and automatically return for charging after the task is completed.

Reset Wi-Fi

- If the mobile phone cannot be connected to the vacuum, or needs to connect to a new device, open the top cover to

expose the Wi-Fi indicator, then press and hold the "" button and "" button for 3 seconds, and there will be the voice prompt "Reset Wi-Fi, and enter the network configuration". Then the Wi-Fi indicator flashes, indicating that the Wi-Fi reset was successful.

Suction Adjustment

- Use the mobile app to switch between four suction modes: Quiet, Standard, Medium and Powerful. The default is the Standard mode.

Online Upgrade

- The firmware system supports online upgrades. For actual operations, follow the internal guidelines of the mobile app.

3.5 RESTART THE SYSTEM

If you press any button on the vacuum and there is no response, you can restart the system. Use a paperclip to press the restart button, and the vacuum will automatically restart.

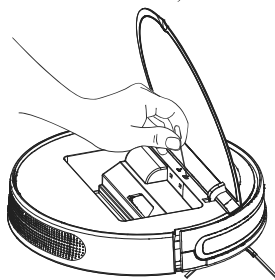

3.6 SOUND INDICATORS

Compatible with Amazon Alexa and Google Assistant

Function	Speak to	
	Alexa	Google
Turn on	Alexa, Turn on 【Vacuum name】	Ok Google, Turn on 【Vacuum name】
Turn off	Alexa, Turn off 【Vacuum name】	Ok Google, Turn off 【Vacuum name】
Smart mode	Alexa, Set 【Vacuum name】 to smart	Ok Google, Set 【Vacuum name】 to smart
Spiral mode	Alexa, Set 【Vacuum name】 to spiral	Ok Google, Set 【Vacuum name】 to spiral
Wall Follow mode	Alexa, Set 【Vacuum name】 to wall follow	Ok Google, Set 【Vacuum name】 to wall follow

Charge mode	Alexa, Set 【Vacuum name】 to dock	Ok Google, Set 【Vacuum name】 to dock
Suction : Low	Alexa, Set suction to quiet on 【Vacuum name】	Ok Google, Set suction to quiet on 【Vacuum name】
Suction : Auto	Alexa, Set suction to auto on 【Vacuum name】	Ok Google, Set suction to auto on 【Vacuum name】
Suction : High	Alexa, Set suction to strong on 【Vacuum name】	Ok Google, Set suction to strong on 【Vacuum name】
Suction : Status	Alexa, What is the suction on 【Vacuum name】 ?	/

4 CLEANING AND MAINTENANCE

Turn off the machine and unplug the adapter before cleaning and maintenance. To ensure the best performance of this equipment, follow the instructions below to clean and maintain the vacuum regularly. The frequency of cleaning/replacement depends on the use conditions of the vacuum.

RECOMMENDED CLEANING/REPLACEMENT FREQUENCY

Parts of main machine	Cleaning frequency	Replacement frequency
Dustbin	After each use	-
Filter	Once a week	Every 6 months
Rolling brush	Once a week	Every 6-12 months
Side brush	Once a month	Every 3-6 months (or when there is obvious wear)
Brush cover	Once a month	Every 3-6 months (or when the silicone strip on the brush cover is obviously worn)

Sensor	Once a month	-
Charging electrodes	Once a month	-
Universal wheel	Once a month	-

4.1 CLEAN THE DUSTBIN

A) Open the cover of the vacuum, then press the release button, and remove the dustbin.

B Take out the filter assembly.

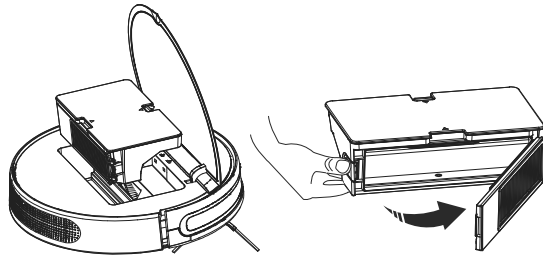

C) Take out the pre-filter, foam filter and high-performance filter.

D) Use a cleaning tool (which can be purchased separately) to brush the filters. The user can also rinse the filters thoroughly.

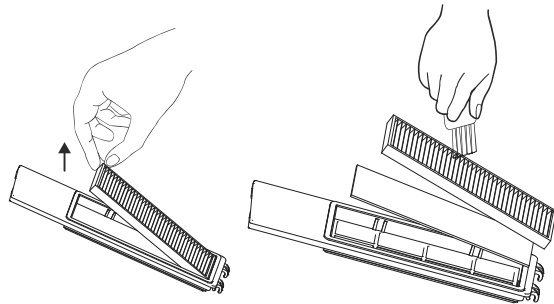

E) Press the button on the side of the dustbin, and the dustbin filter will automatically open.

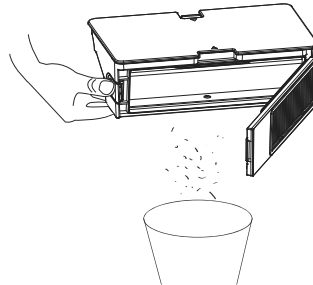

F) Empty the dustbin. Tap the dustbin gently to knock off excess dirt.

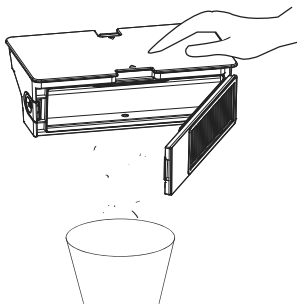

G) Rinse the dustbin and filter assembly thoroughly with water.

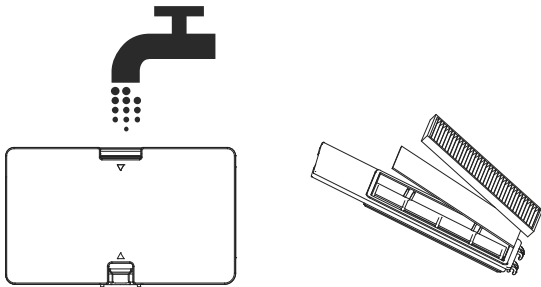

i NOTE

Do not use hot water or any detergent to clean the filter assembly.

H) Air dry the dustbin and filter assembly completely.

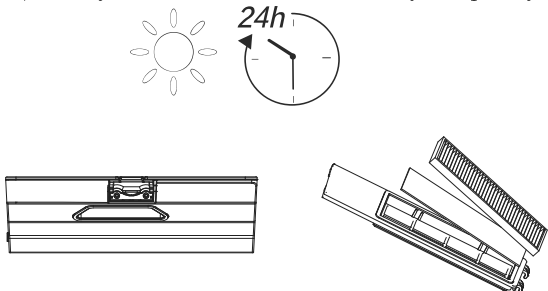

I) Return the pre-filter, foam filter and high-performance filter.

J) Put the filter assembly back into the dustbin.

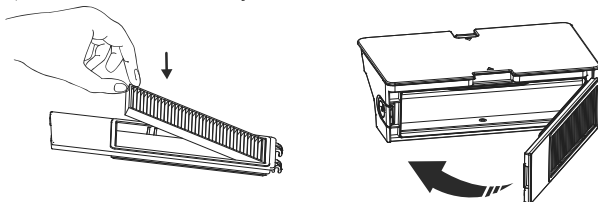

K) Put the components back into the vacuum.

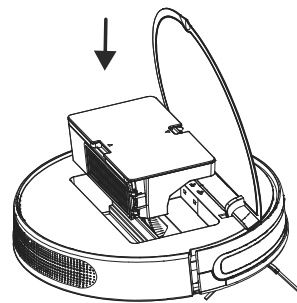

4.2 CLEAN THE ROLLING BRUSH

A) As shown in the figure, press down the clasp to take out the protective cover.

B) Remove the rolling brush by pulling upwards.

C) Use a cleaning tool (which can be purchased separately) to clean the rolling brush.

D) Put one end of the rolling brush into the corresponding hole first, and then press it down into place.

E) Press the brush cover and fix the clasp.

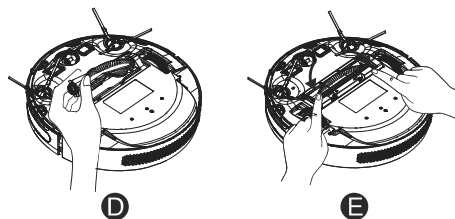
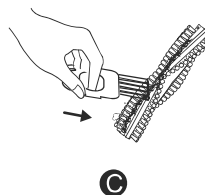
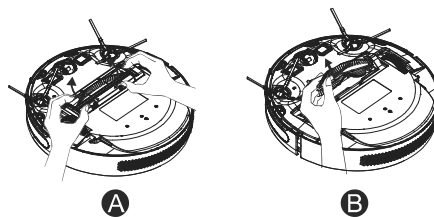

4.3 CLEAN THE SIDE BRUSH

Foreign objects including hair are easy to entangle in the side brush, and dirt may affix to it. Be sure to clean it regularly.

A Remove screws with a Phillips screwdriver.

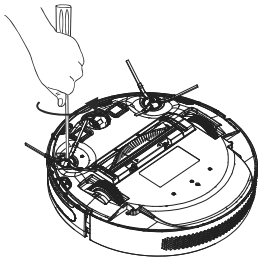

B Carefully rotate and pull out the hair or thread entangled between the vacuum and side brush.

C Use a cloth dampened with warm water to remove dust on the brush or straighten it gently.

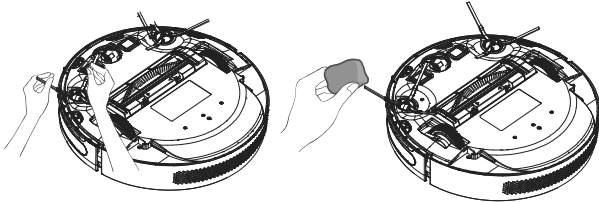

i NOTE

Ensure side brush is completely dry before use.

4.4 REPLACE THE SIDE BRUSH

After a period of use, the side brush may be bent or damaged. Follow the instructions below to replace it.

- A) Use a Phillips screwdriver to unscrew the screws on the side brush.
- B) Remove the old side brush and put in the new side brush.
- C) Tighten the screws to attach the side brush.

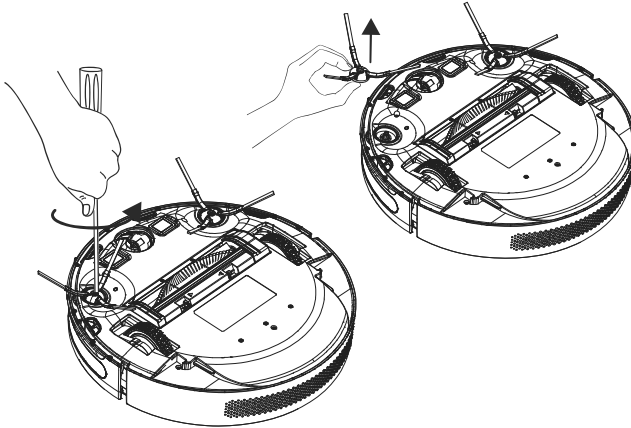

4.5 CLEAN THE UNIVERSAL WHEEL

Hair and dust particles tend to affix to the universal wheel. The universal wheel must be cleaned regularly, or as needed.

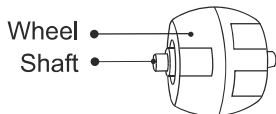

- A) Remove universal wheel by pulling upwards.

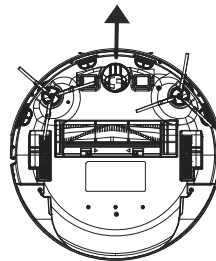

B) Clean away the hair or debris entangled around the wheel or in the wheel cavity.

C) Reinstall the wheel and push it in until it clicks into place.

i NOTE

Do not rinse the universal wheel with water.





5 TROUBLESHOOTING

When the vacuum is running abnormally, the orange light flashes and a voice prompt is broadcast. Please refer to the table below for errors and solutions.

Error name	Error performance and solution
Left wheel error	The left wheel does not rotate, as the wheel is overloaded. Check whether the left wheel gets entangled.
Right wheel error	The right wheel does not rotate because the wheel is overloaded. Check whether the right wheel gets entangled.
Off-the-floor error	The wheels are off the floor. Place vacuum on a level surface and restart.
Seizure error	The vacuum is stuck and cannot move forward. Clear the obstacles around the vacuum and restart it.
Floor inspection error	Check whether the cliff sensor is dirty or blocked. Wipe the cliff sensor and move the vacuum to another position to start.
Low battery error	The battery charge level is low. Please put the vacuum back into the charging dock for re-charge.
Front collision error	Check whether the left, right and front shell collision switches work. Check whether the front bumper is stuck.
Middle sweeping error	The middle sweeping wheel is overloaded or does not rotate. Check whether the main brush gets entangled, and clean the middle sweeping brush.
Side sweeping error	The side sweeping wheel is overloaded or does not rotate. Check whether the side brush gets entangled, and clean the side brush.

Wall inspection error	Check whether the wall sensor is dirty or blocked. Wipe the wall sensor and move it to another position to start.
Fan error	The fan does not rotate, and the current is overloaded. Check whether there are foreign objects in the fan, and if so, remove them.
Dustbin error	The dustbin is not detected. Check whether the dustbin is installed properly.
Charging error	The charging area is polluted. Clean the charging pole pieces. Charging with liquid is prohibited.
Virtual wall error	A virtual wall is detected. Move the vacuum to another position to start.
System error	Reset the sweeper.

6 TECHNICAL PARAMETERS

Functional parameters of the vacuum		Functional parameters of accessories	
Operating voltage	14.4 V 	Power adapter	
Rated power	About 25 W	Input voltage	100-240 V AC
Battery	Lithium battery	Input current	0.5A MAX
Battery capacity	Nominal 2600mAh	Output voltage	19 V 
Charging time	4-5 hoursmAh	Output current	0.6 A 
Operating time	Approx. 90min (standard level)	Charging dock	
Working temperature range	0°-45°	Output voltage	19 V 
Operating humidity range	≤90%RH	Output current	0.6 A 
Noise	≤68dB (standard level)		
Service life	1000h (continuous work)		
Dimensions	Φ355*83mm		
Maximum suction	2200Pa		

Manufacturer reserves the right to make any technical or design changes to the product due to continuous product improvement needs.

7 ENVIRONMENTAL STATEMENT (OPTIONAL)

Component Name	Harmful Substances					
	Lead (Pb)	Mercury (Hg)	Cadmium (Cd)	Hexavalent chromium (Cr (VI))	Polybrominated biphenyl (PBB)	Polybrominated diphenyl ethers (PBDE)
Shell component	<input type="radio"/>	<input type="radio"/>	<input type="radio"/>	<input type="radio"/>	<input type="radio"/>	<input type="radio"/>
Internal plastic parts	<input type="radio"/>	<input type="radio"/>	<input type="radio"/>	<input type="radio"/>	<input type="radio"/>	<input type="radio"/>
Metal parts	X	<input type="radio"/>	<input type="radio"/>	<input type="radio"/>	<input type="radio"/>	<input type="radio"/>
Electrical components and control components	X	<input type="radio"/>	X	<input type="radio"/>	<input type="radio"/>	<input type="radio"/>
Dry batteries	X	<input type="radio"/>	<input type="radio"/>	<input type="radio"/>	<input type="radio"/>	<input type="radio"/>
Rechargeable batteries	X	<input type="radio"/>	<input type="radio"/>	<input type="radio"/>	<input type="radio"/>	<input type="radio"/>

This form is prepared in accordance with the provisions of SJ/T 11364.

○: Indicates that the contents of the hazardous substance in all homogeneous materials of this part are below the required limit specified in GB/T 26572.

X: Indicates that the content of the hazardous substance in at least one of the homogeneous materials of this part exceeds the required limit specified in GB/T 26572.

All parts marked with “X” are in conformity to the EU RoHS Directive, or cannot be replaced by hazardous substances due to global technological development limits.

This form indicates that these hazardous substances exist in our company’s products, but not all of the products included in the package contain all of the above parts.



The service life of batteries used with the product is three (3) years.



The service life of the rechargeable battery used with the product is five (5) years.

8 WARRANTY CARD

WARRANTY CARD II

Name		(II) Settlement form of the warranty provider
Address		
Address		
City/State/Zip		
Product Model		
Purchase Date		
Invoice Number		
Warranty Period		
<p>Product warranty description:</p> <ol style="list-style-type: none"> From the date of the user’s purchase of this product, the warranty period is one year for the vacuum,, and six months for the adapter, rechargeable batteries a nd other accessories. After receiving the product repair request, the a- fter sales service staff will resolve the problem within 15 working days. The user can learn about relevant technical problems by reading the user manual and/or the after sales service hotline to get a clear solution. Hotline: 1-888-909-6757 When a performance failure occurs during the user’s normal use, manufacturer promises to provide the above warranty services unless otherwise stipulated by the applicable laws, rules and regulations of the state. During the warranty period, paid maintenance services will be provided under any of the following circumstances: <ul style="list-style-type: none"> • Damage caused by manmade factors or irresistible natural phenomena; • Failure or damage caused by improper operation by the user; • Malfunction or damage due to the user’s disassembly or alteration without authorization. 		

WARRANTY CARD I

Name		(I) To be kept by the user as warranty certificate, which will not be reissued if lost
Address		
Address		
City/State/Zip		
Product Model		
Purchase Date		
Invoice Number		
Warranty Period		
Date	Repair Technician	Maintenance Record
1.		
2.		
3.		
4.		
5.		