

greenworks **pro**

EN	CHAINSAW	OPERATOR MANUAL
FR	TRONÇONNEUSE	MANUEL D'OPÉRATEUR
ES	SIERRA DE CADENA	MANUAL DEL OPERADOR

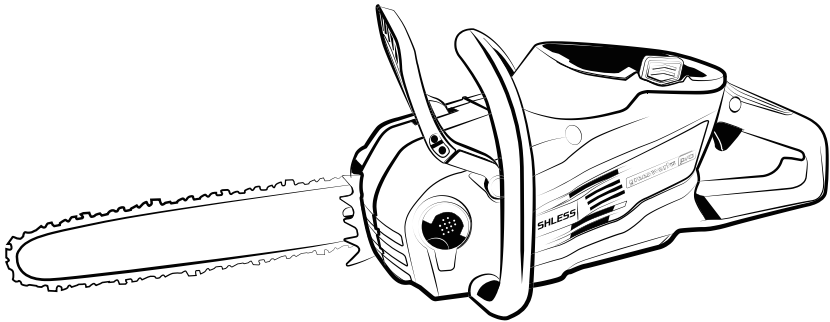

CSB403

www.greenworkstools.com

1	Description.....	2	9.3	Install the battery pack.....	6
1.1	Purpose.....	2	9.4	Remove the battery pack.....	6
1.2	Overview.....	2	10	Operation.....	6
2	General power tool safety warnings.....	2	10.1	Examine the chain oil.....	6
2.1	Work area safety.....	2	10.2	Hold the machine.....	6
2.2	Electrical safety.....	2	10.3	Start the machine.....	7
2.3	Personal safety.....	2	10.4	Stop the machine.....	7
2.4	Power tool use and care.....	2	10.5	Operate the chain brake.....	7
2.5	Battery tool use and care.....	3	10.6	Fell a tree.....	7
2.6	Service.....	3	10.7	Limb a tree.....	8
3	Chainsaw safety warnings.....	3	10.8	Buck a log.....	8
4	Prevent operator kickback.....	4	11	Maintenance.....	9
5	Symbols on the product.....	4	11.1	Replace the guide bar and the chain.....	9
6	Risk levels.....	4	11.2	Adjust the chain tension.....	10
7	Environmentally safe battery disposal.....	5	11.3	Sharpen the cutters.....	10
8	Proposition 65.....	5	11.4	Guide bar maintenance.....	11
9	Installation.....	5	12	Transportation and storage.....	11
9.1	Unpack the machine.....	5	13	Troubleshooting.....	11
9.2	Add the bar and chain oil.....	6	14	Technical data.....	13
			15	Limited warranty.....	13
			16	Exploded view.....	14

1 DESCRIPTION

1.1 PURPOSE

This chainsaw is designed for cutting branches, trunks, logs and beams of a diameter determined by the cutting length of the guide bar. It is only designed to cut wood.

It is only to be used in an outdoor, domestic application by adults.

Do not use the chainsaw for any purpose not listed above.

This chainsaw is not to be used for professional tree services. It is not to be used by children or by persons not wearing adequate personal protective equipment and clothing.

1.2 OVERVIEW

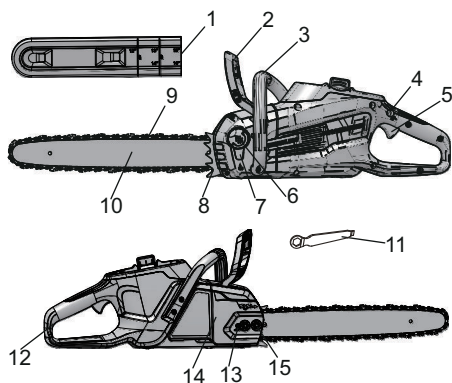

- | | | | |
|---|----------------------------------|----|---------------------|
| 1 | Guide bar cover | 9 | Saw chain |
| 2 | Front handle guard / chain brake | 10 | Guide bar |
| 3 | Front handle | 11 | Wrench |
| 4 | Lock out button | 12 | Rear handle |
| 5 | Trigger | 13 | Chain tension screw |
| 6 | Oil tank cap | 14 | Chain cover |
| 7 | Oil indicator | 15 | Chain cover nuts |
| 8 | Spike bumpers | | |

2 GENERAL POWER TOOL SAFETY WARNINGS

▲ WARNING

Read all safety warnings and all instructions. Failure to follow the warnings and instructions may result in electric shock, fire and/or serious injury.

Save all warnings and instructions for future reference.

The term "power tool" in the warnings refers to your battery-operated (cordless) power tool.

2.1 WORK AREA SAFETY

- **Keep work area clean and well lit.** Cluttered or dark areas invite accidents.
- **Do not operate power tools in explosive atmospheres, such as in the presence of flammable liquids, gases or dust.** Power tools create sparks which may ignite the dust or fumes.
- **Keep children and bystanders away while operating a power tool.** Distractions can cause you to lose control.

2.2 ELECTRICAL SAFETY

- **Do not expose power tools to rain or wet conditions.** Water entering a power tool will increase the risk of electric shock.

2.3 PERSONAL SAFETY

- **Stay alert, watch what you are doing and use common sense when operating a power tool. Do not use a power tool while you are tired or under the influence of drugs, alcohol or medication.** A lapse of attention while operating power tools may result in serious personal injury.
- **Use personal protection. Always wear eye protection.** Protective products such as dust mask, non-skid safety shoes, hard hat or hearing protection used appropriately will reduce personal injuries.
- **Prevent unintentional starting. Ensure the switch is in the off position before connecting to power source and/or battery pack and when picking up or carrying the tool.** Carrying power tools with your finger on the switch or energizing power tools that have the switch on invites accidents.
- **Remove any adjusting key or wrench before turning the power tool on.** A wrench or a key left attached to a rotating part of the power tool may result in personal injury.
- **Do not over-reach. Keep proper footing and balance at all times.** This enables better control of the power tool in unexpected situations.
- **Dress properly. Do not wear loose clothing or jewellery. Keep your hair, clothing and gloves away from moving parts.** Loose clothes, jewellery or long hair can be caught in moving parts.
- **If devices are provided for the connection of dust extraction and collection facilities, ensure these are connected and properly used.** Use of dust collection can reduce dust related hazards.
- **Do not let familiarity gained from frequent use of tools allow you to become complacent and ignore tool safety principles.** A careless action can cause severe injury within a fraction of a second.

2.4 POWER TOOL USE AND CARE

- **Do not force the power tool. Use the correct power tool for your application.** The correct power tool will do

the job better and safer at the rate for which it was designed.

- **Do not use the power tool if the switch does not turn it on and off.** Any power tool that cannot be controlled with the switch is dangerous and must be repaired.
- **Disconnect the plug from the power source and/or the battery pack from the power tool before making any adjustments, changing accessories, or storing power tools.** Such preventive safety measures reduce the risk of starting the power tool accidentally.
- **Store idle power tools out of the reach of children and do not allow persons unfamiliar with the power tool or these instructions to operate the power tool.** Power tools are dangerous in the hands of untrained users.
- **Maintain power tools.** Check for misalignment or binding of moving parts, breakage of parts and any other condition that may affect the power tool's operation. If damaged, have the power tool repaired before use. Many accidents are caused by poorly maintained power tools.
- **Keep cutting tools sharp and clean.** Properly maintained cutting tools with sharp cutting edges are less likely to bind and are easier to control.
- **Use the power tool, accessories and tool bits etc. in accordance with these instructions, taking into account the working conditions and the work to be performed.** Use of the power tool for operations different from those intended could result in a hazardous situation.

2.5 BATTERY TOOL USE AND CARE

- **Recharge only with the charger specified by the manufacturer.** A charger that is suitable for one type of battery pack may create a risk of fire when used with another battery pack.
- **Use power tools only with specifically designated battery packs.** Use of any other battery packs may create a risk of injury and fire.
- **When battery pack is not in use, keep it away from other metal objects like paper clips, coins, keys, nails, screws, or other small metal objects that can make a connection from one terminal to another.** Shorting the battery terminals together may cause burns or fire.
- **Under abusive conditions, liquid may be ejected from the battery; avoid contact.** If contact accidentally occurs, flush with plenty of soap and water. If liquid contacts eyes, immediately seek medical help. Liquid ejected from the battery may cause irritation or burns.

2.6 SERVICE

- **Have your power tool serviced by a qualified repair person using only identical replacement parts.** This will ensure that the safety of the power tool is maintained.

3 CHAINSAW SAFETY WARNINGS

- **Keep all parts of the body away from the saw chain when the chainsaw is operating.** Before you start the chainsaw, make sure the saw chain is not in contact with anything. A moment of inattention while operating chainsaws may cause entanglement of your clothing or body with the saw chain.
- **Always hold the chainsaw with your right hand at the rear handle and your left hand at the front handle.** Holding the chainsaw with a reversed hand configuration increases the risk of personal injury and should never be done.
- **Hold the power tool by insulated gripping surfaces only,** because the saw chain may contact hidden wiring. Saw chains contacting a "live" wire may make exposed metal parts of the power tool "live" and could give the operator an electric shock.
- **Wear safety glasses and hearing protection. Further protective product for head, hands, legs and feet is recommended.** Adequate protective clothing will reduce personal injury from flying debris or accidental contact with the saw chain.
- **Do not operate a chainsaw in a tree.** Operation of a chainsaw while up in a tree may result in personal injury.
- **Always keep proper footing and operate the chainsaw only when standing on fixed, secure and level surface.** Slippery or unstable surfaces such as ladders may cause loss of balance or control of the chainsaw.
- **When cutting a limb that is under tension, be alert of spring back.** When the tension in the wood is released, the spring loaded limb may strike the operator and/or throw the chainsaw out of control.
- **Use extreme caution when cutting brush and saplings.** The slender material may catch the saw chain and be whipped toward you or pull you off balance.
- **Carry the chainsaw by the front handle with the chainsaw switched off and away from your body.** When transporting or storing the chainsaw, always fit the guide bar cover. Proper handling of the chainsaw will reduce the likelihood of accidental contact with the moving saw chain.
- **Follow instructions for lubricating, chain tensioning and changing accessories.** Improperly tensioned or lubricated chain may either break or increase the chance for kickback.
- **Keep handles dry, clean, and free from oil and grease.** Greasy, oily handles are slippery, causing loss of control.
- **Cut wood only. Do not use chainsaw for purposes not intended.** For example: do not use chainsaw for cutting plastic, masonry or non-wood building materials. Use of the chainsaw for operations other than intended could result in a hazardous situation.

4 PREVENT OPERATOR KICKBACK

Kickback may occur when the nose or tip of the guide bar touches an object, or when the wood closes in and pinches the saw chain in the cut.

Tip contact in some cases may cause a sudden reverse reaction, kicking the guide bar up and back towards the operator.

Pinching the saw chain along the top of the guide bar may push the guide bar rapidly back towards the operator.

Either of these reactions may cause you to lose control of the saw which could result in serious personal injury. Do not rely exclusively upon the safety devices built into your saw. As a chainsaw user, you should take several steps to keep your cutting jobs free from accident or injury.

Kickback is the result of tool misuse and/or incorrect operating procedures or conditions and can be avoided by taking proper precautions as given below:



- **Maintain a firm grip, with thumbs and fingers encircling the chainsaw handles, with both hands on the saw and your body and arm positioned to allow you to resist kickback forces.**







Kickback forces can be controlled by the operator, if proper precautions are taken. Do not let go of the chainsaw.

- **Do not overreach and do not cut above shoulder height.** This helps prevent unintended tip contact and enables better control of the chainsaw in unexpected situations.
- **Only use replacement bars and chains specified by the manufacturer.** Incorrect replacement bars and chains may cause chain breakage and/or kickback.
- **Follow the manufacturer's sharpening and maintenance instructions for the saw chain.** Decreasing the depth gauge height can lead to increased kickback.

5 SYMBOLS ON THE PRODUCT



Some of the following symbols may be used on this product. Please study them and learn their meaning. Proper interpretation of these symbols will allow you to operate the product better and safer.

Symbol	Explanation
	Direct current-Type or characteristic of current.
	Precautions that involve your safety.
	Read and understand all instructions before operating the product, and follow all warnings and safety instructions.

Symbol	Explanation
	Wear eye and ear protection.
	Do not expose the product to rain or moist conditions.
	Avoid bar nose contact.
	Hold with both hands.
	DANGER! Be careful with kickbacks.
	Wear non-slip, heavy duty gloves.
	Keep all bystanders at least 15m (50 feet) away.

6 RISK LEVELS

The following signal words and meanings are intended to explain the levels of risk associated with this product.

SYM-BOL	SIGNAL	MEANING
	DANGER	Indicates an imminently hazardous situation, which, if not avoided, will result in death or serious injury.
	WARNING	Indicates a potentially hazardous situation, which, if not avoided, could result in death or serious injury.
	CAUTION	Indicates a potentially hazardous situation, which, if not avoided, may result in minor or moderate injury.
	CAUTION	(Without Safety Alert Symbol) Indicates a situation that may result in property damage.

7 ENVIRONMENTALLY SAFE BATTERY DISPOSAL



The toxic and corrosive materials below are in the batteries used in this machine: **Lithium-Ion, a toxic material.**

▲ WARNING

Discard all toxic materials in a specified manner to prevent contamination of the environment. Before discarding damaged or worn out Li-ion battery, contact your local waste disposal agency, or the local Environmental Protection Agency for information and specific instructions. Take the batteries to a local recycling and/or disposal center, certified for lithium-ion disposal.

▲ WARNING

If the battery pack cracks or breaks, with or without leaks, do not recharge it and do not use. Discard it and replace with a new battery pack. **DO NOT TRY TO REPAIR IT!** To prevent injury and risk of fire, explosion, or electric shock, and to avoid damage to the environment:

- Cover the terminals of the battery with heavy-duty adhesive tape.
- **DO NOT** try to remove or destroy any of the battery pack components.
- **DO NOT** try to open the battery pack.
- If a leak develops, the released electrolytes are corrosive and toxic. **DO NOT** get the solution in the eyes or on skin, and do not swallow it.
- **DO NOT** put these batteries in your regular household trash.
- **DO NOT** incinerate.
- **DO NOT** put them where they will become part of any waste landfill or municipal solid waste stream.
- Take them to a certified recycling or disposal center.

8 PROPOSITION 65

▲ WARNING

This product contains a chemical known to the state of California to cause cancer, birth defects or other reproductive harm. Some dust created by power sanding, sawing, grinding, drilling, and other construction activities contains chemicals known to cause cancer, birth defects or other reproductive harm. Some examples of these chemicals are:

- Lead from lead-based paints;
- Crystalline silica from bricks and cement and other masonry products;
- Arsenic and chromium from chemically treated lumber.

Your risk of exposure to these chemicals varies depending on how often you do this type of work. To reduce your exposure to these chemicals, work in a well-ventilated area, and work with approved safety equipment, such as dust masks that are specially designed to filter out microscopic particles.

Save these instructions.

9 INSTALLATION

▲ WARNING

Do not change or make accessories that are not recommended by the manufacturer.

▲ WARNING

Do not install battery pack until you assemble all the parts.

9.1 UNPACK THE MACHINE

▲ WARNING

Make sure that you correctly assemble the machine before use.

▲ WARNING

- If the parts are damaged, do not use the machine.
- If you do not have all the parts, do not operate the machine.
- If the parts are damaged or missing, speak to the service center.

1. Open the package.
2. Read the documentation in the box.
3. Remove all the unassembled parts from the box.
4. Remove the machine from the box.
5. Discard the box and package in compliance with local regulations.

9.2 ADD THE BAR AND CHAIN OIL

Examine the amount of oil in the machine. If the oil level is low, add the bar and chain oil as follows.

i IMPORTANT

Use bar and chain oil that is only for chains and chain oilers.

i NOTE

The machine comes from the factory without bar and chain oil.

1. Loosen and remove the cap (6) from the oil tank.

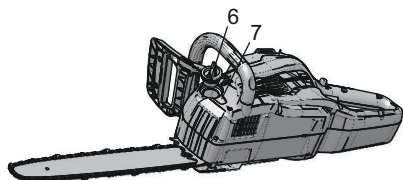

2. Put the oil into the oil tank.
3. Monitor the oil indicator (7) to make sure that no dirt gets into the oil tank while you add the oil.
4. Put the oil cap on.
5. Tighten the oil cap.
6. The whole oil tank will last for approximately 20- 40 minutes.

i IMPORTANT

Do not use dirty, used or contaminated oil. Damage can occur to the bar or chain.

9.3 INSTALL THE BATTERY PACK

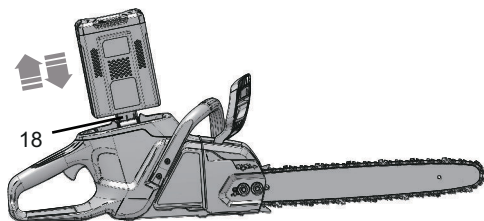

▲ WARNING

- If the battery pack or charger is damaged, replace the battery pack or the charger.
- Stop the machine and wait until the motor stops before you install or remove the battery pack.
- Read and understand the instructions in the battery and charger manual.

1. Align the lift ribs on the battery pack with the grooves in the battery compartment.
2. Push the battery pack into the battery compartment until the battery pack locks into place.
3. When you hear a click, the battery pack is installed.

9.4 REMOVE THE BATTERY PACK

1. Push and hold the battery release button (18).
2. Remove the battery pack from the machine.

10 OPERATION

i NOTE

Remove the battery pack and keep hands clear of the lock out button when you move the machine.

i IMPORTANT

Examine the chain tension before each use.

10.1 EXAMINE THE CHAIN OIL

i NOTE

Do not use the machine without sufficient chain oil.

1. Examine the oil level of the machine from the oil indicator.
2. Add the oil if it is necessary.

10.2 HOLD THE MACHINE

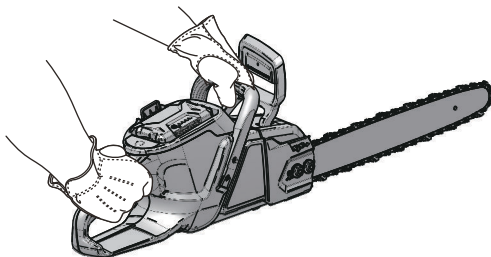

1. Hold the chainsaw with your right hand on the rear handle and left hand on the front handle.
2. Hold the handles with the thumbs and the fingers around them.
3. Make sure that your left hand holds the front handle and your thumb is below the handle.

10.3 START THE MACHINE

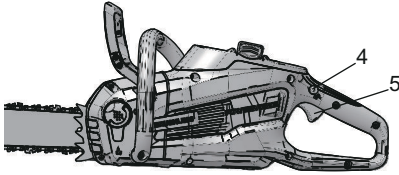

1. Press the lock-out button (4).
2. Press the trigger (5) while you hold the lock-out button.
3. Release the lock-out button.

i IMPORTANT

The chain brake must be disengaged for the chain saw to start. Activate the brake by moving the front hand guard forwards.

10.4 STOP THE MACHINE

1. Release the trigger to stop the machine.

10.5 OPERATE THE CHAIN BRAKE

▲ WARNING

Make sure that your hands are on the handles at all times.

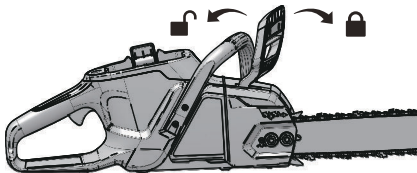

1. Start the machine.
2. Push the guard forward to engage the chain brake.
3. Pull the handle guard / chain brake backwards to disengage the chain brake.
4. Call approved service center for repair before use if
 - The chain brake does not stop the chain immediately.
 - The chain brake does not stay in the disengaged position without aid.

10.6 FELL A TREE

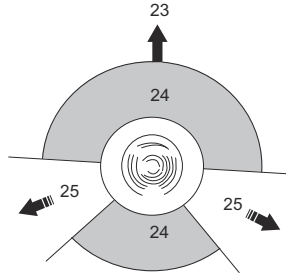

Recommendation that the first-time user should, as a minimum practice, start cutting logs on a saw-horse or cradle.

Before you start to fell a tree, make sure that

- The minimum distance between the areas of bucking and felling is two times the height of the tree.
- The operation does not
 - Cause injury to personnel.
 - Hit utility lines. If the tree touches utility lines, immediately tell the utility company.
 - Cause losses in property.
- The user is not in the danger area (24), for example, the downhill side of the area.
- The escape paths (25) that extend back and diagonally behind the felling direction (23) are clear. The felling direction is controlled by
 - The natural lean of the tree.
 - The location of larger branches.
 - The wind direction.
- Ensure there is no dirt, stones, loose bark, nails, and staples on the tree.

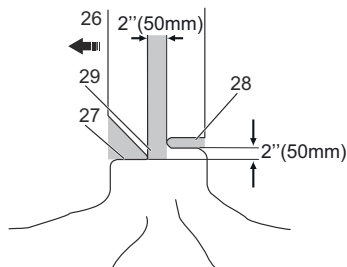

1. **Make a lower level notching cut (27). Make sure that this cut is**
 - a) 1/3 wide of the diameter of the tree.
 - b) Perpendicular to the felling direction.

▲ CAUTION

The level notching cut helps prevent pinching of the saw chain or the guide bar when you make the second notch.

2. **Make the felling cut no less than 2 in. (50 mm) and higher than the level notching cut. Make sure that this cut**

- Is parallel to the level notching cut.
- Keeps sufficient wood to become a hinge (29) which prevents the tree from twisting and felling in the wrong direction.

When the felling cut (28) gets near the hinge (29), the tree falls. Stop the felling cut if the tree

- Does not fall in the correct direction or
- Moves backwards, causing the cutting bar and chain to become stuck in the cut.

3. **Use felling wedge to open the cut and let the tree fall in the correct direction.**

4. **When the tree starts to fall,**

- Remove the chainsaw from the cut.
- Stop the machine.
- Put the machine down.
- Move away from the tree via the escape path (25). Always keep watching the tree to see its direction of fall, be careful with overhead branches and your footing.

10.7 LIMB A TREE

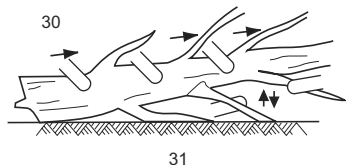

Limbing is the removal of the branches from a fallen tree.

- Keep the larger lower branches to hold the log off the ground (31).
- Remove the small limbs (30) in one cut.
- Limb the branches with tension from the bottom to top.
- Keep the larger lower branches as a support until the log is limbed.

10.8 BUCK A LOG

To buck is to cut a log into lengths.

▲ CAUTION

Do not let the chain saw touch the ground.

It is important to make sure your footing is secure and your weight is evenly distributed. If possible, lift the log and hold it with branches, logs or chock. Obey the instructions below:

33

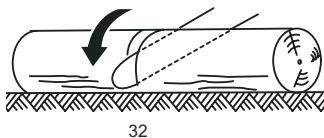

When the log is held along the full length (32), cut it from the top (33).

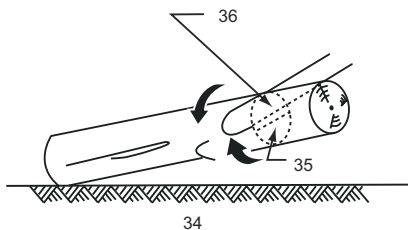

When the log is held on one end (34),

- Cut the first time 1/3 of the diameter from the bottom (35).
- Cut the second time from the top (36) to complete the bucking.

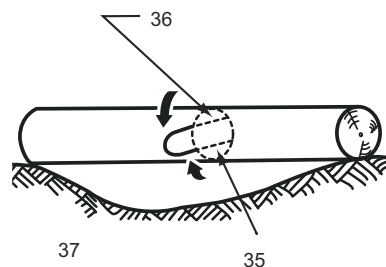

When the log is held on two ends (37),

- Cut the first time 1/3 of the diameter from the top (36).
- Cut the second time lower 2/3 from the bottom to complete the bucking (35).

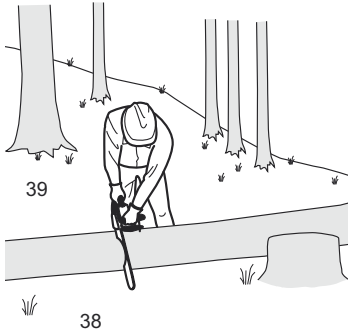

When the log is on a slope,

1. Stand on the uphill side.
2. Control the chain saw completely.
3. Hold the chain saw handles tightly.
4. Release the cutting pressure near the end of the cut.

When bucking is complete (38),

1. Wait for the chain to stop (39).
2. Ensure the chainsaw is turned off.
3. Check for hazards before you move to another tree.

11 MAINTENANCE

▲ CAUTION

Do not let brake fluids, gasoline, petroleum-based materials touch the plastic parts. Chemicals can cause damage to the plastic, and make the plastic unserviceable.

▲ CAUTION

Do not use strong solvents or detergents on the plastic housing or components.

▲ WARNING

Remove the battery pack from the machine before maintenance.

11.1 REPLACE THE GUIDE BAR AND THE CHAIN

1. Remove the chain cover nuts with the wrench.
2. Remove the chain cover.

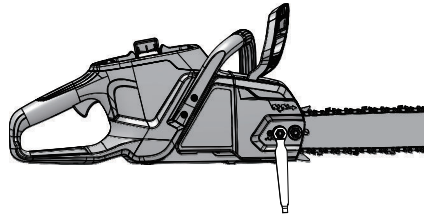

3. Put the chain drive links (21) into the bar groove (20).
4. Put the chain cutters (22) in the direction of the chain operation.

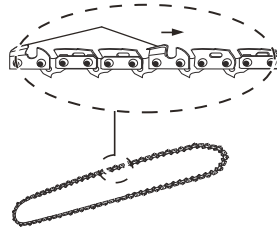

5. Put the chain in position and make sure that the loop is behind the guide bar.
6. Hold the chain and bar.

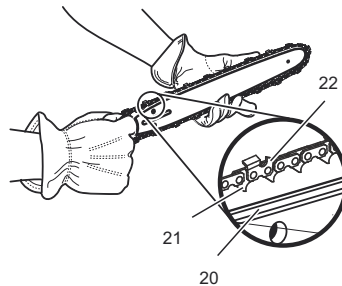

7. Put the chain loop around the sprocket (17).
8. Make sure the chain tension pin hole (19) on the guide bar fits correctly with the bolt (16).

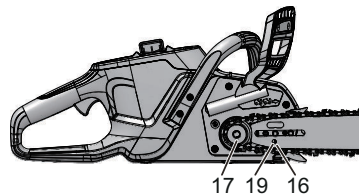

9. Install the chain cover.
10. Tighten the chain. Refer to *Adjust the chain tension*.
11. Tighten the nuts when the chain is correctly tensioned.

i NOTE

If you start the chain saw with a new chain, have a test for 2-3 minutes. A new chain gets longer after the first use, examine the tension and tighten the chain if necessary.

11.2 ADJUST THE CHAIN TENSION

The more you use a chain the longer it becomes. It is therefore important to adjust the chain regularly to take up the slack.

Tension the chain so that it can only just be pulled away from the bar at its centre point.

▲ WARNING

A slack chain may jump off and cause serious or even fatal injury.

▲ CAUTION

Wear protective gloves if you touch the chain, bar or areas around the chain.

1. Stop the machine.
2. Loosen the lock nuts with the wrench.

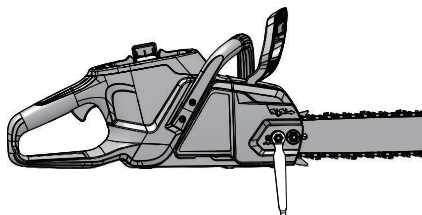

i NOTE

It is not necessary to remove the chain cover to adjust the chain tension.

3. Turn the chain adjustment screw clockwise to increase the chain tension.
4. Turn the chain adjustment screw counterclockwise to decrease the chain tension.

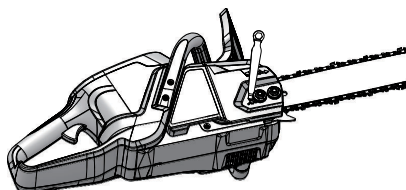

5. When the chain is at the wanted tension, tighten the lock nuts.

11.3 SHARPEN THE CUTTERS

Sharpen the cutters if it is not easy for the chain to go into the wood.

i NOTE

We recommend that a service center, which has an electric sharpener, perform important sharpening work.

1. Tensioning chain.

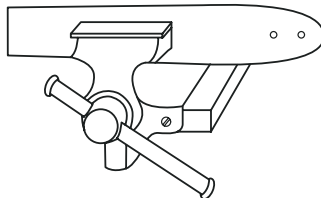

2. Sharpen the cutters corner with a 5/32 in. (4 mm) diameter round file .

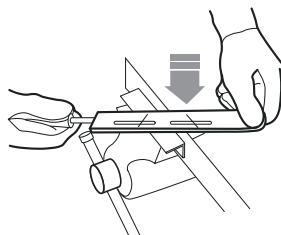

3. Sharpen the top plate, side plate and depth gauge with a flat file.

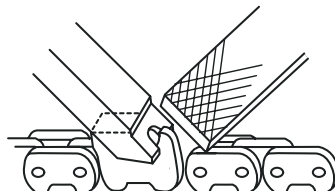
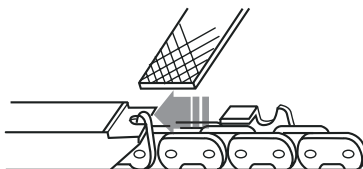

4. File all the cutters to the specified angles and the same length.

i NOTE

During the process,

- Keep the file flat with the surface to be sharpened.
- Use the midpoint of the file bar.
- Use light but firm pressure when sharpening the surface.
- Lift the file away on each return stroke.
- Sharpen the cutters on one side and then move to the other side.

Replace the chain if:

- The length of the cutting edges is less than 1/5 in. (5 mm).
- There is too much space between the drive links and the rivets.
- The cut speed is slow
- Sharpening the chain many times but it does not increase the cutting speed. The chain is worn.

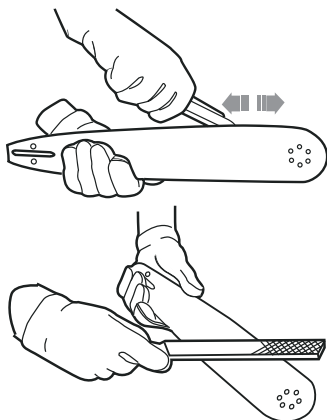
11.4 GUIDE BAR MAINTENANCE**i NOTE**

Make sure that it is turned over periodically to keep symmetrical wear on the bar.

1. Lubricate the bearings on the nose sprocket (if present) with the syringe (not included).
2. Clean the bar groove with the scraping hook (not included).
3. Clean the lubrication holes.
4. Remove burr from the edges and level the cutters with a flat file.

Replace the bar if:

- the groove does not fit with the height of the drive links (which must never touch the bottom).
- the inside of the guide bar is worn and makes the chain lean to one side.

12 TRANSPORTATION AND STORAGE

Before you move the machine, always

- Remove the battery pack from the machine.
- Keep hands clear of the lock-out button.
- Put the scabbard on the guide bar and the chain.

Before you put the machine into storage, always

- Remove all residual oil from the machine.
- Remove the battery pack from the machine.
- Clean all unwanted material from the machine.
- Make sure that the storage area is
 - Not available to children.
 - Away from agents which can cause corrosion, such as garden chemicals and de-icing salts.

13 TROUBLESHOOTING

Problem	Possible cause	Solution
The guide bar and the chain become hot and release smoke.	The chain is too tight.	Adjust the chain tension.
	The oil tank is empty.	Add lubricants.
	Contamination causes a blockage of the discharge port.	Remove the guide bar and clean the discharge port.
	Contamination causes a blockage of the oil tank.	Clean the oil tank. Add new lubricant.
	Contamination causes a blockage of the guide bar and the oil tank cap.	Clean the guide bar and the oil tank cap.
	Contamination causes a blockage of the sprocket or guide wheels.	Clean the sprocket and the guide wheels.

Problem	Possible cause	Solution
The motor runs but the chain does not rotate.	The chain is too tight.	Adjust the chain tension.
	The guide bar and the chain are damaged.	Replace the guide bar and the chain if it is necessary.
	The motor is damaged.	<ol style="list-style-type: none"> 1. Remove the battery pack from the machine. 2. Remove the guide bar cover. 3. Remove the bar and saw chain. 4. Clean the machine. 5. Install battery pack and operate the machine.
The motor runs and the chain rotates, but the chain does not cut.		The chain is blunt.
	The chain is in the incorrect direction.	Turn the chain loop to the other direction.
	The chain is tight or loose.	Adjust the chain tension.

Problem	Possible cause	Solution
The machine does not start.	The chain brake is engaged.	Pull the chain brake in the direction of the user to disengage it.
	The machine and battery are not connected correctly.	Make sure that the battery release button clicks when you install the battery pack.
	The battery level is low.	Charge the battery pack.
	The lock out button and the trigger are not pushed at the same time.	<ol style="list-style-type: none"> 1. Push the lock-out button and hold it. 2. Push the trigger to start the machine.
	The battery is too hot or too cold.	Refer to battery and charger manual.
The machine does not start when the battery pack only has one or two lights flash.	1. The battery pack is in a low capacity.	<ol style="list-style-type: none"> 1. Cool the battery pack or machine to ambient temperature. 2. Charge the battery pack again. 3. Start the machine again.
	2. The battery pack or control board at high temperature protective state.	
The motor runs, but the chain does not cut correctly, or the motor stops after around 3 seconds.	The machine is in the protection mode to protect the PCB.	Release the trigger and start the machine again. Do not force the machine to cut.
	The battery is not charged.	Charge the battery. Refer to the battery and charger manual for correct charging procedures.
	The chain is not lubricated.	Lubricate the chain to decrease the friction. Do not let the guide bar and the chain operate without sufficient lubricant.
	Incorrect battery storage temperature	Cool the battery pack until it decreases to the ambient temperature.

14 TECHNICAL DATA

Voltage	80 V DC
No load speed	10.5 m/s
Guide bar length	18" (458 mm)
Chain pitch	3/8" LP (9.5 mm)
Chain gauge	.050" (1.27 mm)
Drive links	62
Chain oil capacity	200 ml
Weight (without battery pack)	8.7 lbs (3.95 kg)
Chain	91P062X/CL15062
Guide bar	180SDEA041/ M1501862-1041TL
Battery model	BAB726 and other BAB series
Charger model	2901402 and other CAB series

15 LIMITED WARRANTY



Greenworks hereby warrants this product, to the original purchaser with proof of purchase, for a period of four (4) years against defects in materials, parts or workmanship. Greenworks, at its own discretion will repair or replace any and all parts found to be defective, through normal use, free of charge to the customer. This warranty is valid only for units which have been used for personal use that have not been hired or rented for industrial/commercial use, and that have been maintained in accordance with the instructions in the owners' manual supplied with the product from new.

ITEMS NOT COVERED BY WARRANTY:

1. Any part that has become inoperative due to misuse, commercial use, abuse, neglect, accident, improper maintenance, or alteration; or
2. The unit, if it has not been operated and/or maintained in accordance with the owner's manual; or
3. Normal wear, except as noted below;
4. Routine maintenance items such as lubricants, blade sharpening;
5. Normal deterioration of the exterior finish due to use or exposure.

HELPLINE:

Warranty service is available by calling our toll-free helpline, at 1-855-345-3934.

TRANSPORTATION CHARGES:

Transportation charges for the movement of any power equipment unit or attachment are the responsibility of the purchaser. It is the purchaser's responsibility to pay transportation charges for any part submitted for replacement under this warranty unless such return is requested in writing by Greenworks.

USA address:

Greenworks Tools
P.O. Box 1238
Mooresville, NC 28115

Canadian address:

Greenworks Tools Canada Inc.
1110 Stellar Drive Unit 102
Newmarket, ON, L3Y 7B7

16 EXPLODED VIEW

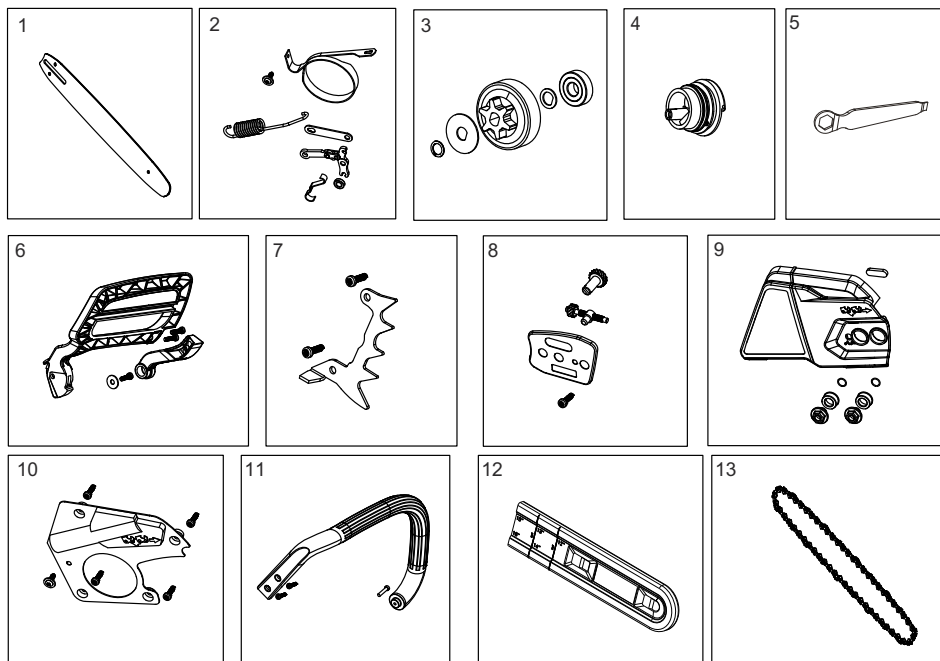

No .	Part No.	Qty	Description	No .	Part No.	Qty	Description
1		1	Bar	8	R0200625-00	1	Tensioner Kit
2	RB339022028A	1	Chain Brake Kit	9	R0200192-00	1	Sprocket Cover Assembly
3	R0200302-00	1	Sprocket Kit	10	R0200626-00	1	Bar Pad Cover
4	R0200624-00	1	Oil Cap Assembly	11	R0200003-00	1	Auxiliary Handle Kit
5		1	Wrench	12		1	Scabbard
6	R0200009-00	1	Chain Brake Handle	13		1	Chain
7	R0200012-00	1	Bucking Spikes				