

Hoftrac®



WEIDEMANN
designed for work



The multifunctional Hoftracs®.
Powerful helper for every application.





Your personal Hoftrac®.

Compact design, low centre of gravity, tight turning radius and powerful performance – these features characterised the Hoftrac® series and still determine the success of our machines.

Our base models offer you the starting basis for a tailored-to-suit outfitting of your machine. With the lower priced entry models, you receive the option to freely configure your machine: Choose from among the numerous options the ones that you need for your application. You can rest assured that your machine corresponds entirely to your individual needs. And the best thing about the Hoftrac® concept: With our series, you only pay for what you really need.

Compact and manoeuvrable Hoftracs®.

Tailored-to-suit fit out and powerful performance.

A feel-good working area.
More on pages 16 -19



Efficient change of attachments.
More on page 11.

Serviceability with with the laterally
tiltable operator's cab.
More on page 15.



Excellent corrosion resistance
thanks to the powder-coating.
More on pages 26 - 27

Flexibly selectable operator's cabs.
More on pages 12 - 13

Road capability with articulated
pendulum joint.
More on page 10.



1140
1140 Basic Line



1160



1160 eHoftrac®



124OLP



1280



1390



1880

Emission standard and engine technology.

With Weidemann, you are well-equipped for the future!

In addition to the integration of an exhaust after-treatment in the form of a particulate filter, the adaptation of the machines to Stage V also requires an additional optimisation of the cooling capacity. This is achieved through a cooled exhaust gas recirculation. A positive side effect is that these new components not only contribute to reducing emissions, but also the performance of the machines can be greatly improved and fuel consumption can be reduced by approximately 5% –convincing arguments!

The applied diesel particulate filter (DPF), which filters out a great deal of harmful soot particles, is automatically regenerated at the corresponding temperature by burning out the deposited particles during operation – without restrictions for man or machine.

In the Weidemann Hoftrac® series there are entry engines for each model that are below 19 kW and therefore manage without an exhaust emission aftertreatment, but comply with the exhaust emission Stage V. They are suitable for the operator who demands less operating hours of their machine. For more power, there are more powerful engines for each model. Here, the exhaust emission Stage V has been realised through the installation of a diesel particulate filter (DPF) together with a diesel oxidation catalyst (DOC). With this technology, there is no need to add any urea solution (DEF)



The Weidemann diagnosis and analysis system.

Hot on the trail for errors with wedias.

The new engine technology involves new systems for maintenance and analysis. The sometimes drawn-out search for hidden failures is a thing of the past. With help from the Weidemann diagnostic and analysis system wedias there are many functions, such as the driving function, the 3rd and 4th the 3rd and 4th control circuits, the engine data and the electrical functions can now be quickly and unambiguously evaluated. Error messages in the display immediately notify the operator of possible failures and make a rapid response possible.

Thanks to the exact designation of the error number, the dealer can come to the machine prepared and with the right spare parts. The subsequent error analysis by trained dealers simplifies further diagnosis and troubleshooting. This saves time, money and nerves.

EquipCare.

Simply be better prepared.

A modern fleet management is a good basis for the successful and economically advantageous application of work machines within your operation. With our telematics solution, Weidemann EquipCare, you have an eye on your machine(s) all the time and know their exact status, availability and use.

A comfortable and site-independent application is guaranteed with the EquipCare Manager (PC, laptop) and the EquipCare app (mobile end device).

Weidemann machines can already be equipped with the EquipCare module ex works so that it isn't necessary to install it later. You receive your access data promptly prior to delivery of your machine. Should you however, wish to equip your existing machine with EquipCare, our distribution partners will be glad to retrofit it for you.

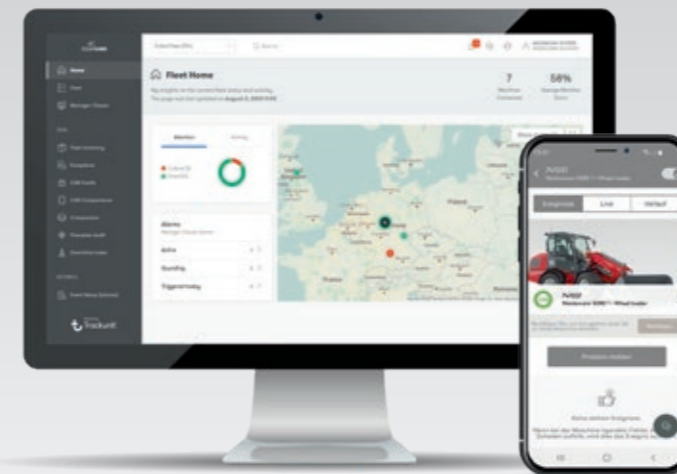

Secure Warranty Extension.

Drive with security.

With Weidemann Secure, our provision for warranty term extensions, you can protect your machine investment again and receive your all-round, carefree package directly from the manufacturer. In doing so, you can select from two attractive packages:

- **Economy Secure:** with the Economy package, you will receive a fair entry price for the comprehensive protection of your machine with a low excess.
- **Premium Secure:** with the Premium Secure, all warranty incidents are easily controllable without an excess.

You can either decide upon a Secure package when buying the machine or conclude a warranty extension flexibly some time after purchase. Subsequent conclusion can be implemented before a max. 500 operating hours or a max. 6 months after machine delivery - depending on which is reached first.



EquipCare provides you with the following benefits:

- Precise information on your machine's operating data (e.g. operating hours, engine load, driving speed, routes, etc.).
- State of the machine (e.g. engine temperatures, cooling and hydraulic, etc.).
- Machine's fill levels (e.g. fuel, hydraulic oil, coolant, etc.).
- Improved service management with concrete planning of notifications for maintenance, disruptions and repairs.
- Generate reduced downtime with remote diagnostics, because the service partner already has a range of information without ever visiting the machine on-site.
- Simple development of warranty claims because the cause of damage can be easily identified.
- Theft protection for the machine through geo-fencing and the complete provision of location in realtime. This provides better conditions with some insurers due to the tracking option.
- Increasing the run-time and service life your machine thanks to the proactive communication.
- Higher resale value of used machines.
- Possible compatibility with apps from other manufactures: With this, you can develop fleet management for your whole fleet.



Weidemann ecDrive.

Electronic controlled drive.



With the new electronic controlled drive ecDrive (Electronic Controlled Drive), the machine can be driven completely needs-based and used. Weidemann has fitted four different drive modes specifically for this purpose. Both of the following drive modes are included as standard:

- **Auto-mode:** ensures the machine's usual 100% performance.
- **Eco-mode:** the engine speed reduces to 2,200 revs/min once the desired driving speed has been reached. This enables a reduction of noise as well as a saving on fuel.

The two other drive modes are designed specifically for use with hydraulically-operated attachments or for the optimised execution of the Y loading cycle. The following two drive modes are optional:

- **Attachment-mode:** this mode perfectly supports the application of attachments. Here, the operator sets the speed of the diesel engine with the throttle and controls

the driving speed with the foot pedal or cruise control. With these controls, speeds can be very finely set in increments of 0.10 km/h, via the display. This ensures a constant feed for the attachment. If the load on the attachment is too great (e.g. various cut material in front of a mulcher), the machine automatically restricts the speed to ensure the best possible performance for the attachment. Once the load is cleared, the machine returns to the preset speed. This is done using a cruise control function. However, if the operator still wishes to drive or reverse at a higher speed, they can override the cruise control at any time via the foot pedal, and can even increase the speed of the machine to its maximum.

- **M-drive mode:** this mode should be used for the optimised execution of Y loading cycles. Here, the operator sets the engine speed with the throttle and controls the driving speed and/or control pressure with the foot pedal. This dispenses with the need for "inching" and supports the execution of fast Y loading cycles.

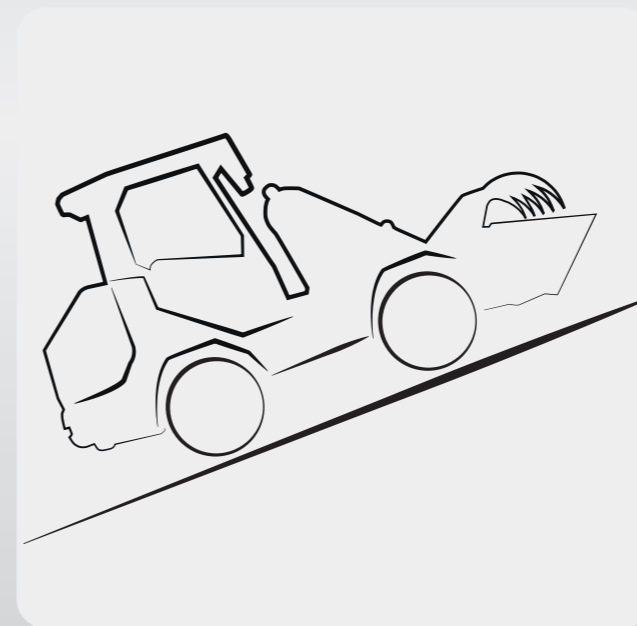

Electric parking brake.

The new electrical parking brake provides another auto-hold function, in addition to the hill-hold function. The brake is applied automatically when the machine comes to a standstill, when the machine is in neutral or when the operator leaves the seat. The parking brake is likewise automatically released when the machine is engaged using the accelerator. Naturally, the brake can also be applied or released manually by pressing the switch.

The basic Weidemann virtues.

Agile, multi-functional, and suitable for all terrains.

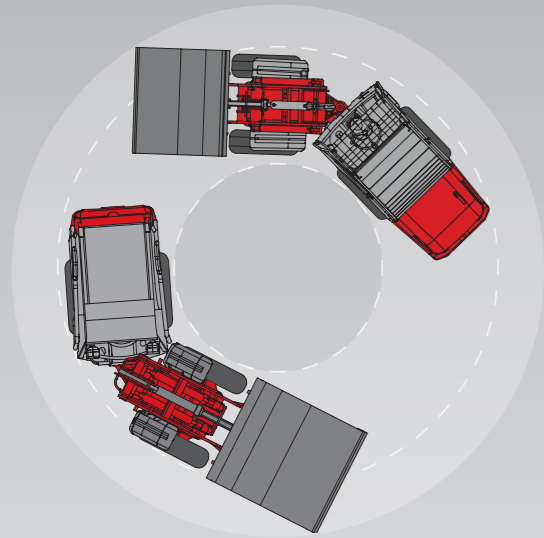

A multi-tool for various applications.

Regardless of whether you are feeding, mucking out, sweeping, stacking or transporting: Thanks to the various attachments, your Weidemann Hoftrac® becomes a universal multi-tool. You can find more about this on pages 28–31.

Compact machines with a high level of manoeuvrability.

Especially when things become tight, e.g. work in stables and storage areas, our Hoftracs® feature small radius and optimum manoeuvrability.

Variety in the outfitting.

The Weidemann Hoftracs® feature comprehensive and sturdy standard equipment. Depending on application and preferences, the engine, shafts, drive, operator's cab or hydraulics can be individually configured. Your Weidemann is always custom-made. A selection of the standard equipment and options available can be found on page 37 and at www.weidemann.de.



Machine with trailer.

Thanks to the ball hitch, the Weidemann Hoftracs® 1390 and 1880 can pull a trailer with a total weight of between 2.5 t and 3.5 t - depending on the model. In Germany, the machine must be approved as a self-propelled work machine with ball hitch or as a tractor. To find out about international regulations, please contact your local Weidemann distributor.



The backbone of the Weidemann design: The legendary articulated pendulum joint.

Weidemann Hoftracs® always run with all four wheels on the ground, in any situation, in any ground conditions. And because the front and rear carriage can oscillate self-contained of each other, they react sensitively to every unevenness. The benefits: You always drive with maximum traction and no power is wasted.



Efficient change of attachments.

Thanks to the hydraulic quick-change system, attachments can be readily exchanged. Your Weidemann machine is therefore always ready for use. This increases productivity and profitability.



Changing attachments with additional function made easy!

Hydraulically-operated attachments can be easily and safely changed from the operator's seat thanks to the Weidemann ecs (Easy Coupler System). The operator need not leave the machine to manually connect the hydraulic couplings. This increases the operator's safety, protects the environment because less oil drips onto the ground and also increases productivity as a result of the clear saving of time.

Choose your operator's compartment.

Smart solutions for all operating conditions.

Secure operator's canopy with restraint system.

Maximum safety that is state of the art. As a standard, Weidemann installs an operator's canopy with a restraint system on all Hoftrac® models. The operator's canopy and the restraint system for the operator meet the current European machinery directive (2006/42/EC) for ROPS and FOPS protection. Depending on the model, a front and rear window are optionally available in order to protect the operator from the weather.



Comfortable cabin.

The spacious cabin meets the current European machine directive (2006/42/EC) for ROPS and FOPS protection and offers a great deal of headroom and freedom of movement. Thanks to the complete glazing, the operator has an excellent overview of the attachments and the entire working area. For which models the cabin is available, see page 37.



1240LP – Low Position.

The lower seating position of the operator allows for a lower overall height of the machine. Other advantages: ground-level machine centre of gravity and a convenient exit.



Foldable operator's canopy (Easy Protection System).

Optionally, all Weidemann Hoftracs® (except for 1240LP and 1880) are outfitted with the fold-down operator's canopy eps. It also meets the current European machine directive (2006/42/EC) for ROPS and FOPS protection. With a few hand movements, the eps can be manually prepared for a low clearance height.

Hydraulically lowerable operator's canopy epsPlus (Easy Protection System Plus).

The optionally available epsPlus is a hydraulically lowerable operator's canopy, which the operator can operate from his seat. It solves the problem of low clearance heights and considerably facilitates work on the job. The epsPlus is a convenient solution with a tremendous time savings and high safety standards – available for 1160, 1160 eHoftrac®.



Awarded with:



Economic efficiency that's worth it.

Efficient work operation thanks to reliable technology.



Work economically.

Today, economic efficiency is one of the most important features that Hoftracs® should bring to your business. The faster and more time-saving a wheel loader can manoeuvre, the higher its performance. For Weidemann machines, economic efficiency means technically sophisticated solutions such as large lifting height, strong tensile force, high stability and an efficient rapid-change system for attachments.



Connectible 100% differential lock.

The connectible 100% differential lock provides maximum traction and pushing power if necessary. It also keeps the tire wear low (switched off during normal operation). This increases the efficiency of your machine!

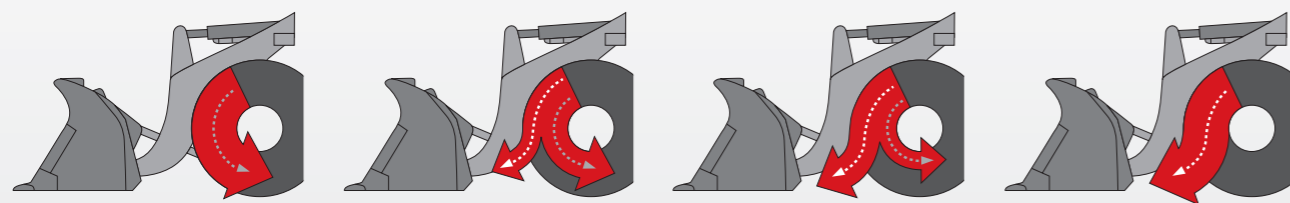

The brake-inch pedal.

In Weidemann machines, the hydrostatic all-wheel drive is combined with the brake pedal. Through the "inching", this enables creeping until standstill. With the brake-inch pedal partially depressed, it is possible to travel at millimeter precision at crawling speed at full engine speed while

quickly lifting. If the pedal is pushed further, the machine will stop. The advantage of the brake-inch pedal is the optimal distribution of the engine output. Stalling of the engine is also not possible.



Perfectly matched kinematics.

The kinematics are adjusted to the size of the machine - this ensures optimal balances of power for every machine. On one hand, the P kinematics is available; its advantage is the exact parallel guidance over the entire lifting range. Based on this, there is a PZ kinematics which is a combination of P kinematics and Z kinematics. It allows significant lifting and shearing forces. See pages 38 - 39 to check which kinematics is available for which machine type.



Increased lifting height and range due to longer load arm.

Depending on the machine type, you can optionally fit out your Hoftrac® with a longer load arm. Due to the longer load arm, you can achieve an increased lifting height and do not need to directly switch to a larger machine if required.



Optimum ease of servicing.

The models of Hoftrac® series are equipped with a tiltable operator's cab or a tiltable cab (exception 1240LP). This allows easy access to the engine, hydraulic system, and electronics. This facilitates inspection and maintenance of the machine. Even the engine hood can be opened widely, thereby allowing optimal access.



Considerable lifting power and tensile forces through an over-sized hydraulic cylinder.

On all Hoftracs®, Weidemann always includes two strong lift cylinders. This ensures that the load distribution is always optimally changed over to the load arm. In addition, the entire loading system gains stability. The size of the hydraulic cylinder is always adapted to the size of the respective machine. This is gentle on both machine and material.

High level of operating and driving comfort.

Optimal visibility and good working environment.



Comfortable working environment.

The working environment is excellent, thanks to an efficiently working heating and ventilation system with a fan, fresh air filter and well-placed air nozzles. In warm ambient temperatures, an air-conditioning system is recommended (available for 1390 and 1880).

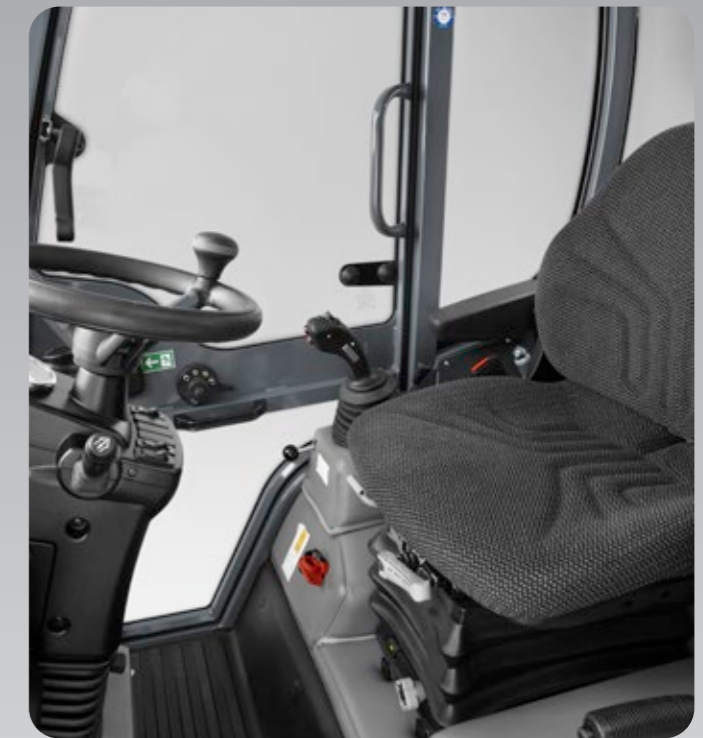

Comfortable operator's seat.

The operator's seat is adjustable, ergonomically formed, and well suspended. The optional air-cushioned comfort seat provides for fatigue-free work. The seats are heated for working in cold conditions.



With its very large provision of space, the new comfort cabin of the 1390 is trendsetting in the Hoftrac® segment. It has been optimised for the operator's requirements, provides a lot of new features and enables a safe and comfortable work environment:

- 4-pillar-design and panoramic rear windscreen for the best all-round visibility.
- Selectable one-piece doors or two-piece doors with adjustable window, gap ventilation possible.
- Cabin suspension with hydro-mounts protect the operator optimally from vibrations and impact.
- Optimised entry with anti-slip step tread which ensure safety upon entry and exit



- Coming-Home lighting increases the safety in the dark.
- New interior: Colour-oriented operating concept and ergonomic, coordinated display ensure safe and comfortable work.
- Height and incline adjustable steering wheel enables ergonomic work for each and every operator.
- Multi-functional joystick with lots of functions, familiar from other wheel loaders.
- Heating and ventilation with optimised air circulation. Optional: efficient air-conditioning system.
- Radio, USB connection, mobile phone holder, cup holder and diverse storage areas.



Ventilation as required.

The cabs possess large, wide-opening doors on both sides. In some models, the upper window can also fold up completely and be locked. A gap ventilation is also possible.

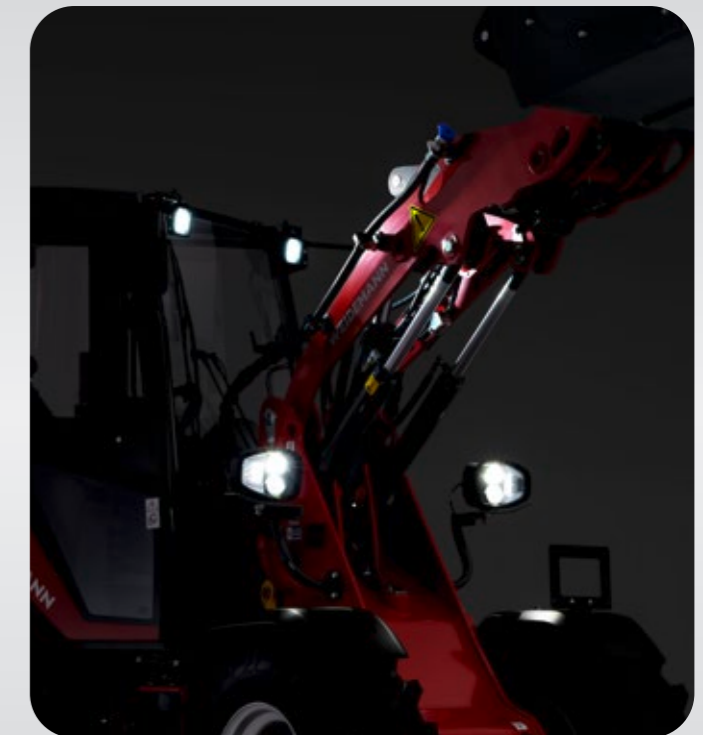

Good all-round visibility and lighting.

The operator's canopy or the cab provides an excellent overview of the attachments, the immediate working area and the entire machine surroundings. The lighting can also be adapted to various requirements (standard lighting, lighting as per StVZO, LED lighting and additional headlamps on the loader unit).

A motivating working area.

Ergonomic operator's controls and simple handling.



Tried and tested and operator-friendly – the joystick for Hoftac® series.

With the multifunction lever or joystick the entire machine can be controlled with one hand. Sturdy and sensitive control for all lifting and lowering movements and for the tilting out and in of the attachment with just one lever. Optionally, the joystick on some models can be supplemented with additional functions.



The joystick for the 1390 and 1880.

The joystick becomes an all-rounder and the machine's ease of use is increased even further. In addition to the functioning of the 3rd proportional control circuit that can be operated on the joystick, the continuous operation of the 3rd control circuit can be activated via a rocker switch – and also in both directions, by moving the thumbwheel.

The optional function of the 4th control circuit can also be operated proportionally via the joystick. Both electrical functions can also be operated on the joystick in a detenting or latching manner. Both electric functions are independent so that they can be individually configured by the operator.



Adjustable steering wheel and steering column.

Thanks to the adjustable steering wheel or steering column, you can adjust the operator's compartment to your physical dimensions. By adjusting the various operator's controls, you can create a completely ergonomic working area.



The main functions always in sight.

With the display, you obtain an overview of your machine. In addition to standard displays like temperature, tank filling, or operating hours, active functions are also displayed in the cab, like activated electrical functions, the continuous operation of the 3rd control circuit, The control circuit or the activated differential lock (varies depending on machine type).

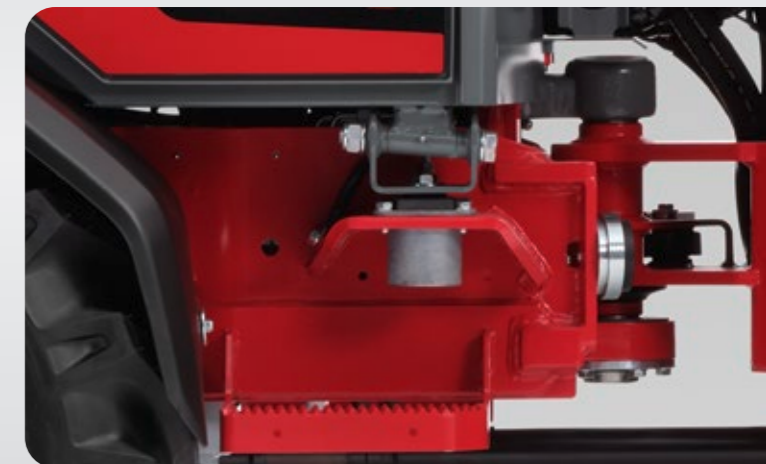

Vibration-damped working area.

Vibrations and impacts are absorbed by the machine. Your body is protected and you work more relaxed and are able to concentrate more for a longer period of time.

The 1160 eHoftrac®

Original Hoftrac. 100% electric.



Original Hoftrac®: The indispensable multitool.

Compact and sturdy design, low centre of gravity, a small turning radius, powerful capacity and a variety of different attachments – these features identify our Hoftrac® and still determine the enormous success. The 1160 eHoftrac® combines the advantages of the traditional Hoftrac® with the drive type of the future.

100% electric: Technology that excites.

A lead-acid battery drives the eHoftrac® to peak performances – and only requires an electrical connection with 230 volts to do so. Two separate electric motors are used in the machine: one for the drive and one for the drive system of the work hydraulics. This minimises the power consumption, because the performance is only drawn when it is really needed. The electric motor for the drive also allows a dynamic and powerful start-up of the machine. This can be felt in every acceleration process.

The 1160 eHoftrac®.

The innovation for your business.

Die Weidemann Hoftracs® are usually deployed for several hours of stable work in early mornings and late evenings. The classic 1160-series Hoftrac® has been used by Weidemann as the first fully electric eHoftrac®. One battery charge suffices for a work application of 2 to 5 hours, depending on the application conditions. This working duration is quite sufficient for machines in such a performance category under normal conditions. The concept of the eHoftrac® is based on a time-tested large-scale technology from materials handling equipment.

Main relay:
Supplies power from the battery to the electric load.

Frequency inverter:
converts the direct current from the battery into a three-phase AC, which is required from both electric motors.

On-board charger:
Enables flexible charging from any 230 V outlet.

Control unit:
Controls the drive system and the work hydraulics.

Battery:
Supplies the required power to both electric motors.

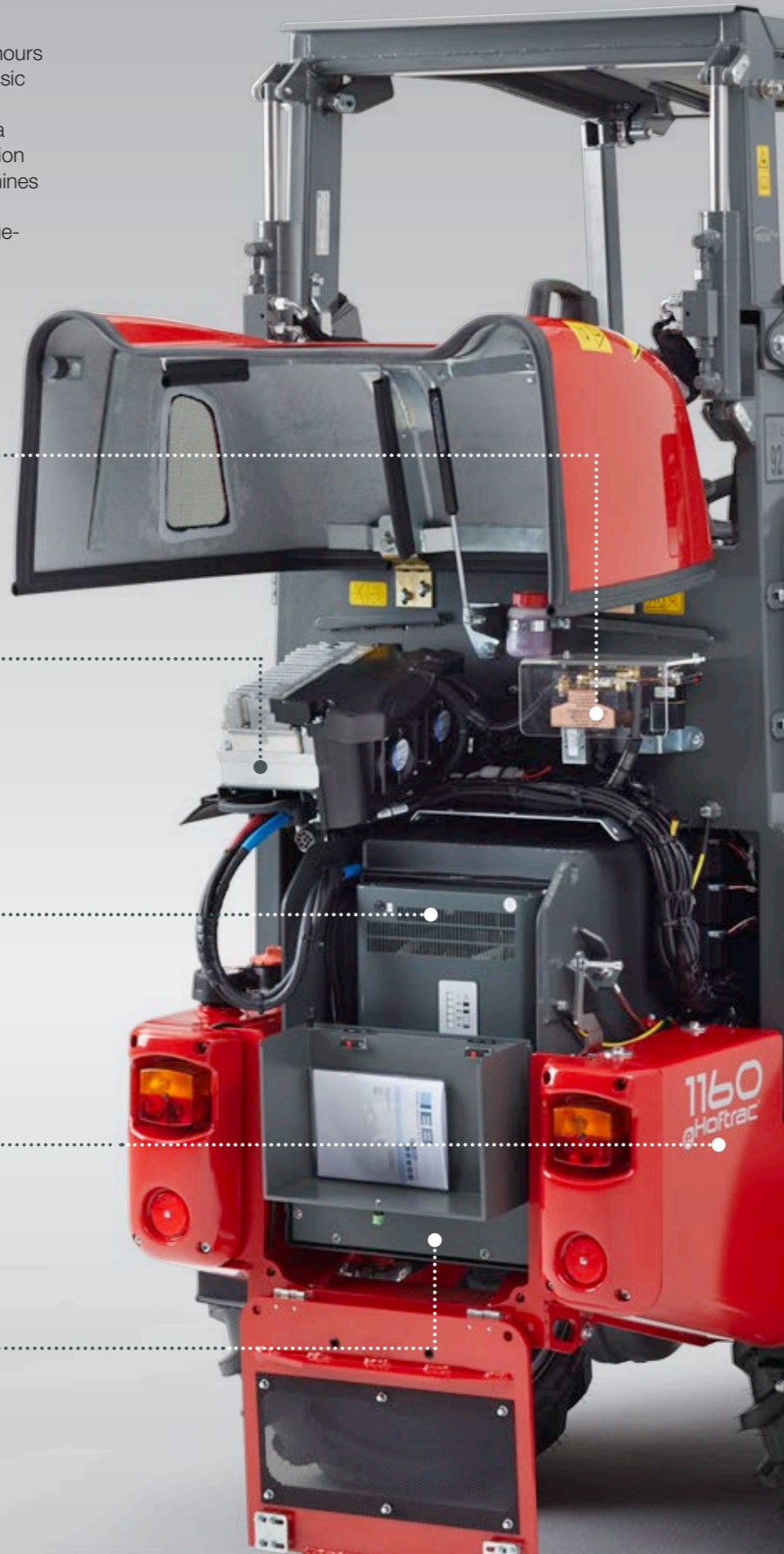

eHoftrac®



The 1160 eHoftrac® has received multiple international awards:

Eima
innovation award 2014
Italy

Agra
innovation award 2015
Bulgaria

Equitana
innovation award 2015
Germany

demo park
innovation award 2015
Germany



Battery technology that convinces.

Work efficiently with AGM technology.

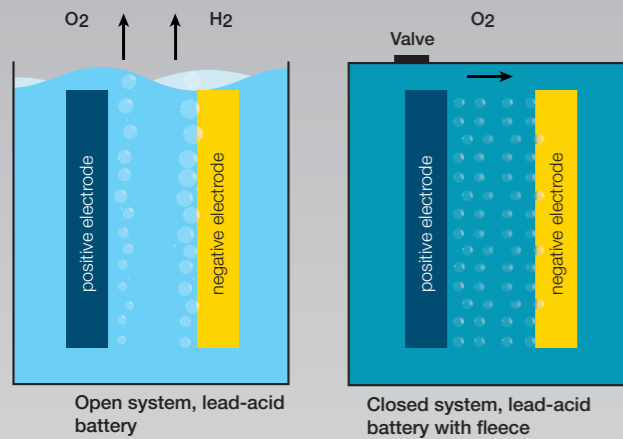

The advantages of the new AGM battery in 1160 eHoftrac®:

- Improved degree of efficiency and better power output with the same capacity
- Leak-proof system thanks to the enclosed battery cells
- No longer necessary to top off the distilled water
- On-board battery charger, charging at any normal plug receptacle with 230 V
- Interim charges are possible at all times and increase the efficiency of the battery
- More safety during the charging process (75% reduced gas formation)
- Increased recuperation capacity (energy recovery)
- Low temperature sensitivity (outside temperature)
- Low heat generation during operation

AGM - Absorbent Glass Mat.

The AGM technology describes a design of a sealed, maintenance-free lead acid battery with internal gas recombination. In order to ensure internal recombination of oxygen and hydrogen ions, it is necessary that oxygen gas generated during the charging is led directly to the negative electrode where it recombines back to water. This movement is almost completely prevented in closed battery cells by the liquid electrolyte due to the differences in density. In closed batteries, fast gas transport

through fleece mats (AGM = Absorbent Glass Mat) is achieved. Smaller pores are wetted by the electrolyte and the larger pores are available for gas transport. Two different batteries are available for the 1160 eHoftrac® - one battery with 48 V and 240 Ah and the other powerful battery with 48 V and 310 Ah.



Environmental friendliness that pays off in the long run.

A comparison of the operating costs over the average service life of the machine indicates that the costs for the diesel drive are significantly higher than those of the eHoftrac®. Included in the consideration were the energy and service costs, as well as the cost of replacing the eHoftrac® battery after about 2,500 operating hours.

equal power. This will pay for itself after about 2,800 operating hours. Emission values are reduced by around 43% by the eHoftrac®, thereby documenting its environmental friendliness. If you add the energy generation and energy consumption from your own PV unit to this, then this would result in even more considerably positive effects.

It can be said that the increased investment costs for the eHoftrac® are about 20% when compared with a machine of

Contact your Weidmann dealer to find out about the costs for you and your business.



Operating costs over the service life of the machine

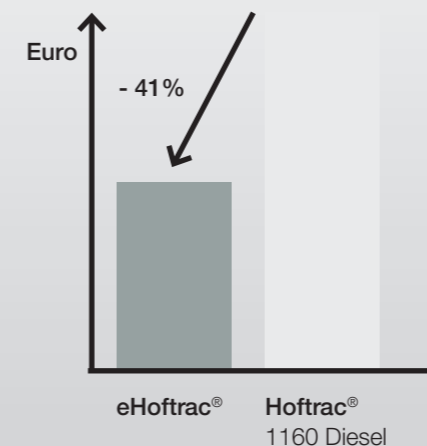

CO₂ emission over service life of the machine

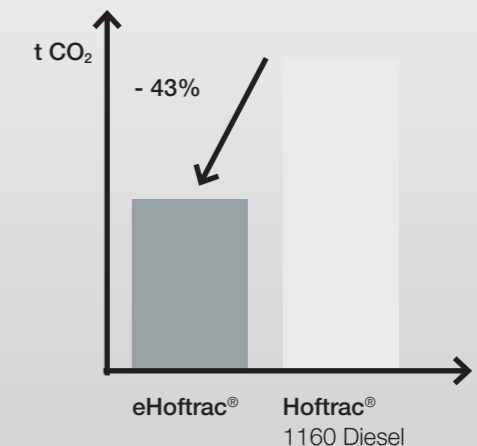



Our quality promise.

Weidemann offers true German-made quality.

At Weidemann, quality is not an empty promise. A true Weidemann comes from one of the most modern wheel and telehandler production facilities in Europe. The plant in Korbach guarantees a consistently high quality of our products. At Weidemann, quality begins early on because compliance with defined processes is taken seriously. Purchased parts supplied to production are continually monitored, tested, and optimised in co-operation with suppliers.

Powder-coating.

The powder-coating is another key feature of the special quality standard at Weidemann. This guarantees optimum protection against corrosion. In comparison to conventional wet painting, it greatly extends the service life of the machine. It is also more efficient and environmentally friendly.



Careful final inspection.

Every Weidemann that leaves our factory is subjected to a careful final inspection. This guarantees our customers a long service life and low operating costs from the onset. The Weidemann label means quality.



DIN EN ISO 9001.

This standard is recognised internationally. With a certified quality system in accordance with international standard ISO 9001, Weidemann proves that a focus on quality is reflected in all thoughts and actions within the company and that customers receive certified quality in all areas.



Weidemann Hoftracs®.
Unbeatable in daily application.



Weidemann Hoftracs®.

Unbeatable in daily application.



The optimal attachment for every task.

Your machine becomes a multi-tool.

Only the right attachment makes our machines into true problem solvers for your respective work task. With the richly varied and well-thought-out product range, our machines become highly functional multi-tools that meet any application. See here a selection of attachments and activities, which can be easily completed using those.

Material Handling

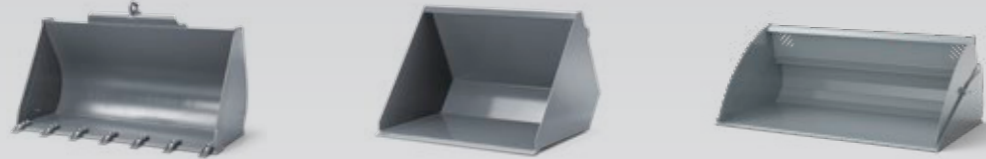

Gripping



Grab fork



Stacking and Transporting



Cleaning



Mowing and mulching



Trimming trees and hedges



Winter services



Feed handling



Bale handling



Stable work



Silage handling



Equestrian business



You can find all ex works attachments at: www.weidemann.de

You can obtain more information from your Weidemann distributor.

The matching options for your business.

Individual, need-based and economical.



A separate 4th control circuit that must be operated independently and individually:

The machine is equipped with a dual-acting auxiliary control circuit.

Advantage:

- Allows the use of hydraulically activated attachments with several connections and functions (e.g. a round bale stacking device or snow blower).



Speed increase to 30 km/h:

The machine is equipped with a speed of 30 km/h.

Advantage:

- Faster transposing of the machine is possible.
- Time savings and increased economic efficiency.



Electrical connections (front and rear):

Connections for electrically-driven additional functions of attachments (such as rotary sweeper with water spray device).

Advantage:

- This makes the operation of electrically-driven additional functions for attachments possible.
- This makes it possible to switch over from additional functions of hydraulic attachments.

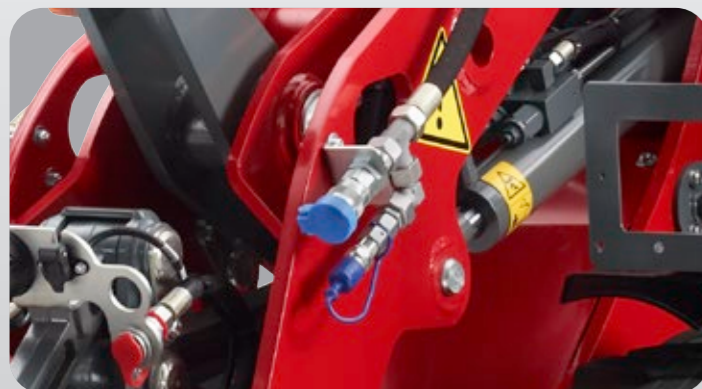

High Flow:

The machine is equipped with High-Flow high performance-hydraulics.

Advantage:

- Enables operation of front attachments demanding a lot of oil (like a snow blower).



Hand-inching:

With the low-speed control, very slow travel speeds can be achieved at a constant engine speed.

Advantage:

- When using attachments that, for example, are operated with a constant high rpm but simultaneously with a very low travel speed (e.g. a rotary sweeper), you do not have to constantly operate the foot inching pedal.



Counterweight:

The machine is made heavier by a counterweight (floor plate on the rear carriage) and cast rear weight.

Advantage:

- A higher tipping load is achieved and heavier loads can be transported with the same dimensions.



Dual tyres:

Equipped with two additional tyres on the front axle.

Advantage:

- Additional tyres widen the front axle, resulting in greater stability.



Pressureless return:

The hydraulic oil flows back into the hydraulic oil tank in a separate line via the hydraulic filter.

Advantage:

- Attachments with own hydraulic motors can return the return oil without increased back pressure into the hydraulic oil tank.

No Hoftrac® is the same as another.

Just put your machines together ...

It's not a multitude of models that decides which problem solutions are optimal, but rather the individual machine equipment for each area of use. Our base models, Hoftrac® series offer you economical entry models. In addition, there is a LP-Hoftrac with especially low overall height. Simply choose from our options tailored to suit your needs and assemble your machine according to your tasks and operational requirements. And the best thing about the Hoftrac® concept: You only pay for the configuration of your individual machine, that is, only what you really need. On the following pages, you can find the standard equipment and options, as well as the technical data and dimensions for our Hoftrac® series.



1140
1140 Basic Line



1240 LP



1160



1160 eHoftrac®



1280



1390



1880

This brochure is for general product information. If you are interested, one of our distributors would be happy to send you an offer. The descriptions, illustrations and technical data are not binding and do not necessarily represent the standard design. We reserve the right to make changes. Despite the greatest care and diligence applied, we cannot rule out deviations from the images or measures, errors in calculation, misprints or omissions in this brochure. We therefore assume no liability for the accuracy and completeness of our information in this brochure.

Standard equipment and options.

	1140	1140	1160	1240LP	1280	1390	1880
DRIVE SYSTEM							
Hydraulic drive system via oil engine	●	●	-	-	-	-	-
Hydrostatic drive via oil engine	○	○	●	●	-	-	-
Hydrostatic drive via transfer gearbox and universal joint shaft	-	-	○	-	●	-	●
ecDrive: electronic controlled drive, hydrostatic through PTO gear and driveshaft	-	-	-	-	-	●	-
Axle K75	●	●	-	-	-	-	-
Axle K80	-	-	●	●	-	-	-
Axle K90	○	○	-	○	-	-	-
Axle T80	-	-	○	-	-	-	-
Axle T94	-	-	○	-	●	●	-
Planetary axle PA940	-	-	-	-	-	○	●
100% differential lock, electric-hydraulically connectible on front and rear axle	-	-	○	-	○	○	●
HYDRAULICS							
3. control circuit front, DN10	●	●	●	●	●	-	-
3. control circuit front, DN12	-	○	○	○	○	●	●
3. front control circuit, electric, proportional	-	-	-	-	-	○	●
3. control circuit	○	○	○	○	○	○	-
4. control circuit	-	○	○	○	○	○	-
4. control circuit additional	-	○	○	○	○	○	○
High Flow (84 l)	-	-	-	-	-	○	-
High Flow (100 l)	-	-	-	-	-	-	○
Work hydraulics of large pump (depending on model, between 58.5 l and 70l)	-	-	-	-	-	○	○
Rear hydraulic connection, also single-acting	-	○	○	-	○	-	-
Rear hydraulic connection, also dual-acting	-	-	○	-	○	○	○
OPERATOR'S CAB							
Operator's canopy with retaining system ROPS and FOPS tested	●	●	●	●	●	●	●
Front window (for standard operator's canopy)	-	○	○	-	-	○	○
Rear window (for standard operator's canopy)	-	○	○	-	-	○	●
Easy Protection System (eps) ROPS and FOPS tested	○	○	○	-	○	○	-
Easy Protection System Plus (epsPlus) ROPS and FOPS tested	-	-	○	-	-	-	-
Cab with heating, ventilation, and windscreen; ROPS and FOPS tested	-	-	○	○	○	○	○
Laterally tiltable operator's cab	●	●	●	-	●	●	●
Comfort seat with safety belt mechanically suspended	●	●	●	●	●	●	●
Comfort seat with safety belt air-suspended	-	-	○	○	○	○	○
Heated seat	-	○	○	○	○	○	○
Lighting system according to StVZO	○	○	○	○	○	○	○
Air-conditioning system	-	-	-	-	-	○	○
OTHER							
Weight of cast iron rear including self-recovery feature	-	-	○	-	○	●	-
Counterweight	○	○	○	○	○	○	-
Mechanical rapid-change system for attachments	●	●	●	-	●	-	-
Hydraulic rapid-change system for attachments	○	○	○	●	○	●	●
ecs (Easy Coupler System)	○	○	○	○	○	○	-
High lifting height (long load arm)	-	-	○	○	○	○	-
TÜV [Industrial Supervisory Board] certificate for driving on public roads	-	○	○	○	○	○	○

- Series
- Option
- Not possible

The illustration shows a selection of standard equipment and options. More detailed information about standard equipment and options can be obtained from your Weidemann distributor. More information can be found at www.weidemann.de

Technical data.

	1140 1140 Basic Line	1160	1240LP	1280	1390	1880
ENGINE DATA						
Engine manufacturer	Perkins	Perkins	Perkins	Perkins	Yanmar	Perkins
Type of motor	403 J-11	403 J-11	403 J-17	403 J-17	3TNV80FT	404J-E22T
Cylinders	3	3	3	3	3	4
Max engine output kW	18.4	18.4	18.4	18.4	18.4	45
Max engine output HP	25	25	25	25	25	61
At max. speed rpm	2,800	2,800	2,800	2,800	2,600	2,800
Capacity cm ³	1,131	1,131	1,663	1,663	1,226	2,200
Type of coolant	Water	Water	Water	Water	Water	Water
Emissions standard level	V	V	V	V	V	V
Exhaust after-treatment	-	-	-	-	-	DOC/DPF
ENGINE DATA (OPTIONAL)						
Engine manufacturer	-	-	-	-	Yanmar	-
Type of motor	-	-	-	-	3TNV86CHT	-
Cylinders	-	-	-	-	3	-
Max engine output kW	-	-	-	-	33.3 / 40.1	-
Max engine output HP	-	-	-	-	45.3 / 54.5	-
At max. speed rpm	-	-	-	-	2,600	-
Capacity cm ³	-	-	-	-	1,568	-
Type of coolant	-	-	-	-	Water	-
Emissions standard level	-	-	-	-	V	-
Exhaust after-treatment	-	-	-	-	DOC/DPF	-
ELECTRICAL SYSTEM						
Operating voltage V	12	12	12	12	12	12
Battery Ah	77	77	77	77	77	95
Alternator A	40	40	65	65	80	85
WEIGHTS						
Operating weight (standard) kg	1,630	1,910-2,250*	1,840	2,380-2,550*	2,750-3,200*	3,400
Tipping load with bucket – machine straight (in accordance with ISO 14397) kg	664-733*	1,074-1,437*	1,169-1,257*	1,385-1,781*	1,610-2,100*	2,032-2,269*
Tipping load with bucket – machine at an angle (in accordance with ISO 14397) kg	490-554*	815-1,206*	999-1,065*	1,154-1,478*	1,340-1,790*	1,692-1,898*
Tipping load with pallet fork – machine straight (in accordance with ISO 14397) kg	532-538*	829-970*	899-969*	1,081-1,401*	1,560-1,950*	1,731-1,908*
Tipping load with pallet fork – machine at an angle (in accordance with ISO 14397) kg	391-398*	631-866*	767-822*	981-1,152*	1,310-1,680*	1,459-1,605*
VEHICLE DATA						
Operator's cab (optional)	FSD (eps)	FSD (eps, epsPlus, cabin)	FSD (cabin)	FSD (eps, cabin)	FSD (eps, cabin)	FSD (cabin)
Axle (optional)	K75 (K90)	K80 (T80, T94)	K80	T94	T94 (PA940)	PA940
Kinematics (optional)	P	P	P	P	P (P-Z)	P-Z
Travel speed (optional) km/h	0-12 (13)	0-13 (20)	0-13	0-20	0-20 (30)	0-20 (28)
Fuel tank capacity l	21	20	21	45	50	65
Hydraulic oil tank capacity l	18	20	12	27	30	35
HYDRAULIC SYSTEM						
Drive hydraulics – working pressure (optional) bar	215 (305)	305	305	370	380 (400-470)	450
Work hydraulics – discharge volume (optional) l/min	30.8	30.8	44.8	44.8	41.6 (49.5-84)	56 (70-100)
Work hydraulics– working pressure bar	205	225	185	185	210	210
DRIVE SYSTEM						
Drive type (optional)	Hydraulic (hydrostatic)	Hydrostatically	Hydrostatically	Hydrostatically	ecDrive (electronic controlled drive)	Hydrostatically
Drive system (optional)	Oil engine	Oil engine (universal joint shaft)	Oil engine	Universal joint shaft	Hydrostatic through PTO gear driveshaft	Universal joint shaft
SOUND PARAMETERS						
Averaged sound power level LwA dB (A)	99.7	98.4	100.1	99.7	99	99.8
Guaranteed sound power level LwA dB (A)	101	101	101	101	101	101
Specified sound pressure level LpA dB (A)	85	85	84	82	84	82

*With optional equipment (e.g. cab, axle, tyres, counterweight, cast rear weight etc.)

FSD = Operator's canopy

eps = Easy Protection System (foldable operator's canopy)

epsPlus = Easy Protection System Plus (hydraulically lowerable operator's canopy)

DPF = Diesel particle filter

DOC = Diesel oxidation catalyst

There may be short-term changes in the engines because of the constantly evolving emission standards. For current availabilities, you can contact your Weidemann distributor.

More information can be found at www.weidemann.de

	1160 eHoftrac®
ELECTRIC MOTOR	
Motor for drive hydraulics kW	6.5
Motor for work hydraulics kW	8.5
STANDARD BATTERY	
Battery voltage V	48
Nominal capacity K5 Ah	230
Battery weight (±5%) kg	450
Charging time h	8
Runtime for hard long-time application with heavy material handling, uninterrupted operation h	1.5*
Runtime for normal agricultural activities uninterrupted operation h	2–3.5*
Runtime for normal agricultural activities with interruptions (30 min. driving time, 30 min. standstill) h	to 4*
BATTERY OPTIONAL	
Battery voltage V	48
Nominal capacity K5 Ah	310
Battery weight (±5%) kg	579
Charging time h	6
Runtime for hard long-time application with heavy material handling, uninterrupted operation h	2.1*
Runtime for normal agricultural activities uninterrupted operation h	2.8–4.5*
Runtime for normal agricultural activities with interruptions (30 min. driving time, 30 min. standstill) h	to 5*
ELECTRICAL SYSTEM	
Operating voltage V	12
WEIGHTS	
Operating weight (standard) kg	2,400
Tipping load with bucket - machine straight (according to ISO 14397) kg	1509 -1576
Tipping load with bucket – machine at an angle (according to ISO 14397) kg	1,251-1,307
Tipping load with pallet fork – machine straight (according to ISO 14397) kg	1,112-1,163
Tipping load with pallet fork – machine at an angle (according to ISO 14397) kg	916-959
VEHICLE DATA	
Axle	T80
Operator's compartment (optional)	FSD (eps, epsPlus)
Driving speed km/h	0–15
Hydraulic oil tank capacity l	18.5
HYDRAULIC SYSTEM	
Work hydraulics	
Discharge volume (optional) l/min	32
Working pressure bar	225
DRIVE SYSTEM	
Drive type/drive system	electrical and Universal joint shaft
NOISE CHARACTERISTIC VALUES	
Average sound power level LwA dB (A)	91.8
Guaranteed sound power level LwA dB (A)	92
Specified sound pressure level LwA dB (A)	76

*The runtimes of the battery are strongly dependent on the respective application conditions, the work task and the manner of driving. This can also mean that a longer runtime can also be achieved. The specified running times can also be fallen short of in extreme cases. An uninterrupted operation (e.g. 30 min. of driving, 30 min. of standstill), for example, extends the total runtime of the battery.

Standard equipment and options.

	1160 eHoftrac®
DRIVE SYSTEM	
Electric drive via universal joint shaft	●
Active standstill regulation (the machine is held by the engine)	●
Hill-hold function (the machine is held on a hill by the engine)	●
Weidemann axle T80	●
BATTERY	
Battery 48 V 230 Ah	○
Battery 48 V 310 Ah	○
On-board battery charger 230 V / 40 A	●
Battery charge indicator	●
STANDARD TYRES (FOR MORE INFORMATION, SEE PAGE 40)	
Tyres 10.0/75 - 15 AS ET10	●
HYDRAULICS	
3. control circuit front, DN10	●
Unpressurised return line, front	○
3. control circuit	○
4. control circuit	○
Hydraulic connection in rear, dual acting	○
Faster rapid action couplings attachment or machine side	○
OPERATOR'S CAB	
Operator's canopy with restraint system	●
eps (Easy Protection System)	○
epsPlus (Easy Protection System Plus)	○
Plug receptacle in front, 3-pin, dual function	○
Adjustable steering column	○
LED work lights 2 front, 1 rear	○
Comfort seat with safety belt mechanically suspended	●
Operating hour meter	●
Lighting system according to StVZO	○
OTHER	
Fender front	●
Fender rear	●
Mechanical quickhitch system for attachments	●
Hydraulic quickhitch system for attachments	○
High lifting height	○
Self-recovery coupling	○
TÜV [Industrial Supervisory Board] certificate for driving on public roads	○

● Standard
○ Option



Dimensions.

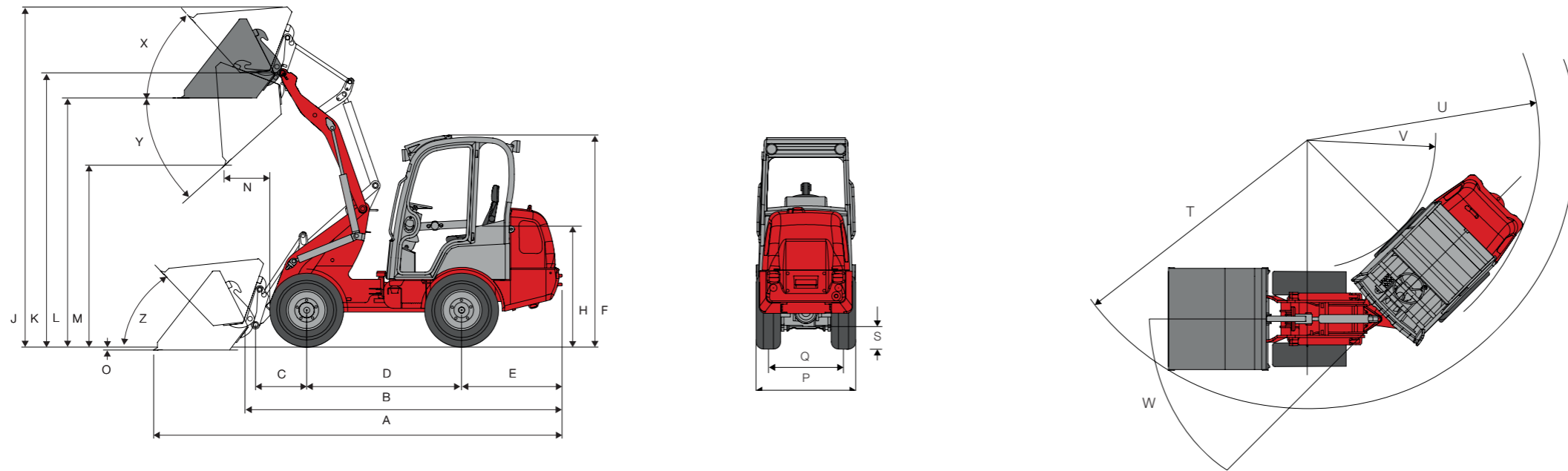

	1140	1160	1160 eHoftrac®	1240LP	1280	1390 P-kinematics	1390 PZ-kinematics	1880
	1140 Basic Line							

DIMENSIONS

	1140	1160	1160 eHoftrac®	1240LP	1280	1390 P-kinematics	1390 PZ-kinematics	1880
Tires	7.00 - 12 AS ET40	10.0 / 75 - 15.3 AS ET10	10.0 / 75 - 15.3 AS ET10	27 x 8.50 - 15 EM ET30	10.0 / 75 - 15.3 AS ET80	10.0/75 - 15.3 AS ET40	10.0/75 - 15.3 AS ET40	10.0 / 75 - 15AS ET-5
A Total length mm	3,706	3,983	3,983	4,142	4,053	4,470	4,630	5,007
B Total length (without bucket) mm	2,733	3,005	3,005	3,164	3,321	3,570	3,730	4,022
C Bucket pivotal point (to axle centre) mm	496	508	508	620	534	603	720	675
D Wheel base mm	1,345	1,468	1,468	1,544	1,623	1,732	1,732	1,952
E Rear overhang mm	779	917	917	889	1,054	1,230	1,230	1,290
F Height with fixed driver protection roof mm	2,124	2,237	2,257	1,891	2,255	2,320	2,320	2,336
Height of folding operator's canopy (eps) in mm	2,227	2,341	2,361	-	2,373	2,375	2,375	-
Height of folding operator's canopy (eps), down in mm	1,937	1,928	1,948	-	1,856	1,870	1,870	-
Height with operator's canopy lowering (epsPlus) mm	-	2,243	2,263	-	-	-	-	-
Height with operator's canopy lowering (epsPlus), lowered mm	-	1,949	1,969	-	-	-	-	-
Height with cabin mm	-	2,302	-	1,950	2,280	2,340	2,340	2,346
H Seat height mm	1,142	1,273	1,293	937 (976*)	1,320	1,330	1,330	1,349
J Total working height mm	3,415	3,423	3,443	3,071	3,461	3,660	3,830	3,675
K Max. height of bucket pivotal point mm	2,734	2,740	2,760	2,386	2,872	3,004	3,200	3,203
L Overhead loading height mm	2,405	2,421	2,441	2,049	2,544	2,680	2,880	2,861
M Dumping height mm	1,807	1,799	1,819	1,404	2,067	2,120	2,380	2,454
N Coverage for M mm	550	498	498	467	447	250	410	198
O Digging depth mm	113	97	77	101	37	80	127	104
P Total width mm	850	1,044	1,044	960	1,044	1,124	1,124	1,214
Q Track width mm	660	780	780	740	780	860	860	950
S Ground clearance mm	190	255	255	226	230	250	250	270
T Max. radius outside mm	2,140	2,592 (2,831*)	2,592	3,034 (3,217)	2,846	3,000	3,340	3,447
U Radius on outer edge mm	1,570	2,138 (2,415*)	2,138	2,607 (2,843*)	2,546	2,710	2,980	3,171
V Inner radius mm	600	1,017 (1,311*)	1,017	1,561 (1,775*)	1,423	1,560	1,850	1,831
W Articulation angle °	55°	50° (43°*)	50°	41° (40°*)	45°	45°	40°	45°
X Rollback angle at max. lifting height °	50°	50°	50°	48°	47°	42°	57°	52°
Y Max. dumping angle °	39°	40°	40°	44°	44°	43°	37°	41°
Z Rollback angle on bottom °	48°	49°	49°	52°	48°	51°	50°	42°

Tires.

AXLE

TIRES

7.00-12 AS ET40
10.0/75-15.3 AS ET-5
10.0/75-15.3 AS ET10
10.0/75-15.3 AS ET40
10.0/75-15.3 AS ET80
10.0/75-15.3 RP ET40 Mitas M159
10-16.5 EM ET0
10-16.5 EM ET40
10-16.5 Sure Trax ET0 BKT
10-16.5 Sure Trax ET40 BKT
11.5/80-15.3 AS ET-5
11.5/80-15.3 AS ET40
12-16.5 EM ET0
12-16.5 EM ET45
12-16.5 Sure Trax ET0 BKT
12-16.5 Sure Trax ET45 BKT
12.0/75-18 MPT ET-30
15.0/55-17 AS ET0
15.0/55-17 AS ET-40
26.0x12.00-12 AS ET0
26.0x12.00-12 RP ET0
27x8.50-15 EM ET30
27x8.50-15 EM ET80
27x10.50-15 EM ET-5
27x10.50-15 EM ET18
27x10.50-15 EM ET60
27x10.0-15.3 AS504 ET0
31x15.50-15 AS ET-50
31x15.50-15 AS ET-50 Starco
31x15.50-15 AS ET-37
31x15.50-15 AS ET-37 Starco
31x15.50-15 AS ET0
31x15.50-15 AS ET0 Starco
31x15.50-15 AS ET-85
31x15.50-15 EM ET-37
31x15.50-15 EM ET0
31x13.50-15 RP ET0
31x15.50-15 RP ET0
31x15.50-15 RP ET-37
33x15.50-15 RP ET-37
260/70R16.5 Michel.BibSt ET-60
260/70 R16.5 ET-60 Michelin BIBSTEEL Hard Surface
305/70 R16.5 ET0 Multiuse 550
315/55R16 Conti MPT81 ET-30
425/55 R 17 AS ET-40 Alliance 570
425/40 B17 ET0 PR14 Delcora GSP+
425/40 B17 ET0 PR22 Delcora GSP+
Dual tires 7.00-12 AS front
Dual tires 10.0/75-15.3 AS front
Dual tires 27x8.50-15 EM front
Dual tires 11.5/80-15.3 AS front

Standard tires

1140 Basic Line 1140		1160		1160 eHoftrac	1240LP		1280	1390	1880
K75	K90	K80/T80	T94	T80	K80	K90	T94	T94/PA940	PA940
Width of machine mm									
850	1,000	-	-	-	-	-	-	-	-
-	-	-	-	-	-	-	1,214	1,214	1,214
-	-	1,044	-	1,044	-	-	-	-	-
-	-	-	-	-	-	-	1,124/1,300	1,124/1,300	-
-	-	-	1,040 / 1,380	-	-	-	1,044/1,380	1,044	-
-	-	-	1,124	-	-	-	1,124	-	-
-	-	-	-	-	-	-	1,200	-	1,200
-	-	-	1,114 / 1,300	-	-	-	1,114/1,300	1,114	-
-	-	-	-	-	-	-	1,200	-	1,200
-	-	-	-	-	-	-	1,128/1,300	1,128/1,300	-
-	-	-	-	-	-	-	-	-	1,240
-	-	-	-	-	-	-	-	1,150/1,340	-
-	-	-	-	-	-	-	-	-	1,250
-	-	-	-	-	-	-	-	1,155/1,350	-
-	-	-	-	-	-	-	-	-	1,270
-	-	-	-	-	-	-	-	1,175/1,370	-
-	-	-	-	-	-	-	-	-	1,300
-	-	-	-	-	-	-	-	1,310	-
-	-	-	-	-	-	-	-	1,400	1,400
1,070	1,250	1,110	-	1,110	1,110	1,210	-	-	-
1,070	1,220	1,110	-	1,110	1,110	1,210	-	-	-
920	1,070	960/1,090	-	960/1,090	960/1,090	1,060	-	-	-
-	-	-	1,000 / 1,340	-	-	-	1,000/1,340	-	-
1,000	1,150	1,080	-	1,080	1,080	1,180	-	-	-
-	-	-	-	-	-	-	1,160	-	-
-	-	-	1,080 / 1,340	-	-	-	1,080/1,330	-	-
-	-	1,050	-	1,050	1,050	1,150	-	-	-
-	-	1,280	-	1,280	-	-	-	-	-
-	-	1,280	-	1,280	-	-	-	-	-
-	-	-	-	-	-	-	1,394	1,394	1,394
-	-	-	-	-	-	-	1,368	1,394	1,368
-	-	-	1,320	-	-	-	1,320	1,310	-
-	-	-	1,294	-	-	-	1,294	1,320	-
-	-	-	-	-	-	-	-	-	1,490
-	-	-	-	-	-	-	1,414	1,414	1,414
-	-	-	-	-	-	-	1,340	1,340	-
-	-	-	-	-	-	-	-	1,345	-
-	-	-	1,313	-	-	-	1,313	-	-
-	-	-	-	-	-	-	-	1,418	-
-	-	-	-	-	-	-	-	1,424	1,424
-	-	-	-	-	-	-	-	1,326	-
-	-	1,190	1,330	1,190	-	-	1,330	-	-
-	-	-	-	-	-	-	-	1,244	-
-	-	-	-	-	-	-	-	1,302	-
-	-	-	-	-	-	-	-	1,445	1,445
-	-	-	-	-	-	-	-	1,365	-
-	-	-	-	-	-	-	-	1,365	-
1,390	-	-	-	-	-	-	-	-	-
-	-	-	1,650	-	-	-	1,650	-	-
-	-	-	1,650	-	-	-	1,650	-	-
-	-	-	-	-	-	-	-	1,780	-

Tire treads.



EM treads
Thanks to the almost parallel lamellas, the EM tread is particularly well suited for loose ground such as sand, soil or gravel. Thanks to the high thrust transmission, this tyre has a large footprint and runs very smoothly on the road.



AS treads
The tapered lamellas ensure safe driving, especially on smeary and dirty terrain.



SureTrax treads
The SureTrax tread impresses with a large contact surface as well as a high lift capacity. It is ideal for solid and other hard surfaces.



Bibload treads
The Bibload tread offers high level of running smoothness and high mileage due to large ground contact area. Furthermore, the staggered tread blocks ensure optimum traction. The tread is further characterised by high wear resistance.



RP treads
Due to the large contact surface, the ground is traversed gently. This makes the RP tread particularly suitable for application on lawns.



MPT treads
The MPT profile offers the perfect combination of good traction on uneven ground conditions as well as fast road crossings.



Multi-use treads
The multi-use tread was specially designed for year-round use and various climate conditions. In summer, it provides good traction on loose surfaces. In winter, it offers stability on snow and slippery driving surfaces.

Vibration characteristic values.

Typical operating conditions	Mean value			Standard deviation (s)		
	$1,4 \cdot a_{w,eqx}$ [m/s ²]	$1,4 \cdot a_{w,eqy}$ [m/s ²]	$a_{w,eqz}$ [m/s ²]	$1,4 \cdot s_x$ [m/s ²]	$1,4 \cdot s_y$ [m/s ²]	s_z [m/s ²]
Compact wheel loader (operating weight < 4,500 kg)	0.94	0.86	0.65	0.27	0.29	0.13
Wheel loader (operating weight > 4,500 kg)	0.84	0.81	0.52	0.23	0.20	0.14
Application in quarrying (harsh application conditions)	1.27	0.79	0.81	0.47	0.31	0.47
Delivery drive	0.76	0.91	0.29	0.33	0.35	0.17
V-operation	0.99	0.84	0.54	0.29	0.32	0.14

Whole-body vibrations:

- Each machine is equipped with an operator's seat that meets the requirements of EN ISO 7096:2000.
- When the loader is properly used, whole body vibration varies from below 0.5 m/s² up to a short-term maximum value.
- To calculate the vibration values according to ISO/TR 25398:2006, it is recommended to use the values specified in the table. The actual application conditions are to be considered.

- Like wheel loaders, telehandlers are to be classified according to operating weight.

Hand-arm vibrations:

- The hand-arm vibrations are no more than 2.5 m/s².



WEIDEMANN

designed for work

Weidemann – traditionally efficient.

For decades, our mission has been to lighten the load of commercial agriculture by the mechanisation of stable and yard operations. This led to the design and development of the Hoftrac®, which has become a generic term for its own equipment category – the original comes from Weidemann. The close co-operation between the Weidemann developers and our end users has repeatedly led to innovative concepts and a sophisticated product programme with high usability and mature technology.

We stand by this and continue to pursue our chosen path. Our customers benefit from high productivity, investment security and have a strong partner in Weidemann, who is always at their side. Our machines and services perform at a high level and inspire in daily work. Made precisely for this. Weidemann – designed for work.



Weidemann, your strong partner.

All-round care.



Comprehensive dealer network.

Weidemann has a wide network of select dealers in Germany and Europe. Each dealer is part of a well-organised system. In addition to consulting and selling new machines, our dealers are happy to provide you with reliable customer service and supply you with spare parts. Weidemann offers regular training for dealers so that your contact partners are always up to date.

Attractive financing programme.

In Germany, Weidemann offers attractive options for financing or leasing machines thanks to various framework agreements. Weidemann distributors also offer various financing options at the international level. Get in touch with your local contact partner to find out about current conditions.



Personal training and instruction.

When you decide to purchase a Weidemann machine, you will not be left in the dark. When the machine is handed over, you and your entire team will receive detailed instructions on the operation and maintenance of the machine. If you would like to know more, simply contact your dealer. He or she is just around the corner and will be happy to help without bureaucracy.

In the spare parts sector, speed is of the essence.

As our Weidemann machines are generally in everyday use with you, your machine must be repaired for you as quickly as possible as and when required. Weidemann offers a head office spare parts warehouse for this and provides the specialist dealers an electronic 24hr order service and delivery within 24hr in Europe. Many of our dealers have developed their own well arranged spare parts and maintenance item store beyond this so that the most common parts are on-site.



WEIDEMANN

designed for work

The Weidemann product range.



The multifunction Hoftracs®.
Powerful helper for every application.
Our innovation: the fully electric 1160 eHoftrac®.



The powerful wheel loader.
Available either with load arm or telescopic arm.



The compact telehandler.
Aim high with optimal stability.



Attachments and tires.
Your Weidemann machine becomes a multi-tool!
The optimal attachment and the right tyres for every task.



WM.EMEA.10252.V03.EN-GB/04/2021

Weidemann GmbH

Elfringhäuser Weg 24

34497 Korbach

Germany

Tel. +49(0)5631 50 16 94 0

Fax +49(0)5631 50 16 94 666

info@weidemann.de

www.weidemann.de