

101110E-10

T-CLAMP 1 1/4" X 1 1/4" (BOX OF 10)

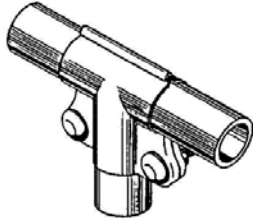

101165-10

2 PC. X-OVER CLAMP - 1 5/8" (BOX OF 10)

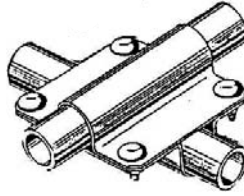

101166-10

X-OVER CLAMP - 1 5/8" X 2 3/8" (BOX 10)

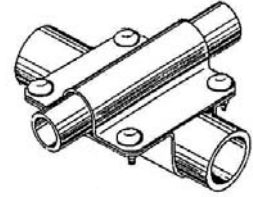

101167-10

X-OVER CLAMP - 2 3/8" (BOX OF 10)

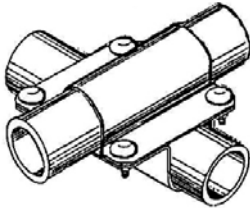

101160X-10

1 PC. X-OVER CLAMP - 1 5/8" (BOX OF 10)

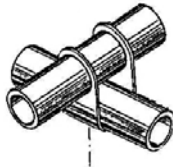

101190U-10

2-BOLT HEADRAIL CLAMP (BOX OF 10)

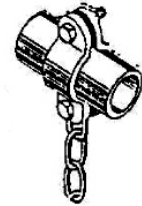

101195U-10

1 BOLT HEADRAIL CLAMP (BOX OF 10)

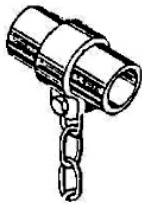

1011540-10

X-OVER 3.5" X 2 3/8" BX/10

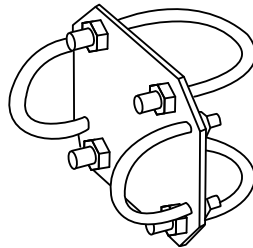

2070994-20

X-OVER 7/8" X 1 1/16" OD (BOX OF 20)

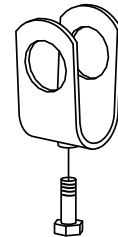

101169-10

HD X-OVER (U-BOLT) 2 3/8" X 1 5/8"
(BOX OF 10)

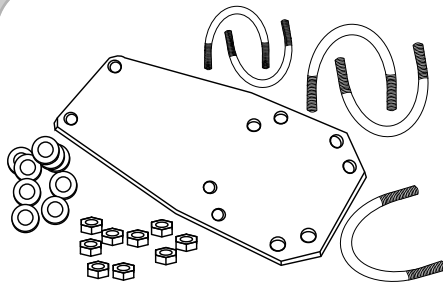

101179-10

DIAMOND HEAD RAIL CLAMP
6 1/2" SQ. PL. + U-BOLTS

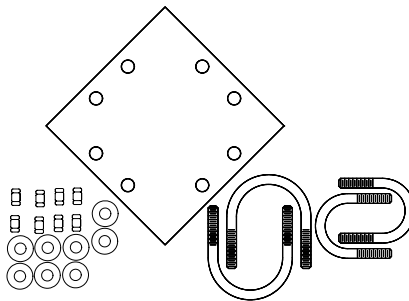

MISCELLANEOUS U-BOLTS

SEE CLAMPS P1

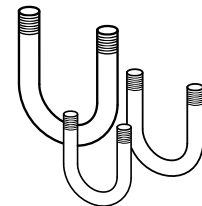

CL-90240043

2 3/8" x 1 5/8" One Bolt T-Clamp

CL-90240063

2 3/8" x 2 3/8" One Bolt T-Clamp

CL-90240023

1 5/8" x 1 5/8" One Bolt T-Clamp

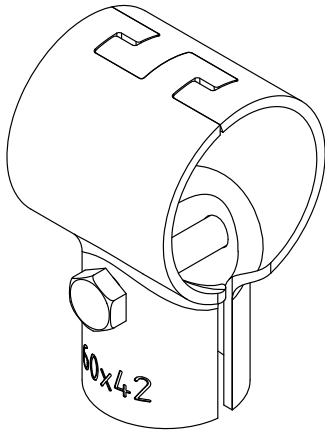

CL-90360013

1 5/8" x 1 5/8" Three Bolt T-Clamp

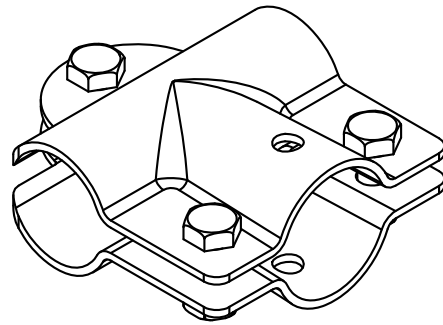

NEW

CL-90020053

1 5/8" x 1 5/8" Corner Clamp

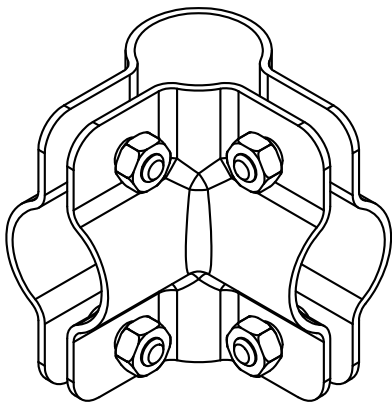

CL-90070043

1 5/8" 4-Way Clamp

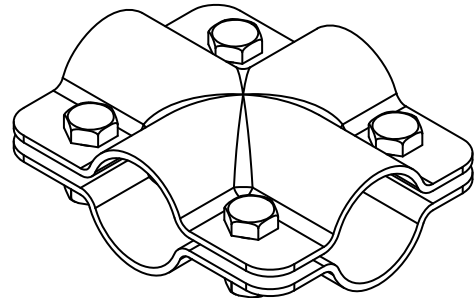

WEDGE OR T-BOLT (CONCRETE)

2100125-20
WIDE WEDGE BOLT (BOX OF 20)

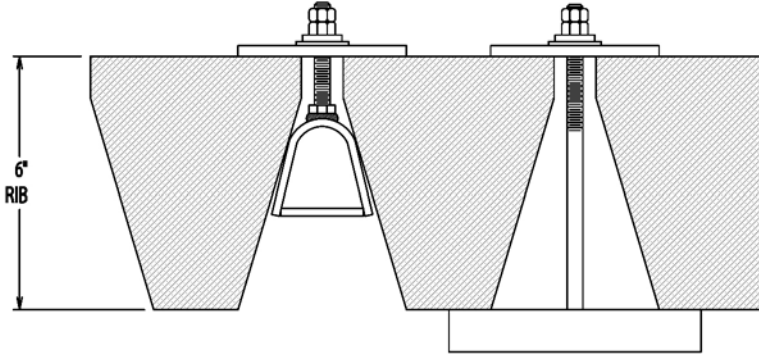

2100121-20
7 1/4" LG. T-BOLT (BOX OF 20)

2100225-20
NARROW WEDGE BOLT (BOX OF 20)

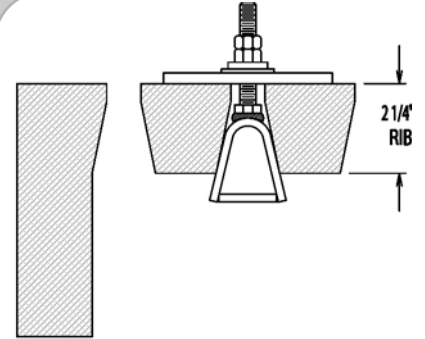

T-BOLTS

2099220
PKG OF 4 T-BOLTS (BLOCK & WASHER)

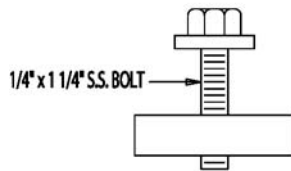

2100120-120
T-BOLT 2" LG. (BOX OF 20)

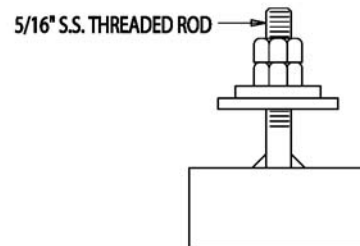

TOPLOCK J-BOLTS

2100135-20
J-BOLT 5 1/4" LG. (BOX OF 20)

