



HEAD OFFICE 20 ARTHUR STREET NORTH, ELMIRA, ONTARIO N3B 1Z9
 TEL: (519) 669-4025 FAX: (519) 669-1436

ORDER DESK e-mail: orders@walcoequipment.com
 TEL: (519) 669-1401 FAX (519) 669-3499

QUEBEC OFFICE 364 RTE.122 ST.GERMAIN DE GRANTHAM, QUÉBEC J0C 1K0
 TEL: (819) 395-5115 Fax (819) 395-2624
 e-mail: walcoqc@walcoequipment.com

SECTION



PAGE 1

HITCH ACCESSORIES

HITCH BALLS FORGED, CHROME PLATED HIGH QUALITY, LOAD RATED

ITEM #	VESC CLASS	MAX. LOAD	BALL SIZE	THREAD DIA.	STUD LENGTH
385401	I	2000	1-7/8	3/4	1-3/4
385402	II	3500	2	3/4	1-3/4
385403	III	5000	2	1	2-1/8
385404	IIII	7500	2-5/16	1-1/4	2-1/8



ANCHOR POINTS (FOR PICK UP TRUCKS)

ITEM #	TYPE	FINISH
381001	Eyebolt	Zinc Plated
381002	Decorative	Chrome Plated

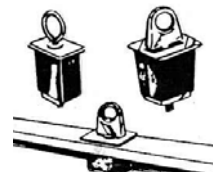

HITCH PINS (PLASTIC COATED)

ITEM #	DIA.	USABLE LENGTH
384501	1/2	3-5/8
384502	5/8	4
384503	5/8	5-1/2
384504	3/4	4
384505	3/4	6-1/2
384506	7/8	6-1/2
384507	1	7-1/2
384508	1-1/8	8-1/2
384509	1-1/4	8-1/2
384510	1-1/2	8-1/2

Made of high tensile steel.
 One piece forged pin w/
 extra large head.
 Welded, red plastic coated handle.



Baked black painted finish on pin.
 Includes pin.
 Heat treated to 28 - 35 rockwell.

HITCH PINS (DROP FORGED)

ITEM #	DIA.	USABLE LENGTH	LIST
384604	3/4	4	
384607	5/8	6	
384608	3/4	6-1/4	
384609	7/8	6-1/2	
384610	1	6-3/4	
384611	1-1/8	7	
384612	1-1/4	7	

Forged from high tensile steel.
 One piece, drop forged pin
 is painted and baked bright red.



Zinc plated spring wire handle.
 Includes hair pin.
 Heat treated to 28 - 35 rockwell

HITCH PINS (WITH CHAIN)

ITEM # /CLIP	DIA.	USABLE LENGTH	ITEM # /CHAIN
384701	1/2	4-1/4	384801
384702	5/8	4-1/4	384802
384703	5/8	6-1/4	384803
384704	3/4	4-1/4	384804
384705	3/4	6-1/4	
384706	7/8	4-1/4	384806
384707	7/8	6-1/4	384807
384708	1	4-1/4	
384709	1	6-1/4	

Forged from 1040 steel.
 Zinc plated, pin
 Spring wire handle.
 Includes Hair clip cotter pin.



HITCH PINS WITH LOCK HANDLE

ITEM #	PIN DIA.	COLLAR DIA.	USABLE LENGTH
387120	.50"	1"	4.25"
387121	.62"	1.13"	4.25"
387122	.75"	1.25"	4.25"
387123	.75"	1.25"	6.25"
387124	.87"	1.38"	6.25"
387125	1"	1.50"	6.25"

Made of 1040 Steel
 Zinc plated



HITCH PINS (BENT)

ITEM #	DIA.	LENGTH	PRICE
385001	1/2	3	
385002	5/8	3	
385003	3/4	3-1/2	

One piece, high carbon steel pin.
 Zinc plated. Includes clip.





HEAD OFFICE 20 ARTHUR STREET NORTH, ELMIRA, ONTARIO N3B 1Z9
 TEL: (519) 669-4025 FAX: (519) 669-1436

ORDER DESK e-mail: orders@walcoequipment.com
 TEL: (519) 669-1401 FAX (519) 669-3499

QUEBEC OFFICE 364 RTE.122 ST.GERMAIN DE GRANTHAM, QUÉBEC J0C 1K0
 TEL: (819) 395-5115 Fax (819) 395-2624
 e-mail: walcoqc@walcoequipment.com

SECTION



PAGE 2

LYNCH PINS

ITEM #	A		B		C	
	IN.	MM.	IN.	MM.	IN.	MM.
385501	3/16	4	1-1/8	28	13/8	35
385502	1/4	6	1-7/16	36.5	1-3/4	44.5
385503	5/16	8	1-7/16	36.5	1-3/4	44.5
385505	3/8				1-3/4	
385507	7/16	11	1-13/32	36	1-3/4	44.5
385508	7/16	11	1/17/16	36.5	2	51
WITH HEAVY DUTY RING						
385510	7/16	11	1-13/32	36	1-3/4	44.5

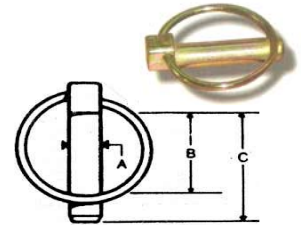

HAIR CLIP COTTER (MADE OF SPRING STEEL)

ITEM #	A		PIN SIZE		B	
	in.	mm	in.	mm	in.	mm
383501	5/64	2	1/4-7/16	6-11	1-5/8	42
383502	3/32	2.5	5/16-1/2	8-12	1-11/16	43
383503	1/8	3	3/8-11/16	10-18	2-1/2	64
383504	5/32	4	1/2-7/8	12-22	3	76
383505	11/64	4.5	3/8-11/16	10-18	4-1/8	105
383506	13/64	5	5/8-1-1/16	16-27	4	100
383507	1/4	6	3/4-1-1/4	19-32	4-1/2	110
383508	9/32	7	1-1-1/2	25-28	6	152

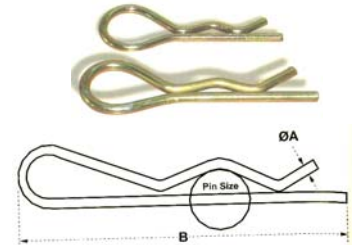

SAFETY PINS

ITEM #	LENGHT-A	LENGHT-B	WIDTH -C
387301	1-9/16"	1-5/16"	3/8"
387302	1-3/4"	1-1/16"	3/8"
387303	2-3/4"	1-11/16"	5/8"
387304	4-3/8"	2-13/16"	13/16"
387305	5-3/4"	3-3/4"	1-1/8"

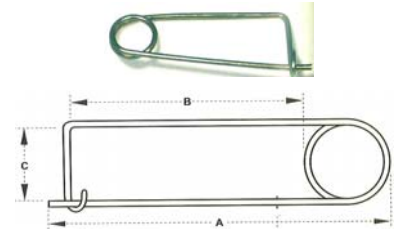

SNAPPER PINS

ITEM #	SIZE	SHAPE
387104	1/4 x 1-3/8	Round
387114	1/4 x 2-1/2	Round
387108	5/16 X 2-1/4	Round
387109	5/16 X 2-1/4	Square
387110	3/8 X2 -1/4	Round
387113	3/8 x 2-1/2	Square
387106	1/4 X 2-3/4	Round
387112	1/4 X 2-3/4	Square
387115	1/4 x 2-1/2	Square



LIFT ARM PINS

ITEM #	CAT.	TYPE	USABLE	PIN		THREAD	OVERALL
				DIA.	DIA.		
386001	0	Adj.	Adj.	5/8	5/8		4
386002	1	Adj.	Adj.	7/8	7/8		5-5/16
386003	1	Forged	1-3/4	7/8	7/8		5-1/2
386006	1 to 2	Adj.	Adj.	1-1/8	7/8		5-3/16
386007	1 to 2	Forged	1-3/4	1-1/8	7/8		5-1/4
386009	2 to 1	Forged	1-3/4	7/8	1-1/8		5-3/4
386010	1 & 2	Forged	2-1/16	7/8&1-1/8	1		8
386011	2	Adj.	Adj.	1-1/8	1-1/8		6-1/4
386012	2	Forged	1-3/4	1-1/8	1-1/8		6-1/4
386013	2 to 3	Forged	1-7/8	1-7/16	1-1/8		5-7/8
386014	3	Forged	2	1-7/16	1-3/8		5-7/8
386015	2	Clevis	4-7/16	1-1/8			6-1/2

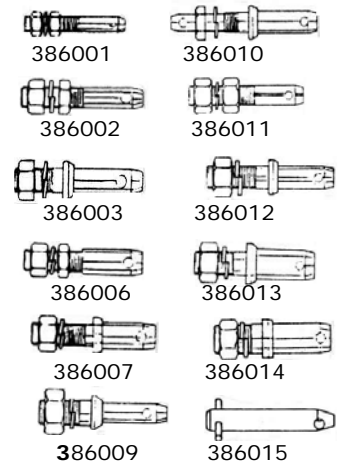



HEAD OFFICE 20 ARTHUR STREET NORTH, ELMIRA, ONTARIO N3B 1Z9
 TEL: (519) 669-4025 FAX: (519) 669-1436

ORDER DESK e-mail: orders@walcoequipment.com
 TEL: (519) 669-1401 FAX (519) 669-3499

QUEBEC OFFICE 364 RTE. 122 ST. GERMAIN DE GRANTHAM, QUÉBEC J0C 1K0
 TEL: (819) 395-5115 Fax (819) 395-2624
 e-mail: walcogc@walcoequipment.com

SECTION



PAGE 3

DRAWBAR (ONE PIECE)

ITEM #	L CAT.	LIFT ARM		HOLE DIA.	PIN DIA.	THICKNESS	WIDTH
		SPACING	# OF HOLES				
383001	1	20	7	3/4	7/8	1	2-1/2
383002	1	26	11	3/4	7/8	1	2-1/2
383003	2	26	11	3/4	1-1/8	1-1/4	3
383004	2	32	13	3/4	1-1/8	1-1/4	3



TOP LINKS

ITEM #	CAT	PIN TYPE	THREAD		ADJUSTMENT		
			HOLES	DIA.	BODY	Hole	Center
387601	0	Std	5/8	3/4	7-1/2	10-3/4	16-3/8
387602	1	Std	3/4	1-1/8	13	17-1/2	26
387603	1	Std	3/4	1-1/8	16	20-1/2	29
387604	1	Std	3/4	1-1/8	20	24-1/2	33
387605	1&2	Std	3/4&1	1-1/8	16	20-3/4	31
387606	1&2	Std	3/4&1	1-1/8	20	24-3/4	35
387608	2	Std	1	1-1/8	16	21	33
387609	2	Std	1	1-1/8	20	25	37
387612	3	HD	1-1/4	1-3/8	19	25-1/2	36-1/2



TOP LINK PINS

ITEM #	CAT.	DIA.	USABLE	OVERALL
387501	0	5/8	2-3/4	4-7/16
387502	1	3/4	2-3/4	4-1/2
387503	1	3/4	3-7/8	5-1/2
387504	1	3/4	4-3/4	6-3/8
387505	2	1	3-9/16	5-1/4
387506	2	1	4-5/16	6
387507	3	1-1/4	4-7/16	6-1/2



REPLACEMENT ENDS (TOP LINKS)

ITEM #	THREAD	CAT.	PIN		THREAD	
			HOLES	DIA.	DIA.	DIA.
387701	LH	1	3/4	1-1/8	1-1/8	1-1/8
387702	RH	1	3/4	1-1/8	1-1/8	1-1/8
387703	LH	2	1	1-1/8	1-1/8	1-1/8
387704	RH	2	1	1-1/8	1-1/8	1-1/8
387705	LH	2 HD	1	1-1/4	1-1/4	1-1/4
387706	RH	2 HD	1	1-1/4	1-1/4	1-1/4
387707	LH	3 HD	1-1/4	1-3/8	1-3/8	1-3/8
387708	RH	3 HD	1-1/4	1-3/8	1-3/8	1-3/8



387650 Hyd. Top Link Adapter Kit Cat. II

ITEM #	DESCRIPTION	H.P.	SPLINE	SPLINE	PTO	OVERALL
386801	Forged Increaser	70	1-1/8 x 6	1-3/8 x 6	1-1/8	3
386802	Sleeve Increaser Fits all except Ford	70	1-1/8 x 6	1-3/8 x 6	0	2-1/4
386803	Sleeve Increaser	70	1-1/8 x 6	1-3/8 x 6	0	1-7/8
386804	Forged Increaser	70	1-1/8 x 6	1-3/8 x 6	2-1/2	4-5/8
386805	Forged Reducer	70	1-3/8 x 6	1-3/8 x 6	2-3/4	5-3/8
386806	Forged Extender	70	1-3/8 x 6	1-3/8 x 6	3	5-3/8
386808	21 to 6 Splined OR 1000 to 540 RPM	70	1-3/8x21	1-3/8x6	4-1/8	6-3/8
386809	QR 6 Splined Extender	70	1-3/8 x 6	1-3/8 x 6	4-1/8	3-3/8
386810	QR 21 Splined Extender	70	1-3/8 x 21	1-3/8 x 21	4-1/8	5-7/8
386813	20 to 6 Splined H.D. Adaptor	150	1-3/4 x 20	1-3/8 x 6	5	7-7/8
386815	20 to 21 Splined H.D. Adaptor	150	1-3/4 x 20	1-3/8 x 21	5-1/2	7-7/8

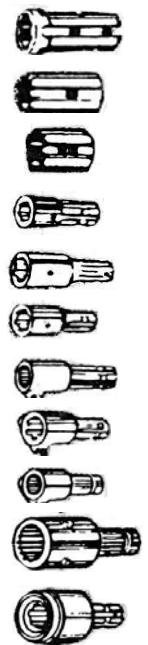



HEAD OFFICE 20 ARTHUR STREET NORTH, ELMIRA, ONTARIO N3B 1Z9
 TEL: (519) 669-4025 FAX: (519) 669-1436

ORDER DESK e-mail: orders@walcoequipment.com
 TEL: (519) 669-1401 FAX (519) 669-3499

QUEBEC OFFICE 364 RTE. 122 ST. GERMAIN DE GRANTHAM, QUÉBEC J0C 1K0
 TEL: (819) 395-5115 Fax (819) 395-2624
 e-mail: walcoqc@walcoequipment.com

SECTION



PAGE 4

BALL ENDS (LOWER LINK WELD-ON)

ITEM #	A		B		C		D		E		F	
	in.	mm	in.	mm	in.	mm	in.	mm	in.	mm	in.	mm
381806	2-3/4	70	7/8	22	2-3/8	60	5/8	16	1-3/8	35	2-5/8	66
381807	3-1/8	80	1	25	2-3/4	70	3/4	19	1-1/2	38	3-1/4	82
381808	3-1/8	80	1-1/8	28.5	2-3/4	70	3/4	19	1-1/2	38	3-1/4	82

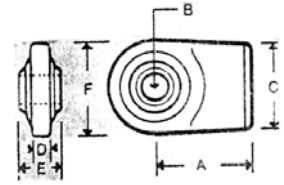

LIFT ARM SOCKETS (UNPLATED)

ITEM #	DESCRIPTION				
387907	H.D. Cat. 1 & 2	.7/8 & 1-1/8"	1-3/4"	1-3/8"	3-1/8"
387911	H.D. Cat. 2.	1-1/8"	1-3/4"	1-3/8"	3-1/8"
387913	Standard Cat. 3	1-7/16"	1-3/4"	1-11/32"	3-1/2"



TOP LINK SOCKETS (NOT PLATED)

ITEM #	DESCRIPTION
381501	Cat. 0
381502	Cat. I
381504	Cat. II
381506	Cat. III

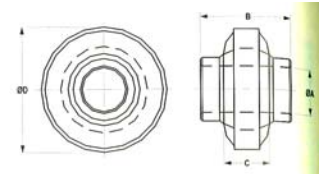

PIN KIT

ITEM #	DESCRIPTION	PIN DIA.	USABLE	OVERALL
386502	Pin w/2 Clips	1	2-3/4	3 1/2



STABILIZER PIN

ITEM #	PIN DIA.	THREAD DIA.	USABLE	OVERALL
387002	7/8"	5/8"	3/8"	2-5/8"
387020	7/8"	no thread	3/8"	1-1/2"



BUSHINGS (ZINC PLATED)

ITEM #	TYPE	CATEGORY	I.D.	O.D.	OVERALL
381701	Top Link	1-2	3/4	1	2
381702	Top Link	1-2	3/4	1	1-5/8
381703	Top link	2-3	1	1-1/4	2
381704	Lift Arm	1-2	7/8	1-1/8	1-3/4
381705	Lift Arm	1-2	7/8	1-1/8	1-3/8
381706	Lift Arm	2-3	1-1/8	1-7/16	1-3/4
381707	Lift Arm		1-1/8		2-3/4
381708	Lift Arm	2-3	1-1/8	1-7/16	3-1/4
381709	Lift Arm	2-3	1-1/8	1-7/16	2-1/2



HITCH BUSHING (ZINC PLATED)

ITEM #	CATEGORY	I.D.	O.D.
385301	2 to 3	1-1/8	1-7/16



RATCHET JACK & HYDRAULIC CYLINDER

ITEM #	DESCRIPTION	THREAD	CLEVIS	ADJ.
		DIA.	PIN DIA.	
386501	Ratchet Jack w/Pins & Handle	1-1/4	1	20 - 28



TRACTOR DRAWBAR GRAB HOOK

ITEM #	PIN DIAMETER	W.L.L. LBS.
387801	3/4	9500



CLEVIS

ITEM #	TYPE	PIN	BODY	W.L.L.
		SIZE	DIA.	LBS.
382501	Straight	1/2	5/8	7,000
382502	Twist	1/2	5/8	7,000
382503	Straight	5/8	3/4	14,000
382504	Twist	5/8	3/4	14,000
382505	Straight	3/4	7/8	18,000
382506	Twist	3/4	7/8	18,000
382507	Straight	7/8	15/16	22,000
382508	Twist	7/8	15/16	22,000
382509	Straight	1	1	25,000
382510	Twist	1	1	25,000

