

*Operator's Manual*

# 4500P

*Europe CE*

*Serial Number 4500P-AM01001 --*





500 Venture Drive  
Orrville Oh 44667  
www.ventrac.com

View all manuals



Visit [ventrac.com/manuals](http://ventrac.com/manuals) for the latest version of this operator's manual.

A downloadable parts manual is also available.

### To the Owner Contact Information and Product Identification

If you need to contact an authorized Ventrac dealer for information on servicing your product, always provide the product model and serial numbers.

*Please fill in the following information for future reference. See the picture(s) below to find the location of the identification numbers. Record them in the spaces provided.*

Date of Purchase: \_\_\_\_\_

Dealer: \_\_\_\_\_

Dealer Address: \_\_\_\_\_

Dealer Phone Number: \_\_\_\_\_

Dealer Fax Number: \_\_\_\_\_

Model # (A): \_\_\_\_\_

Serial # (B): \_\_\_\_\_

Affix Part/Serial Number label here.

Engine Serial # (C) \_\_\_\_\_

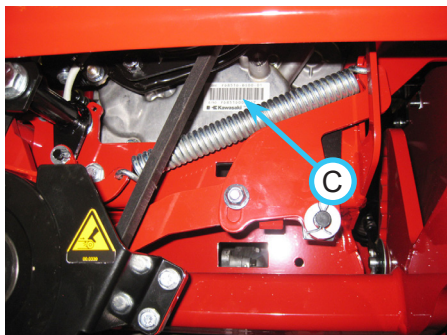

Venture Products Inc. reserves the right to make changes in design or specifications without obligation to make like changes on previously manufactured products.

# TABLE OF CONTENTS

<b>INTRODUCTION</b>	<b>PAGE 7</b>
Product Description.....	8
Why Do I Need an Operator’s Manual? .....	8
Using Your Manual .....	9
Manual Glossary .....	9
Safety Decals .....	10
<b>SAFETY</b>	<b>PAGE 13</b>
General Safety Procedures.....	14
Training Required.....	14
Requirements for Personal Protective Equipment (PPE).....	14
Operation Safety .....	14
Preventing Accidents.....	15
Keep Riders Off.....	15
Operating On Slopes.....	16
Roadway Safety .....	16
Truck Or Trailer Transport .....	16
Maintenance.....	17
Fuel Safety .....	17
Hydraulic Safety .....	18
Roll Over Protective Structure (ROPS).....	19
Operator Access System.....	19
Operator Safety Interlock System .....	20
<b>OPERATIONAL CONTROLS</b>	<b>PAGE 22</b>
Standard Operational Control Locations .....	22
Optional Operational Control Locations .....	23
Information Cluster Gauge (A) .....	24
Warning Cluster Gauge (B).....	24
Warning Alarm (C).....	24
Ignition Switch (D).....	24
Throttle Lever (E) .....	25
Headlight Switch (F).....	25
Power Take Off (PTO) Switch (G).....	25
Parking Brake (H).....	25
Neutral Assist Lever (I).....	25
Front Hitch Lever Lock (J).....	25
Front Hitch Latch Lever (K).....	25
Auxiliary Hydraulic Quick Couplers (L).....	25
PTO Belt Tensioner Rod (M) .....	26
High/Low Shift Lever (N) .....	26
Weight Transfer Traction Control Select Lever (O) .....	26
SDLA Control Lever (P & Q) .....	27
Steering Wheel (R).....	27
Hydraulic Cooler Fan Switch (S).....	27
Front Hitch Valve (T) .....	27
Seat Slide Lever (U).....	27
Fuel Shut-off Valve (V) .....	28
Circuit Breaker & Battery Disconnect (W).....	28

# TABLE OF CONTENTS

## OPERATIONAL CONTROLS (Continued)

Seat Prop Plate (X) .....	28
Seat Latch Strap (Y).....	28
Work Light Switch (AA) .....	28
Strobe Light Switch (BB).....	28
Slope Indicator Gauge (CC).....	28
Slope Warning Light (DD) .....	28
Directional Signal Switch (EE) .....	28
Hazard Flasher Switch (FF) .....	29
Horn Switch (GG).....	29
Foot Pedal (HH) .....	29
3 Point Hitch & Rear Auxiliary Control Handles (II, JJ, & KK) .....	29
Rear Auxiliary Quick Couplers (LL) .....	29
12 Volt Rear Switches & 4-Pin Socket (MM, NN, & OO).....	30
Back Up Alarm (PP) .....	30
12 Volt Front Switches & 4-Pin Socket (QQ, RR, & SS) .....	30
Dual Hydraulic Front Coupler Switch (TT) .....	30
Seat Slide Lever (UU) .....	30
Lumbar Support Knob (VV).....	30
Backrest Angle Lever (WW).....	30
Weight Adjustment Lever (XX).....	31
Optional Armrest Angle Knob (YY).....	31

## GENERAL OPERATION

**PAGE 32**

Daily Inspection.....	32
Starting The Engine .....	32
Forward And Reverse .....	33
Stopping The Power Unit .....	33
Shutting Off The Engine .....	33
Attaching .....	33
Detaching .....	34
Operating Attachments.....	34
Front Hitch.....	34
PTO Drive Belt & Pulley .....	34
Front Auxiliary Couplers .....	34
Weight Transfer .....	35
High/Low Range.....	35
Turning Radius .....	35
Roll-Over Protection System.....	36
3 Point Hitch (Optional Accessory).....	36
12 Volt 4-Pin Auxiliary Outlets (Optional Accessory).....	36
Directional/Hazard Flasher Operation (Optional Accessory).....	37
Suspension Seat Weight Adjustment (Optional 70.4111 Suspension Seat Kit) .....	37
Operating On Slopes.....	37
70.4140 Slope Gauge Settings & Operation .....	38
70.4140 Slope Gauge Calibration .....	40
Operation in Water, Mud, Snow, or Ice .....	41
Towing Or Pushing The Power Unit .....	41

# TABLE OF CONTENTS

<b>SERVICE</b>	<b>PAGE 42</b>
Service And General Maintenance.....	42
Cleaning And Appearance Care.....	42
Service Access Points.....	43
Lubrication Locations.....	43
Checking Hydraulic Oil Level.....	44
Checking Rear Transaxle Oil.....	45
Changing Hydraulic Oil Filters.....	45
Changing Hydraulic Oil.....	46
Changing Rear Transaxle Differential Oil.....	47
Servicing Closed Loop Hydrostatic Drive Circuit.....	47
Servicing Hydraulic Oil Cooler.....	47
Checking Engine RPM.....	47
Checking Engine Oil Level.....	48
Changing Engine Oil And Filter.....	48
Changing Air Filter Elements.....	49
Filling The Fuel Tank.....	50
Changing The In-line Fuel Filter.....	50
Priming The Fuel System.....	50
Cleaning Engine Compartment & Engine.....	50
Servicing The Cooling System.....	51
Checking The Cooling System.....	51
Cleaning The Radiator And Screen.....	52
Draining The Cooling System.....	52
Flushing The Cooling System.....	52
Servicing The Battery.....	53
Removing The Battery.....	53
Installing The Battery.....	53
Cleaning The Battery And Terminals.....	54
Charging The Battery.....	54
Jump Starting Procedure.....	54
TCM (Tractor Control Module) Explanation.....	55
Replacing Fuses (Power Relay Module).....	55
Replacing Fuses (Front Fuse Panel).....	55
Replacing Fuses (Rear Fuse Panel).....	56
Replacing Fuses (Engine).....	56
Switching Speedometer (MPH or Km/H).....	56
Replacing Light Bulbs (Headlights & Halogen Work Lights).....	57
Replacing The Work Lights (LED).....	57
Replacing The Taillights.....	57
Replacing The Turn Signal Lights.....	57
Replacing The Strobe Light Bulb.....	57
Replacing The Strobe Light.....	58
Changing the Strobe Light Flasher Mode.....	58
PTO Belt Inspection.....	58
PTO Belt Tension Adjustment.....	59
PTO Belt Replacement.....	59
Clutch Air Gap Inspection & Adjustment.....	59
Wheel Removal & Installation.....	60

# TABLE OF CONTENTS

---

## **SERVICE (Continued)**

Outer Dual Wheel Removal & Installation.....	60
Tire Pressure.....	61
ROPS And Seat Belt Inspection.....	61
Parking Brake Inspection & Adjustment.....	62
Neutral Adjustment.....	62
Neutral Switch Adjustment.....	63
Storage.....	64
Maintenance Schedule.....	66
Maintenance Checklist.....	67
Ventrac Maintenance Log.....	68

## **TROUBLESHOOTING**

**PAGE 71**

Wiring Diagram Reference Key.....	71
Wiring Diagram - Rear Harness.....	72
Wiring Diagram - Front Harness.....	73
Wiring Diagram - Engine Harness.....	74
Wiring Diagram - Optional 30.0219 4-Pin Female Socket & 30.0218 4-Pin Male Plug.....	75
Electrical Troubleshooting Using The Tractor Control Module (TCM).....	76
Electrical Troubleshooting Guide.....	78
Engine.....	79
Electrical.....	80
Hydraulic.....	81
Power Unit.....	81

## **SPECIFICATIONS**

**PAGE 82**

Engine.....	82
Electrical.....	82
Power Train.....	82
Controls & Instrument Panel.....	82
Other Features.....	82
Dimensions.....	83
Fluid Capacities & Specifications.....	83
Amperage Draw Chart.....	84
Belt Chart.....	85
Noise Emissions.....	85
Vibration Levels.....	86
EC Declaration of Conformity.....	86

## **WARRANTY**

**PAGE 87**

# INTRODUCTION



Venture Products Inc. is pleased to provide you with your new Ventrac power unit! We hope that Ventrac equipment will provide you with a ONE Tractor Solution.

Listed below are just some of the items that can provide you *versatility* as you use your 4500. Please visit our web site, or contact your authorized Ventrac dealer for a complete list of items available for your new power unit.

Accessories	Item Description	Part Number	Accessories	Item Description	Part Number
	Three Point Hitch	70.4100		Raised Foot Platform Kit	70.4108
	Dual Wheels (All Terrain Tires)	70.4067		12 Volt Front Kit	70.4104
	Dual Wheels (Turf Tires)	70.4068		12 Volt Rear Kit	70.4105
	Dual Wheels (Bar Tires)	70.4069		Horn Kit	70.4120
	Wheel Extensions	70.4098		ES220 Spreader	39.55500
	Weather Cab	70.2014		Rear Counter Weight Bar	70.4144
	Foot Control Kit	70.4107		Trailer Mover Hitch	70.2016
	Suspension Seat	70.4154		Dual Hydraulic Auxiliary	70.4109
	Backup Alarm Kit	70.4101		Three-N-One Hitch (for 3-point hitch)	39.56114
	LED Work Light Kit	70.4133		Mid Weight Bar Kit	70.4137
	Strobe Light Kit	70.4155		SA250 Drop Spreader	70.2013
	Directional / Hazard Signal Kit	70.4156			
Slope Indicator Kit	70.4140				

Attachments	Item Description	Part Number	Attachments	Item Description	Part Number
	Aerator with Open Spoon Tine	39.55490		Power Bucket - 30"	39.55213
	Aerator with Slitter/Slicer Tine	39.55492		Power Bucket - 48"	39.55214
	Aerator with Coring Tine	39.55494		Rear Discharge Mower - 72"	39.55117
	AeraVator (seeder kit available)	39.55460		Reel Mower - 74"	39.55130
	Ballpark Renovator (Front)	39.55280		Snow Blower	39.55427
	Ballpark Groomer (Rear)	39.55285		Sod Cutter	39.55520
	Blade - 48"	39.55251		Stump Grinder	39.55300
	Blade - 60"	39.55252		Terra Rake - 52"	39.55431
	Blade - 72"	39.55253		Tiller	39.55220
	Blower	39.55440		Tough Cut Mower - 68"	39.55104
	Boom Mower	39.55170		Trencher	39.55455
	Broom	39.55400		Turbine Blower	39.55340
	Contour Mower - 84"	39.55161		V-Blade	39.55271
	Edger	39.55332			
	Finish Mower - 60"	39.55116			
	Power Rake	39.55435			

# INTRODUCTION

---

## Product Description

The Ventrac 4500 tractor combines All Wheel Drive and an articulating chassis with a low center of gravity to provide superior traction, braking, stability, and security on tough terrain and slopes without disturbing turf when turning. The attachment is placed out front in a natural view, offering greater precision, as well as maximum protection for the operator.

Ventrac's patented SDLA control, located next to the operator, allows for easy control of Speed, Direction, Lift, and Auxiliary functions with one hand.

Standard features include:

- a fold down roll bar.
- a computer controlled onboard diagnostic system for the electrical circuits.
- a wiring harness that is pre-wired for optional accessories.
- an electronic instrument panel that includes a tachometer, speedometer, fuel gauge, hour meter, and temperature gauge.
- a six function warning gauge and alarm that includes engine coolant temp, hydraulic oil temp, engine oil temp, low voltage, low engine oil pressure, and parking brake indicator.
- a complete electrical system circuit breaker and battery disconnect.
- an automotive pull style park brake.
- a hydraulic oil cooler with a thermostatically controlled, reversible fan.

## Why Do I Need an Operator's Manual?

This manual has been created to help you gain the important knowledge of what is needed to safely operate, maintain, and service your machine. It is divided into sections for convenient reference of the appropriate section.

You must read and understand the operator's manual for each piece of Ventrac equipment you own. Reading the operator's manual will help you become familiar with each specific piece of equipment. Understanding the operator's manual will help you, as well as others, avoid personal injury and/or damage to the equipment. Keep this manual with the machine at all times. The manual should remain with the machine even if it is sold. If this manual becomes damaged or unreadable, it should be replaced immediately. Contact your local Ventrac dealer for a replacement.

When using a Ventrac attachment, be sure to read and follow the safety and operating instructions of both the power unit and the attachment being used to ensure the safest operation possible.

The information in this manual provides the operator with the safest procedures to operate the machine while getting the maximum use out of the unit. Failure to follow the safety precautions listed in this manual may result in personal injury and/or damage to the equipment.



# INTRODUCTION

---

## Using Your Manual

Throughout this manual, you will encounter special messages and symbols that identify potential safety concerns to help you as well as others avoid personal injury or damage to the equipment.

### SYMBOL DEFINITIONS



#### **ATTENTION**

This symbol identifies potential health and safety hazards. It marks safety precautions. Your safety and the safety of others is involved.

There are three signal words that describe the level of safety concern: Danger, Warning, and Caution. Safety should always be the #1 priority when working on or operating equipment. Accidents are more likely to occur when proper operating procedures are not followed or inexperienced operators are involved.

**Note:** Right-Hand and Left-Hand orientations may be referred to at different places throughout this manual. Right-Hand and Left-Hand is determined as if sitting on the power unit seat facing forward.

### SIGNAL WORD DEFINITIONS

#### **⚠ DANGER**

Indicates an imminently hazardous situation which, if not avoided, will result in death or serious injury. This signal word is limited to the most extreme cases.

#### **⚠ WARNING**

Indicates a potentially hazardous situation which, if not avoided, could result in death or serious injury.

#### **⚠ CAUTION**

Indicates a potentially hazardous situation which, if not avoided, may result in minor or moderate injury and/or property damage. It may also be used to alert against unsafe practices.

## Manual Glossary

- Power Unit** A Ventrac tractor or other Ventrac engine powered device that may be operated by itself or with an attachment or accessory.
- Attachment** A piece of Ventrac equipment that requires a Power Unit for operation.
- Accessory** A device that attaches to a Power Unit or Attachment to extend its capabilities.
- Machine** Describes any "Attachment" or "Accessory" that is used in conjunction with a power unit.

# SAFETY

## Safety Decals

The following safety decals must be maintained on your Ventrac 4500 power unit.

Keep all safety decals legible. Remove all grease, dirt, and debris from safety decals and instructional labels. If any decals are faded, illegible, or missing, contact your dealer promptly for replacements.

When new components are installed, be sure that current safety decals are affixed to the replacement components.

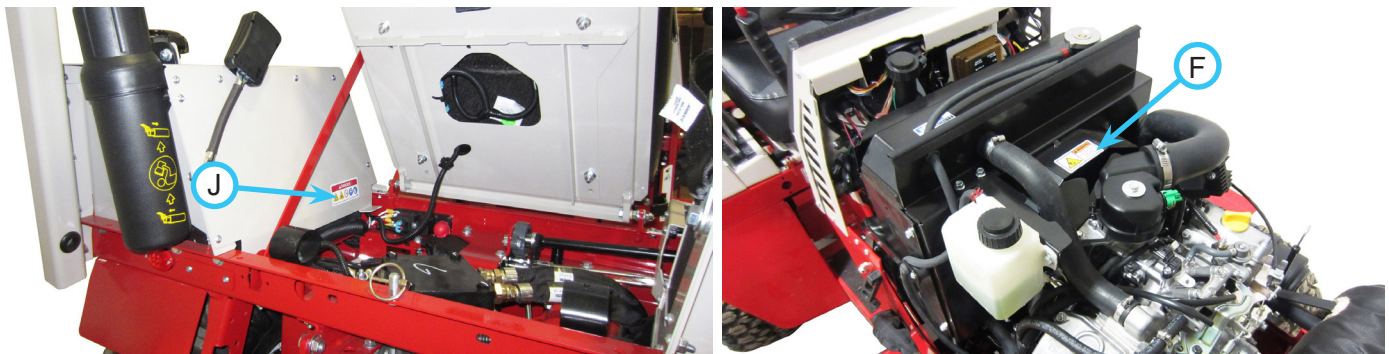

Directional/Hazard Light Kit



# SAFETY

**A**



Venture Products, Inc  
328 E Water Street  
Orrville, OH 44667

This ROPS was manufactured by Venture Products Inc. and was tested in accordance with SAE J1194 & OSHA 1928.51 (ROPS) and ISO 6683 (Seat Belt Anchorage).

Vehicle Model: Ventrac 4500  
Max GVW: 4000 lbs (1818 kg)

ROPS certification applies only when rollbar is locked in upright position.

Alterations to this structure are not permitted.

If any part of this ROPS experiences structural damage, the entire ROPS must be replaced.

This decal must be kept intact at all times.



00.0331

1. WARNING: Rollover!
2. Keep the roll bar in the raised and locked position and the seat belt securely fastened during operation.

**B**



00.0332

1. DANGER: Explosion/Fire Hazard
2. Keep away from fire, sparks, and pilot lights when refueling or storing machine and fuel.
3. Smoking is prohibited.

**C**

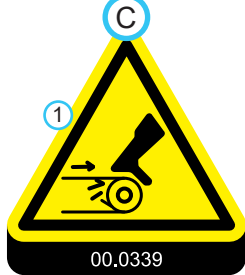

00.0339

1. Cutting/entanglement hazard - Stay away from moving parts.

**D**



00.0336

1. Operators must receive training prior to operating the machine.
2. Do not operate with shields or guards removed.
3. Wear personal protective gear, such as safety glasses, closed toe shoes or boots, and ear protection.
4. Do not operate while under the influence of drugs or alcohol.
5. Do not carry passengers. Stop the machine if someone enters the area.
6. WARNING: Stay away from the edge of drop-offs, ditches, and embankments. The machine could roll over if a wheel drops over the edge or if the edge caves in.
7. WARNING: Read slope operation instructions. Use low range when operating on slopes. Keep the roll bar in the raised and locked position and the seat belt securely fastened.
8. Only lower the roll bar if there is low overhead clearance. DO NOT wear a seat belt when operating with the roll bar in the lowered position. As soon as there is clearance, raise the roll bar to the upright position and lock it in place. ALWAYS wear a seat belt when operating with the roll bar in the raised position.
9. WARNING: Hydraulic fluid is under high pressure and can penetrate skin, causing injury. Keep hands, face, and body away from pinholes or nozzles that eject hydraulic fluid under high pressure.
10. When towing or pushing the power unit, the transaxles must be disengaged by moving the high/low range shift handle to the neutral position or damage to the hydraulic system will result.

# SAFETY

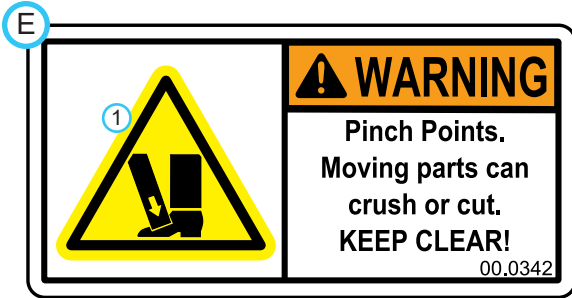

1. Cutting/crushing hazard - Stay away from moving parts.



1. Cutting/dismemberment/entanglement hazard - Stay away from moving parts.

**WARNING**

1. >20° Single Tires  
2. >25° Wheel Extensions  
3. >30° Dual Wheels

Operation on slopes increases the possibility for loss-of-control and tip over accidents  
Failure to operate responsibly may result in machine damage, personal injury, or death  
Use low range when operating on slopes greater than 15°  
Never shift between high and low range on a slope  
Reduce speed on rough ground or when turning  
Tire over-inflation may result in damage to the tractor and/or the operator  
Avoid operating in conditions where the outer tire (C) carries full weight  
Avoid running wheels into solid objects

Model	Slope Rating - Maximum Angle of Operation		
	Single Tires	Wheel Extensions	Dual Wheels
4500	20°	25°	30°
4500Z with Propane	15°	20°	25°

Tire Type	Tire Pressure		
	Single Wheel (A)	Inner Tire (B)	Outer Tire (C)
All Terrain	8-16psi (55-110kPa)	8-10psi (55-69kPa)	6-8psi (41-55kPa)
Bar	8-16psi (55-110kPa)	8-10psi (55-69kPa)	6-8psi (41-55kPa)
Turf	15-20psi (103-138kPa)	15-17 psi (103-117kPa)	10-12psi (69-83kPa)

Torque Specifications  
Wheel Lug Nut: 55 ft-lbs (75 Nm)      Dual Hub Draw Bolt: 120 ft-lbs (163 Nm)

1. WARNING: 20° maximum rating when equipped with single wheels.
2. WARNING: 25° maximum slope rating when equipped with 3" wheel extensions.
3. WARNING: 30° maximum slope rating when equipped with dual wheels.

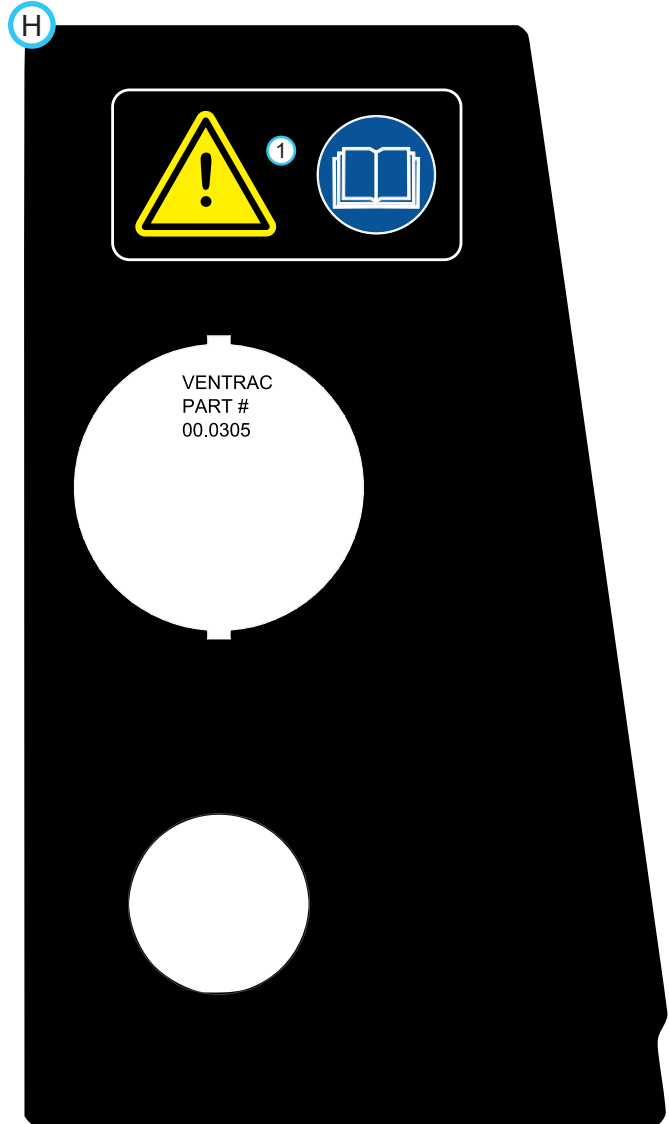

1. WARNING: Read operator's manual

# SAFETY



1. Danger: Battery acid is caustic and can cause chemical burns. Keep bystanders away from the battery.
2. Explosion hazard - batteries produce flammable and explosive gases.
3. Do not expose batteries to arcs, sparks, or open flames. Do not use smoking materials near batteries.
4. Wear eye protection, such as goggles or a face shield, when checking or servicing batteries.
5. Wear appropriate protective gear, such as rubber gloves and an apron, when checking or servicing batteries.

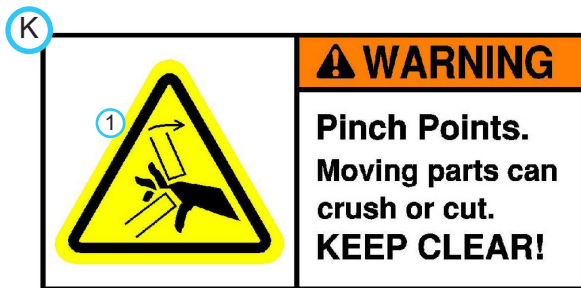

1. Cutting/crushing hazard - Stay away from moving parts.

Decal	Description	Part Number	Quantity
A	ROPS Certification	00.0331	1
B	Danger, Gasoline Only	00.0332	1
C	Moving Parts	00.0339	1
D	4500 Safety	00.0336	1
E	Warning, Pinch Point	00.0342	2
F	Warning, Fan	00.0341	1
G	Warning, 4500 Slope	00.0347	1
H	Right Dash	00.0305	1
J	Danger, Battery	00.0345	1
K	Warning, Pinch Point (directional/hazard light kit)	00.0218	2

# SAFETY



## General Safety Procedures for Ventrac Power Units, Attachments, & Accessories



### Training Required

- The owner of this machine is solely responsible for properly training the operators.
- The owner/operator is solely responsible for the operation of this machine and prevention of accidents or injuries occurring to him/herself, other people, or property.
- Do not allow operation or service by children or untrained personnel. Local regulations may restrict the age of the operator.
- Before operating this machine, read the operator's manual and understand its contents.
- If the operator of the machine cannot understand this manual, then it is the responsibility of this machine's owner to fully explain the material within this manual to the operator.
- Learn and understand the use of all controls.
- Know how to stop the power unit and all attachments quickly in the event of an emergency.



### Requirements for Personal Protective Equipment (PPE)

The owner is responsible for ensuring that all operators use the proper PPE while operating the machine. Whenever you use the machine, use the following PPE:



- Certified eye protection and hearing protection.
- Closed toe, slip resistant footwear.
- Long pants.
- A dust mask for dusty conditions.

### Operation Safety

- Inspect machine before operation. Repair or replace any damaged, worn, or missing parts. Be sure guards and shields are in proper working condition and are secured in place. Make all necessary adjustments before operating machine.
- Some pictures in this manual may show shields or covers opened or removed in order to clearly illustrate any instructions. Under no circumstance should the machine be operated without these devices in place.
- Alterations or modifications to this machine can reduce safety and could cause damage to the machine. Do not alter safety devices or operate with shields or covers removed.
- Before each use, verify that all controls function properly and inspect all safety devices. Do not operate if controls or safety devices are not in proper working condition.
- Check parking brake function before operating. Repair or adjust parking brake if necessary.
- Observe and follow all safety decals.
- All controls are to be operated from the operator's station only.
- Always wear a seat belt if the machine has a roll cage/bar installed and in upright position.
- Ensure the attachment or accessory is locked or fastened securely to the power unit before operating.
- Ensure that all bystanders are clear of the power unit and attachment before operating. Stop machine if someone enters your work area.
- Always be alert to what is happening around you, but do not lose focus on the task you are performing. Always look in the direction the machine is moving.
- Look behind and down before backing up to be sure of a clear path.
- If you hit an object, stop and inspect the machine. Make all necessary repairs before operating machine again.
- Stop operation immediately at any sign of equipment failure. An unusual noise can be a warning of equipment failure or a sign that maintenance is required. Make all necessary repairs before operating machine again.
- If equipped with a high/low range feature, never shift between high and low range while on a slope. Always move the machine to level ground and engage the parking brake before shifting range.

# SAFETY



## General Safety Procedures for Ventrac Power Units, Attachments, & Accessories



### Operation Safety (continued)

- Do not leave machine unattended while it is running.
- Always park the machine on level ground.
- Always shut off engine when connecting attachment drive belt to the power unit.
- Never leave the operator's station without lowering the attachment to the ground, setting the parking brake, shutting off the engine, and removing the ignition key. Make sure all moving parts have come to a complete stop before dismounting.
- Never leave equipment unattended without lowering the attachment to the ground, setting the parking brake, shutting off the engine, and removing the ignition key.
- Only operate in well-lit conditions.
- Do not operate when there is a risk of lightning.
- Never direct the discharge of any attachment in the direction of people, buildings, animals, vehicles, or other objects of value.
- Never discharge material against a wall or obstruction. Material may ricochet back towards the operator.
- Use extra caution when approaching blind corners, shrubs, trees, or other objects that may obscure vision.
- Do not run the engine in a building without adequate ventilation.
- Do not touch the engine or the muffler while the engine is running or immediately after stopping the engine. These areas may be hot enough to cause a burn.
- Do not change the engine governor settings or over-speed the engine. Operating engine at excessive speed may increase the hazard of personal injury.
- To reduce the hazard of fire, keep the battery compartment, engine, and muffler areas free of grass, leaves, excessive grease, and other flammable materials.
- Secure long hair and loose clothing. Do not wear jewelry.

### Preventing Accidents



- Clear working area of objects that might be hit or thrown from machine.
- Keep people and pets out of working area.
- Know the work area well before operation. Do not operate where traction or stability is questionable.
- Reduce speed when you are operating over rough ground.
- Equipment can cause serious injury and/or death when improperly used. Before operating, know and understand the operation and safety of the power unit and the attachment being used.
- Do not operate machine if you are not in good physical and mental health, if you will be distracted by personal devices, or are under the influence of any substance which might impair decision, dexterity, or judgment.
- Children are attracted to machine activity. Be aware of children and do not allow them in the working area. Turn off the machine if a child enters the work area.



### Keep Riders Off

- Only allow the operator on the power unit. Keep riders off.
- Never allow riders on any attachment or accessory.

# SAFETY



## General Safety Procedures for Ventrac Power Units, Attachments, & Accessories



### Operating On Slopes

- Slopes can cause loss-of-control and tip-over accidents, which can result in severe injury or death. Be familiar with the emergency parking brake, along with the power unit controls and their functions.
- If power unit is equipped with a fold down roll bar, it must be locked in the upright position when operating on any slope.
- Use low range (if equipped) when operating on slopes greater than 15 degrees.
- Do not stop or start suddenly when operating on slopes.
- Never shift between high and low range while on a slope. Always move the power unit to level ground and engage the parking brake before shifting range or placing the power unit in neutral.
- Variables such as wet surface and loose ground will reduce the degree of safety. Do not drive where machine could lose traction or tip over.
- Keep alert for hidden hazards in the terrain.
- Stay away from drop-offs, ditches, and embankments.
- Sharp turns should be avoided when operating on slopes.
- Pulling loads on hills decreases safety. It is the responsibility of the owner/operator to determine loads that can safely be controlled on slopes.
- Transport machine with attachment lowered or close to the ground to improve stability.
- While operating on slopes, drive in an up and down direction when possible. If turning is necessary while driving across slopes, reduce speed and turn slowly in the downhill direction.
- Ensure a sufficient supply of fuel for continuous operation. A minimum of one-half tank of fuel is recommended.

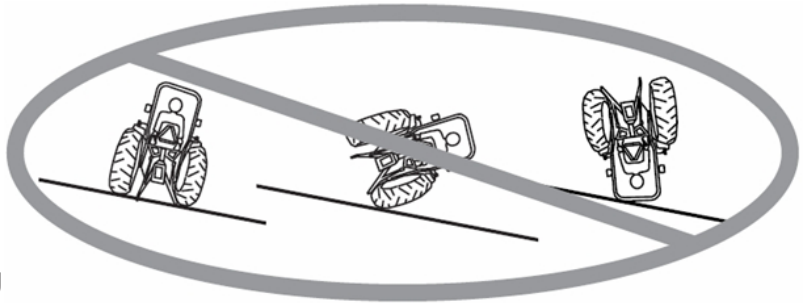

### Roadway Safety

- Operate with safety lights when operating on or near roadways.
- Obey all state and local laws concerning operation on roadways.
- Slow down and be careful of traffic when operating near or crossing roadways. Stop before crossing roads or sidewalks. Use care when approaching areas or objects that may obscure vision.
- If there is doubt of safety conditions, discontinue machine operation until a time when operation can be performed safely.
- When operating near or on roadways, have a Slow Moving Vehicle Emblem clearly displayed.

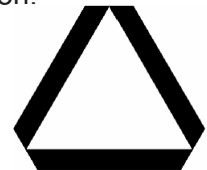

### Truck Or Trailer Transport

- Use care when loading or unloading machine into a truck or trailer.
- Use full width ramps for loading machine into a truck or trailer.
- The parking brake is not sufficient to lock the machine during transport. Always secure the power unit and/or attachment to the transporting vehicle securely using straps, chains, cable, or ropes. Both front and rear straps should be directed down and outward from the machine.
- Shut off fuel supply to power unit during transport on truck or trailer.
- If equipped, turn the battery disconnect switch to the Off position to shut off electrical power.



# SAFETY



## General Safety Procedures for Ventrac Power Units, Attachments, & Accessories



### Maintenance

- Keep all safety decals legible. Remove all grease, dirt, and debris from safety decals and instructional labels.
- If any decals are faded, illegible, or missing, contact your dealer promptly for replacements.
- When new components are installed, be sure that current safety decals are affixed to the replacement components.
- If any component requires replacement, use only original Ventrac replacement parts.
- Always turn the battery disconnect to the Off position or disconnect the battery before performing any repairs. Disconnect the negative terminal first and the positive terminal last. Reconnect the positive terminal first and the negative terminal last.
- Keep all bolts, nuts, screws, and other fasteners properly tightened.
- Always lower the attachment to the ground, engage parking brake, shut off engine, and remove the ignition key. Make sure all moving parts have come to a complete stop before cleaning, inspection, adjusting or repairing.
- If the power unit, attachment, or accessory requires repairs or adjustments not instructed in the operator's manual, the power unit, attachment, or accessory must be taken to an authorized Ventrac dealer for service.
- Never perform maintenance on the power unit and/or attachment if someone is in the operator's station.
- Always use protective glasses when handling the battery.
- Check all fuel lines for tightness and wear on a regular basis. Tighten or repair them as needed.
- To reduce the hazard of fire, keep the battery compartment, engine, and muffler areas free of grass, leaves, and excessive grease.
- Do not touch the engine, the muffler, or other exhaust components while the engine is running or immediately after stopping the engine. These areas may be hot enough to cause a burn.
- Allow the engine to cool before storing and do not store near an open flame.
- Do not change the engine governor settings or over-speed the engine. Operating engine at excessive speed may increase the hazard of personal injury.
- Springs may contain stored energy. Use caution when disengaging or removing springs and/or spring loaded components.
- An obstruction or blockage in a drive system or moving/rotating parts may cause a buildup of stored energy. When the obstruction or blockage is removed, the drive system or moving/rotating parts may move suddenly. Do not attempt to remove an obstruction or blockage with your hands. Keep hands, feet, and clothing away from all power-driven parts.

### Fuel Safety



- To avoid personal injury or property damage, use extreme care in handling gasoline. Gasoline is extremely flammable and the vapors are explosive.
- Do not refuel machine while smoking or at a location near flames or sparks.
- Always refuel the machine outdoors.
- Do not store machine or fuel container indoors where fumes or fuel can reach an open flame, spark, or pilot light.
- Only store fuel in an approved container. Keep out of reach of children.
- Never fill containers inside a vehicle or on a truck or trailer bed with a plastic liner. Always place containers on the ground away from your vehicle before filling.
- Remove machine from the truck or trailer and refuel it on the ground. If this is not possible, refuel the machine using a portable container, rather than from a fuel dispenser nozzle.
- Never remove fuel cap or add fuel with the engine running. Allow engine to cool before refueling.
- Never remove fuel cap while on a slope. Only remove when parked on a level surface.
- Replace all fuel tank and container caps securely.
- Do not overfill fuel tank. Only fill to bottom of fuel neck, do not fill fuel neck full. Overfilling of fuel tank could

# SAFETY



## General Safety Procedures for Ventrac Power Units, Attachments, & Accessories



### Fuel Safety (continued)

result in engine flooding, fuel leakage from the tank, and/or damage to the emissions control system.

- If fuel is spilled, do not attempt to start the engine. Move the power unit away from the fuel spill and avoid creating any source of ignition until fuel vapors have dissipated.
- If the fuel tank must be drained, it should be drained outdoors into an approved container.
- Check all fuel lines for tightness and wear on a regular basis. Tighten or repair them as needed.
- The fuel system is equipped with a shut-off valve. Shut off the fuel when transporting the machine to and from the job, when parking the machine indoors, or when servicing the fuel system.

### Hydraulic Safety

- Make sure all hydraulic connections are tight and all hydraulic hoses and tubes are in good condition. Repair any leaks and replace any damaged or deteriorated hoses or tubes before starting the machine.
- Hydraulic leaks can occur under high pressure. Hydraulic leaks require special care and attention.
- Use a piece of cardboard and a magnifying glass to locate suspected hydraulic leaks.



- Keep body and hands away from pinhole leaks or nozzles that eject high pressure hydraulic fluid. Hydraulic fluid escaping under high pressure can penetrate the skin causing serious injury, leading to severe complications and/or secondary infections if left untreated. If hydraulic fluid is injected into the skin, seek immediate medical attention no matter how minor the injury appears.

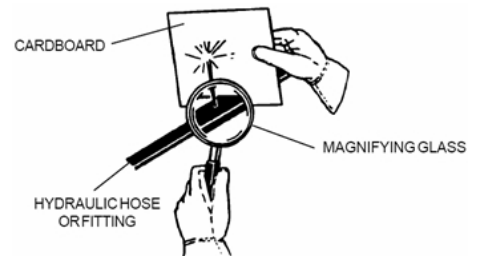

- Hydraulic system may contain stored energy. Before performing maintenance or repairs on the hydraulic system, remove attachments, engage parking brake, disengage weight transfer system (if equipped), shut off engine, and remove ignition key. To relieve pressure on the auxiliary hydraulic system, shut off the power unit engine and move the hydraulic control lever left and right before disconnecting the auxiliary hydraulic quick couplers.

# SAFETY



## 4500 Safety Procedures



- Power unit hydraulic system may contain stored energy. Before performing maintenance or repairs on the auxiliary hydraulic circuit, remove attachments, engage the park brake, disengage weight transfer system (if equipped), shut off engine, and remove the ignition key.
- Weight transfer spring may contain stored energy. Always disengage the weight transfer system (if equipped) before performing maintenance or repairs on the weight transfer system, the front hitch, or the lift hydraulics.

### Roll Over Protective Structure (ROPS)

#### **WARNING**

Keep the ROPS locked in the upright position and the seat belt securely fastened during operation. Failure to do so could result in serious injury or loss of life.

#### **WARNING**

Alterations or modifications to this machine and/or the ROPS structure can reduce safety and could cause damage to the machine. Do not alter the ROPS. Do not alter any other safety devices.

Your power unit is equipped with a Roll-Over Protective Structure (ROPS). This ROPS was tested and certified in accordance with the following standards.

**ROPS:** SAE J1194 and OSHA 1928.51 = maximum GVW of 4,000 pounds (1,818 kg).

ISO 21299 = maximum GVW of 2,930 pounds (1,329 kg).

**Seat Belt Anchorage:** ISO 3776-2, ISO 3776-3, ISO 6683, & SAE J386.

- ROPS certification applies only when the roll bar is locked in the upright position. Be aware there is no rollover protection when a folding ROPS is in the down position.
- DO NOT remove the ROPS. Alterations to the ROPS structure are not permitted.
- Lower the roll bar only when absolutely necessary and raise the roll bar to the upright position as soon as clearance allows. Never lower a folding ROPS in areas where there are slopes, drop offs, or water.
- Check carefully for overhead clearances (i.e. branches, doorways, electrical wires) before driving under any objects and do not contact them.
- Always wear the seat belt when the roll bar is locked in the upright position. Be certain the seat belt can be released quickly in the event of an emergency.
- Do not wear a seat belt when the roll bar has been lowered to the down position.
- If any part of this ROPS experiences structural damage, the entire ROPS must be replaced.
- Inspect the seat belt for wear or damage before use. Failure to inspect or maintain the seat belt can cause injury or loss of life.

### Operator Access System

- The operator access system is on the left side of the power unit. Mount and dismount the 4500 only on the left side of the power unit.

# SAFETY



## 4500 Safety Procedures



### Operator Safety Interlock System

The 4500 power unit is equipped with a safety interlock system. This system:

- Prevents the engine from starting unless the parking brake is engaged and SDLA control is in neutral.
- Prevents the PTO from starting if the operator is not in the seat.
- Prevents the power unit from driving if the parking brake is engaged.\*
- Shuts off the PTO if the operator leaves the seat^.
- Shuts off the engine (and fuel pump) if the operator leaves the seat without engaging the parking brake.
- Shuts off the engine if the forward / reverse controls (SDLA lever or foot pedal) are moved from neutral while the parking brake is engaged.

\*The parking brake must be completely disengaged before moving the SDLA lever forward or backward or the power unit engine will shut off.

^If power unit is equipped with PTO remote kit # 70.4106 and is using an attachment with a remote PTO shut-off switch, the safety interlock system performs additional functions.

### Testing the Safety Interlock System

#### ⚠ WARNING

Never operate the power unit if the safety interlock system is malfunctioning. Do not disengage or bypass any switch. Failure to heed warning could result in injury to yourself and others, or damage to property.

#### ⚠ WARNING

Release of the parking brake will be required during the safety interlock system test. Place wheel chocks in front and back of wheels to prevent the power unit from rolling.

#### ⚠ CAUTION

The daily inspection should be performed prior to initial startup for the day.

Perform the following safety interlock tests daily to test the electrical portion of the interlock system. Before testing, park the power unit on a level surface, place wheel chocks in front and back of wheels, and place the high/low range shift lever in the neutral position. After testing is complete, place the high/low shift lever in either high or low range, set the parking brake, and remove the wheel chocks.

**Tests 1-4** test the 'Engine Start' function. For each test, turn the key to the RUN position (do not start the engine). As listed for each test, engage or disengage the parking brake\*, place the SDLA in neutral or out of neutral^, and sit on the seat or raise body weight from seat. The engine starter should or should not engage as described for each test.

	Test Number	Parking Brake* Engaged	Forward/Reverse Control (SDLA) in Neutral^	Operator Present in Seat	Engine Starts
<b>Engine Start</b>	1	No	Yes	Yes	No
	2	Yes	No	Yes	No
	3	Yes	Yes	No	Yes
	4	Yes	Yes	Yes	Yes

\*This tests the function of the parking brake switch. The parking brake handle should be engaged the minimum amount necessary to activate the parking brake indicator light on the warning gauge. Neutral assist must be off.

^This tests the function of the neutral switch located on the hydraulic pump. Depending on settings and the age of the power unit, the range of neutral for the SDLA Control may vary. For this test, the SDLA lever should move 1 inch (2.54 cm) or less forward or backward for neutral switch activation (measured at the top of the lever).

# SAFETY

## Testing the Safety Interlock System (continued)

**Tests 5-9** test the 'Engine Run' function. For each test, start the power unit so that the engine is running. As listed for each test, engage or disengage the parking brake\*, place the SDLA in neutral or out of neutral^, and sit on the seat or raise body weight from seat. The engine should continue running or stop running as described for each test.

	Test Number	Parking Brake* Engaged	Forward/Reverse Control (SDLA) in Neutral^	Operator Present in Seat	Engine Runs
<b>Engine Run</b>	5	Yes	Yes	Yes	Yes
	6	Yes	Yes	No	Yes
	7	Yes	No	No	No
	8	Yes	No	Yes	No
	9	No	Yes	No	No

**Tests 10-13** test the 'PTO' function. For each test, turn the key to the RUN position (do not start the engine). As listed for each test, place the PTO switch in the ON or OFF position and sit on the seat or raise body weight from seat. The electric PTO clutch will make an audible noise when it engages or disengages.

	Test Number	PTO Switch	Operator Present in Seat	PTO Clutch
<b>PTO</b>	10	Off	Yes	Off
	11	Pull to 'On' Position	No	No
	12	Pull to 'On' Position	Yes	Yes
	13	On	Raise Operator Body Weight from Seat	PTO Disengages (1/2 second delay)

If the power unit fails any one of the safety interlock tests, refer to the troubleshooting section for using the TCM (tractor control module) to diagnose electrical problems.

\*This tests the function of the parking brake switch. The parking brake handle should be engaged the minimum amount necessary to activate the parking brake indicator light on the warning gauge. Neutral assist must be off.

^This tests the function of the neutral switch located on the hydraulic pump. Depending on settings and the age of the power unit, the range of neutral for the SDLA Control may vary. For this test, the SDLA lever should move 1 inch (2.54 cm) or less forward or backward for neutral switch activation (measured at the top of the lever).

# OPERATIONAL CONTROLS

## Standard Operational Control Locations

Use the following images to help identify the locations of operational controls. The letter next to each control can be referenced to the list that follows these images.

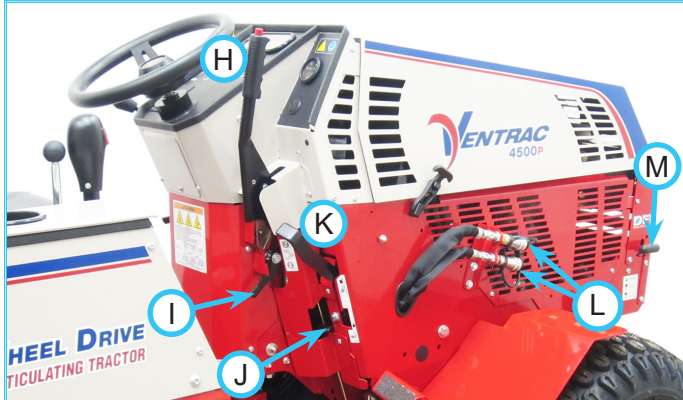
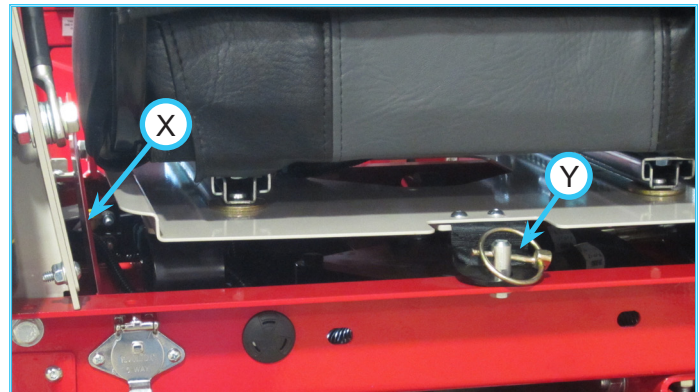
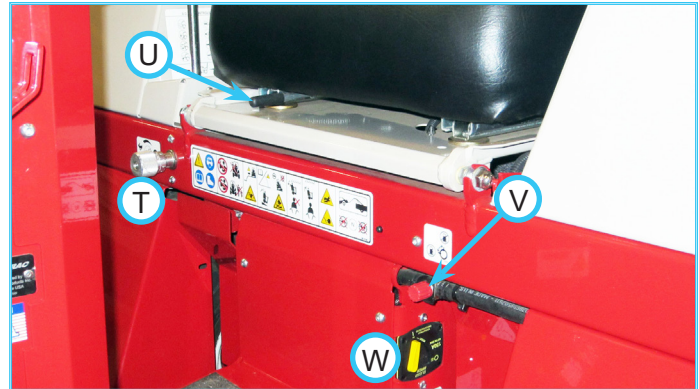

- A. Information Cluster Gauge
- B. Warning Cluster Gauge
- C. Warning Alarm (Continuous)
- D. Ignition Switch
- E. Throttle Lever
- F. Headlight Switch
- G. PTO Switch
- H. Parking Brake
- I. Neutral Assist Lever
- J. Front Hitch Lever Lock
- K. Front Hitch Latch Lever
- L. Auxiliary Hydraulic Quick Couplers
- M. PTO Belt Tensioner Rod
- N. High/Low Shift Lever
- O. Weight Transfer Select Lever
- P. Primary SDLA Control Lever
- Q. Secondary SDLA Control Lever
- R. Steering Wheel
- S. Hydraulic Cooler Fan Switch
- T. Front Hitch Valve
- U. Seat Slide Lever
- V. Fuel Shut-off Valve
- W. Circuit Breaker & Battery Disconnect
- X. Seat Prop Plate
- Y. Seat Latch Strap

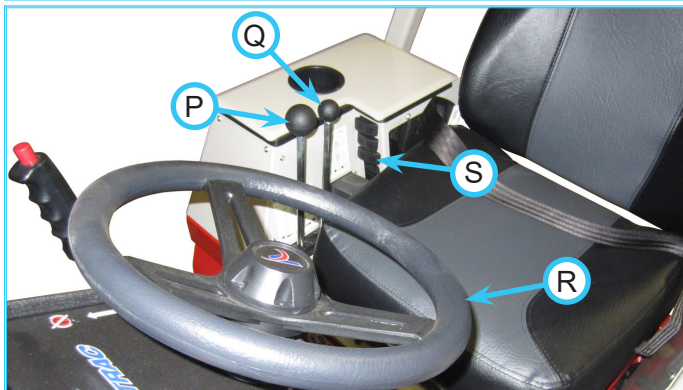

# OPERATIONAL CONTROLS

## Optional Operational Control Locations

Use the following images to help identify the locations of operational controls for optional kits. The letter next to each control can be referenced to the list that follows these images.

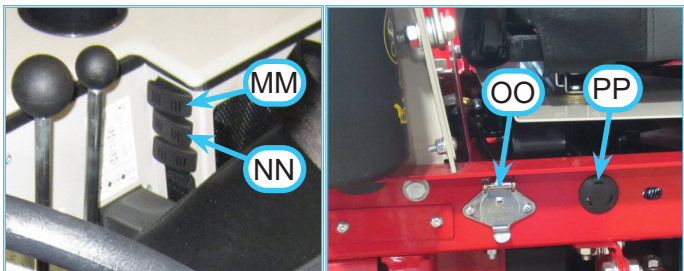
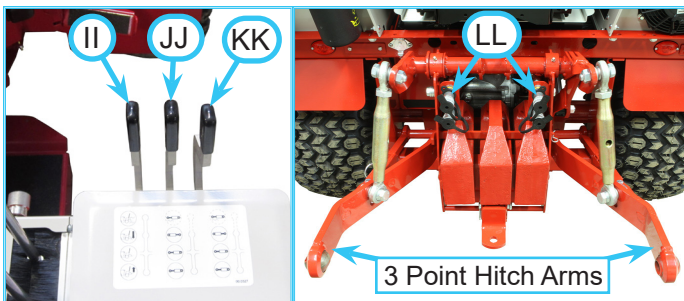
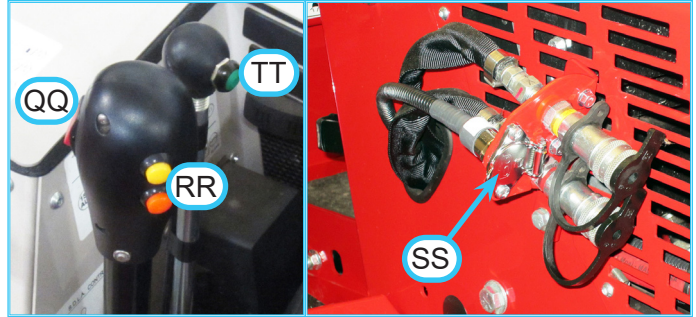

- AA. Work Light Switch
- BB. Strobe Light Switch
- CC. Slope Indicator Gauge
- DD. Slope Warning Light
- EE. Directional Signal Switch
- FF. Hazard Flasher Switch
- GG. Horn Switch
- HH. Foot Pedal
- II. 3 Point Hitch Control Handle
- JJ. Left Rear Auxiliary Hydraulics Handle
- KK. Right Rear Auxiliary Hydraulics Handle
- LL. Rear Auxiliary Hydraulic Quick Couplers
- MM. Rear 12V Switch (On/Off)
- NN. Rear 12V Switch (Momentary On/Off/On)
- OO. Rear 12V 4-Pin Socket
- PP. Back Up Alarm
- QQ. Front 12V Switch (On/Off)
- RR. Front 12V Switch (Momentary On/Off/On)
- SS. Front 12V 4-Pin Socket
- TT. Dual Hydraulic Front Coupler Switch
- UU. Seat Slide Lever
- VV. Lumbar Support Knob
- WW. Backrest Angle Lever
- XX. Weight Adjustment Lever
- YY. Optional Armrest Angle Knob

# OPERATIONAL CONTROLS

## Information Cluster Gauge (A)



1. Tachometer
2. Speedometer
3. Hour Meter
4. Water Temperature Gauge
5. Fuel Gauge
6. Glow Plug Indicator Light

The information cluster gauge contains a tachometer, speedometer, hour meter, water temperature gauge, fuel gauge, and glow plug indicator light (diesel engine only).

The **tachometer** displays the engine speed in RPM.

The **speedometer** displays the speed of the power unit. The speedometer can be set to display either miles per hour (mph) or kilometers per hour (kph).

The **hour meter** records the accumulated time the ignition key has been switched to the on position.

The **water temperature gauge** displays the temperature of the engine cooling system.

The **fuel gauge** displays the level of fuel in the tank.

The **glow plug indicator light** indicates activation of the glow plugs for preheating the engine (diesel engine only).

## Warning Cluster Gauge (B)

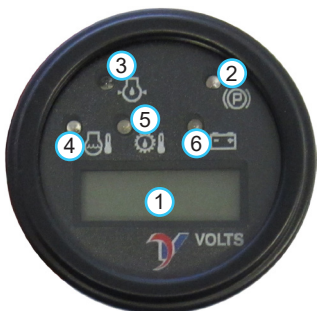

1. Volt Meter
2. Park Brake Indicator Light
3. Low Engine Oil Pressure Warning Light
4. High Water Temperature Warning Light
5. High Hydraulic Fluid Temperature Warning Light
6. Low Voltage Warning Light

The warning cluster gauge contains a volt meter, a park brake indicator light, low engine oil pressure warning light, high water temperature warning light, high hydraulic fluid temperature warning light, and low voltage warning light.

The **volt meter** displays the voltage level of the charging system.

The **park brake indicator light** activates when the park brake is set.

The **low engine oil pressure warning light** activates when the engine oil pressure is below safe levels. The light comes on when the ignition key is switched to the on position and stays illuminated until the engine is started and safe oil pressure develops. If this light comes on during operation, immediately shut off the engine. Do not restart the engine until the problem has been located and corrected.

The **water high temperature warning light** activates when the temperature of the engine cooling systems reaches unsafe levels. If this light comes on during operation, park the power unit, turn the PTO off, reduce engine speed to low idle, and allow the engine to cool. Check the radiator screen and clean, if necessary. If engine temperature continues to rise, shut off the engine. If the engine continually overheats, refer to the troubleshooting section for possible problems.

The **hydraulic fluid high temperature warning light** activates when the hydraulic fluid reaches unsafe levels. If this light comes on during operation, park the power unit and move the throttle lever to the idle position. Check the hydraulic cooling fan to ensure it is operating properly and refer to the troubleshooting section for possible problems.

The **low voltage warning light** activates when the voltage drops to unacceptable levels. If this light comes on, shut off any unnecessary lights and accessories to reduce current draw. If voltage continues to drop, park the power unit, shut off the engine, and turn the ignition key to the off position. Refer to the troubleshooting section for possible problems.

## Warning Alarm (C)

The warning alarm works with the warning cluster gauge to alert the operator to problems. The warning alarm sounds a continuous signal whenever a warning is displayed on the warning cluster gauge. If the warning alarm sounds, immediately check the warning cluster gauge to determine the cause of the warning and then take appropriate action.

## Ignition Switch (D)

1. Off or Stop Position - all 12 volt power going through the key switch is off.
2. On or Run Position - engine run position, 12 volt power is sent to accessories.
3. Start Position - when the key is turned to the start position, the starter will engage.

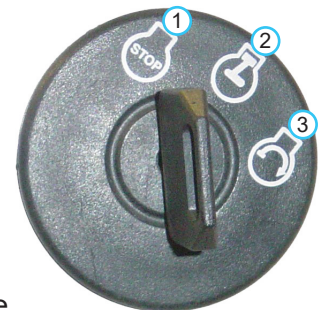



# OPERATIONAL CONTROLS

## Throttle Lever (E)

Moving the throttle lever forward toward the fast position increases the engine Revolutions Per Minute (RPM). Moving the throttle lever backward toward the slow position decreases the engine RPM.

1. Fast
2. Slow



## Headlight Switch (F)

Depressing the top (1) of the headlight switch turns on the headlights and taillights. Depressing the bottom (2) of the switch turns the lights off.

1. On
2. Off



## Power Take Off (PTO) Switch (G)

Pulling up on the PTO switch engages the electric clutch to provide power to the front attachment.

Pushing down on the PTO switch disengages the electric clutch and applies the clutch brake to stop the attachment. NOTE: the PTO will turn off automatically if the operator leaves the seat. The PTO can be restarted by turning the PTO switch off and then on again.



1. PTO Off
2. PTO On

## Parking Brake (H)

When parking the power unit, always engage the parking brake to prevent accidental movement of the machine.

To engage the parking brake, pull the brake handle back toward the operator.

To disengage the parking brake, pull back slightly on the brake handle to relieve pressure, push down the release button (3) on the top of the handle, and push the handle forward.

If the parking brake is set, any attempt to move the power unit will shut off the engine. If the operator leaves the seat without first setting the parking brake, the engine will shut off.

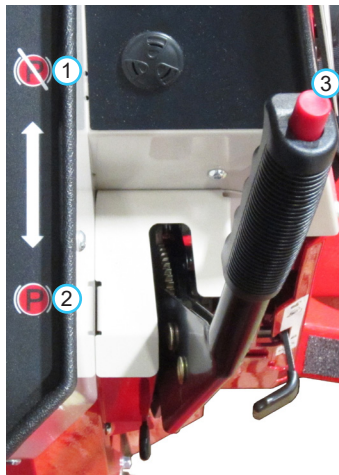

1. Parking Brake Disengaged
2. Parking Brake Engaged (Set)
3. Parking Brake Release Button

## Neutral Assist Lever (I)

Placing the neutral assist lever in the on position (2) engages the neutral assist spring to help return the SDLA control levers to the neutral position. This makes the neutral position easy to select and maintain. The neutral assist on position is recommended when learning the operation of the power unit, loading or unloading, attaching and removing attachments, and whenever the operator is unsure of the power unit's response to the task being performed.

Placing the neutral assist lever in the off position (1) disengages the neutral assist spring. This position is designed for experienced operators when using the power unit in open areas where travel speed and direction are relatively constant and control is easily maintained. The neutral assist off position reduces operator arm fatigue when using the power unit for prolonged periods of time.

1. Neutral Assist Off
2. Neutral Assist On

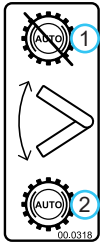

## CAUTION

Stopping the power unit with the neutral assist lever in the off position requires the operator to manually return the SDLA control lever or foot pedal to the neutral position.

## Front Hitch Lever Lock (J)

The front hitch lever lock prevents the accidental release of the front hitch latch lever. To release the front hitch latch lever, lift the tab on the front hitch lever lock and then move the front hitch latch lever to the unlock position.

## Front Hitch Latch Lever (K)

The front hitch latch lever locks or unlocks the hitch latch.

Raise the front hitch latch lever to unlock the hitch latch when attaching or detaching Ventrac attachments.

Lower the front hitch latch lever to lock the hitch latch over the hitch arm pins on Ventrac attachments. Ensure the lever is secured in the frame notch and the front hitch lever lock is in place.

1. Unlocked
2. Locked

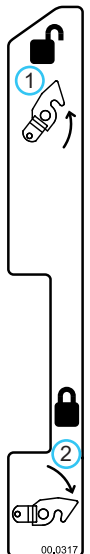

## Auxiliary Hydraulic Quick Couplers (L)

The two couplers are a part of the auxiliary hydraulic circuit and are used with an attachment which requires hydraulics (e.g. to angle a dozer blade or rotate the discharge on the snow blower).

# OPERATIONAL CONTROLS

## PTO Belt Tensioner Rod (M)

The PTO belt tensioner rod applies or releases belt tension to the attachment drive belt.

After placing the attachment drive belt onto the PTO drive pulley, pushing the PTO belt tensioner rod in (1) until it locks applies tension to the attachment drive belt.

Pulling the the PTO belt tensioner rod out (2) releases the belt tension, allowing the operator to remove or install the attachment drive belt.

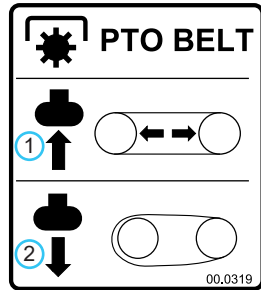

1. Belt Tension Engaged
2. Belt Tension Released

## High/Low Shift Lever (N)



### Attention

The high/low range shift lever shifts both the front and rear transaxles simultaneously. Occasionally the engagement of the transaxle gears is prevented by misalignment. Moving the steering wheel slightly to the right or left will move the gears enough to complete the engagement.



### CAUTION

Never shift while under load, while moving, or while on a slope. Always ensure the shift lever is secured in the lock position at the end of each shift stroke. Always install the ball pin to prevent the shift lever from being accidentally moved to the neutral position.

With the power unit parked on level ground, remove the ball pin (A) and push the shift lever forward to select low range (1).

Move the shift lever to middle of the shift stroke to place the transaxle gears in neutral (0).

Pull the shift lever back toward the operator to select high range (2).

Ensure the shift lever is secured in the lock position at the end of each shift stroke.

Reinstall the ball pin (A) into the shift select bracket position at the same end of the bracket as the shift lever, in order to prevent the shift lever from being accidentally disengaged.

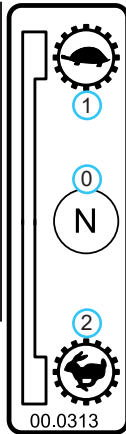
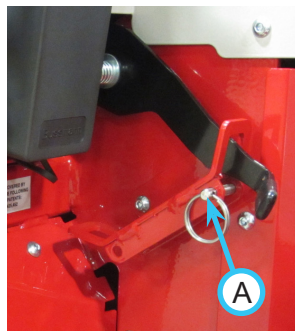

0. Neutral
1. Low Range
2. High Range

## Weight Transfer Traction Control Select Lever (O)

The weight transfer system transfers weight from the attachment to the front wheels of the power unit. Transferring weight from the attachment to the power unit increases the traction control, improves hillside maneuverability, aids in lifting the attachment, reduces steering effort, and lessens the attachment resistance when in contact with the ground.

The operator can select different transfer rates by selecting one of the five positions from no weight transfer (0) to maximum weight transfer (4). Set the weight transfer to 0 when attaching or detaching any attachment.

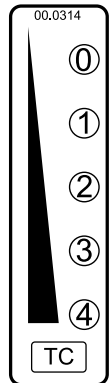

# OPERATIONAL CONTROLS

## SDLA Control Lever (P & Q)

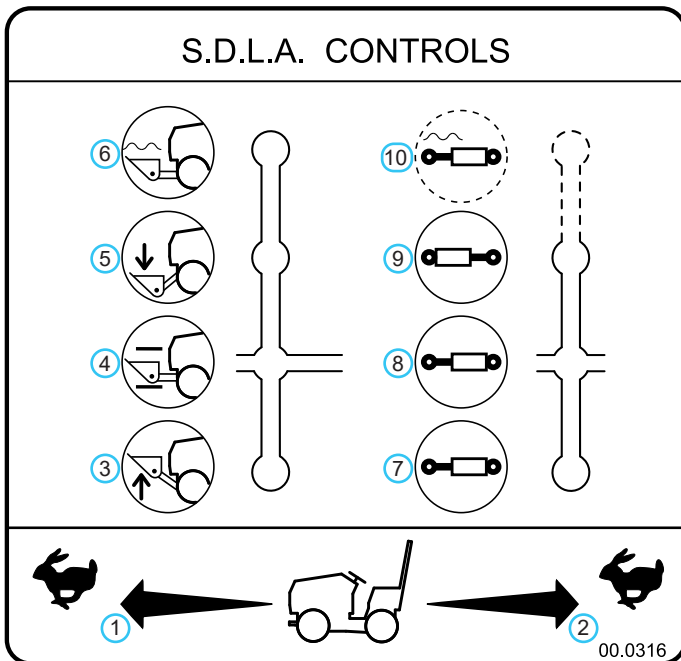

- |                      |                         |
|----------------------|-------------------------|
| 1. Forward Direction | 6. Float                |
| 2. Reverse Direction | 7. Direction #1         |
| 3. Lift              | 8. Hold                 |
| 4. Hold              | 9. Direction #2         |
| 5. Lower             | 10. Float (if equipped) |

The SDLA (Speed, Direction, Lift, and Auxiliary) is the primary control for the power unit and consists of two levers. The primary SDLA control lever (P) controls the speed, direction of travel, and lift of the hitch arms. The secondary SDLA control lever (Q) controls the auxiliary hydraulic circuit.

- S - Speed:** the amount of forward or backward movement of the primary SDLA lever controls the ground speed of the power unit.
- D - Direction:** the forward or backward movement of the primary SDLA lever controls the direction of the power unit.
- L - Lift:** the lift function of the primary SDLA lever has four positions: Up, Hold, Down, and Float Lock. "Hold" is the default position; this holds the lift arms from moving up or down. Pulling the lever to the left raises the hitch arms. Pushing the lever to the right lowers the hitch arms. Float position is attained by pushing the lever to the right until the float detent locks the lever in place.
- A - Auxiliary:** the left or right movement of the secondary SDLA lever controls the functions of attachments that require the auxiliary hydraulic circuit. An optional float kit (part # 23.0111-7) is available for the auxiliary circuit.

## Steering Wheel (R)

Turn the steering wheel to the left (counterclockwise) to turn the power unit to the left. Turn the wheel to the right (clockwise) to turn the power unit to the right.

## Hydraulic Cooler Fan Switch (S)

The hydraulic oil cooler fan switch is normally set to the automatic thermostatically controlled position (1). This allows the thermostat to turn on the cooling fan when the hydraulic fluid reaches the set temperature. The fan pulls air through the right fender next to the operator, through the oil cooler, and discharges the air out the back of the power unit. The switch can be set to the reverse position (2) to pull air from the back of the power unit, through the oil cooler, and discharge the warm air next to the operator. This feature can be used to help provide warmth for the operator during cold weather.

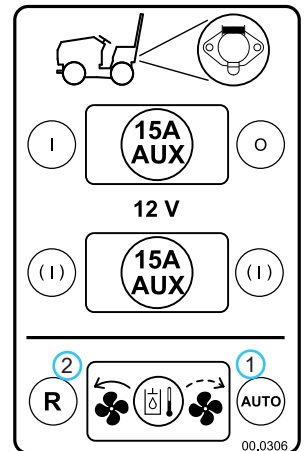

- 11. Normal (auto) Operation
- 12. Reverse Operation

## Front Hitch Valve (T)

The front hitch valve is used to control the lowering of the front hitch.

Turning the knob on the front hitch valve counterclockwise

increases the speed at which the front hitch and attachment can be lowered.

Turning the knob clockwise decreases the speed at which the front hitch and attachment can be lowered.

The front hitch and attachment can be locked in any position so that it will not lower, by turning the front hitch valve knob clockwise until it is completely closed. When operating 3-point hitch implements, it may be helpful to lock the front hitch and attachment in a raised position, to prevent accidental lowering of the front attachment.

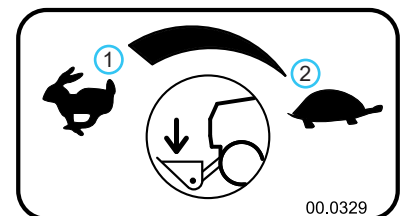

- 1. Fast
- 2. Slow/Locked

## Seat Slide Lever (U)

Move the seat slide lever to the left to release the seat lock. Move the seat forward or backward to the desired position and release the seat slide lever to lock the seat in place.

# OPERATIONAL CONTROLS

## Fuel Shut-off Valve (V)

The fuel shut-off valve controls the flow of fuel to the power unit engine. Turning the valve counterclockwise (1) to the stop allows fuel to flow to the engine.

Turning the valve clockwise (0) to the stop shuts off the fuel flow to prevent fuel leakage when changing fuel filters or servicing the fuel system. Turn off the fuel shut-off valve when transporting the power unit on a truck or trailer and when parking the power unit indoors.

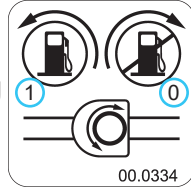

- 0. Fuel Off
- 1. Fuel On

## Strobe Light Switch (BB)

Depressing the top (1) of the strobe light switch turns on the strobe light. Depressing the bottom (2) of the switch turns the strobe light off.

- 1. On
- 2. Off

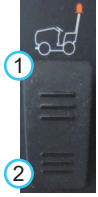

## Circuit Breaker & Battery Disconnect (W)

The circuit breaker/battery disconnect switch controls power to the entire electrical system. Turning the switch to position 0 disables the electrical system, allowing electrical components to be serviced.

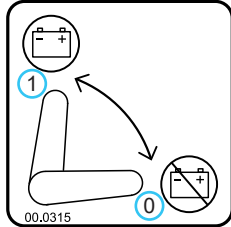

- 0. Electrical Power Off
- 1. Electrical Power On

## Seat Prop Plate (X)

The seat prop plate secures the seat in the flipped forward position while service is performed under the seat.

To secure, tilt the seat forward, lift up the seat prop plate, and insert the end into the wide portion of the seat plate slot. Ensure the seat prop plate snaps into the narrow portion of the slot to prevent accidental release.



To release, move the seat prop plate over into the wide portion of the seat slot and tilt the seat forward. Lower the seat prop plate back into the seat box and lower the seat back down to the operating position.

## Seat Latch Strap (Y)

The seat latch strap secures the seat during transport of the power unit.

To secure the seat, place the tab on the end of the seat latch strap over the seat latch pin. Install the linch pin through the hole in seat latch pin to secure.

To release the seat so that it can be tilted forward for service, remove the linch pin and lift the tab on the seat latch strap off the seat latch pin.

## Work Light Switch (AA)

Depressing the top (1) of the work light switch turns on the work lights. Depressing the bottom (2) of the switch turns the work lights off.

- 1. On
- 2. Off



## Slope Indicator Gauge (CC) (70.4112 & 70.4140)

The 70.4112 digital slope indicator gauge works with a bidirectional slope meter to display the angle of a slope in degrees. NOTE: sudden changes in speed or direction may affect the slope value displayed.

The 70.4140 slope indicator gauge is designed to monitor the total slope angle of the terrain where the power unit is operating. Total slope angle combines side-to-side angle with front-to-back angle to provide a true overall measurement of slope angle, regardless of power unit orientation. The slope gauge has slope limit set-points that can be changed to match the capability of the power unit configuration along with attachments that might limit the slope rating of the power unit. The slope gauge is equipped with both audible and visual alerts which can be set independently to warn the operator of limiting conditions. The display screen has multiple options to suit operator preference.

Refer to Slope Gauge Settings & Operation section for calibration, settings, and operation instructions.

## Slope Warning Light (DD) (70.4112 Only)

The slope warning light works with the 70.4112 slope indicator system to provide a visual warning when the slope value exceeds 20 degrees.

## Directional Signal Switch (EE)



- 1. Left Turn Signal
- 2. Right Turn Signal

Pressing the left portion of the directional signal switch turns on the left turn signal. Pressing the right portion of the directional signal switch turns on the right turn signal. Return the switch to the middle position to turn off the signals. The left and right turn signals will override the hazard flashers.

# OPERATIONAL CONTROLS

## Hazard Flasher Switch (FF)



1. Hazard Flasher On
2. Hazard Flasher Off

Depressing the right portion of the hazard flasher switch flashes both directional turn signal lights. Depressing the left portion of the switch turns the hazard flasher lights off. Use of the directional turn signals will override the hazard flashers until the turn signals are turned off.

## Horn Switch (GG)

Press the horn switch to sound the signal horn. The horn will sound until the horn switch is released.

1. Horn Signal



## Foot Pedal (HH)

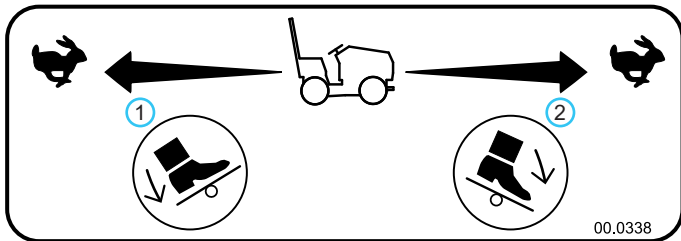

1. Reverse Direction
2. Forward Direction

The foot pedal works in conjunction with the SDLA control lever and can be used to control the speed and direction of the power unit when the operator's hand is removed from the SDLA lever.

Press down on the front portion of the foot pedal to move the power unit in the forward direction. Press down on the rear portion of the foot pedal to move the power unit in the reverse direction. Changing the amount the foot pedal is depressed will immediately change the ground speed of the power unit.

To slow or stop (brake) the power unit, press down on the opposite portion of the foot pedal (i.e. if you are traveling forward, press down on the rear portion of the foot pedal).

## 3 Point Hitch & Rear Auxiliary Control Handles (II, JJ, & KK)

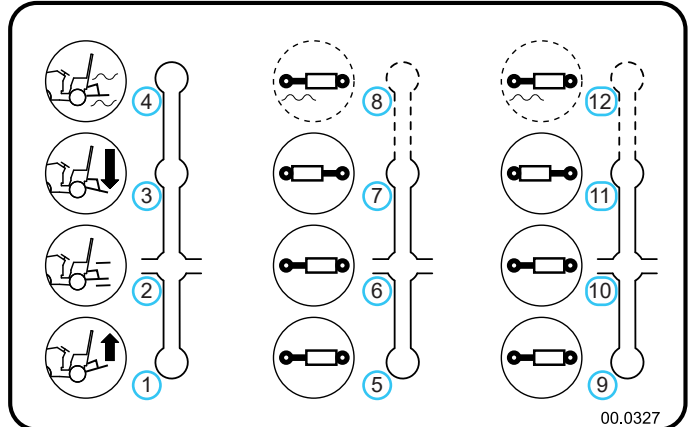

- |  |   |
|--|---|
| 1. 3 Point Hitch Lift                        | 8. Left Auxiliary Hyd. Couplers Float (if equipped)   |
| 2. 3 Point Hitch Hold                        | 9. Right Auxiliary Hyd. Couplers Direction #1         |
| 3. 3 Point Hitch Lower                       | 10. Right Auxiliary Hyd. Couplers Hold                |
| 4. 3 Point Hitch Float                       | 11. Right Auxiliary Hyd. Couplers Direction #2        |
| 5. Left Auxiliary Hyd. Couplers Direction #1 | 12. Right Auxiliary Hyd. Couplers Float (if equipped) |
| 6. Left Auxiliary Hyd. Couplers Hold         |   |
| 7. Left Auxiliary Hyd. Couplers Direction #2 |   |

The left control handle (II) controls the position of the 3 point hitch arms. Pulling up on the handle raises the 3 point hitch arms. Pushing down on the handle lowers the 3 point hitch arms. Float position is attained by pushing the handle down until the float detent locks the handle in place.

The middle control handle (JJ) controls the left rear set of hydraulic quick couplers. Pull the handle up to activate the attachment hydraulic cylinder in direction #1. Push the handle down to activate the attachment hydraulic cylinder in direction #2.

The right control handle (KK) controls the right rear set of hydraulic quick couplers. Pull the handle up to activate the attachment hydraulic cylinder in direction #1. Push the handle down to activate the attachment hydraulic cylinder in direction #2.

## Rear Auxiliary Quick Couplers (LL)

The rear auxiliary hydraulic quick couplers are used to control auxiliary functions of attachments that are being used with the 3 point hitch. The 3 point hitch includes 2 sets of hydraulic quick couplers.

# OPERATIONAL CONTROLS



## Attention

The front and rear 4-pin sockets are designed for use with Ventrac original equipment only. These connectors (4-pin socket) are rated for 20 amp maximum current draw. Engine alternator and/or battery capacity determine allowable continuous draw.

### 12 Volt Rear Switches & 4-Pin Socket (MM, NN, & OO)

The rear 4-pin socket provides electrical power to rear mounted attachments that are equipped with electrical controls. (e.g. ES220 Spreader)

The switches turn off and on the electrical power to the rear 4-pin socket.

Depressing the right portion (1) of the on/off switch turns on electrical power to the 4-pin socket.

Depressing the left portion (2) of the switch turns off electrical power.

Depressing the right (3) or left (4) portion of the mo/off/mo switch turns on electrical power to the 4-pin socket. Releasing the switch turns off electrical power.

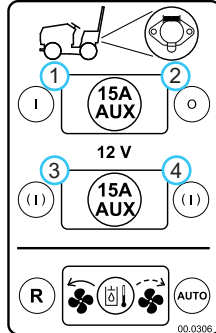

1. On
2. Off
3. Momentary On
4. Momentary On

### Back Up Alarm (PP)

The back up alarm emits an intermittent signal when the power unit is operated in reverse to alert nearby persons that the power unit is backing up.

### 12 Volt Front Switches & 4-Pin Socket (QQ, RR, & SS)

The front 4-pin socket provides electrical power to attachments that are equipped with electrical controls. (e.g. broom rotation actuator, snow blower discharge chute angle)

The switches turn off and on the electrical power to the front 4-pin socket.

Depressing the top portion (1) of the on/off switch turns on electrical power to the 4-pin socket. Depressing the bottom portion (2) of the switch turns off electrical power.

Depressing either the top (3) or bottom (4) momentary on switch turns on electrical power to the 4-pin socket. Releasing the switch turns off electrical power.

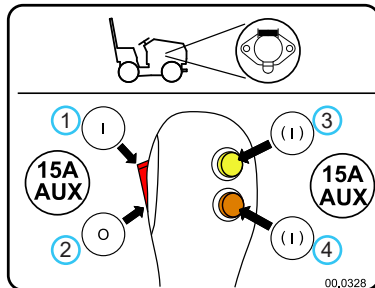

1. On
2. Off
3. Momentary On
4. Momentary On

### Dual Hydraulic Front Coupler Switch (TT)

The optional switch handle is part of the dual front hydraulic auxiliary kit and is used to control which set of quick couplers is controlled by the secondary SDLA lever. The secondary SDLA lever operates the hydraulic couplers with red and yellow indicators until the button on the handle is depressed. Pressing the button switches the secondary SDLA lever to control the operation of the hydraulic couplers with white and black indicators. Release the button to return to normal operation.

### Seat Slide Lever (UU)

Lift the seat slide lever to release the seat lock. Move the seat forward or backward to the desired position and release the seat slide lever to lock the seat in place.

### Lumbar Support Knob (VV)

The lumbar support knob adjusts the curvature of the backrest in either the upper or lower part of the backrest.

Position 0 provides minimal support.

Position 1 provides maximum curvature in the upper part of the backrest.

Position 2 provides maximum curvature in the lower part of the backrest.

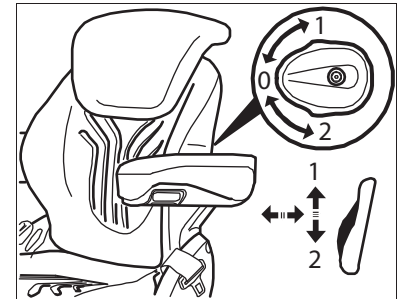

### Backrest Angle Lever (WW)

Lift up on the backrest angle lever to release the backrest catch. Move the backrest to the desired position and release the backrest angle lever to lock the backrest in place.

# OPERATIONAL CONTROLS

---

## Weight Adjustment Lever (XX)

The weight setting must be adjusted with the operator sitting on the seat. The weight setting should be checked and adjusted as necessary each time the power unit is operated.

Fold the weight adjustment lever out and move it up or down to adjust the weight setting. The weight setting is correct when the arrow is in the middle of the viewing window.

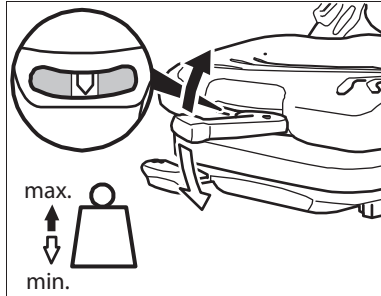

After adjusting the weight setting, fold the adjustment lever completely into the locking position.

## Optional Armrest Angle Knob (YY)

The angle of the optional armrests can be adjusted individually by rotating the knob on the underside of the armrest to raise or lower the front of the armrest.

# GENERAL OPERATION

## Daily Inspection

### **WARNING**

Always set the parking brake, shut off power unit engine, remove the ignition key, and ensure all moving parts have come to a complete stop before inspecting components, or attempting any repair or adjustment.

1. Park the power unit on a level surface, with the engine shut off and all fluids cold.
2. Perform a visual inspection of the power unit. Look for loose or missing hardware, damaged components, or signs of wear.
3. Inspect the ROPS structure and seat belt for damage or signs of wear.
4. Inspect the battery, electrical connections, and lights.
5. Ensure parking brake tension is properly adjusted.
6. Inspect hydraulic hoses, hydraulic fittings, and fuel lines to ensure tight, leak free connections.
7. Inspect belts for damage or excessive wear. Service as required.
8. Check the power unit's engine oil level, hydraulic oil level, coolant level (if equipped), and fuel level. Add fluid or service as required.
9. Ensure the radiator screen (if equipped), air cleaner, and engine compartment are clean.
10. Check tires for proper inflation.
11. Test the operator safety interlock system.

## Starting The Engine

### **CAUTION**

Do not use ether or starting fluids. Use of starting fluids in the air intake system may be potentially explosive or cause a runaway engine condition. Use of starting fluids could result in engine damage and/or personal injury.

### **CAUTION**

Allow time for hydraulic oil to circulate before operating the power unit. Severe damage could result to the hydraulic system if adequate warm up isn't allowed. Warm up time is increased in colder weather.

The 4500 is equipped with an interlock system for operator safety. The safety interlock system requires the parking brake to be engaged and the SDLA lever to be in the neutral position.

1. Turn the fuel shut-off valve to the On position.
2. Turn the battery disconnect switch to the On position.
3. Move the throttle lever to the half throttle position. (Engine is fuel injected; there is no choke.)

### **CAUTION**

Do not run the electric starter continuously for more than 5 seconds. If the engine does not start right away, wait 15 seconds and try again.

4. Turn the ignition key to the start position and hold to engage the starter. Release the key when the engine starts. NOTE: if engine fails to start, refer to the troubleshooting section.
5. The engine and hydraulic oil must be warmed to operating temperature before operations. Allow the unit to run at approximately 1800 rpm until the hydraulic filter is warm to touch. The hydraulic filter is located below the front fuse panel to the left of the dash.



# GENERAL OPERATION

## Forward And Reverse

Set the neutral assist lever to the desired position. Verify that the intended path is safe and free from obstacles. When safe to move, begin by disengaging the parking brake.

### ⚠ WARNING

Never remove your right hand from the SDLA control lever unless you are using an optional foot pedal to control speed and direction. All direction, speed, and braking are controlled by the SDLA lever or the foot pedal. Depending on the terrain or rate of speed, more force may be required to maintain speed, change direction, or brake. Your hand or foot must always be ready to brake or stop the power unit.

Power unit movement is controlled by moving the SDLA control lever in the desired direction of travel. Push the SDLA control lever forward to move power unit in the forward direction. Pull the SDLA control lever backward to make the power unit move in the reverse direction. Changing the amount the SDLA control lever is moved instantly changes the ground speed of the power unit. Moving it one half of the stroke will result in approximately one half of the maximum ground speed. Moving it to the end of the stroke will result in maximum ground speed.

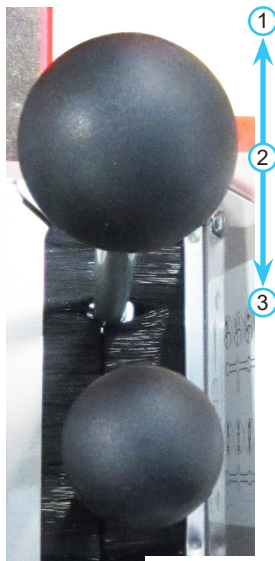

1. Forward
2. Neutral
3. Reverse

If the power unit is equipped with an optional foot pedal, the foot pedal can be used to control speed and direction instead of the SDLA control lever.

The SDLA control should be used for precision control in tight spaces or when connecting an attachment. The foot pedal is better suited to controlling speed and direction in open areas.

## Stopping The Power Unit

To slow or stop the power unit, move the SDLA control lever in the opposite direction that you are traveling. Return the SDLA control lever to the neutral position to make a complete stop.

If the power unit is equipped with an optional foot pedal, the foot pedal can be used to control speed and direction instead of the SDLA control lever.

If in the case of an emergency, the power unit cannot be stopped with the SDLA control lever, pull back the parking brake lever to engage the parking brake.

### ⚠ CAUTION

If the parking brake is engaged while the power unit is moving, the engine will shut off and the power unit will come to an abrupt stop.

## Shutting Off The Engine

1. Park the power unit on a level surface and set the parking brake.
2. Move the throttle lever to the slow idle position.
3. Allow the engine to idle for 3-5 minutes.
4. Turn the ignition key to the off position and remove the key from the ignition switch.
5. When parking the power unit at the end of the day, turn the battery disconnect switch and the fuel shut-off valve to the Off positions.

## Attaching

1. Drive the power unit slowly forward into the hitch arms of the attachment. Align the lift arms of the power unit with the attachment hitch arms by raising or lowering the front hitch and complete the engagement.
2. Once completely engaged, move the front hitch latch lever to the locked position.
3. Engage the parking brake and shut off the engine.
4. Release the PTO belt tensioner rod.\*
5. Place the attachment belt onto the PTO drive pulley on the power unit. Ensure the belt is properly seated in each pulley.\*
6. Engage the PTO belt tensioner rod.\*
7. Wipe the attachment's hose ends clean, and connect to the power unit's hydraulic quick couplers.\* If equipped, connect the hoses and quick couplers so the red indicators are paired together and the yellow indicators are paired together.
8. Connect the electric plug to the matching socket.\*

Refer to attachment manual for additional details.

\*Applies only if the attachment is equipped.

# GENERAL OPERATION

## Detaching

1. Park the power unit on a level surface and set the parking brake.
2. Fully raise the front hitch and attachment and set the weight transfer to 0 (if equipped).
3. Lower the attachment to the ground and place the primary SDLA lever in the float position.
4. Shut off power unit engine.
5. Release the PTO belt tensioner rod.\*
6. Remove the attachment belt from the PTO drive pulley of the power unit.\*
7. Move the secondary SDLA lever left and right to release pressure from the auxiliary hydraulic circuit and disconnect the hydraulic quick couplers from the power unit.\*
8. Disconnect the electric plug from the socket on the power unit.\*
9. Lift the front hitch lever lock to release the front hitch lock lever and move the front hitch lock lever to the unlocked position.
10. Restart the power unit and slowly back away from the attachment.

Refer to attachment manual for additional details.

\*Applies only if the attachment is equipped.

## Operating Attachments

Refer to the operator's manual for each attachment for the proper operation and use of the particular attachment that is being operated.

## Front Hitch

The front hitch is used to secure attachments to power unit, and to raise and lower the attachment. The front hitch is controlled by the primary SDLA lever. Pull the lever to the left to raise the attachment, push the SDLA lever to the right to lower the attachment. The primary SDLA is equipped with a 'float' position. Push the SDLA lever to the far right position until the float detent engages and stays in place to operate in float.

## PTO Drive Belt & Pulley

If the attachment requires a drive belt, release the PTO belt tensioner rod and install the attachment belt around the drive pulley at the location shown above. When the belt is in place around the drive pulley, push the PTO belt tensioner rod in to engage and tighten the belt.

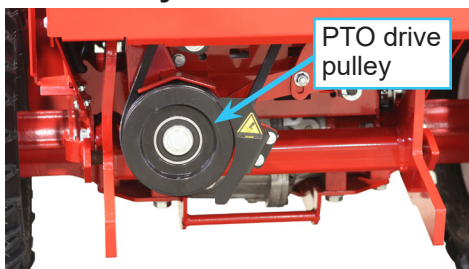

## Front Auxiliary Couplers

### CAUTION

#### EQUIPMENT DAMAGE!

Dirt and other debris in hydraulic system can cause damage to the system. Wipe clean the mating parts of the couplers before coupling. Use protective rubber plugs over hydraulic couplers when not in use.

If attachment requires auxiliary hydraulics, couple the attachment hoses with the front auxiliary couplers. This is done by sliding the collar of the coupler rearward and inserting the end of the attachment hose into the coupler and releasing the collar. If the collar will not snap forward on its own, pull it forward manually.

The couplers that the hoses are attached to will affect which way the secondary SDLA lever is pushed to control the action of the attachment. If the attachment is equipped with red and yellow indicators, connect the hoses and quick couplers so the red indicators are paired together and the yellow indicators are paired together. If the hoses are connected and the action is not the desired motion, then switch the hoses the couplers are attached to.

Auxiliary couplers are controlled by moving the secondary SDLA lever left or right.

NOTE: Pressure build-up in the attachment hose and the power unit couplers may occur, causing difficult installation of hoses. If hoses do not easily connect, try one or both of the following steps:

1. To release the pressure from power unit couplers, turn off engine and move the secondary lever of the SDLA right and left to release pressure in the power unit's hydraulic circuit.
2. To release pressure in the attachment hose, loosen one of the hose ends and retighten when pressure is released.

### WARNING



Hydraulic fluid is under high pressure and can penetrate skin, causing injury. Keep hands, face, and body away from pinholes or nozzles that eject hydraulic fluid under high pressure.

# GENERAL OPERATION

## Weight Transfer

The weight transfer system transfers weight from the attachment to the front wheels of the power unit when the front hitch is in float or assists in lifting the attachment. The operator can select different weight transfer rates using the weight transfer select lever.

To set the weight transfer, raise the front hitch to its maximum height and move the weight transfer select lever to the desired position.

Selecting the proper amount of weight to transfer depends on attachments, ground conditions and operator preference. A lightweight attachment (e.g. KA160 power blower) will not go down with full weight transfer on. With full weight transfer on, and mowing in the float position, the mower may not come down quickly enough when going through uneven terrain. Power unit speed or weight transfer rate must be reduced.

## High/Low Range

### ⚠ CAUTION

Never shift while under load, while moving, or while on a slope. Always ensure the shift lever is secured in the lock position at the end of each shift stroke. Always install the ball pin to prevent the shift lever from being accidentally moved to the neutral position.

Always use low range when operating on slopes of greater than 15 degrees.

Low range is recommended for most pulling, pushing, and slow travel. High range is ideal for transport and light duty tasks.

1. Park the power unit on level ground and engage the parking brake.
2. Move the shift lever to the desired range position.



### Attention

Occasionally the engagement of the transaxle gears is prevented by misalignment. Moving the steering wheel slightly to the right or left will move the gears enough to complete the engagement.

## Turning Radius

The 4500 has three mounting positions for the steering cylinder that determine the power unit's turning radius.

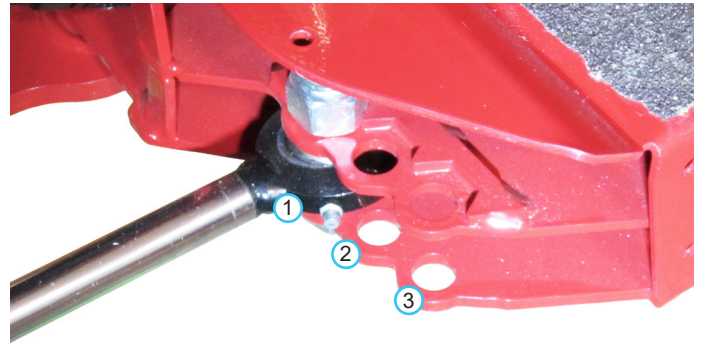

1. **Standard position:** this position is the standard position and enables the tightest turning radius.
2. **Dual wheel position:** The steering cylinder must be installed in this position when operating with dual wheels. The resulting turning radius will be larger than position number 1.
3. **Cab and Versa-loader position:** The steering cylinder must be installed in this position when the cab is installed or when operating the Versa-loader. The resulting turning radius will be larger than position number 2.

# GENERAL OPERATION

## Roll-Over Protection System

### **⚠ WARNING**

Keep the ROPS locked in the upright position and the seat belt securely fastened during operation. Failure to do so could result in serious injury or loss of life.

The 4500 is equipped with a fold down ROPS that allows the power unit to access areas of low overhead clearance. Lower the roll bar only when absolutely necessary and raise the roll bar to the upright position as soon as clearance allows.

### **⚠ WARNING**

Do not wear a seat belt when the roll bar has been lowered to the down position.

To lower the roll bar:

1. Remove the pins from the right and left hinge plates (1).
2. Fold the roll bar down and install the pins in the hinge plates (2) to lock in place.



1. Locked Upright                      2. Locked Folded Down

To raise the roll bar:

1. Remove the pins from the right and left hinge plates (2).
2. Raise the roll bar to the upright position and install the pins in the hinge plates (1) to lock in place.

## 3 Point Hitch (Optional Accessory)

Some light and medium duty implements (non-PTO powered) can be used on the rear of a 3 point hitch equipped power unit.

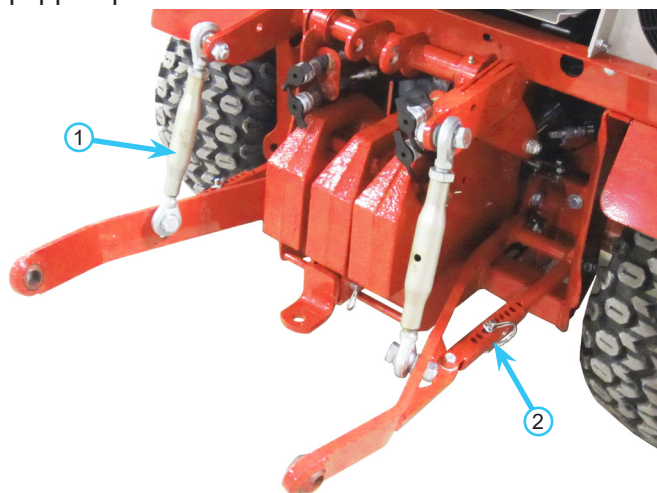

1. Lift Link                                      2. Stabilizing Link

The 3 point hitch is equipped with adjustable lift links (1) to control the individual draw bars. The stabilizing links (2) can be allowed to swing freely or can be locked at a desired position.

The 3 point hitch is equipped with three control handles. The inside handle raises and lowers the draw bar. The middle handle controls the left rear set of hydraulic quick couplers. The outside handle controls the right rear set of hydraulic quick couplers.

## 12 Volt 4-Pin Auxiliary Outlets (Optional Accessory)

Certain attachments require a 12 volt auxiliary outlet. Plug the attachment's 12 volt power cord into the 12 volt 4-pin outlet. The actions of the front 12 volt outlet are controlled by an on/off switch and two momentary on buttons on the SDLA handle. The actions of the rear 12 volt outlet are controlled by an on/off switch and a momentary on/off/on switch on the panel behind the SDLA control. The momentary buttons or switch are used for controlling movement that is only used for a brief time. The on/off switches are used to activate equipment or select different functions.

# GENERAL OPERATION

## Directional/Hazard Flasher Operation (Optional Accessory)

The directional signal / hazard flasher lights are mounted on adjustable arms. They can be positioned with the arms up for standard use, or the arms can be rotated down for use on power units equipped with dual wheels.

To change the light position:

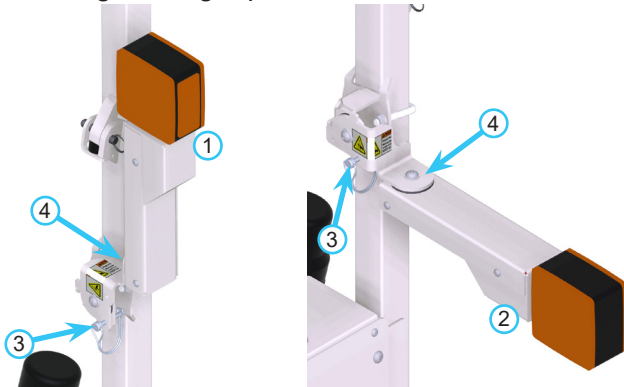

1. Standard Position
2. Dual Wheel Position
3. Lock Pin
4. Pivot Friction Washer

1. Remove the lock pin (3).
5. Move the arm to the desired position.
6. Lock arm in place with the pin.

The light arm is mounted to the pivot bracket using a friction washer that allows the light to pivot forward or backward when it contacts an object (4).

If the light arm gets knocked out of position, manually move the arm back into alignment.

## Suspension Seat Weight Adjustment (Optional 70.4111 Suspension Seat Kit)

The optional suspension seat can be adjusted for the operator's weight.

1. Park the power unit on a level surface.
2. Engage the parking brake.
3. With the operator sitting on the seat, turn the knob (A) on the front of the seat clockwise to increase the amount of suspension for a heavier operator. Turn the knob on the front of the seat counterclockwise to reduce the amount of suspension for a lighter operator. Adjust the seat until a comfortable amount of suspension is found.

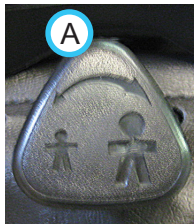

## Operating On Slopes

### **WARNING**

**AVOID PERSONAL INJURY!**

- Operation on slopes decreases power unit stability and increases the potential for unexpected difficulties. Only experienced operators should operate the power unit on slopes and extra caution should be exercised.
- Use low range when operating on slopes greater than 15 degrees.
- Never shift between high and low range while on a slope. Always move the machine to level ground and place the selector lever in park before shifting range.
- Avoid uneven, loose, or wet terrain.
- Stay clear of drop-offs, holes, ditches, rocks, or objects that could cause a sudden and/or unexpected force on the power unit.
- Make slow and cautious starts, stops, and turns.
- Do not exceed the maximum degree of operation. Refer to illustrations.
- Turn downhill when possible and/or reduce the degree of turns.
- Assure a sufficient supply of fuel for continuous operation. A minimum of one-half tank of fuel is recommended.
- To prevent fuel spillage, do not remove the fuel tank cap while power unit is on a slope.
- Failure to follow items listed or to use common sense while operating on slopes can result in injury or death. Always operate on slopes with caution.

### **CAUTION**

Maximum angle of operation for the engine in the 4500P power unit\*.

- Kawasaki FD851D: 30° continuous
- \*Attachments, accessories, and tire configuration may reduce the 4500 power unit's maximum angle of operation. Refer to applicable operator's manuals for maximum angle of operation of the equipment.

Maintain sufficient fuel in tank to ensure continuous operation.

Cease operation if power unit stability is questionable, or if the operator is uncomfortable or unsure of continuing safely.

Attachments can affect the stability of the power unit.

# GENERAL OPERATION

Each attachment will affect the power unit differently. Increase the amount of weight being transferred to the power unit from the attachment while operating on slopes. Refer to Weight Transfer section.

Always operate carefully and in a manner that does not compromise safety.

Always keep the roll bar in the upright, locked position and fasten yourself securely with the seat belt!

Refer to following illustrations for power unit capability with different equipment options.

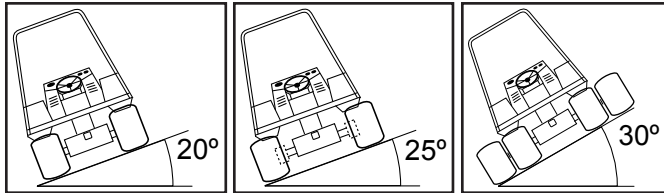

Single Tires      3" Wheel Extensions      Dual Wheels

Model	Single Tires	Wheel Extensions	Dual Wheels
	Any Direction	Any Direction	Any Direction
4500	20°	25°	30°

**Attention**

Some attachments or accessories have further limitations on maximum angle of operation. Refer to individual attachment operator's manuals for limitations.

## 70.4140 Slope Gauge Settings & Operation

**⚠ WARNING**

Do not attempt to enter or use the options menu while driving the power unit. Park the power unit in a safe location and set the parking brake before entering the menu to make changes.

Always make sure the slope gauge is calibrated correctly and the slope limit set-points are set to match the power unit configuration prior to operating the power unit.

Never set the slope limit set-points for the audible or visual alerts to a higher value than the power unit configuration can safely handle. Refer to the Operating On Slopes section of your power unit operator's manual and the safety section of any attachments to determine the correct slope limit.

When changing attachments and/or power unit configuration, always update the audible and visual warning set-points to reflect any changes to the maximum slope rating.

Be aware of whether the audible alarm is turned on (enabled) or muted.

Do not depend solely upon the slope gauge alarm to alert you to dangerous situations. Do not operate on slopes that make you feel uncomfortable.

### Operation

The slope gauge is equipped with a sensor to the left of the display screen.

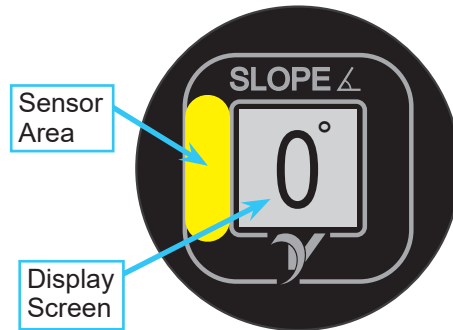

Hold your thumb over the sensor for the required time period to enter the options menu or to make a selection. Follow the instructions on the display screen.



# GENERAL OPERATION

Starting below the sensor area, swipe your thumb up across the sensor to scroll through options such as audible and visual alert set-points or display screen options.

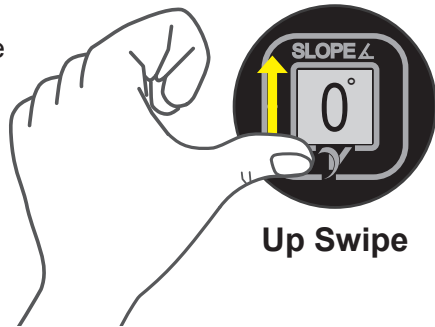

## Tips for Selecting and Swiping

- Do not try to hold (select) or swipe while wearing gloves.
- After making a selection or swiping, move your hand away from the gauge before repeating. Swiping too fast or hovering your hand above the sensor area can cause unintentional input.
- If the sensor is not capturing your swipe movements, try increasing or decreasing the distance from the surface of the gauge, slowing down your motion, or using your entire hand instead of just your thumb.

## Startup

Every time the power unit is started, the slope gauge will display a Ventrac splash screen, followed by the current set-points for the audible and visual alerts. The startup screen will also show whether the audible alarm is turned on (enabled) or muted.

After displaying the startup screen, the slope gauge will return to the last selected display screen and display the current slope.

Alarm Enabled



Alarm Muted



## Menu Options

To calibrate the slope gauge, change audible and visual alert set-points, or to change the display screen, hold your thumb over the slope gauge sensor for 8 seconds to enter the options menu. The option screens will display instructions for making changes to the current feature. Swipe up across the sensor to cycle through the menu screens. Each swipe advances one position to the next menu screen. The dots at the top of the screen allow the user to see where they are at in the menu.

Menu Screen Position (Highlighted)



**Screen 1** allows the user to mute or enable the audible alarm. The screen will display the current state of the alarm. Hold over the sensor for 3 seconds to change the setting.



**Screen 2** changes the audible alarm set-point. Hold over the sensor until the set-point angle begins to flash. Swipe up across the sensor to cycle through the set-point options.



When the desired set-point is reached, hold over the sensor to save the setting.

**Screen 3** changes the visual alarm set-point. Hold over the sensor until the set-point angle begins to flash. Swipe up across the sensor to cycle through the set-point options.



When the desired set-point is reached, hold over the sensor to save the setting.

**Screen 4** calibrates the slope gauge. This zeros out the angle at the current position. Refer to the slope gauge calibration section for calibration instructions.

**Screen 5** changes the screen display. There are five screen display options from which the operator can choose to display during operation. Hold over the sensor until the factory default screen is displayed. Swipe up to cycle through the display screen options.

**Display screen 1** is the factory default screen and it displays the total slope angle in degrees.

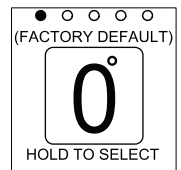

**Display screen 2** displays the total slope angle in degrees along with the percentage of slope.

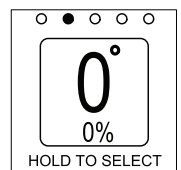

# GENERAL OPERATION

**Display screen 3** displays the total slope angle in degrees along with a visual horizon and roll indicator.

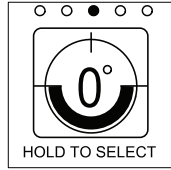

**Display screen 4** displays the total slope angle in degrees along with independent front-to-back angle and side-to-side angle.

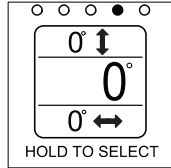

**Display screen 5** displays the total slope angle in degrees along with independent front-to-back angle and side-to-side angle with position indicators.

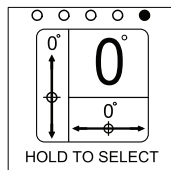

When the desired display screen is reached, hold over the sensor to select and save. The slope gauge will remember the selected screen when the power unit is shut off and will display the selected screen when the power unit is restarted.

**Screen 6** resets the slope gauge back to factory default settings. The audible alarm will be turned on, and the audible and visual set-points will be restored to 20 degrees. The slope gauge will need to be re-calibrated before operation of power unit. Hold over the sensor area until the screen changes to show the default audible and visual alarm settings. Hold over the sensor area again until the screen changes to notify you that the reset was successful.

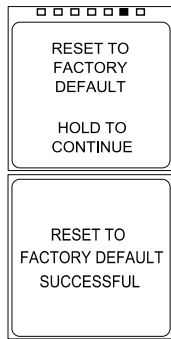

**Screen 7** exits the options menu. Hold over the sensor area to exit and return to the display screen.



## Audible & Visual Alerts (70.4140 Gauge)

**⚠ WARNING**

Never set the slope limit set-points for the audible or visual alerts to a higher value than the power unit configuration can safely handle. Refer to the Operating On Slopes section of your power unit operator's manual and the safety section of any attachments to determine the correct slope limit.

Before operation, determine the maximum slope rating for the power unit and attachment configuration. Change the set-points for the audible and visual alerts to match the maximum slope rating. If the power unit is operated on a slope angle greater than the set angle, the audible alarm will sound (unless muted) and the display screen will flash a visual warning to alert the operator. If this occurs, slowly and carefully move the power unit off the slope.

## 70.4140 Slope Gauge Calibration

**⚠ WARNING**

Power unit must be parked on level, horizontal ground in order to be calibrated correctly. Always check to make sure the gauge is calibrated correctly prior to operating the power unit.

1. Park the power unit on a flat, level surface.
2. Shut off the power unit engine and lower any attachments to the ground.
3. Turn the ignition key to the run position.
4. Enter the options menu and scroll to the calibration screen.
5. Hold your thumb over the sensor until the screen displays a warning message, then remove your thumb. If the requirements in the warning message are met, hold your thumb over the sensor again to perform calibration.
6. When the screen changes to say calibration successful, remove your thumb from the sensor. The gauge will automatically return to the selected display screen.



# GENERAL OPERATION

---

## Operation in Water, Mud, Snow, or Ice

### **WARNING**

Operation in water, mud, snow, or ice decreases power unit traction and increases the potential for unexpected difficulties or loss of control. Reduce speed and exercise caution.

### **WARNING**

Operation on frozen bodies of water can be dangerous. The machine could fall through the ice and cause the operator to drown. Never operate on ice unless you have verified the thickness of the ice and that the travel path is safe.

### **CAUTION**

Operation in water may cause damage to the hydraulic system, axles, or other parts. If the water level reaches the tire rim, the water is too deep.

## Towing Or Pushing The Power Unit



### **Attention**

**Avoid damage to your power unit! Before towing, read and understand the information below. Severe damage will occur to unit if proper towing procedure is not followed.**

### **CAUTION**

Failure to place the transaxles in neutral when towing or pushing the power unit may result in damage to the power unit drivetrain.

If the power unit needs to be moved without the engine running, it is important to remember to place the transaxles in neutral by shifting the high/low range shift handle to the middle of the shift stroke. With the transaxles in neutral and the parking brake disengaged, the power unit can freewheel. Use extreme caution when towing or pushing the power unit; steering may not function. Do not exceed 5 mph (8 km/h).

# SERVICE

## ⚠ WARNING

Always set the parking brake, shut off power unit engine, remove the ignition key, and ensure all moving parts have come to a complete stop before inspecting components or attempting any repair or adjustment.



## Attention

Ventrac recommends that service be performed by a qualified technician. If you are unsure how to perform the service procedure(s), contact your Ventrac dealer.



## Attention

If any component requires replacement, use only original Ventrac replacement parts.

## Service And General Maintenance

Proper and timely service of this power unit is critical to keep the power unit in a safe and reliable operating condition. Follow the maintenance schedule at the end of the service section. For convenience, a frequent service guide decal and a quick reference chart decal have been placed on the power unit under the hood.

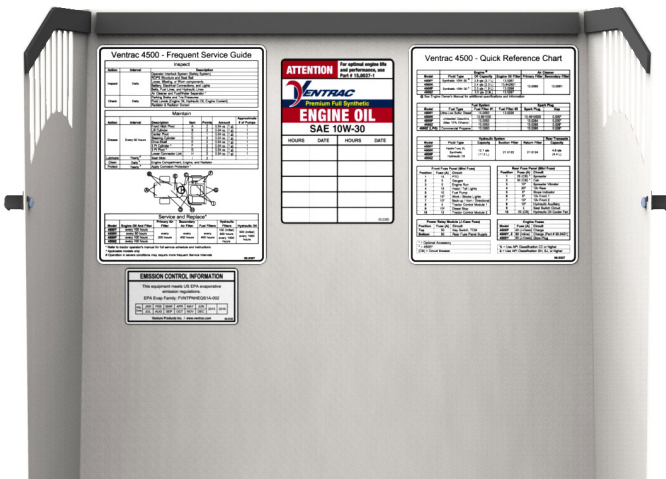

## Cleaning And Appearance Care

For best results, and to maintain the finish of the power unit, clean or wash the power unit to remove accumulated clippings, leaves, dirt, gravel, and salt deposits when the job is finished.



## Attention

To maintain the finish of the power unit, thoroughly wash the equipment after each use to remove any corrosive agents (e.g. salt). Failure to clean the equipment may result in corrosion of (including but not limited to) steel, aluminum, and electrical components. Equipment that will experience repeated exposure to corrosive agents should be pretreated with a corrosion preventative.

## ⚠ CAUTION

If the engine has been running, it must be allowed to cool in order to prevent damage to the block and exhaust manifold.

Do not direct high pressure water at the engine, air cleaner, muffler, radiator, hydraulic oil cooler, or any electrical components.

Allow the power unit and all components to cool before washing. Refer to the specific service sections for proper cleaning techniques for the engine, radiator, and hydraulic oil cooler. Use mild soap and water to clean the power unit. Harsh chemical cleaners could cause damage to the finish or components.

It is necessary to periodically remove the lower rear frame cover and blow out or wash out any accumulated debris.

After cleaning, use touch up paint to repair scrapes.

# SERVICE

## Service Access Points

Throughout the service section, different access points are referred to. The following list and images identify shields and covers that may need to be removed or opened during service.



- 1. Engine Hood
- 2. Pump Cover
- 3. Right Pump Access Cover
- 4. Right Engine Cover



- 5. Left Engine Cover
- 6. Hydraulic Filter Access Cover
- 7. Seat



8. Lower Rear Frame Cover

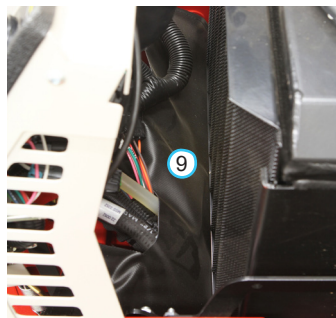

9. Debris Barrier

## Lubrication Locations

Lubrication is required at the following locations. Refer to the maintenance schedule for service intervals and amount of grease.

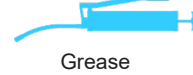

Grease



Silicon Based Spray Lube

Refer to Specification section for grease type.

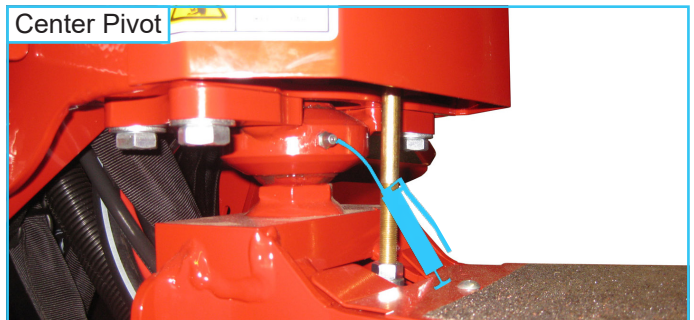
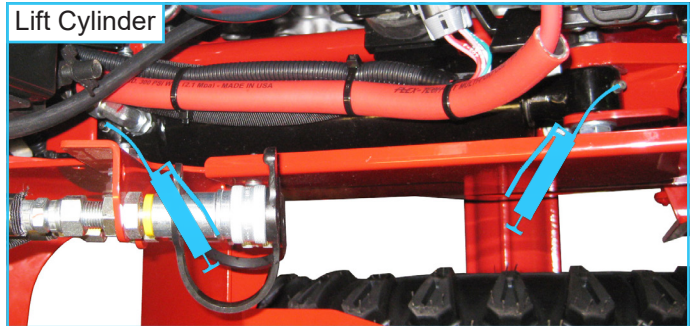
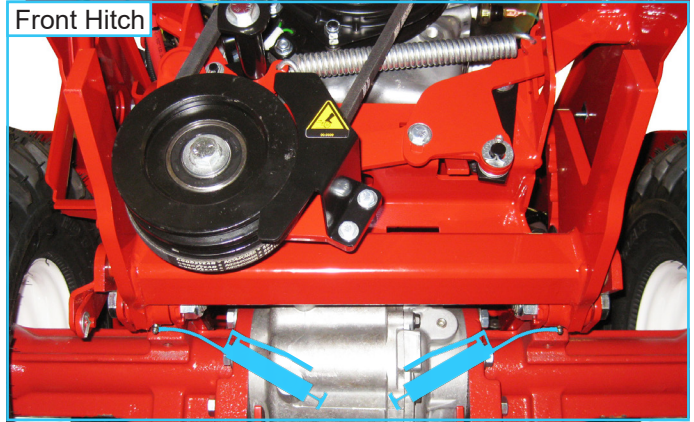
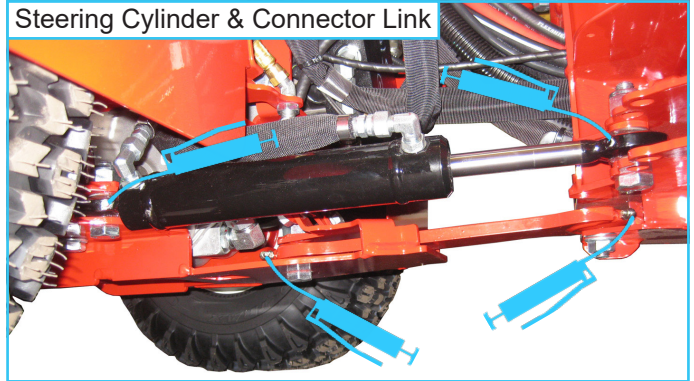

# SERVICE

## Lubrication Locations (Cont.)

Drive Shaft

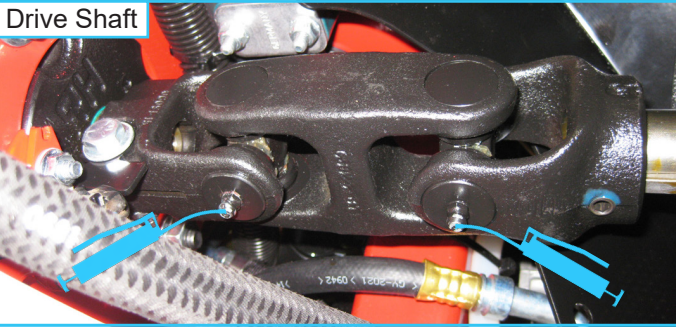

The front fitting of the drive shaft can be reached under the radiator, from the right side of the power unit, using a grease gun with a 13" (33 cm) or longer rubber hose. Remove the right engine cover and rotate the drive shaft so the grease fitting is pointed directly toward the right side of the power unit. Insert the hose from the right side, under the hydraulic couplers and radiator, directly in line with the grease fitting. Push the hose onto the grease fitting and hold in place while greasing.

The rear fitting can be reached in back of the radiator, after pulling back the canvas debris barrier.

Seat Slide

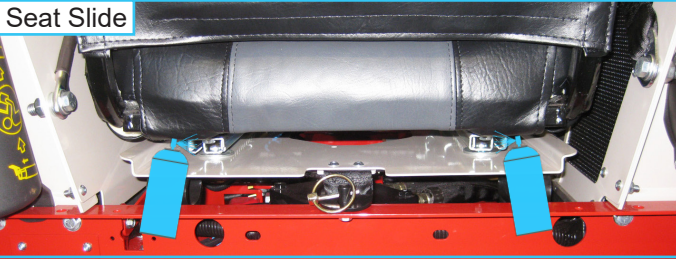

Optional 3-Point Hitch

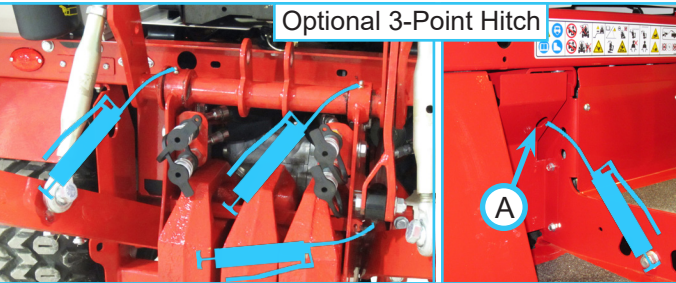

The front grease fitting on the 3 point cylinder can be greased through an access hole (A) in the right foot platform panel.

## Checking Hydraulic Oil Level

Check the hydraulic oil level when the hydraulic system is cold, prior to operating the power unit. If the hydraulic system is warm, allow one hour for the hydraulic system to cool before checking the oil level. Checking the oil level when the hydraulic system is warm will produce an inaccurate oil level reading.



### Attention

After connecting a new attachment or kit that runs off the power unit's hydraulic system, run the attachment through a complete cycle, then stop and check the hydraulic oil level.

1. Park the power unit on a level surface and adjust the steering to aim the power unit straight ahead.
2. Fully raise the front hitch and lower the 3-point hitch (if equipped).
3. Engage the parking brake and shut off the engine.
4. Remove the key from the ignition switch and allow time for the hydraulic system to cool.
5. The hydraulic oil tank (A) is located under the hood and dash.
6. Check the oil level in the plastic sight tube (B) next to the hydraulic oil tank. The oil level should be within the proper range indicated by the oil level decal on the hydraulic oil tank.
7. If the hydraulic oil level is below the low mark on the decal, add HydroTorq XL synthetic hydraulic oil until the proper level is reached.

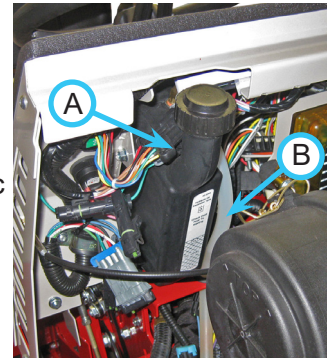

# SERVICE

## Checking Rear Transaxle Oil

Check the rear transaxle oil level when the oil is cold, prior to operating the power unit.

1. Park the power unit on a level surface.
2. Engage the parking brake and shut off the engine.
3. Remove the rear weights from the hitch bar (if equipped).
4. Remove the oil fill plug (A) from the transaxle and check to see if the oil level is even with the bottom of the oil fill hole.
5. If the oil level is low, add HydroTorq XL synthetic hydraulic oil until level with the bottom of the oil fill hole.
6. Reinstall the oil fill plug.
7. Reinstall the rear weights (if equipped).

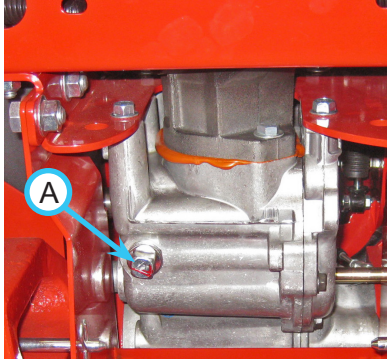

## Changing Hydraulic Oil Filters

1. Park the power unit on a level surface.
2. Engage the parking brake and shut off the engine.
3. Remove the key from the ignition switch and allow time for the hydraulic system to cool.

### ⚠ WARNING

Hot oil can cause severe burns. Allow the oil temperature to drop from hot to warm before changing the oil filters.

4. Remove the hydraulic filter access cover.
5. Clean the hydraulic filters, filter heads, and the area around the filters.
6. Place a drain pan (minimum 4 quart / 3.78 liter) under the hydraulic filters.
7. Use a strap type filter wrench to unscrew both the large (A) and small (B) hydraulic filters from the filter heads and allow the oil to drain into the pan.
8. Ensure the filter mounting surfaces are clean.
9. Apply a thin film of clean oil to the gasket of the new large filter and screw the filter onto the filter head until the gasket makes

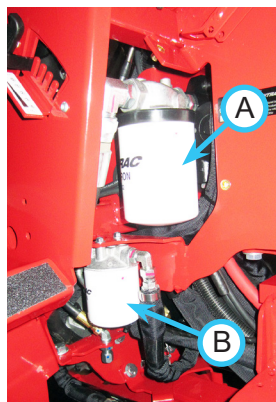

contact with the mounting surface. Tighten the filter an additional 3/4 of a turn (may require using a strap type filter wrench).

10. Apply a thin film of clean oil to the gasket of the new small filter and screw the filter onto the filter head until the gasket makes contact with the mounting surface. Tighten the filter an additional 1 turn (may require using a strap type filter wrench).
11. Clean up any spilled oil and dispose of oil and filters in accordance with local laws.

### ⚠ CAUTION

Oil is hazardous to the environment. Drain oil into an approved container and dispose of used oil in accordance with local laws.

12. If hydraulic oil is being changed at the same time as the filters, skip the remaining steps and proceed to Changing Hydraulic Oil section.
13. Add HydroTorq XL synthetic hydraulic oil to the hydraulic oil tank until the oil level in the plastic sight tube is within the proper range indicated by the oil level decal.
14. Start the power unit and let it run at low idle engine speed for a few minutes. Turn the steering wheel to the left and right a couple of times to purge any trapped air out of the hydraulic system.
15. Shut off the power unit engine and allow the power unit to sit for a minimum of 5 minutes.
16. Check the hydraulic oil level. Refer to the manual section for checking hydraulic oil level.
17. Inspect both hydraulic filters for signs of leakage. If any leaks are evident, the filter may need tightened further, or the filter may need to be removed, the gasket and filter mount cleaned, and the filter reinstalled following the procedures for changing the filter.
18. Reinstall the hydraulic filter access cover.

# SERVICE

## Changing Hydraulic Oil

1. Wash the underside of both the front and rear transaxles thoroughly.
2. Park the power unit on a level surface and adjust the steering to aim the power unit straight ahead.
3. Fully raise the front hitch and lower the 3-point hitch (if equipped).
4. Engage the parking brake and shut off the engine.
5. Remove the key from the ignition switch and allow time for the hydraulic system to cool.

### **⚠ WARNING**

Hot oil can cause severe burns. Allow the oil temperature to drop from hot to warm before draining the hydraulic oil.

6. Place a drain pan (minimum 14 quart / 13.5 liter) under the front transaxle.
7. Remove the drain plug (A) from the front transaxle and allow the hydraulic oil to drain from the system. Loosen the cap on the hydraulic oil tank to allow venting.

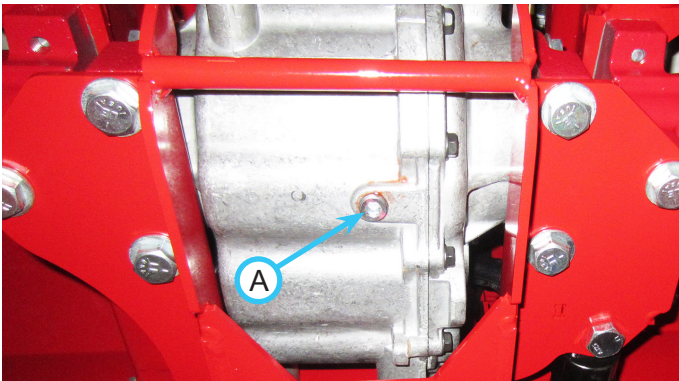

8. If equipped with a pipe plug, clean the drain plug and apply pipe sealant to the threads, making sure to leave the last two threads bare to prevent thread sealant from contaminating the hydraulic fluid. Reinstall the plug into the front transaxle and tighten 1 - 1-1/2 turns past finger tight (approximately 35-40 ft-lbs / 48-54 Nm of torque) for pipe plugs.
9. If equipped with an O-ring plug, reinstall the plug into the front transaxle and torque to 25-29 ft-lbs (34-39 Nm).

### **⚠ CAUTION**

Do not over tighten the transaxle plug. Over-tightening can cause the transaxle case to crack.

10. Clean up any spilled oil and dispose of oil in accordance with local laws.

### **⚠ CAUTION**

Oil is hazardous to the environment. Drain oil into an approved container and dispose of used oil in accordance with local laws.

11. If the hydraulic filters are being changed with the oil, proceed to Changing Hydraulic Oil Filters section before completing the remaining steps in this section.
12. Add HydroTorq XL synthetic hydraulic oil to the hydraulic oil tank until the oil level in the plastic sight tube is within the proper range indicated by the oil level decal.
13. Start the power unit and let it run at low idle engine speed for a few minutes. Turn the steering wheel to the left and right a couple of times to purge any trapped air out of the hydraulic system.
14. Shut off the power unit engine and allow the power unit to sit for a minimum of 5 minutes.
15. Check the hydraulic oil level. Refer to the manual section for checking hydraulic oil level.

# SERVICE

## Changing Rear Transaxle Differential Oil

1. Remove the rear weights from the hitch bar (if equipped).
2. Place a drain pan (minimum 6 quart / 5.5 liter) under the rear transaxle.

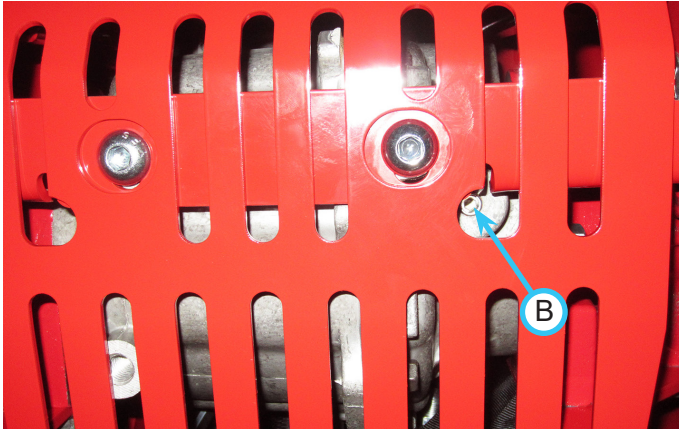

3. Remove the drain plug (B) from the rear transaxle and allow the hydraulic oil to drain from the system. Remove the oil fill plug (C) from the rear transaxle to allow venting. NOTE: on some power units, it may be necessary to remove the rear transaxle skid plate to access the drain plug.
4. If equipped with a pipe plug, clean the drain plug and apply pipe sealant to the threads, making sure to leave the last two threads bare to prevent thread sealant from contaminating the hydraulic fluid. Reinstall the plug into the front transaxle and tighten 1 - 1-1/2 turns past finger tight (approximately 35-40 ft-lbs / 48-54 Nm of torque) for pipe plugs.
5. If equipped with an O-ring plug, reinstall the plug into the front transaxle and torque to 25-29 ft-lbs (34-39 Nm).

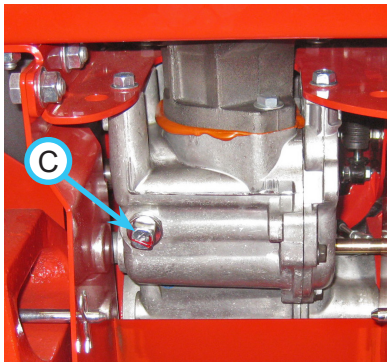

### **CAUTION**

Do not over tighten the transaxle plug. Over-tightening can cause the transaxle case to crack.

6. Add HydroTorq XL synthetic hydraulic oil (approximately 4 qt / 3.8 L) to the fill port in the rear transaxle until level with the bottom of the oil fill hole.
7. If equipped with a pipe plug, clean the oil fill plug and apply pipe sealant to the threads, making

sure to leave the last two threads bare to prevent thread sealant from contaminating the hydraulic fluid. Reinstall the plug into the rear transaxle and tighten 1 - 1-1/2 turns past finger tight (approximately 35-40 ft-lbs / 48-54 Nm of torque).

8. If equipped with an O-ring fill plug, reinstall the plug into the rear transaxle and torque to 25-29 ft-lbs (34-39 Nm).
9. Clean up any spilled oil and dispose of oil in accordance with local laws.

### **CAUTION**

Oil is hazardous to the environment. Drain oil into an approved container and dispose of used oil in accordance with local laws.

10. If the rear transaxle skid plate was removed to access the drain plug, reinstall the skid plate.
11. Reinstall the rear weights (if equipped).

## Servicing Closed Loop Hydrostatic Drive Circuit



### **Attention**

Service or repair of the closed loop drive circuit must be performed by an authorized Ventrac dealer. If any part of the closed loop hydrostatic drive circuit (pump, front drive motor, rear drive motor, or any of the three 1/2" hydraulic lines connecting them together) is serviced or replaced, the Ventrac closed loop drive circuit filtration procedure must be performed. This procedure requires a special Ventrac remote filtering tool and must be performed by a Ventrac authorized technician.

## Servicing Hydraulic Oil Cooler

1. Brush dirt and debris from the oil cooler screen in the right fender.
2. With the ignition key turned to the run position, flip the oil cooler fan switch from "auto" to "reverse" operation to blow dust off the oil cooler fins.
3. Place the fan switch back in the "auto" position.

## Checking Engine RPM

Check engine RPM when engine is warmed up and not under load. Observe tachometer:

- Low idle speed = 1550 ±50 RPM
- High idle speed = 3600 ±50 RPM

If engine RPM is incorrect, contact your local Ventrac dealer.

# SERVICE

## Checking Engine Oil Level



### Attention

Avoid Engine Damage!

Failure to check the oil level regularly could lead to serious damage to your engine, if the engine is run with an incorrect oil level.

- Check the engine oil level with the power unit sitting on a level surface and with the engine shut off and the oil cold.
- Keep oil level between the **FULL** and **ADD** marks.
- Do not add oil with the engine running.

1. Park the power unit on a level surface.
2. Engage the parking brake and shut off the engine.
3. Remove the key from the ignition switch and allow the engine and oil to cool.
4. Open the engine hood to access the engine compartment.
5. Remove the oil dipstick (A) from the engine and wipe with a clean cloth.

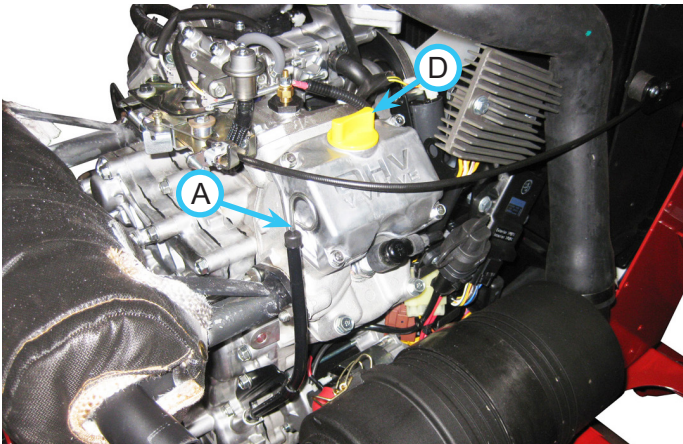

6. Insert the dipstick back into the engine and remove again.
7. Check the oil level. The level should be between the Full (B) and Add (C) marks on the dipstick.



8. If the oil level is low, remove the oil fill cap (D) and add small amounts of engine oil to bring the oil level no higher than the Full (B) level on the dipstick.
9. If oil level is above the Full (B) mark, drain some engine oil to achieve the proper level.
10. Reinstall the dipstick and the oil fill cap and close the engine hood.

## Changing Engine Oil And Filter



### CAUTION

Contact with engine oil can irritate your skin. Wear protective gloves when working with engine oil. If you come in contact with engine oil, wash it off immediately.



### CAUTION

Oil is hazardous to the environment. Drain engine oil into an approved container. Dispose of used engine oil in accordance with local laws.

1. Start the power unit engine and allow it to run until the engine reaches operating temperature.
2. Park the power unit on a level surface.
3. Engage the parking brake and shut off the engine.
4. Remove the key from the ignition switch.
5. Open the engine hood to access the engine compartment.
6. Remove the right engine cover to provide access to the oil filter.
7. Place a drain pan underneath the oil drain (A) located in front of the hydraulic oil filters on the left side of the power unit.

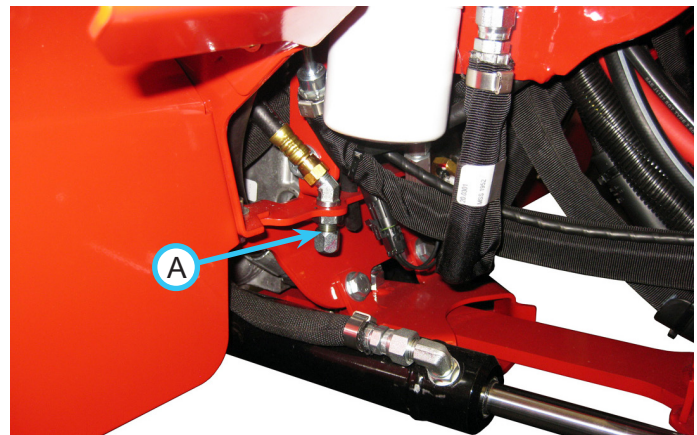

### WARNING

Hot engine oil can cause severe burns. Allow the engine temperature to drop from hot to warm before draining the oil.

8. Remove the drain cap from the oil drain and drain into the pan while the oil is warm.



# SERVICE

- Remove the oil filter (B) located on the side of the engine. Turn the filter counterclockwise to remove.

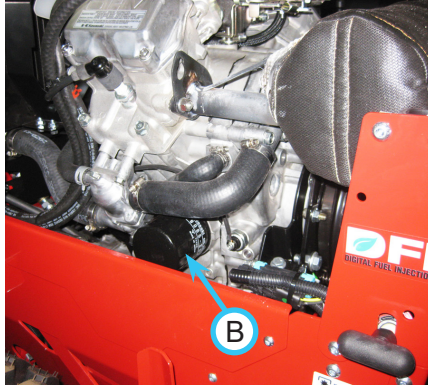

- Wipe the filter mounting surface with a clean cloth.
- Apply a thin film of clean oil to the gasket of the new oil filter.
- Install the new filter turning it clockwise until the gasket makes contact with the mounting surface. Tighten the filter 1/2 to 3/4 turn more by hand.
- Install the drain cap onto the oil drain. DO NOT over-tighten.
- Remove the oil fill cap.
- Add oil to the engine. (Refer to Engine Owner's Manual for proper oil specifications and capacity.)

### Attention: Engine Oil Recommendation

For optimal engine life and performance, use Ventrac Full Synthetic Engine Oil.  
Part # 15.0037-1



- Install the oil fill cap and wipe up any oils spills.
- Start the engine and run at slow idle for approximately 2 to 3 minutes.
- Shut off the engine and remove the ignition key.
- Check for oil leaks around the oil filter.
- Check the engine oil level after allowing the engine to cool for approximately 2 minutes. Add oil, if necessary.
- Reinstall right engine cover.

## Changing Air Filter Elements

### CAUTION

When the air filter elements are removed, an opening is created to the internal parts of the engine.

Be sure nothing falls into the canister that could make its way into the engine. Have the new filter elements ready to install immediately after removing the old filter elements.



### Attention

Avoid damage to your engine!

Improper service to the engine air filter can result in severe engine damage.

- Inspect filter daily in extreme heat, dust, or other severe conditions.
- Never run the engine without a proper air filter installed.
- Never wash or clean the paper filter element.

- Park the power unit on a level surface.
- Engage the parking brake and shut off the engine.
- Remove the key from the ignition switch and allow the engine to cool.
- Locate the engine air cleaner assembly (A).
- Release both latches (B) on the filter assembly and unhook the latches from the filter housing.

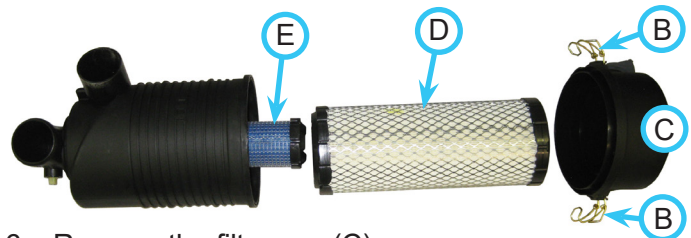

- Remove the filter cap (C).
- Remove and discard the primary air filter element (D).
- If the safety air filter element (E) is scheduled for replacement, remove and discard the safety air filter element.
- Install the new air filter element(s).
- Install the filter cap and fasten both latches.

# SERVICE

## Filling The Fuel Tank

### **⚠ DANGER**

Fuel is flammable and/or explosive. Follow all safety instructions in the Fuel Safety section of this manual and in the engine operator's manual.

### **⚠ WARNING**

Long term exposure to fuel vapors can cause serious injury or illness. Avoid prolonged breathing of fuel vapors.

If fuel is spilled on skin or clothing, change clothing and wash affected skin immediately.

### **⚠ CAUTION**

Avoid damage to your engine!

Only use fuel that meets the specifications required for your engine. Refer to the engine operator's manual for the proper grade and specifications of fuel for your engine.

1. Park the power unit on a level surface.
2. Engage the parking brake and shut off the engine.
3. Remove the key from the ignition switch and allow the engine to cool.
4. The fuel tank cap is located on top of the left rear fender. Wipe any dust and dirt off the fuel cap to prevent dirt from falling into the fuel tank, and remove the fuel cap.
5. Add fuel to the tank until the fuel level reaches the bottom of the fuel neck\*. Do not overfill by filling the fuel neck, as this may cause engine flooding, fuel leakage from the tank, and/or damage to the emissions control system. Keep the fuel nozzle in contact with the rim of the fuel neck until fueling is completed.
6. Replace the fuel cap and tighten until it clicks.
7. Wipe up any fuels spills and allow fuel vapors to dissipate before starting the engine.

## Changing The In-line Fuel Filter

1. Park the power unit on a level surface.
2. Engage the parking brake and shut off the engine.
3. Remove the key from the ignition switch.
4. Turn the fuel shut-off valve to the Off position.
5. Remove the lower rear frame cover.
6. Loosen the hose clamps and remove the fuel filter (A).
7. Install the new fuel filter with the flow arrow pointing toward the engine and fasten securely with the hose clamps.
8. Turn the fuel shut-off valve to the On position.
9. Inspect fuel filter hose connections for leaks.
10. Reinstall the lower rear frame cover.

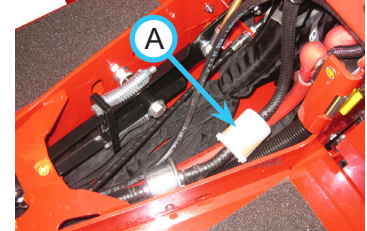

## Priming The Fuel System

1. Turn the ignition key to the On position for about 30 seconds. The operator should hear the fuel pump operating.
2. Start the power unit. Repeat step 1 if necessary.

## Cleaning Engine Compartment & Engine

Clean the engine compartment and engine daily or prior to each use, to reduce the risk of engine overheating or ignition of accumulated debris.

1. Park the power unit on a level surface.
2. Engage the parking brake and shut off the engine.
3. Remove the key from the ignition switch and allow the engine to cool.
4. Open the engine hood and remove the left and right engine covers to access the engine compartment.
5. Remove accumulated debris and dust from the engine compartment and engine.
6. Refer also to Cleaning The Radiator And Screen section of this manual.

\*If power unit will not be used after filling fuel tank, only fill the tank to within 1" (25 mm) of the bottom of the fuel neck to allow room for fuel expansion from temperature changes. Failure to do so may cause engine flooding, fuel leakage from the tank, and/or damage to the emissions control system.

# SERVICE

## Servicing The Cooling System

### **⚠ WARNING**

#### **Avoid Personal Injury!**

If the unit has been running, the radiator and radiator coolant will be hot and can burn skin! Built-up pressure in the radiator can cause an explosive release of coolant if the radiator cap is removed:

- Shut off engine and allow to cool.
- Do not remove the radiator cap unless the radiator and engine are cool enough to touch with bare hands.
- Slowly loosen cap to the first stop to release all the pressure before removing completely.

### **⚠ WARNING**

#### **Avoid Personal Injury!**

Wear personal protective equipment to protect eyes and hands when opening radiator cap to protect against the pressure in the radiator.

If coolant is spilled on skin or clothing, change clothing and wash affected skin immediately.

### **⚠ CAUTION**

Coolant is poisonous to humans and animals and is hazardous to the environment. Drain coolant into an approved container. Dispose of used coolant in accordance with local laws.



### **Attention**

#### **Avoid damage to your engine!**

Using incorrect coolant mixture and/or type can cause engine damage. Use only a mixture of 50% distilled water and 50% ethylene glycol antifreeze. Recommended antifreeze: a low silicate, phosphate free antifreeze (ethylene glycol) containing supplemental coolant additives (SCA's) to inhibit corrosion and rust.

Dye Color does not determine the antifreeze properties; ethylene glycol antifreeze of different colors can be mixed.

## Checking The Cooling System

1. Park the power unit on a level surface.
2. Engage the parking brake and shut off the engine.
3. Remove the key from the ignition switch and allow the engine to cool.
4. Open the engine hood to access the engine compartment.
5. Check the coolant level in the coolant recovery tank (A). When cold, the coolant recovery tank should be approximately half full of coolant.

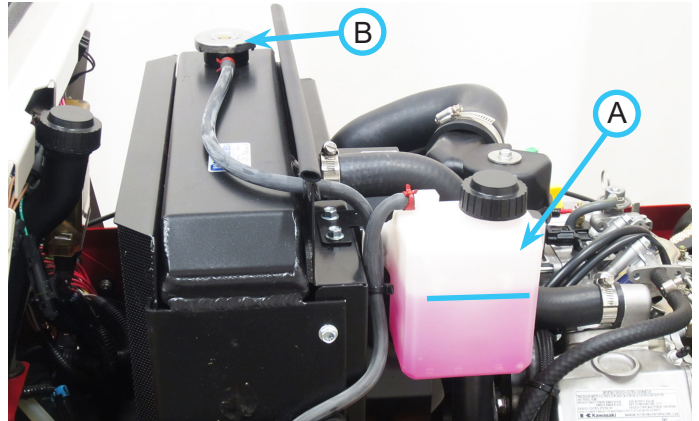

6. If the coolant level is low, add coolant to the tank and reinstall the cap.
7. If the coolant recovery tank is empty, slowly open the radiator cap (B) to the first stop to allow any pressure to release. Press down on the cap slightly and continue to turn counterclockwise to remove the cap from the radiator.
8. Check to ensure the coolant level is up to the bottom of the filler neck.
9. If the coolant level is low, add coolant to the radiator until it reaches the bottom of the filler neck.
10. Install the radiator cap.
11. Inspect the radiator hoses and clamps for leaks and deterioration. Replace as necessary.
12. Close the engine hood.

# SERVICE

## Cleaning The Radiator And Screen

1. Park the power unit on a level surface.
2. Engage the parking brake and shut off the engine.
3. Remove the key from the ignition switch and allow the engine to cool.
4. Open the engine hood to access the engine compartment.
5. Remove the radiator screen (A).
6. Remove debris from the radiator screen using a brush, compressed air, or water.
7. When required, clean debris from the radiator using low pressure compressed air or water.
8. Check radiator fins for damage.
9. Install the radiator screen.
10. Close the engine hood.

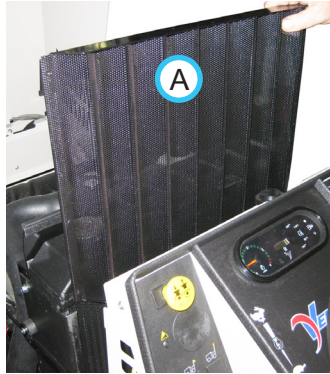

## Draining The Cooling System

### ⚠ CAUTION

Coolant is poisonous to humans and animals and is hazardous to the environment. Drain coolant into an approved container. Dispose of used coolant in accordance with local laws.

1. Park the power unit on a level surface.
2. Engage the parking brake and shut off the engine.
3. Remove the key from the ignition switch and allow the engine to cool.
4. Open the engine hood and remove the right engine cover to access the engine compartment.
5. Slowly open the radiator cap to the first stop to allow pressure to release.
6. Place a drain pan or jug under the right side of the front frame.
7. Install a 7/16" (11 mm) ID hose (A) onto the radiator drain port (B) and route down to the drain pan.
8. Turn the drain valve counterclockwise to open and drain the coolant into the drain pan.

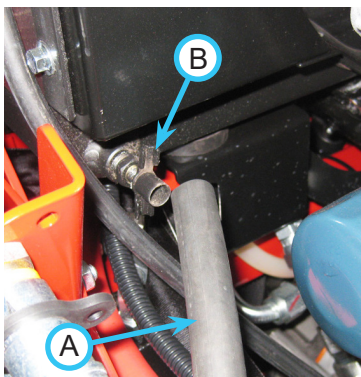

## Flushing The Cooling System

1. Drain the cooling system following the procedures in the previous section.
2. Close the radiator drain valve, leaving the drain hose in place.
3. Add one can of radiator flush to the radiator and fill the radiator with clean water.
4. Install the radiator cap, start the engine, and run until the engine reaches operating temperature (160 - 180 degrees) (71 - 82° C).
5. Shut off the engine and remove the key from the ignition switch.

### ⚠ WARNING

Hot coolant can cause severe burns. Allow the temperature of the radiator to drop from hot to warm before draining the coolant.

6. Carefully drain the cooling system while the coolant is still warm.
7. Allow the engine and radiator to cool completely.

### ⚠ CAUTION

Allow engine and radiator to cool completely. Engine damage could occur if cold water is added to a hot engine.

8. Add clean water to the radiator and allow the water to run through the system. Add more water as needed, until the water flowing from the drain valve is clear and free of sediment.
9. After the water has drained completely, close the radiator drain valve and remove the drain hose.
10. Slowly add the proper coolant (refer to Engine Owner's Manual for the correct type of coolant) to the radiator until the level reaches the bottom of the filler neck. NOTE: residual water may be present in the engine. Adjust the coolant mixture to achieve a 50/50 ratio.
11. Install the radiator cap, start the engine, and run until the engine reaches operating temperature (160 - 180 degrees) (71 - 82° C).
12. Shut off the engine and allow the engine to cool.
13. Recheck the coolant level when the engine is cold. Add additional coolant if necessary.
14. Reinstall the right engine cover and close the engine hood.

# SERVICE

## Servicing The Battery

### **⚠ DANGER**

The battery produces a flammable and explosive gas. The battery may explode.

- Wear eye protection and gloves.
- Do not smoke near the battery.
- Keep arcs, sparks, and open flames away from batteries.
- Do not allow direct metal contact across the battery posts.
- Remove the negative battery cable first when disconnecting the battery.
- Install the negative battery cable last when connecting the battery.

### **⚠ WARNING**

#### **Avoid Personal Injury!**

Battery electrolyte contains sulfuric acid. It is **poisonous** and can cause **severe chemical burns**.

- Wear eye and skin protection.
- Keep skin protected.
- If battery electrolyte is spilled on skin or clothing, change clothing and wash affected skin immediately. Seek medical attention, if necessary.
- If battery electrolyte is splashed in eyes, flush immediately with water for 15-30 minutes and seek immediate medical attention.
- If battery electrolyte is swallowed, get medical attention immediately. Drink large quantities of water, followed by Milk of Magnesia, beaten egg, or vegetable oil. **DO NOT** give fluids that would induce vomiting.

### **⚠ CAUTION**

Batteries contain poisonous and hazardous substances. Dispose of used batteries in accordance with local laws.

## Removing The Battery

1. Park the power unit on a level surface.
2. Engage the parking brake and shut off the engine.
3. Remove the key from the ignition switch.
4. Tilt the seat forward and fasten in place with the seat prop.
5. Remove the left foot platform panel (A).
6. Disconnect the negative (-) battery cable (B).

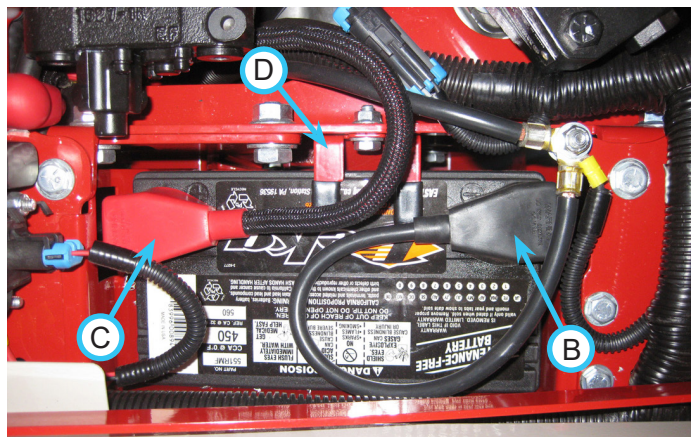
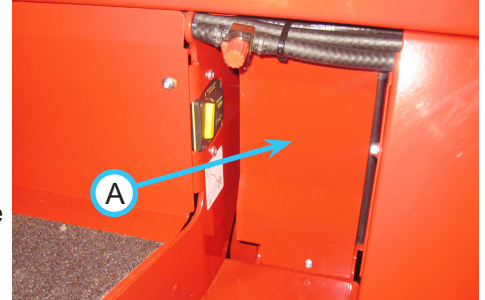

7. Disconnect the positive (+) battery cable (C).
8. Remove the battery retainer (D).
9. Slide the battery out of the battery compartment.

## Installing The Battery

1. Slide the battery into the battery compartment with the negative post to the rear.
2. Install the battery retainer and torque the bolt to 210 in-lbs (24 Nm).
3. Install the left foot platform panel. Torque bolt to 100 in-lbs (11 Nm).
4. Connect the positive battery cable to the positive battery post first.
5. Connect the negative battery cable to the negative battery post last.
6. Apply dielectric grease to the battery terminals to prevent corrosion.
7. Place the covers back over the battery terminals.

# SERVICE

## Cleaning The Battery And Terminals

1. Park the power unit on a level surface.
2. Engage the parking brake and shut off the engine.
3. Remove the key from the ignition switch.
4. Tilt the seat forward and fasten in place with the seat prop.
5. Disconnect and remove the battery.
6. Wash the battery with a solution of four tablespoons of baking soda to 1 gallon (3.8 L) of water. Be careful not to get the soda solution into the cell.
7. Rinse the battery with clean water and dry.
8. Clean the battery posts and battery cable terminals with a wire brush.
9. Install the battery back into the power unit.
10. Apply dielectric grease to the battery terminals to prevent corrosion.
11. Place the covers back over the battery terminals.

## Charging The Battery

### **⚠ DANGER**

Batteries produce explosive gases. Charge the battery in a well ventilated space where the gases produced by charging can dissipate. Do not charge where the battery could be exposed to sparks, open flames, or other sources of ignition.

Never charge a frozen battery, as it may explode. Allow the battery to warm up and inspect for cracks or damage before charging.

To preserve optimum battery performance and life, do not allow the battery to stand in a discharged state for long periods of time. If the battery is not being used, check the battery voltage every 30 days and recharge the battery if the voltage drops to 12.4 volts or lower.

Keep the battery fully charged in cold weather to prevent damage due to freezing.

1. If possible, remove the battery from the power unit before charging.
2. Refer to the battery charger's manual for specific charging instructions.
3. If electrolyte is expelled or excessive gassing occurs, or if the temperature of the battery exceeds 125° F (52° C), charging must be temporarily stopped to permit cooling. After cooling, reduce the charging rate before starting the charger again.

## Jump Starting Procedure

### **⚠ DANGER**

The battery produces a flammable and explosive gas. The battery may explode.

- Wear eye protection and gloves.
- Do not jump start a cold or frozen battery. Allow the battery to warm up and inspect for cracks or damage.
- Do not jump start a cracked or damaged battery.
- Do not attempt to jump start the power unit using a battery of a different voltage.

1. Inspect the discharged battery for terminal corrosion and loose connections. Clean terminals and tighten connections prior to jump starting.
2. Make sure the vehicle used to jump start the power unit has a 12 volt, negative ground, electrical system.
3. Pull the boosting vehicle up close to the disabled power unit. Be sure the vehicles do not touch.
4. Shut off the boosting vehicle's engine and set the parking brake.

### **⚠ CAUTION**

Attempting to start the disabled unit with the boosting vehicle's engine running could cause damage to the regulator.

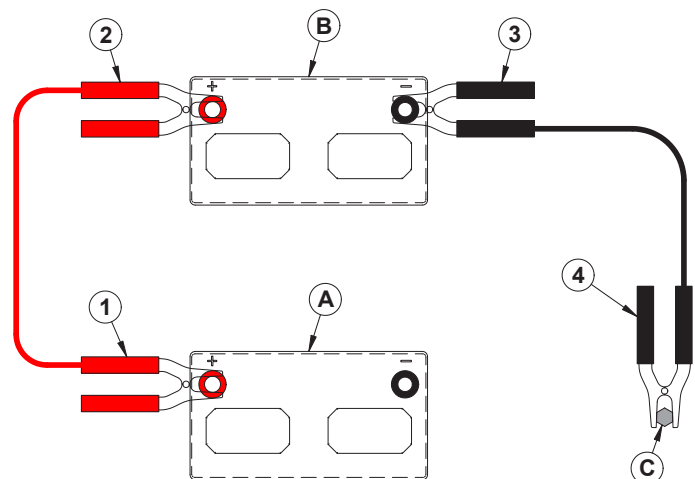

A. Discharged Battery  
B. Booster Battery

C. Ground Stud

5. Connect one end of the positive (+) booster cable to the discharged battery's positive (+) terminal (1).
6. Connect the other end of the positive (+) booster cable to the booster battery's positive (+) terminal (2).

# SERVICE

7. Connect the negative (-) booster cable to the booster battery's negative (-) terminal (3).
8. Connect the other end of the negative (-) booster cable to the disabled power unit's ground stud (4).
9. Start the disabled power unit and remove the booster cables in reverse order of installation (negative booster cable first).

## TCM (Tractor Control Module) Explanation

The Tractor Control Module (A) is a sealed computerized device designed to control the electronic safety related functions of this tractor. Both solid state and mechanical components are used to assure safe, reliable operation of this machine.

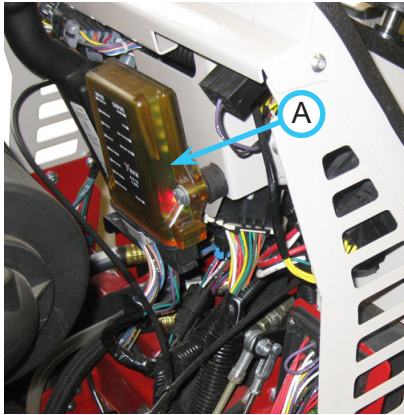

This TCM monitors the electronic circuits necessary for the engine, starter, and PTO to function. These "input" circuits include the PTO Switch, Neutral Switch, Parking Brake Switch, Key Switch, Seat Switch, and Generator Presence. The TCM is programmed to allow the engine, starter, or PTO to operate only when specific input criteria are satisfied. The engine, start, and PTO are controlled by "outputs" from the TCM. For additional information, refer to the TCM section of the troubleshooting guide.

## Replacing Fuses (Power Relay Module)

1. Park the power unit on a level surface.
2. Engage the parking brake and shut off the engine.
3. Remove the key from the ignition switch.
4. Turn the battery disconnect switch to the Off position.
5. Tilt the seat forward and fasten in place with the seat prop.
6. Remove the sealed fuse cap from the power relay module.
7. Identify and pull the defective fuse from the socket.

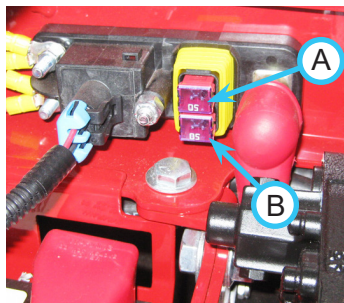

Power Relay module (J-Case Fuse)		
Position	Fuse	Circuit
Top (A)	50 amp	Key Switch, TCM
Bottom (B)	50 amp	Rear Fuse Panel Supply

8. Insert a new fuse into the socket. Be certain to use the correct amperage fuse or damage may occur to the power unit.
9. Reinstall the sealed fuse cap and lower the seat back down to the operating position.
10. Turn the battery disconnect switch to the On position.

## Replacing Fuses (Front Fuse Panel)

1. Park the power unit on a level surface.
2. Engage the parking brake and shut off the engine.
3. Remove the key from the ignition switch.
4. Turn the battery disconnect switch to the Off position.
5. Remove the sealed cover (A) from the fuse panel.
6. Identify and pull the defective fuse from the socket.

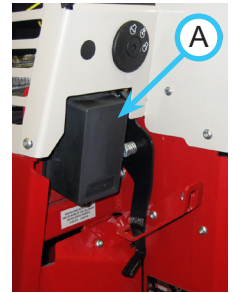

Front Fuse Panel (Mini Fuse)		
Position	Fuse	Circuit
1	15 amp	PTO
2	5 amp	Gauges
3	5 amp	Engine
4	15 amp	Lights
5	10 amp	Fuel Pump
6*	15 amp	Work/Strobe
7*	10 amp	Back-up / Horn / Directional
8	5 amp	Tractor Control Module 1
9^	10 amp	Diesel Stop
10	15 amp	Tractor Control Module 2

\*Optional accessory.

^This position used for diesel units only.

7. Insert a new fuse into the socket. Be certain to use the correct amperage fuse or damage may occur to the power unit.
8. Reinstall the sealed cover onto the fuse panel.
9. Turn the battery disconnect switch to the On position.

# SERVICE

## Replacing Fuses (Rear Fuse Panel)

1. Park the power unit on a level surface.
2. Engage the parking brake and shut off the engine.
3. Remove the key from the ignition switch.
4. Turn the battery disconnect switch to the Off position.
5. Tilt the seat forward and fasten in place with the seat prop.
6. Remove the sealed cover (A) from the fuse panel.
7. Identify and pull the defective fuse from the socket.

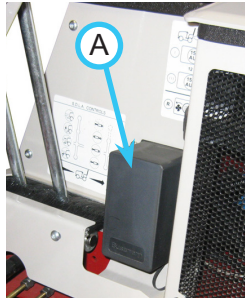

Rear Fuse Panel (Mini Fuse)		
Position	Fuse	Circuit
1*	25 amp (CB)	Spreader
2*	30 amp (CB)	Cab
3*	10 amp	Spreader Vibrator
4*	20 amp	12v Rear
5*	5 amp	Slope Indicator
6*	5 amp	12v Front 1
7*	15 amp	12v Front 2
8*	10 amp	Hyd. Aux
9	5 amp	Seat Switch Circuit
10	25 amp (CB)	Hydraulic Oil Cooler Fan

\*Optional accessory.

8. Insert a new fuse into the socket. Be certain to use the correct amperage fuse or damage may occur to the power unit.
9. Reinstall the sealed cover onto the fuse panel and lower the seat back down to the operating position.
10. Turn the battery disconnect switch to the On position.

## Replacing Fuses (Engine)

1. Park the power unit on a level surface.
2. Engage the parking brake and shut off the engine.
3. Remove the key from the ignition switch and allow the engine to cool.
4. Turn the battery disconnect switch to the Off position.
5. Open the engine hood and remove left engine cover to access the engine compartment.
6. Locate the fuse holder (A) and pull up on the tab to remove the cover.

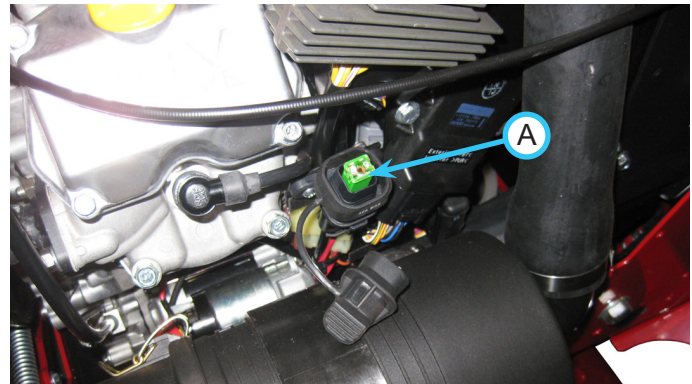

Engine Fuses		
Position	Fuse	Circuit
A	40 amp J-Case	Charge (Kawasaki)

7. Pull the defective fuse from the socket.
8. Insert a new fuse into the socket. Be certain to use the correct amperage fuse or damage may occur to the power unit.
9. Reinstall the fuse cover.
10. Reinstall the left engine cover and close the engine hood.
11. Turn the battery disconnect switch to the On position.

## Switching Speedometer (MPH or Km/H)

1. Park the power unit on a level surface.
2. Engage the parking brake and shut off the engine.
3. Remove the key from the ignition switch.
4. Open the engine hood and follow the harness from the information gauge to locate the green wire (labeled B-144) with the single plug.
5. For speedometer readout in miles per hour, the green wire (B-144) should be connected to the wire from the gauge labeled B-142.
6. For speedometer readout in kilometers per hour, the green wire (B-144) should be connected to the wire from the gauge labeled B-143.



# SERVICE

## Replacing Light Bulbs (Headlights & Halogen Work Lights)

### ⚠ CAUTION

The light bulb contains gases under pressure. The bulb may shatter if the glass is scratched or dropped. Wear eye protection and handle bulb with care.

1. Park the power unit on a level surface.
2. Engage the parking brake and shut off the engine.
3. Remove the key from the ignition switch.
4. Remove the two screws (A) from the light cover and remove the cover.

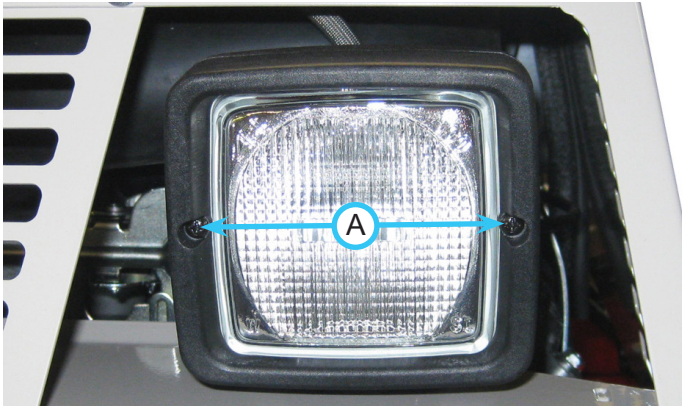

5. Disconnect the light bulb wire from the plug (B).

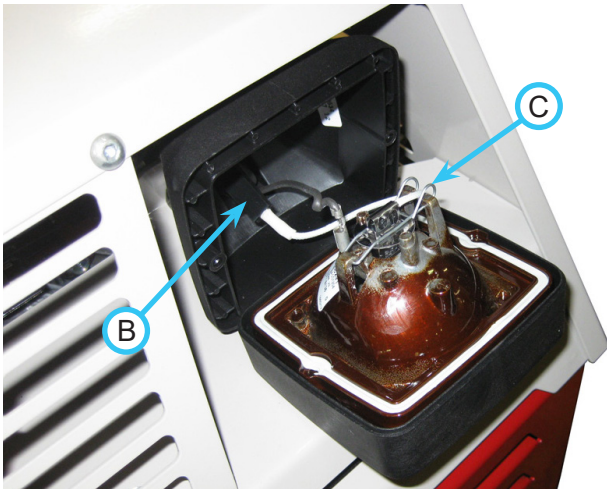

6. Pinch the wire spring fastener (C) and lift away from the light bulb.
7. Remove the defective light bulb.
8. Install the new light bulb and secure with the wire spring fastener.
9. Connect the light bulb wire to the plug.
10. Reinstall the light cover.

## Replacing The Work Lights (LED)

The work lights are equipped with LEDs and do not use a replaceable bulb. If a work light no longer functions, the entire work light must be replaced.

## Replacing The Taillights

The taillights are equipped with LEDs and do not use a replaceable bulb. If a taillight no longer functions, the entire taillight must be replaced.

## Replacing The Turn Signal Lights

The signal lights used for the turn signal / hazard flasher kit are equipped with LEDs and do not use a replaceable bulb. If a signal light no longer functions, the entire light must be replaced.

## Replacing The Strobe Light Bulb (70.4114 Strobe Light Kit)

1. Park the power unit on a level surface.
2. Engage the parking brake and shut off the engine.
3. Remove the key from the ignition switch.

### ⚠ WARNING

#### High Voltage!

Before removing strobe light lens, turn off power and wait five minutes for the capacitor to discharge.

4. Turn the battery disconnect switch to the Off position and wait five minutes for the capacitor to discharge.
5. Unscrew the strobe lens (A) from the base.
6. Hold the circuit board (B) in place with one hand and remove the strobe bulb (C).
7. Install the new strobe bulb, pushing it securely onto the circuit board connectors.
8. Ensure the circuit board and the o-ring are in place and reinstall the strobe lens.
9. Turn the battery disconnect switch to the On position.

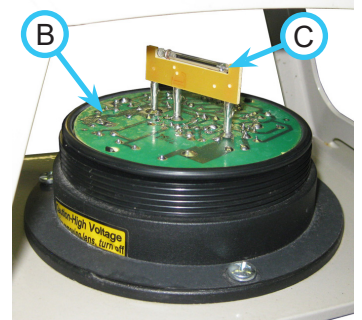

# SERVICE

## Replacing The Strobe Light (70.4155 Strobe Light Kit)

The strobe light in the 70.4155 strobe light kit does not use a replaceable bulb. If the strobe light no longer functions, the entire strobe light must be replaced.

## Changing the Strobe Light Flasher Mode (70.4155 Strobe Light Kit)

1. Remove the four screws that fasten the strobe light to the strobe light frame.
2. Locate the yellow wire from the strobe light. This wire is used to cycle the strobe light modes.
3. Turn the power unit key to the On position to turn on accessory power.
4. Turn the strobe light switch to the On position.
5. Insert the bare end of the yellow wire into the back of the terminal on the red power supply wire to the strobe light. Each time you touch the yellow wire against the red wire, the strobe will change modes.
6. When the desired mode is reached, turn the strobe light switch to the Off position and turn the power unit key to the Off position.
7. Reinstall the strobe light back onto the strobe light frame.

## PTO Belt Inspection

### **⚠ WARNING**

Always set the parking brake, shut off power unit engine, remove the ignition key, and ensure all moving parts have come to a complete stop before inspecting components or attempting any repair or adjustment.

Inspecting the PTO belt (A) of this power unit can prevent sudden belt failure by finding problems before they cause the belt to break. Inspect the PTO belt prior to operation, as part of the daily inspection or anytime a problem is suspected. There may be a PTO belt problem if there is a squealing or chattering sound, or the smell of a slipping belt.

1. Park the power unit on a level surface.
2. Engage the parking brake and shut off the engine.
3. Remove the key from the ignition switch.
4. Check the PTO belt (A) at the PTO idle pulley (B).

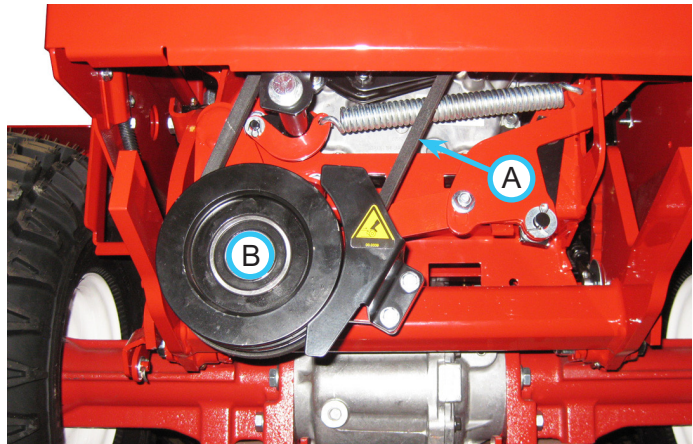

5. Typical wear on a drive belt may result in the conditions shown in the diagram. If any of these conditions occur, the drive belt will require replacement.

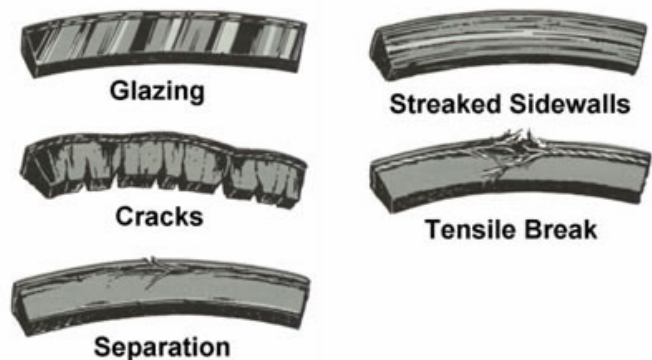

# SERVICE

## PTO Belt Tension Adjustment

1. Park the power unit on a level surface.
2. Engage the parking brake and shut off the engine.
3. Remove the key from the ignition switch.
4. Pull out on the PTO belt tensioner rod to release tension on the belt tensioner linkage.
5. Loosen the adjustment bolt (A) and rotate the tension adjustment link (B) clockwise to increase the tension applied to the PTO and attachment belts. Rotate the tension adjustment link counterclockwise to decrease the tension applied to the PTO and attachment belts.

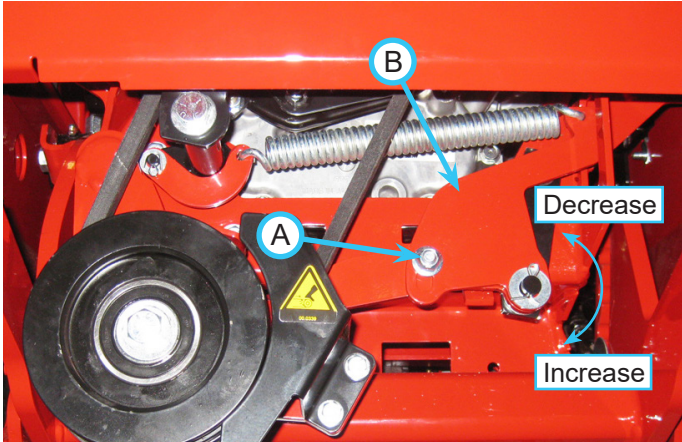

6. Tighten the adjustment bolt securely. Torque to 31 ft-lbs (42 Nm).

## PTO Belt Replacement

1. Park the power unit on a level surface.
2. Engage the parking brake and shut off the engine.
3. Remove the key from the ignition switch and allow the engine to cool.
4. Open the engine hood and remove right engine cover.
5. Remove the PTO idler pulley guard (A).

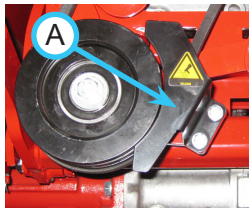

6. Pull the PTO belt tensioner rod out to release the belt tension.

7. Remove the hairpin (B) and washer that fastens the belt tensioner rod to the belt tensioner rocker.

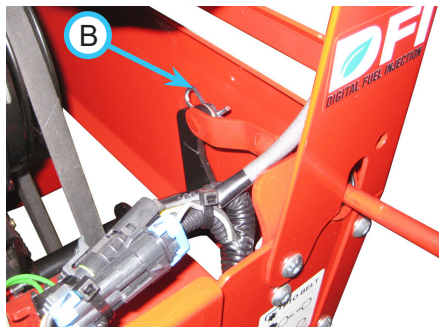

8. Remove the belt tensioner rod from the belt tensioner rocker.



9. Lift up on the PTO idler pulley and remove the belt from the pulley.

10. Pull the belt up between the PTO tension rocker and the front grill. If necessary, rotate the PTO tension rocker to increase the gap between the rocker and the grill.

11. Push the new belt down between the PTO tension rocker and the front grill (it may be necessary to turn the belt sideways).

12. Install the belt onto the clutch pulley.

13. Lift up on the PTO idler pulley and install the belt in the rear groove of the idler pulley.

14. Reinstall the PTO belt tensioner rod to the belt tensioner rocker and fasten with the hairpin and washer.

15. Reinstall the PTO idler pulley guard. Torque bolts to 100 in-lbs (11 Nm).

16. Reinstall the right engine cover and close the engine hood.

## Clutch Air Gap Inspection & Adjustment

The electric clutch is activated by the PTO switch to engage or disengage power to belt driven attachments. The clutch also provides braking action to stop the attachment when the PTO is disengaged or the operator presence circuit is interrupted.

For proper operation, the air gap between the armature and the rotor must be set at .020" (.5 mm). If the air gap is too narrow, the clutch armature may drag when disengaged, causing premature failure. If the air gap is too wide, the clutch may not engage correctly or it may disengage when it becomes hot. Check the air gap annually and adjust the clutch air gap as necessary.

1. Locate the three inspection windows (A) on the clutch.

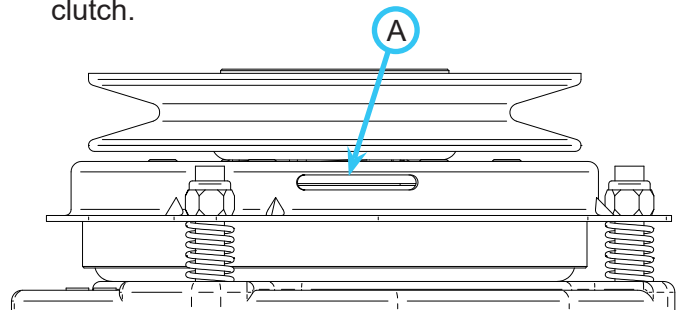

# SERVICE

- Place a .020" (.5 mm) feeler gauge in the slot between the armature and the rotor.

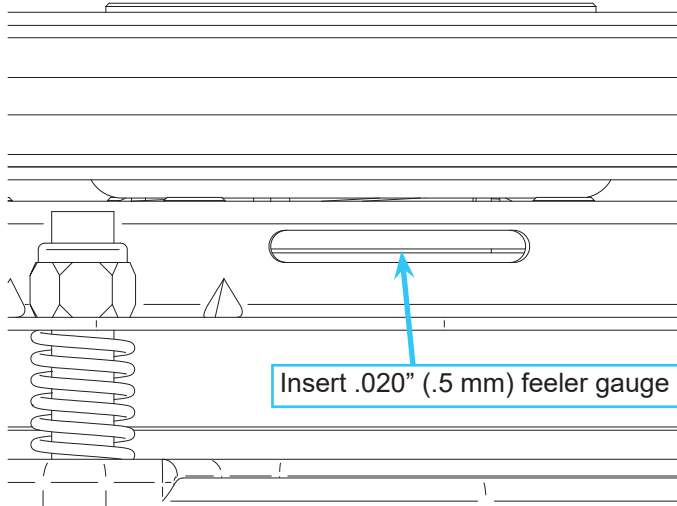

- Tighten or loosen the clutch adjustment nut (B) as needed to achieve the .020" (.5 mm) air gap.

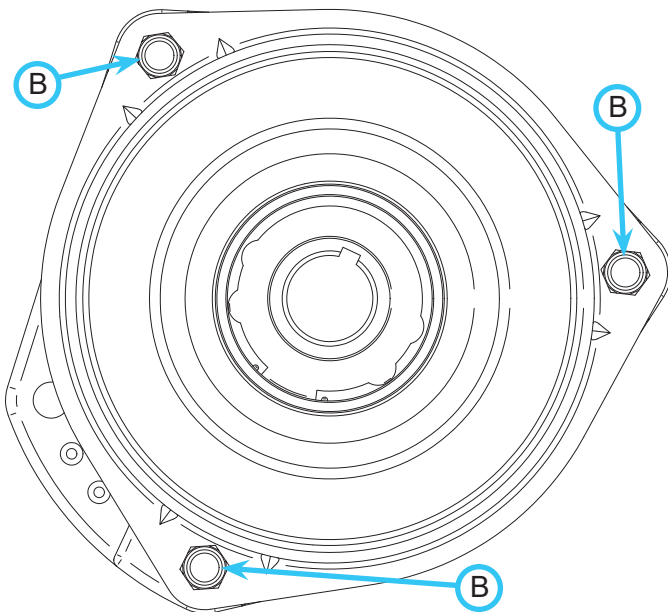

## Wheel Removal & Installation

### Wheel Removal:

- Park the power unit on a level surface.
- Engage the parking brake and shut off the engine.
- Remove the key from the ignition switch.
- Loosen the wheel lug nuts, but do not remove.

### **⚠ WARNING**

If power unit is not adequately supported, the unit could accidentally fall and trap or crush a person or appendage, causing severe injury or death.

- Lift up the corner of the power unit and secure with a jack stand.
- Remove the lug nuts and lift the wheel off the mounting studs.

### Wheel Installation:

- Place the wheel onto the mounting studs with the hub side of the rim against the axle hub.  
NOTE: if the wheel is equipped with a single valve stem, the valve stem will be to the outside of the power unit. If the wheel is equipped with dual valve stems, there is a decal on the rim that specifies the hub side of the rim.
- Install the lug nuts and tighten by hand until the wheel is held against the axle hub.
- Lift the power unit up slightly and remove the jack stand. Lower the power unit to the ground.
- Tighten the wheel nuts in a crisscross sequence as shown. Torque to 55 ft-lbs (75 Nm).

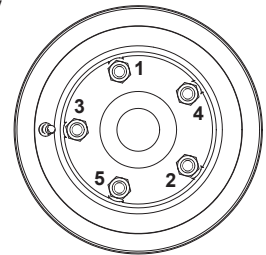

## Outer Dual Wheel Removal & Installation

- Raise the power unit approximately 2 inches (5 cm) by driving the power unit onto wood planks positioned in line with the inner wheels. The outer wheels should not contact the wood planks.
- Engage the parking brake and shut off the engine.
- Remove the key from the ignition switch.
- Place wheel chocks in front and back of the inner wheels to prevent accidental movement.

### **⚠ WARNING**

Place wheel chocks in front and back of the inner wheels to prevent the power unit from rolling during removal or installation of outer dual wheels.

A jack and jack stands may be used if planks are not available.

### Outer Dual Wheel Removal:

- Loosen the draw bolts approximately 5 turns.
- With a medium size hammer, hit the end of the draw bolt until the draw cone releases.
- Remove the dual wheel assemblies by rotating counter-clockwise.
- Install the plastic plugs from the dual wheel kit into the inner dual wheel hubs on all four tires.
- If desired, move the steering cylinder to the inner hole setting of the cylinder mount under

# SERVICE

the left front corner of the foot platform. Torque to 150 ft-lbs (203 Nm).

## Outer Dual Wheel Installation:

1. Remove the plastic plugs from the inner dual wheel hubs.
2. Inspect the threaded end of the dual wheel extensions to ensure the draw cone, draw bolt, and the external threads of the dual wheel extension have a light coating of grease. Apply grease if necessary.
3. The draw cone must be loose before installing the dual wheel extension into the inner hub. Check by sliding the draw bolt in and out. It should have 1/4" to 1/2" (6.5 to 13 mm) of travel.
4. Insert the threaded end of the dual wheel extension into the inner dual wheel hub. Using both hands, turn the dual wheel assembly clockwise until the wheel is tight and there are four threads or fewer visible on the outer hub. This is to ensure the hubs lock correctly when the draw bolt is tightened. Repeat for the other three wheels.

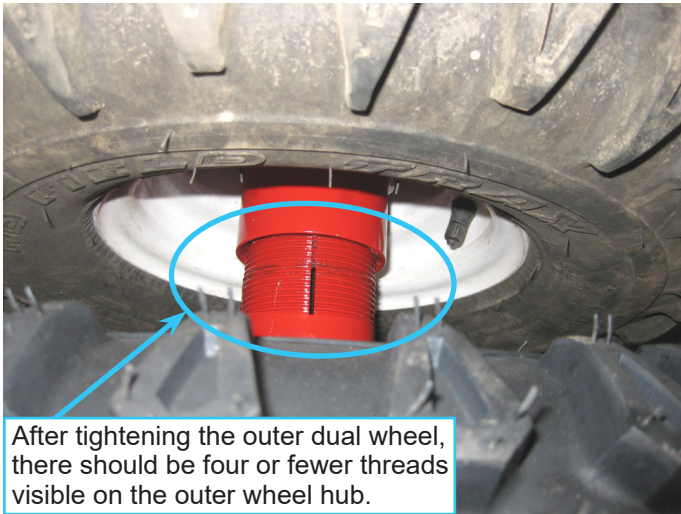

5. Tighten the draw bolt and torque to 120 ft-lbs (163 Nm). Repeat for the other three wheels.
6. If the steering cylinder is mounted to the inner hole setting of the steering cylinder mount, move the steering cylinder to the center hole setting of the steering cylinder mount under the left front corner of the foot platform. Torque to 150 ft-lbs (203 Nm).

## Tire Pressure

Check the tire pressure prior to operation, as part of the daily inspection. Keep tires evenly inflated. Keep tire inflation within the proper range to prevent premature wear and/or poor traction.

Tire	Single Wheel	Dual Wheels	
		Inner	Outer
All Terrain	8-16 psi (55-110 kPa)	8-10 psi (55-69 kPa)	6-8 psi (41-55 kPa)
Bar	8-16 psi (55-110 kPa)	8-10 psi (55-69 kPa)	6-8 psi (41-55 kPa)
Turf	15-20 psi (103-138 kPa)	15-17 psi (103-117 kPa)	10-12 psi (69-83 kPa)

## ROPS And Seat Belt Inspection

### ⚠ WARNING

Failure to inspect and maintain the Roll-Over Protection System and seat belt can lead to serious injury or death.

If any part of the ROPS experiences structural damage, the entire ROPS must be replaced.

Inspect the roll bar and seat belt prior to operation, as part of the daily inspection.

1. Inspect the roll bar for damage, missing components, and loose or missing hardware. Replace any damaged or missing components and tighten loose hardware prior to operating the power unit.
2. Inspect the seat belt webbing for cuts, abrasions, fraying, or excessive wear.
3. Inspect the seat belt webbing for damage from exposure to the sun's ultraviolet rays. If the original color of the webbing is extremely faded, the physical strength of the webbing may be deteriorated.
4. Inspect the seat belt webbing for dust and dirt. If the webbing is packed with dirt, the physical strength of the webbing may be deteriorated.
5. Inspect the seat belt webbing for stiffness. If the webbing is no longer flexible, the physical strength of the webbing may be deteriorated.
6. Inspect the seat belt buckle and latch for damage, cracks, or excessive wear.
7. Inspect the seat belt for proper operation. The seat belt should latch securely and release smoothly. Seat belt adjustment should be accomplished without excessive resistance.

If any problems are detected during this inspection, the component must be replaced prior to operating the power unit.

# SERVICE

## Parking Brake Inspection & Adjustment

The parking brake tension must be set to require a minimum of 15 pounds (7 kg) of force to engage the brake lever 7 clicks or less from the off position. If less than 15 lbs (7 kg) of force is required to engage the brake lever 7 clicks or less from the off position, or if engaging the parking brake will not prevent the power unit from moving, the brake linkage rod will need to be adjusted.

1. Park the power unit on a level surface.
2. Shut off the engine and remove the key from the ignition switch.

### **⚠ WARNING**

The parking brake must be disengaged as part of the adjustment procedure. Park the power unit on a level surface and place wheel chocks in front and back of wheels to prevent the power unit from rolling forward or backward.

3. Place wheel chocks in front and back of wheels to prevent power unit from rolling.
4. Disengage the parking brake to remove tension from the brake linkage.
5. Tighten the 1/4" lock nut (A) on the brake linkage rod several turns and recheck the amount of force required to engage the brake lever. Continue adjusting the 1/4" lock nut until there is a minimum of 15 lbs (7 kg) of force required to engage the brake lever 7 clicks or less from the off position.

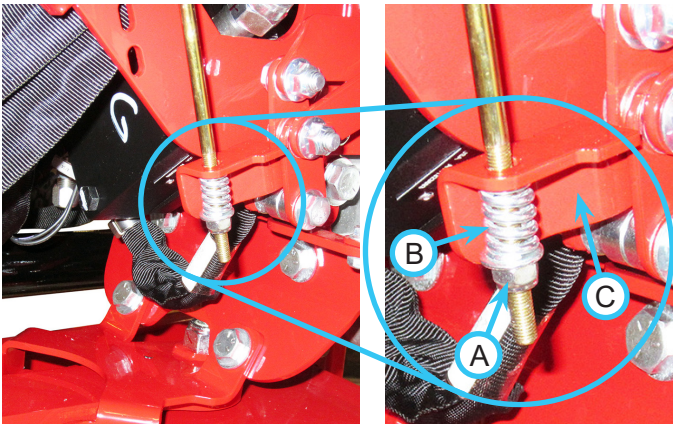

6. After the required amount of force to engage the brake lever is achieved, disengage the parking brake and move the SDLA lever forward as far as it will go. While moving the SDLA lever forward, observe the compression spring (B) and brake engagement tab (C) on the brake linkage. The compression spring on the brake linkage rod should not cause the brake engagement tab to be lifted up more than .03" (.8 mm). If the

brake engagement tab moves more than that, it is possible for the brake to drag when travelling at full forward speed, causing premature wear of the brake.

7. If it is not possible to get the required 15 lbs (7 kg) of force to engage the brake lever 7 clicks or less from the off position without causing the brake engagement tab to move more than .03" (.8 mm) with the SDLA lever in the full forward position, the parking brake band may need further service. Contact your authorized Ventrac dealer for assistance.

## Neutral Adjustment

The power unit should come to a complete stop with the neutral assist lever in the On position and the parking brake disengaged. The power unit should not attempt to move with the parking brake engaged. If the power unit is attempting to move, there will be an excessive amount of pump hydraulic noise, which indicates the pump is not in the neutral position.

If the power unit moves or attempts to move in either condition, the neutral position must be adjusted.

1. Remove any attachment from the power unit.
2. Park the power unit on a level surface.
3. Engage the parking brake and shut off the engine.
4. Remove the key from the ignition switch.
5. Remove the pump cover from the power unit.

### **⚠ WARNING**

Do not attempt to adjust the neutral position with the power unit wheels on the ground. The power unit could accidentally move forward or backward, causing severe injury or death.

If power unit is not adequately supported, the unit could accidentally fall and trap or crush a person or appendage, causing severe injury or death.

6. Lift the power unit so all four wheels are a minimum of 2" (5 cm) off the ground and secure the power unit with jack stands or supporting blocks. Make sure the jack stands or supporting blocks will not make contact with the wheels when they rotate.
7. Place a weight of 50 lbs (22.5 kg) on the seat so the operator presence switch is activated.
8. Place the neutral assist lever in the On position to engage the neutral assist spring.
9. Start the power unit and adjust the engine speed to approximately 2,000 RPM.
10. Locate the neutral adjustment bolt (A) on the

# SERVICE

lower right side of the front frame (right column panel), directly below the neutral assist lever.

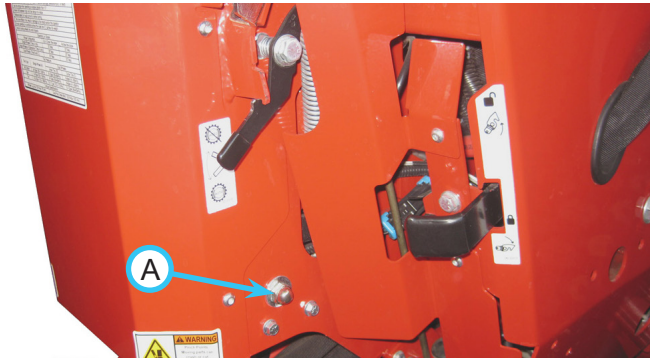

11. Loosen the acorn nut (A) slightly. NOTE: it is easier to attain the desired setting if the neutral adjustment bolt is left snug and a rubber mallet or a piece of wood and a metal hammer are used to tap the bolt in the desired direction. Do not strike the acorn nut directly with a metal hammer, as it is possible to dent or damage the nut.
12. Release the parking brake and observe which direction the tires are moving. If the tires are rotating in the forward direction, the neutral adjustment bolt should be moved up in the frame slot. If the tires are rotating in the reverse direction, the neutral adjustment bolt should be moved down in the frame slot.
13. Once the proper neutral position is found and the tires do not rotate any longer, tighten the neutral adjustment bolt to 31 ft-lbs (42 Nm). Make sure to hold the bolt head to help prevent the neutral adjustment bolt from moving in the slot when it is tightened.
14. Verify that the neutral position is still correct after tightening the bolt by moving the SDLA lever in the forward and reverse directions and allowing the spring return to move the lever back to the neutral position. Observe the tires to see if there is any movement. Repeat steps 11-13 as needed until there is no movement of the tires.
15. Engage the parking brake and listen for abnormal amounts of pump hydraulic noise. Repeat steps 11-13, if necessary.

## **⚠ WARNING**

An improperly adjusted neutral switch can result in erratic engine cranking or unsafe power unit movement. Check the neutral switch position anytime an adjustment is made to the neutral position.

16. Adjustments made to the neutral adjustment bolt may affect the neutral switch setting. After

changing the neutral setting, it is possible that the power unit will not start, due to the neutral switch being out of adjustment. Refer to the neutral switch adjustment section for procedure on correctly setting the neutral switch position.

17. Engage the parking brake and shut off the engine.
18. Reinstall the pump cover onto the power unit.
19. Remove the weight from the power unit seat.
20. Remove the power unit from the jack stands or supporting blocks and return to the ground.

## Neutral Switch Adjustment

### **⚠ WARNING**

An improperly adjusted neutral switch can result in erratic engine cranking or unsafe power unit movement. Check the neutral switch position anytime an adjustment is made to the neutral position.

1. Park the power unit on a level surface.
2. Engage the parking brake and shut off the engine.
3. Remove the key from the ignition switch.
4. Remove the pump cover from the power unit.

### **⚠ WARNING**

The parking brake must be disengaged as part of the adjustment procedure. Park the power unit on a level surface and place wheel chocks in front and back of wheels to prevent the power unit from rolling forward or backward.

5. Place wheel chocks in front and back of wheels to prevent power unit from rolling.
6. Disengage the parking brake.
7. Turn the ignition key to the key switch's Run position to activate the electrical system, but do not start the engine.
8. Open the power unit's hood and locate the tractor control module (TCM) The neutral switch input light (A - 2nd light down from the top on the left side of the TCM) will be used as an indicator for when the neutral switch is on or off.

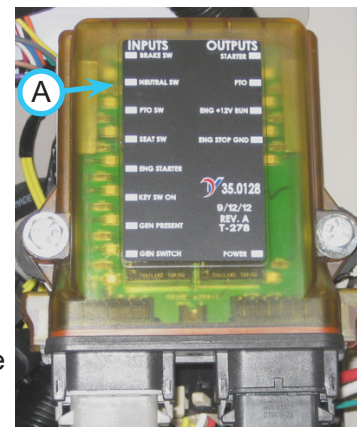

# SERVICE

9. Measure the distance between the front frame (B) and the pump arm (C) and record for reference.

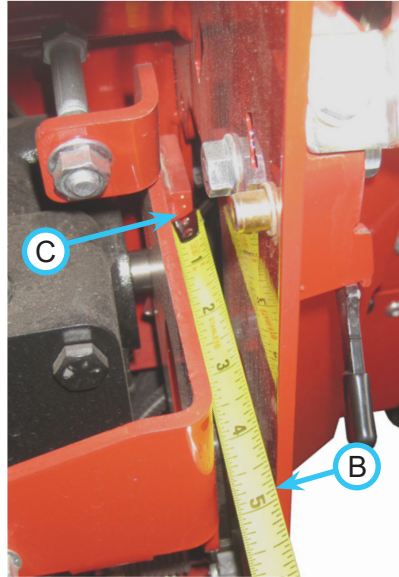

10. Move the SDLA lever slowly in the forward direction while watching the neutral switch input light. When the light goes out, stop the SDLA lever and measure the distance

between the front frame and the pump arm. This measurement should be a minimum of 1/32" (.8 mm) less and a maximum of 1/16" (1.6 mm) less than the measurement taken in step 9 (ex. if measurement in step 9 was 4" (101.6 mm), the measurement when the light goes out must be between 3-31/32" (100.8 mm) and 3-15/16" (100 mm)).

NOTE: it may be helpful to have an assistant to take the measurements.

11. If the measurement is not within the specified range, adjust the neutral switch mount (D) by loosening the two mounting bolts and sliding the mount in the necessary direction. Tighten the switch mount hardware to 100 in-lbs (11 Nm).



12. Repeat steps 10 and 11 as needed until the measurement is within the specified range.
13. Turn off the key switch and close the engine hood.
14. Engage the parking brake.
15. Reinstall the pump cover onto the power unit.
16. Remove the wheel chocks.
17. If you are unsure of the correct procedure to adjust the neutral switch, or if you are unable to attain the correct setting, contact your authorized Ventrac dealer for assistance.

## Storage

### Preparing the Power Unit for Storage

1. Clean the power unit.



### Attention

To maintain the finish of the power unit and attachment, thoroughly wash the equipment to remove any corrosive agents (e.g., salt). Failure to clean the equipment may result in corrosion of (including but not limited to) steel, aluminum, and electrical components.

2. Inspect for loose or missing hardware, damaged components, or signs of wear.
3. Inspect the ROPS structure and seat belt for damage or signs of wear..
4. Inspect safety decals. Replace any safety decals that are faded, illegible, or missing.
5. Inspect hydraulic hoses for leaks and/or wear. Service as required.
6. Inspect hydraulic hoses, hydraulic fittings, and fuel lines to ensure tight, leak free connections.
7. Ensure parking brake tension is properly adjusted.
8. Inspect electrical system and connections.
9. Test the operator safety interlock system.
10. Perform a TCM (tractor control module) check to make sure the inputs and outputs are correct. Refer to the troubleshooting section for input and output information.
11. Inspect the PTO pulley and belt for damage or excessive wear. Service as required.
12. Inspect the electric PTO clutch air gap. Set gap to .020" (.5 mm).
13. Check the hydraulic oil level. Add fluid or service as required.
14. Check the coolant level and make sure the temperature protection range is at least -34° F (-37° C). Add fluid or service as required.
15. Ensure the radiator screen, air cleaner, and engine compartment are clean.
16. Check tires for proper inflation.
17. Grease and lubricate all points specified in the maintenance section. Wipe off any excess grease or oil.

After all the above steps have been performed, complete the preparation for storage by performing the steps for either long term storage (4 months or longer) or short term storage (less than 4 months).



# SERVICE

---

## **Long Term Storage (4 Months or Longer)**

1. Change the engine oil to prevent damage that can be caused by acidic build up in used motor oil.
2. Drain all fuel out of the fuel tank, start the power unit, and allow to run until the engine stops to ensure all fuel is out of the fuel lines, carburetor passages, injectors, etc.
3. Turn the key to the off position and remove.
4. Engage the parking brake.
5. Turn the fuel shut-off valve to the Off position.
6. Turn the battery disconnect to the Off position.
7. If the power unit is being stored in a cold climate (below 35° F (2° C)), remove the battery from the power unit and store in a warm location. Check the battery charge level periodically and charge the battery, if necessary.

## **Short Term Storage (Less than 4 Months)**

1. Add a good quality fuel stabilizer to the fuel tank. Follow the manufacturer's recommended mixing ratios.
2. Start the power unit's engine and run for 10 minutes to allow the fuel stabilizer to travel all through the fuel system.
3. Turn off the power unit engine and remove the key.
4. Engage the parking brake.
5. Turn the fuel shut-off valve to the Off position.
6. Turn the battery disconnect to the Off position.
7. Check the battery charge level periodically and charge the battery, if necessary.

## **Removing the Power Unit from Storage**

1. Clean the power unit to remove any accumulated dust or debris.
2. Inspect the power unit as instructed in the daily inspection section of this manual.
3. Test the power unit to ensure all components and systems are working properly.

# SERVICE

## Maintenance Schedule

Maintenance Schedule	# of Locations	# of Pumps	AS NEEDED	After First 8 Hrs.	Daily	At 50 Hours	At 100 Hours	At 150 Hours	At 200 Hours	At 250 Hours	At 300 Hours	At 350 Hours	At 400 Hours	At 450 Hours	At 500 Hours	At 550 Hours	At 600 Hours	At 650 Hours	At 700 Hours	At 750 Hours	At 800 Hours	At 850 Hours	At 900 Hours	At 950 Hours	At 1000 Hours	Yearly	1500 hours*	
Grease & Lubrication: See Lubrication Section																												
Front Hitch	2	1	✓		✓	✓	✓	✓	✓	✓	✓	✓	✓	✓	✓	✓	✓	✓	✓	✓	✓	✓	✓	✓	✓	✓	✓	✓
Lift Cylinder	2	1	✓		✓	✓	✓	✓	✓	✓	✓	✓	✓	✓	✓	✓	✓	✓	✓	✓	✓	✓	✓	✓	✓	✓	✓	✓
Center Pivot	1	1	✓		✓	✓	✓	✓	✓	✓	✓	✓	✓	✓	✓	✓	✓	✓	✓	✓	✓	✓	✓	✓	✓	✓	✓	✓
Steering Cylinder	2	1	✓		✓	✓	✓	✓	✓	✓	✓	✓	✓	✓	✓	✓	✓	✓	✓	✓	✓	✓	✓	✓	✓	✓	✓	✓
Drive-Shaft	2	1	✓		✓	✓	✓	✓	✓	✓	✓	✓	✓	✓	✓	✓	✓	✓	✓	✓	✓	✓	✓	✓	✓	✓	✓	✓
3 Pt Cylinder @	2	1	✓		✓	✓	✓	✓	✓	✓	✓	✓	✓	✓	✓	✓	✓	✓	✓	✓	✓	✓	✓	✓	✓	✓	✓	✓
3 Pt Pivot @	2	1	✓		✓	✓	✓	✓	✓	✓	✓	✓	✓	✓	✓	✓	✓	✓	✓	✓	✓	✓	✓	✓	✓	✓	✓	✓
Lower Connector Link	2	1	✓		✓	✓	✓	✓	✓	✓	✓	✓	✓	✓	✓	✓	✓	✓	✓	✓	✓	✓	✓	✓	✓	✓	✓	✓
Seat Slide	2	#	✓		✓	✓	✓	✓	✓	✓	✓	✓	✓	✓	✓	✓	✓	✓	✓	✓	✓	✓	✓	✓	✓	✓	✓	✓
Engine <sup>1</sup>																												
Check Engine Oil Level				✓																								
Change Engine Oil & Filter <sup>1</sup>			✓			✓		✓		✓		✓		✓		✓		✓		✓		✓		✓		✓		✓
Clean/Replace Spark Plugs (Gasoline Engines)	Consult Engine Owner's Manual; Follow Service Intervals for Heavy Loads and High Temperatures*																											
Inspect Primary Air Filter				✓																								
Replace Primary Air Filter	**				**	✓		**	✓	**	✓	**	✓	**	✓	**	✓	**	✓	**	✓	**	✓	**	✓	**	✓	**
Replace Safety Air Filter																												
Check Coolant Level				✓																								
Service Cooling System																												✓
Clean Engine Compartment, Engine, & Radiator	**		✓																									
Replace Fuel Filter	✓											✓																
Drain Water & Sediment from Fuel Tank	✓																											✓
Hydraulic System																												
Check Hydraulic Oil Level				✓																								
Check Rear Transaxle Oil Level									✓						✓											✓	✓	
Change Hydraulic Filters <sup>2</sup>						✓								✓														✓
Change Hydraulic Oil and Rear Transaxle Oil <sup>2</sup>														✓														✓
Parking Brake																												
Parking Brake Inspection & Adjustment				✓																								
Electrical																												
Replace Light Bulbs	✓																											
Clean Battery Terminals & Compartment	✓																											✓
Inspection																												
Inspect Operator Interlock System				✓																								
Inspect ROPS structure and seatbelt				✓																								
Inspect for Loose, Missing, or Worn Components				✓																								
Inspect Battery, Electrical Connections, and Lights				✓																								
Inspect Belts, Fuel Lines, and Hydraulic Lines				✓																								
Check Tire Pressure.				✓																								
Check Wheel Lug Nuts. Torque to 55 ft-lbs (75 Nm)				✓	✓				✓					✓					✓						✓			
Check Steering Cylinder Bolts. Torque to 150 ft-lbs (203 Nm)					✓	✓		✓	✓	✓	✓	✓	✓	✓	✓	✓	✓	✓	✓	✓	✓	✓	✓	✓	✓	✓	✓	✓
Check Front/Rear Connector Link Bolts. Torque to 150 ft-lbs (203 Nm)					✓	✓		✓	✓	✓	✓	✓	✓	✓	✓	✓	✓	✓	✓	✓	✓	✓	✓	✓	✓	✓	✓	✓
Check Front Hitch Pivot Bolts. Torque to 150 ft-lbs (203 Nm)					✓	✓		✓	✓	✓	✓	✓	✓	✓	✓	✓	✓	✓	✓	✓	✓	✓	✓	✓	✓	✓	✓	✓
* If heavy load, high temperature, or dusty condition service intervals are not specified, Ventrac recommends servicing more frequently at 1/2 the standard service interval.																												
** Operation in severe conditions may require more frequent service intervals.																												
<sup>1</sup> Consult Engine Owner's Manual for engine oil information and complete servicing information																												
<sup>@</sup> Optional Equipment																												
<sup>^</sup> Grease Until Fresh Grease is visible																												
<sup>#</sup> Silicon Based Spray Lubricant																												
<sup>%</sup> Hydraulic filters initial change @ 100 hours. Change oil and filters @ 500 hours, then every 1000 hours.																												

# SERVICE

## Maintenance Checklist

Maintenance Checklist	# of Locations	# of Pumps	As NEEDED	After First 8 Hrs.	Daily	At 50 Hours	At 100 Hours	At 150 Hours	At 200 Hours	At 250 Hours	At 300 Hours	At 350 Hours	At 400 Hours	At 450 Hours	At 500 Hours	At 550 Hours	At 600 Hours	At 650 Hours	At 700 Hours	At 750 Hours	At 800 Hours	At 850 Hours	At 900 Hours	At 950 Hours	At 1000 Hours	Yearly	1500 Hours*	
Grease & Lubrication: See Lubrication Section																												
Front Hitch	2	1																										
Lift Cylinder	2	1																										
Center Pivot	1	1																										
Steering Cylinder	2	1																										
Drive-Shaft	2	1																										
3 Pt Cylinder @	2	1																										
3 Pt Pivot @	2	1																										
Lower Connector Link	2	1																										
Seat Slide	2	#																										
Engine <sup>1</sup>																												
Check Engine Oil Level																												
Change Engine Oil & Filter <sup>1</sup>																												
Clean/Replace Spark Plugs (Gasoline Engines)	Consult Engine Owner's Manual; Follow Service Intervals for Heavy Loads and High Temperatures*																											
Inspect Primary Air Filter																												
Replace Primary Air Filter																												
Replace Safety Air Filter																												
Check Coolant Level																												
Service Cooling System																												
Clean Engine Compartment, Engine, & Radiator																												
Replace Fuel Filter																												
Drain Water & Sediment from Fuel Tank																												
Hydraulic System																												
Check Hydraulic Oil Level																												
Check Rear Transaxle Oil Level																												
Change Hydraulic Filters <sup>%</sup>																												
Change Hydraulic Oil and Rear Transaxle Oil <sup>%</sup>																												
Parking Brake																												
Parking Brake Inspection & Adjustment																												
Electrical																												
Replace Light Bulbs																												
Clean Battery Terminals & Compartment																												
Inspection																												
Inspect Operator Interlock System																												
Inspect ROPS structure and seatbelt																												
Inspect for Loose, Missing, or Worn Components																												
Inspect Battery, Electrical Connections, and Lights																												
Inspect Belts, Fuel Lines, and Hydraulic Lines																												
Check Tire Pressure.																												
Check Wheel Lug Nuts. Torque to 55 ft-lbs (75 Nm)																												
Check Steering Cylinder Bolts. Torque to 150 ft-lbs (203 Nm)																												
Check Front/Rear Connector Link Bolts. Torque to 150 ft-lbs (203 Nm)																												
Check Front Hitch Pivot Bolts. Torque to 150 ft-lbs (203 Nm)																												
* If heavy load, high temperature, or dusty condition service intervals are not specified, Ventrac recommends servicing more frequently at 1/2 the standard service interval.																												
** Operation in severe conditions may require more frequent service intervals.																												
<sup>1</sup> Consult Engine Owner's Manual for engine oil information and complete servicing information																												
<sup>@</sup> Optional Equipment																												
<sup>^</sup> Grease Until Fresh Grease is visible																												
<sup>#</sup> Silicon Based Spray Lubricant																												
<sup>%</sup> Hydraulic filters initial change @ 100 hours. Change oil and filters @ 500 hours, then every 1000 hours.																												

## Ventrac Maintenance Log

Model Number: \_\_\_\_\_

Serial Number:

-

Date:	Hours:	Description of Repairs/Service	Initials



**Blank Page**

# TROUBLESHOOTING

## Wiring Diagram Reference Key

### Harness Section Identifier

A = 32.0108 - Harness, Rear  
B = 32.0109 - Harness, Dash  
C = 32.0110 - Harness, Front  
D = 32.0107 - Harness, B&S Engine  
E = 32.0105 - Harness, Kawasaki Engine  
F = 32.0104 - Harness, Kubota Gas  
G = 32.0106 - Harness, Kubota Diesel  
H =  
I =  
J = 32.0114 - Harness, Kit - 12v Front  
K = 32.0113 - Harness, Kit - 12v Rear  
L = 32.0120 - Harness, Kit - 12v Dual Hydraulic  
M = 32.0119 - Harness, Kit - Propane  
N = 32.0121 - Harness, Kit - PTO Remote  
O = 32.0115 - Harness, Kit - Horn  
P = 32.0122 - Harness, Kit - Backup Alarm  
Q = 32.0118 - Harness, Kit - Directional  
R = 32.0117 - Harness, Kit - Strobe Light  
S = 32.0116 - Harness, Kit - Work Light  
T = 32.0123 - Harness, Kit - Slope Indicator

\*@ = 32.0160 - Harness, Kubota WG972  
" ^ = 32.0159 - Harness, Kawasaki FD851D Fused

----- = \*Black Wire  
———— = White Wire  
||| ——— = Ground  
● = Splice or Connection

\* All black wires that are part of the wire harness are part of the ground circuit. However, some components such as lights may be wired where black may be positive.

All other wires colors are as shown

Anything outlined with a blue box is a Standard Feature

Anything outlined with a Green box is a Option

\* **Actual wires not labeled on tractor harness**

### Wire Color & Circuit Type

Black = Ground  
Dark Blue = Pre-Heat  
Lt Blue = Safety Circuit  
Brown = Engine Run / Kill  
Gray = 12v Aux / Horn power  
Green = Start/Speed/Directional  
Lt Green = 12 Aux  
Orange = Propane / Slope  
Pink = Alarm  
Purple = PTO  
Red = Power  
Tan = RPM  
White = Power  
Yellow = Light/Directional

# TROUBLESHOOTING

## Wiring Diagram - Rear Harness

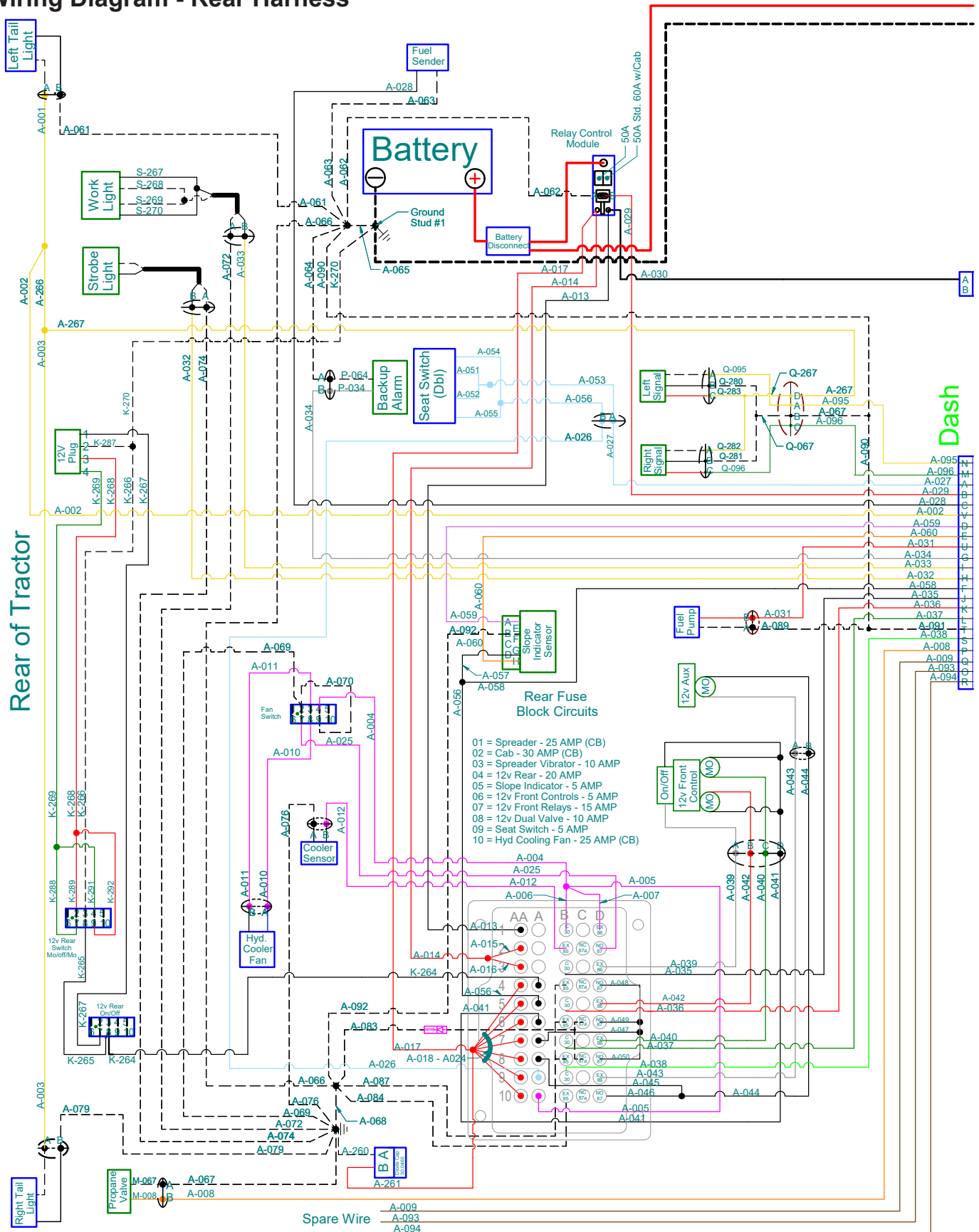



# TROUBLESHOOTING

## Wiring Diagram - Front Harness

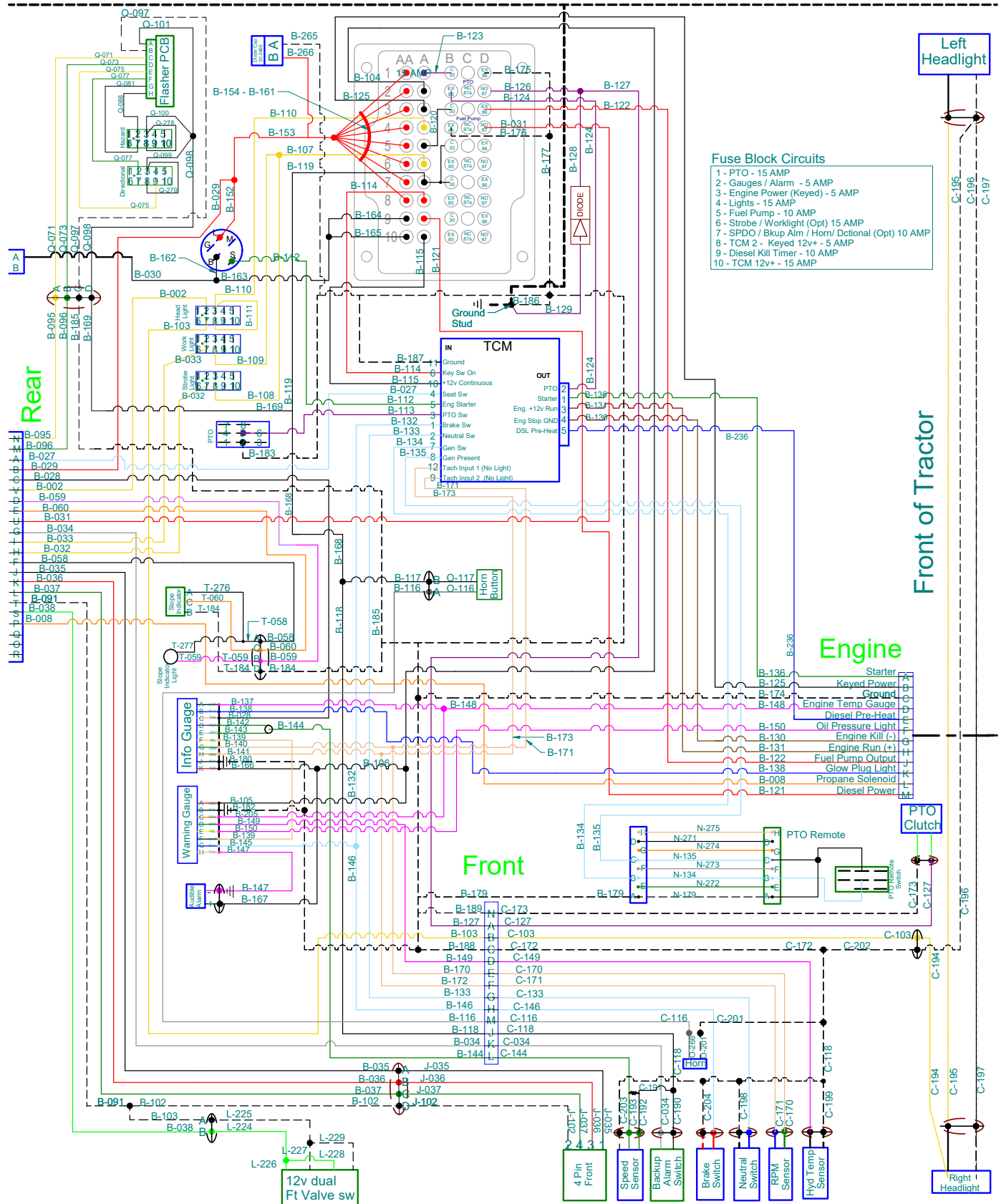

# TROUBLESHOOTING

## Wiring Diagram - Engine Harness

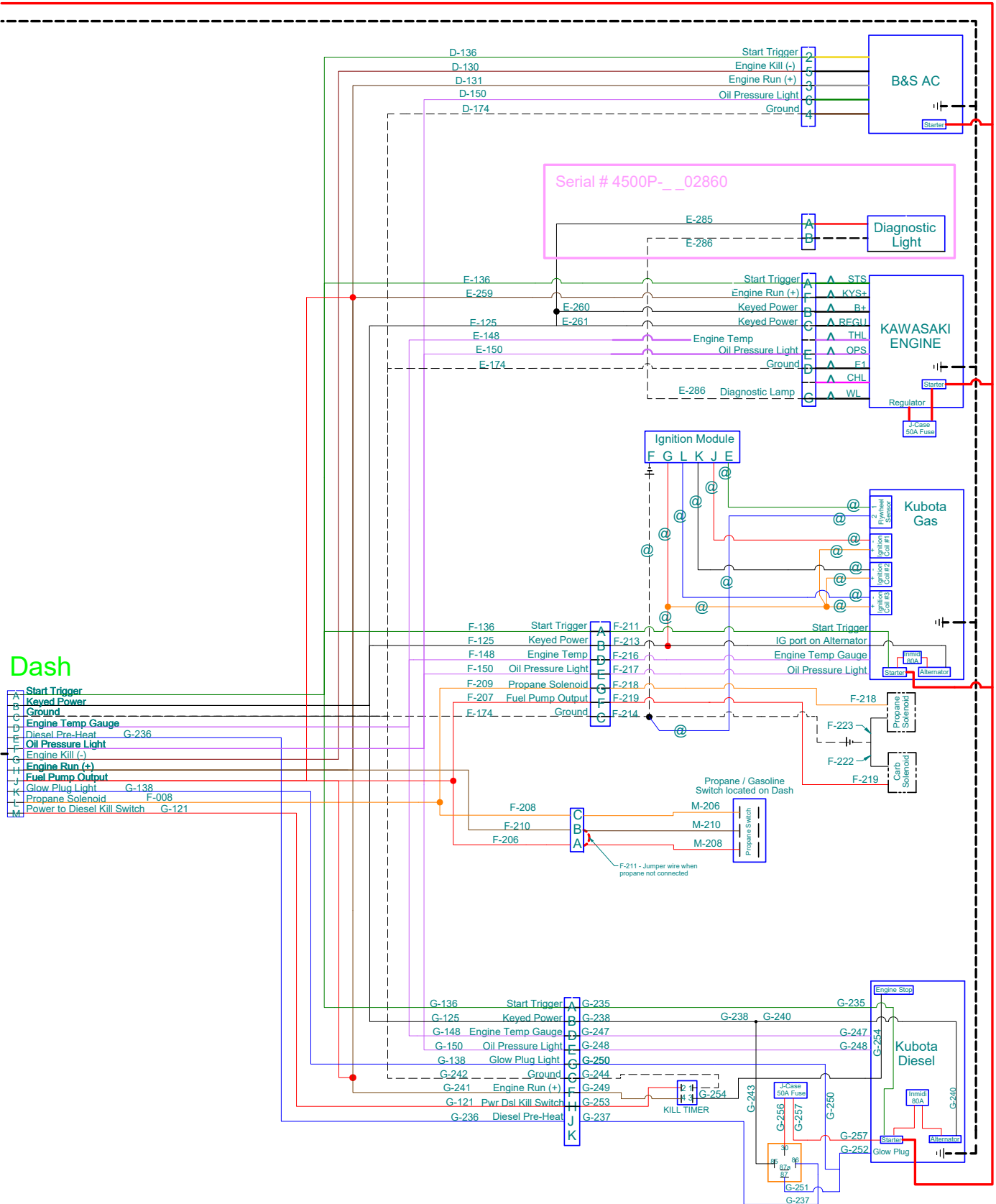

# TROUBLESHOOTING

## Wiring Diagram - Optional 30.0219 4-Pin Female Socket & 30.0218 4-Pin Male Plug



### Attention

This connector (4-pin socket) is designed for use with Ventrac original equipment only. This connector (4-pin socket) is rated for 20 amp maximum current draw. Engine alternator and/or battery capacity determine allowable continuous draw.

**30.0219 4-pin female socket is used in the 70.4104 12 Volt Front kit & 70.4105 12 Volt Rear Kit.**

**Front View of Socket  
Without Cover**

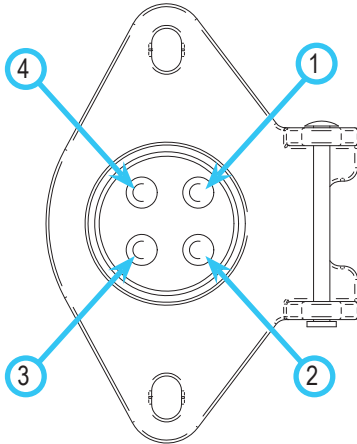

**Rear View of Socket**

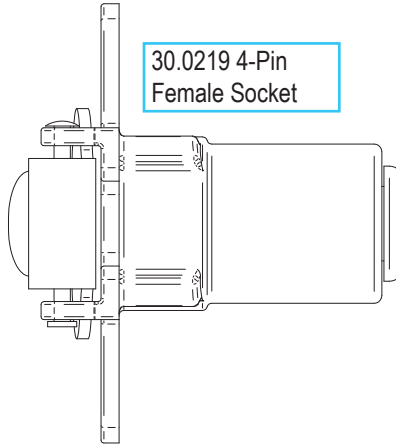
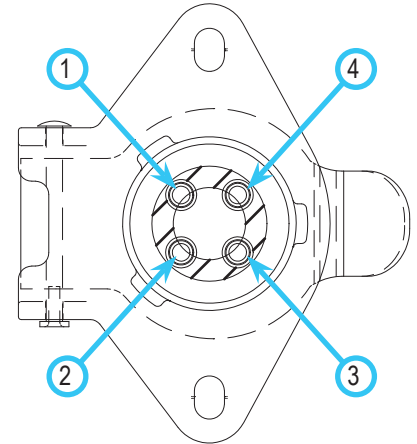

Terminal Position	Wire Color	Function
1	White	Positive (On/Off Switched)
2	Black	Negative (Constant)
3	Red	Positive/Negative (Momentary Switched Reversing)
4	Green or Brown	Positive/Negative (Momentary Switched Reversing)

**30.0218 4-pin plug is used on attachments to connect to the 30.0219 socket on the power unit.**

**Front View of Plug**

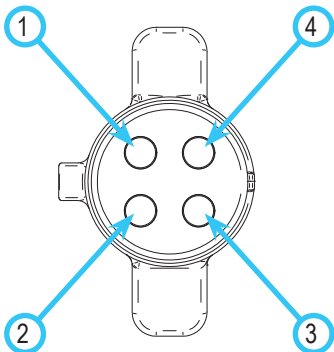

**Rear View of Plug**

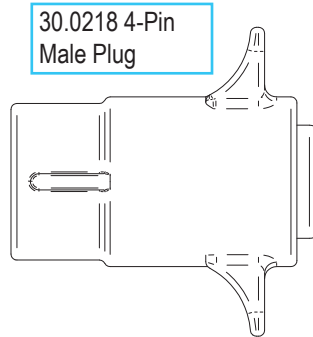
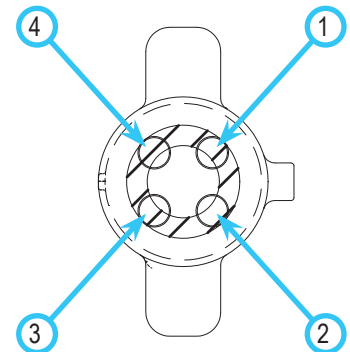

Terminal Position	Wire Color	Function
1	Not Specified*	Positive (On/Off Switched)
2	Not Specified*	Negative (Constant)
3	Not Specified*	Positive/Negative (Momentary Switched Reversing)
4	Not Specified*	Positive/Negative (Momentary Switched Reversing)

\* Refer to the part diagram in the attachment's operator's manual for specific wire color and terminal position for each model.

# TROUBLESHOOTING

## Electrical Troubleshooting Using The Tractor Control Module (TCM)

The TCM monitors the electronic circuits necessary for the engine, starter, and PTO to function. These “input” circuits include the PTO Switch, Neutral Switch, Parking Brake Switch, Key Switch, Seat Switch, and Generator Presence. The TCM is programmed to allow the engine, starter, or PTO to operate only when specific input criteria are satisfied. The engine, start, and PTO circuits are controlled by “outputs” from the TCM.

For troubleshooting purposes, the TCM includes red LED lights for each circuit. The LED lights will activate when the input or output circuit is activated. The TCM is divided into two sections: the left (input) side displays the 8 inputs with red LED lights; the right (output) side displays the 5 outputs also with red LED lights. The TCM has two power supplies. The first supplies powers to the computer independent of the key switch so that the TCM does not turn on and off with each key switch on & off cycle. (Note: When the battery disconnect switch is turned to Off, the TCM is also turned off). The second supply energizes the rest of the computer when the key switch is turned on.

When the battery disconnect switch is turned on, the Power LED light (J) will illuminate. If the system voltage drops below a preset value when the key switch is off, or if the power unit sits unused for more than 15 days, the TCM will automatically go to ‘Sleep’ mode and enter a reduced power state. To ‘Wake’ the TCM, turn the battery disconnect switch off for 10 seconds and then back on.

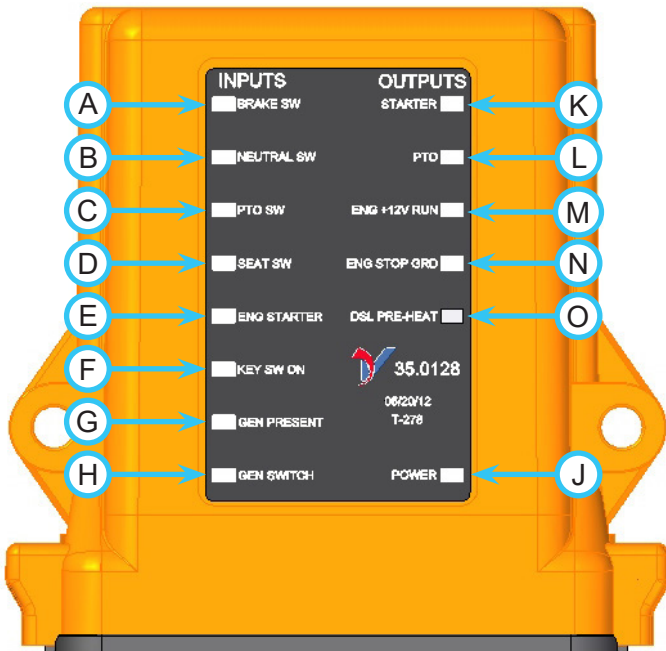

## Input Circuits

### Brake Switch (A)

The light indicates the circuit is closed and the parking brake is engaged. In order for this light to operate, the key switch must be in the On position.

### Neutral Switch (B)

The light indicates the circuit is closed and the power unit's forward/reverse control is in neutral. In order for this light to operate, the key switch must be in the On position and the forward/reverse control (SDLA) must be in the neutral position.

### PTO Switch (C)

The light indicates the PTO switch is in the On position. In order for this light to operate, the key switch must be in the On position and the PTO switch must be in the On (engaged) position.

### Seat Switch (D)

The light indicates that an operator is present in the seat. In order for this light to operate, the key switch must be in the On position and the operator must be present in the seat.

### Engine Starter (E)

The light indicates that the key switch is turned to the Start position.

### Key Switch On (F)

The light indicates that the key switch is turned to the On position. The key switch must be in the On position for the TCM to activate.

### Generator Present (G)

Not applicable.

### Generator Switch (H)

Not applicable.

### Power (J)

This light is located at the bottom right corner of the TCM. This light indicates that there is full time power to the TCM and is only shut off by the battery disconnect switch or if the TCM enters the ‘Sleep’ mode. It keeps the TCM computer energized to eliminate the delay that would otherwise be present when the key switch is first turned to the On position.

# TROUBLESHOOTING

---

## Output Circuits

Specific input conditions must be satisfied before each output circuit can function.

### Starter (K)

The light indicates that power is being sent to the starter solenoid. For the starter output to function, the parking brake must be set and the power unit's forward/reverse control must be in neutral.

### PTO (L)

The light indicates that power is being sent to the PTO clutch relay. For the PTO output to function, the operator must be on the seat.

If the PTO remote kit is installed and an attachment such as the generator is connected, the TCM will automatically enable the Remote PTO function. In this mode the PTO switch on the generator replaces the seat switch criteria for the PTO to function. The parking brake must be engaged for the Remote PTO to function.

The following engine commands are engine specific.

### Engine +12V Run (M)

This light indicates that power is being sent to the engine control module in order for the engine to run. For this light to operate, either the operator must be sitting on the seat, or the parking brake must be engaged and the forward/reverse control (SDLA) must be in the neutral position.

### Engine Stop Ground (N)

Not applicable.

### Diesel Pre-Heat (O)



















Not applicable.

This output is specific for the diesel engine on the 4500Y. It controls the signal that activates and deactivates the glow plugs.

# TROUBLESHOOTING

## Electrical Troubleshooting Guide

1. Always ensure that there is power supplied to the computer (TCM). With the key switch in the Off position, check to ensure the LED light for the Power input (J) is turned on. If the light is not on:
  - a. Check the battery disconnect switch to ensure it is turned on.
  - b. If the battery disconnect switch was already turned on, the TCM may be in 'Sleep' mode. Turn the battery disconnect switch off for 10 seconds and then back on to 'Wake' the TCM.
  - c. Check the 15 amp fuse in slot #10 of the front fuse panel. Replace this fuse, if necessary.
2. Turn the key switch to the On position and check to see if any of the other lights turn on. If no other lights turn on, check the 5 amp fuse in slot #8 of the front fuse panel. Replace this fuse, if necessary. If any other lights turn on, you can start troubleshooting the rest of the TCM functions.
3. To troubleshoot the circuits in the chart below, the corresponding LED lights must be 'On' for the circuit to function. If any of the required LED lights are not on, refer to the troubleshooting section in the following pages.

Circuit	Power	Brake Switch	Neutral Switch	PTO Switch	Seat Switch	Engine Starter	Key Switch
<b>Starter</b>							
<b>PTO</b>							
<b>Engine +12V Run w/o Operator</b>							
<b>Engine +12V Run w/Operator</b>							
<b>DSL Pre-Heat*</b>						 <sup>2</sup>	 <sup>1</sup>

\* Diesel engines only

<sup>1</sup> Turns on when the key switch is turned to the Run position. Remains on for 6 seconds.

<sup>2</sup> Turns on when starter is engaged. Remains on for 5 seconds after the engine starts and the key switch is released and returns to the Run position.

# TROUBLESHOOTING

## Engine

Symptom:	Possible Cause:
Starter will not engage.	Battery disconnect switch in Off position. Tractor Control Module (TCM) is in 'Sleep' mode. Blown fuse in power relay module. Blown fuse in start circuit. Parking brake is not engaged. Parking brake switch is out of adjustment. Power unit not in neutral. Neutral switch is out of adjustment. Low battery voltage.
Engine cranks, but won't start.	Fuel shut-off valve is turned off. Insufficient fuel level. Faulty fuel pump. Plugged fuel filters. Obstruction in the fuel line. Poor engine compression.
Engine runs rough.	Plugged or partially plugged air filters. Plugged or partially plugged fuel filters. Stale, dirty fuel OR wrong seasonal fuel mixture. Insufficient fuel level. Faulty spark plugs. Moisture in spark plug pockets. Faulty fuel pump. Dirty or faulty fuel injectors. Incorrect valve clearance. Valve seat failure.
Engine low on power.	Plugged or partially plugged air filters. Plugged or partially plugged fuel filters. Dirty or faulty fuel injectors. Low cylinder compression.
Engine overheats.	Dirty radiator screen. Low coolant level. Debris in engine compartment. Defective radiator cap. Defective thermostat. Loose alternator fan belt. Blown head gasket.
Oil light comes on when running.	Low oil level. Faulty oil sender. Faulty or plugged oil pump.
Engine emits white smoke.	Low engine temperature. Faulty head gasket. Water in combustion chamber.

# TROUBLESHOOTING

## Engine (Continued)

Symptom:	Possible Cause:
Excessive fuel consumption.	Plugged or restricted air filters or hose. Dirty or faulty fuel injectors.
Engine uses excessive oil.	Check for leaks. Incorrect oil viscosity. Plugged or restricted air filters and or hose. Worn rings or cylinder walls. Worn or faulty valves.

## Electrical

Anytime there is an electrical issue, first check to ensure the LED light for the Power input (bottom right corner) of the TCM is turned on when the key switch is in the Off position. If the light is not on:

- a. Check the battery disconnect switch to ensure it is turned on.
- b. If the battery disconnect switch was already turned on, the TCM may be in 'Sleep' mode. Turn the battery disconnect switch off for 10 seconds and then back on to 'Wake' the TCM.
- c. Check the 15 amp fuse in slot #10 of the front fuse panel. Replace this fuse, if necessary.

Next, turn the key switch to the On position and check to see if any of the other lights turn on. If no other lights turn on, check the 5 amp fuse in slot #8 of the front fuse panel. If any other lights turn on, you can start troubleshooting the rest of the TCM functions.

Symptom:	Possible Cause:
Battery does not charge.	Loose or corroded connections. Broken or loose wire in charge system. Blown fuse or fuse link in charge system. Defective battery. Loose alternator belt. Defective regulator. Defective alternator.
Lights do not activate.	Blown fuse. Blown light bulb. Broken wire. Defective light switch.
PTO does not engage.	Blown fuse. Faulty seat switch. (Operator must be in seat). Faulty PTO switch. PTO belt failure. Clutch air gap out of adjustment. Faulty clutch.
All TCM lights are on, even with key switch off.	Low battery voltage.



# TROUBLESHOOTING

## Hydraulic

Symptom:	Possible Cause:
Front attachment does not lift.	Hydraulic oil level is low. Excessive load on front lift. Plugged hydraulic oil suction filter. Faulty hydraulic cylinder. Pump charge pressure is low. Hardware missing on lift cylinder. Hardware missing on SDLA lever links.
Steering is difficult.	Hydraulic oil level is low. Plugged hydraulic oil suction filter. Faulty steering cylinder. Pump charge pressure is low. Excessive load on hydraulic system.
Excessive noise in hydraulic system.	Hydraulic oil level is low. Plugged hydraulic oil suction filter. Wrong oil used in hydraulic system. Cold weather - allow power unit to warm up.
Hydraulic system overheats.	Tripped circuit breaker for hydraulic cooling fan. Dirty/plugged hydraulic cooler. Faulty cooling fan temperature sender. Faulty cooling fan. Overstressing the hydraulic system (using high range instead of low range for heavy work loads).

## Power Unit

Symptom:	Possible Cause:
Power unit will not move with engine running.	High/low shift lever in the neutral position. Hydraulic oil level is low. Brake not releasing. Pump control arm connecting linkage loose or off. Tow valve bypassing at hydraulic pump. Universal joint at the engine/hydraulic pump is loose. Faulty hydraulic pump or motor.
Engine stalls whenever the SDLA control lever is moved forward or backward out of neutral.	Parking brake switch or neutral switch out of adjustment.

# SPECIFICATIONS

---

## Engine

Model . . . . .	4500P
Manufacturer . . . . .	Kawasaki
Model Number. . . . .	.FD851D
Type . . . . .	Gasoline
Cylinders. . . . .	2
Displacement . . . . .	824 cc
Engine Gross Power . . . . .	31 Hp (23.1 kW)
Operating Range (RPM). . . . .	.1550-3600
Cooling System . . . . .	Liquid Cooled
Alternator. . . . .	.30 Amp

## Electrical

Battery. . . . .	500 Cold Cranking Amps
Voltage . . . . .	.12 Volts

## Power Train

Type . . . . .	Hydrostatic (All Wheel Drive)
Hydrostatic Transaxle (2) . . . . .	Peerless
Fwd Speed (High)* . . . . .	.10 mph (16.1 kph)
Fwd Speed (Low)* . . . . .	.5.2 mph (8.4 kph)
Brakes. . . . .	.Hydro-Dynamic
Hydraulic Oil Filtration. . . . .	.10 Micron & 25 Micron

## Controls & Instrument Panel

Steering . . . . .	Power
PTO (Power Take Off). . . . .	.Electric w/brake
Throttle Control . . . . .	.Cable
Directional Control . . . . .	.Speed, Direction, Lift, Auxiliary (S.D.L.A)
Control Orientation . . . . .	.Hand
Gauges . . . . .	Tachometer, Volt, Water Temperature, Fuel, Speedometer
Parking/Emergency Brake . . . . .	Band Brake

## Other Features

Turning Radius . . . . .	39" (99 cm)
Standard Tires. . . . .	.All Terrain (22 x 12-8) (56 x 30-20 cm)
Optional Tires . . . . .	.Turf (22 x 11-10) (56 x 28-26 cm)
Optional Tires . . . . .	Bar (21 x 11-8) (53 x 28-20 cm)
Headlight. . . . .	.Halogen (55 watt)
Attachment System. . . . .	.Ventrac Mount

\* May vary based on tire size, type, and inflation.

# SPECIFICATIONS

## Dimensions

Wheelbase . . . . .	. 45" (114 cm)
Overall Length. . . . .	. 82" (208 cm)
Overall Height (top of ROPS bar) . . . . .	. 67" (170 cm)
Overall Width (single tires)*. . . . .	. 48" (122 cm)
Overall Width (dual tires)* . . . . .	. 73" (185 cm)
Weight** . . . . .	1,340-1,680 lbs. (610-760 kg)

Venture Products, Inc. reserves the right to change these specifications without notice.

\* May vary based on tire size, type, and inflation.

\*\* Weight varies based on engine size, tire options, and optional accessories.

## Fluid Capacities & Specifications

	Fluid Type	Capacity	Filter #1	Filter #2
Engine Oil	Synthetic 10W-30 <sup>§</sup>	2.0 quarts (1.9 liters)	13.0268	-
Hydraulic Oil (Front Transaxle & Reservoir)	HydroTorq XL Synthetic Hydraulic Oil	12.1 quarts (11.5 liters) Opt. 3-point hitch 12.8 quarts (12.1 liters)	21.0122 (Suction filter)	21.0124 (Return filter)
Hydraulic Oil (Rear Transaxle)	HydroTorq XL Synthetic Hydraulic Oil	4.6 quarts (4.4 liters)	-	-
Cooling System	50% distilled water and 50% ethylene glycol antifreeze <sup>^</sup>	7 quarts (6.6 liters)	-	-
Fuel System	Unleaded Gasoline (Max 10% Ethanol)	6 gallons (22.7 liters)	13.0053	-
Grease	Lithium Complex NLGI #2	Refer to Maintenance Chart	-	-

<sup>§</sup> = use API Classification SH, SJ, or higher

<sup>^</sup>Recommended antifreeze: a low silicate, phosphate free antifreeze (ethylene glycol) containing supplemental coolant additives (SCA's) to inhibit corrosion and rust.

**Attention: Engine Oil Recommendation**

For optimal engine life and performance, use Ventrac Full Synthetic Engine Oil.  
**Part # 15.0037-1**



Visit [ventrac.com/manuals](http://ventrac.com/manuals) for the latest version of this operator's manual.

A downloadable parts manual is also available.



# SPECIFICATIONS

## Amperage Draw Chart

Stockcode	Component Description	Amperage
	4500P Tractor (General Amp Draw)	2.9
	Fuel Pump	0.9
	Lights	9.2
37.0060	PTO Clutch	6.1
21.0121	Hydraulic Cooler Fan	4.8

### Options

70.4113	Halogen Work Light Kit	9.2
70.4133	LED Work Light Kit	2.6
70.4114	Strobe Light Kit	0.2
70.4155	Strobe Light Kit	0.35
70.4119	Directional / Hazard Signal Kit	0.6
70.4156	ECE Directional / Hazard Signal Kit	2.0
70.4104	12 Volt Front Kit	Determined by Attachment
70.4105	12 Volt Rear Kit	Determined by Attachment
70.4112	Slope Indicator Kit	0.1
70.4140	Slope Indicator Kit	0.5
70.4101	Back-Up Alarm Kit	0.0

### Weather Cab

70.2009	KW450 Weather Cab (Work Lights On, Windshield Wiper On)	7.1
70.2005-2	Direction Signal / Flasher Kit	8.0
70.2006-3	Strobe Light Kit	0.2
70.2006-6	Defrost Fan Kit	2.0 / 3.1
70.2009-52	Heater Kit - Kawasaki Engine (Fan on High)	8.5
70.2014	KW452 Weather Cab (Work Lights On, Windshield Wiper On)	8.9
	Heater Fan Low / Medium / High	5.4 / 7.4 / 12.6
70.2006-6	Defrost Fan Kit	2.0 / 3.1
70.8148	Windshield Washer Kit	4.0
70.8161	Strobe Light Kit	0.35
70.8162	Hazard Light Kit	0.88

### Attachments

70.8015	EA Seeder Kit (EA600 AeraVator)	5.3
70.8025	12 Volt Actuator Kit (HB580 Broom, KX523 Snowblower)	0.8
23.0136-1	Directional Control Valve (KV550, KV552)	1.8
70.8035	Height Adjust Cylinder Kit (KR502, KR702)	3.6
39.55500	ES220 Spyker Spreader	8.0
70.2010	SS575 Salt Spreader	5.0
70.8120	SS575 Vibrator Kit	8.2
70.2013	SA250 Drop Spreader	12.0
39.55170	MA900 Boom Mower	10.8

# SPECIFICATIONS

## Belt Chart

4500 Power Unit	Belt Size	Ventrac Part Number
4500 PTO Belt (Clutch to PTO Idler Pulley)	B38 belt	81.B038

Attachment Model	Belt Size	Ventrac Part Number
EA600 AERA-vator	B50 Belt	81.B050
ED202 Edger (with Blower)	B45 Belt	81.B045
ET200 Turbine Blower	B46 Belt	81.B046
HB580 Broom	B48 Belt	81.B048
HM722 Mower	B45 Belt	81.B045
HQ680 Tough Cut Mower	B45 Belt	81.B045
KA160 Power Blower	B52 Belt	81.B052
KC180 Stump Grinder	B53 Belt	81.B053
KL480 Tiller	B66 Belt	81.B066
KP540 Power Rake	B48 Belt	81.B048
KX523 Snow Blower	B50 Belt	81.B050
KY400 Trencher	B53 Belt	81.B053
MA900 Boom Mower	B49 Belt	81.B049
MC600 Rear Discharge Mower	B47 Belt	81.B047
MJ840 Contour Mower	B45 Belt	81.B045
MR740 Reel Mower	B47 Belt	81.B047
MS600 Mower	B45 Belt	81.B045
MU720 Rear Discharge Mower	B45 Belt	81.B045

## Noise Emissions

1,2

Power Unit	4500P				
Mower Attachment	Power Unit Only	MS600	MU720	MJ840	MR740
Measured Sound Power Level, dB(A)	98.0	104.0	103.7	103.9	100.7
Uncertainty, dB(A)	2	0.8	0.8	0.6	2
Sound Pressure Level at Operator's Ear, dB(A)	85.2	90.3	90.0	87.6	85.0
Uncertainty, dB(A)	2	2	2	2	2

Note 1: Noise emissions determined per EN ISO 5395-1.

Note 2: Specifications subject to change without notice.

# SPECIFICATIONS

## Vibration Levels

1,2

Power Unit	4500P				
Mower Attachment	Power Unit Only	MS600	MU720	MJ840	MR740
Hand-Arm Vibration (m/s <sup>2</sup> )	<2.5	2.82	2.82	<2.5	<2.5
Uncertainty (m/s <sup>2</sup> )	1	1	1	1	1
Whole Body Vibration (m/s <sup>2</sup> )	<0.5	<0.5	<0.5	<0.5	<0.5
Uncertainty (m/s <sup>2</sup> )	0.4	0.4	0.4	0.4	0.4

Note 1: Vibration levels determined per EN ISO 5395-1.

Note 2: Specifications subject to change without notice.

## EC Declaration of Conformity Ventrac 4500P

Manufacturer	Venture Products, Inc. 500 Venture Drive Orrville, OH 44667 USA
Authorized Representative (also authorized to compile the technical file)	Lars Persson LAPAB MASKIN AB Box 46, S-734 22 Hallstahammar Flädervägen 5, 734 38 Hallstahammar SWEDEN
Technical File Keeper	Ryan Steiner Venture Products, Inc. 500 Venture Drive Orrville, OH 44667 USA
Description	Multipurpose device with attachment for lawn mowing (>20kW)
Model Name	Ventrac 4500P Power Unit + MS600 Mower Ventrac 4500P Power Unit + MU720 Mower Ventrac 4500P Power Unit + MJ840 Mower Ventrac 4500P Power Unit + MR740 Mower
Model Number	39.51210 + 39.55116 39.51210 + 39.55117 39.51210 + 39.55161 39.51210 + 39.55130
Serial Number	4500P-Axxxxxx + MS600-Bxxxxx 4500P-Axxxxxx + MU720-Bxxxxx 4500P-Axxxxxx + MJ840-Bxxxxx 4500P-Axxxxxx + MR740-Cxxxxx
This Product Conforms to Directives	2006/42/EC 2000/14/EC 2004/108/EC
This Product Conforms to Standards	EN ISO 5395-1 EN ISO 5395-3
Ryan Steiner Director of Engineering 	01-January-2019 Orrville, Ohio USA

# WARRANTY



## LIMITED WARRANTY - VENTRAC COMMERCIAL EQUIPMENT

Venture Products, Inc., (henceforth referred to as V.P.I.) warrants on the terms and conditions herein, that it will repair, replace, or adjust any part manufactured by Venture Products Inc., and found by Venture Products, Inc., to be defective in material and/or workmanship during the applicable warranty term.

All Ventrac commercial equipment purchased and registered on or after January 1, 2019 will carry a 2-year commercial warranty. The warranty period begins on the date of original customer purchase:

<b>Ventrac Commercial Equipment</b>	<b>Warranty Term</b>
2100 SSV & Attachments	2-year
3000 Series Tractors & Attachments	2-year
4000 Series Tractors & Attachments	2-year

All Ventrac add-on kits and accessories such as: 3-point hitch, 12V front & rear power outlets, foot pedal, dual wheel kit, etc., will be covered under the above warranty periods provided they are installed by an Authorized Ventrac Dealer. This warranty may be transferred and will carry the remainder of the warranty starting from the original purchase/registration date with the dealership and/or V.P.I.

The engine warranty is covered by its respective engine manufacturer. Please refer to the engine manufacturer's warranty statement that is included in the owner's manual.

For warranty consideration on Ventrac commercial equipment, including any defective part, must be returned to an Authorized Ventrac Dealer within the warranty period. The warranty shall extend to the cost to repair or replace (as determined by V.P.I.) the defective part. The expense of pickup and delivery of equipment, service call drive time or any transportation expense incurred for warranty repair is the sole responsibility of the owner and is not covered under warranty by Ventrac and/or V.P.I. Ventrac and V.P.I.'s responsibility in respect to claims is limited to making the required repairs or replacements, and no claim of breach of warranty shall be cause for cancellation or rescission of the contract of sale of any Ventrac equipment. Proof of purchase may be required by the dealer to substantiate any warranty claim. Only warranty work performed and submitted by an Authorized Ventrac Dealer may be eligible for warranty credit.

This warranty extends only to Ventrac commercial equipment operated under normal conditions and properly serviced and maintained. The warranty expressly does NOT cover: (a) any defects, damage or deterioration due to normal use, wear and tear, or exposure; (b) normal maintenance services, such as cleaning, lubrication, oil change; (c) replacement of service items, such as oil, lubricants, spark plugs, belts, rubber hoses, bearings or other items subject to normal service replacement; (d) damage or defects arising out of, or relating to abuse, misuse, neglect, alteration, negligence or accident; (e) repair or replacement arising from operation of, or use of the equipment which is not in accordance with operating instructions as specified in the operator's manual or other operational instructions provided by V.P.I.; (f) repair or replacement arising as a result of any operation from Ventrac equipment that has been altered or modified so as to, in the determination of V.P.I., adversely affect the operation, performance or durability of the equipment or that has altered, modified or affected the equipment so as to change the intended use of the product; (g) repair or replacement necessitated by the use of parts, accessories or supplies, including gasoline, oil or lubricants, incompatible with the equipment or other than as recommended in the operator's manual or other operational instructions provided by V.P.I.; (h) repairs or replacements resulting from parts or accessories which have adversely affected the operation, performance or durability of the equipment; or (i) damage or defects due to or arising out of repair of Ventrac equipment by person or persons other than an authorized Ventrac service dealer or the installation of parts other than genuine Ventrac parts or Ventrac recommended parts.

# WARRANTY

---



## LIMITED WARRANTY - VENTRAC COMMERCIAL EQUIPMENT

The sole liability of V.P.I. with respect to this warranty shall be the repair and replacement as set forth herein. V.P.I. shall have no liability for any other cost, loss, or damage. In particular V.P.I. shall have no liability or responsibility for: (i) expenses relating to gasoline, oil, lubricants; (ii) loss, cost or expense relating to transportation or delivery of turf equipment from the location of owner or location where used by owner to or from any Authorized Ventrac Dealer; (iii) travel time, overtime, after hours' time or other extraordinary repair charges or charge relating to repairs or replacements outside of normal business hours at the place of business of an Authorized Ventrac Dealer; (iv) rental of like or similar replacement equipment during the period of any warranty repair or replacement work; (v) any telephone or telegram charges; (vi) loss or damage to person or property other than that covered by the terms of this warranty; (vii) any claims for lost revenue, lost profit or additional cost or expense incurred as a result of a claim of breach of warranty; or (viii) attorney's fees.

The remedies of buyer set forth herein are exclusive and are in lieu of all other remedies. The liability of V.P.I., whether in contract, tort, under any warranty, or otherwise, shall not extend beyond its obligation as set forth herein. V.P.I. shall not be liable for cost of removal or installation nor shall V.P.I. be responsible for any direct, indirect, special or consequential damages of any nature. In no event shall V.P.I. be liable for any sum in excess of the price received for the goods for which liability is claimed.

There are no representations or warranties which have been authorized to the buyer of the Ventrac commercial equipment other than set forth in this warranty. Any and all statements or representations made by any seller of this equipment, including those set forth in any sales literature or made orally by any sales representative, are superseded by the terms of this warranty. Any affirmation of fact or promise made by V.P.I. or any of its representatives to the buyer which relates to the goods that are the subject to this warranty shall not be regarded as part of the basis of the bargain and shall not be deemed to create any express warranty that such goods shall conform to the affirmation or promise.

No employee, distributor, or representative is authorized to change the foregoing warranties in any way or grant any other warranty on behalf of V.P.I.

Some states do not allow limitations on how long an implied warranty lasts or allow the exclusion on limitation of incidental or consequential damages, so the above limitation or exclusion may not apply to you.

This warranty gives you specific legal rights, and you may also have other rights which vary from state to state.

This warranty applies to all Ventrac commercial equipment sold by Venture Products Inc.