

OWNER'S MANUAL



PACKS THE BIGGEST PUNCH

Read and understand this entire manual before riding. Thumpstar Motorbikes strongly recommend having this machine assembled by a skilled mechanic. Assembly should include, but is not limited to checking over the entire bike including the engine.

GENUINE THUMPSTAR

X3 VERSION

TSF 150-X

TSF 170-X

TSF 189-X

TSF 230-X

TSF 250-X

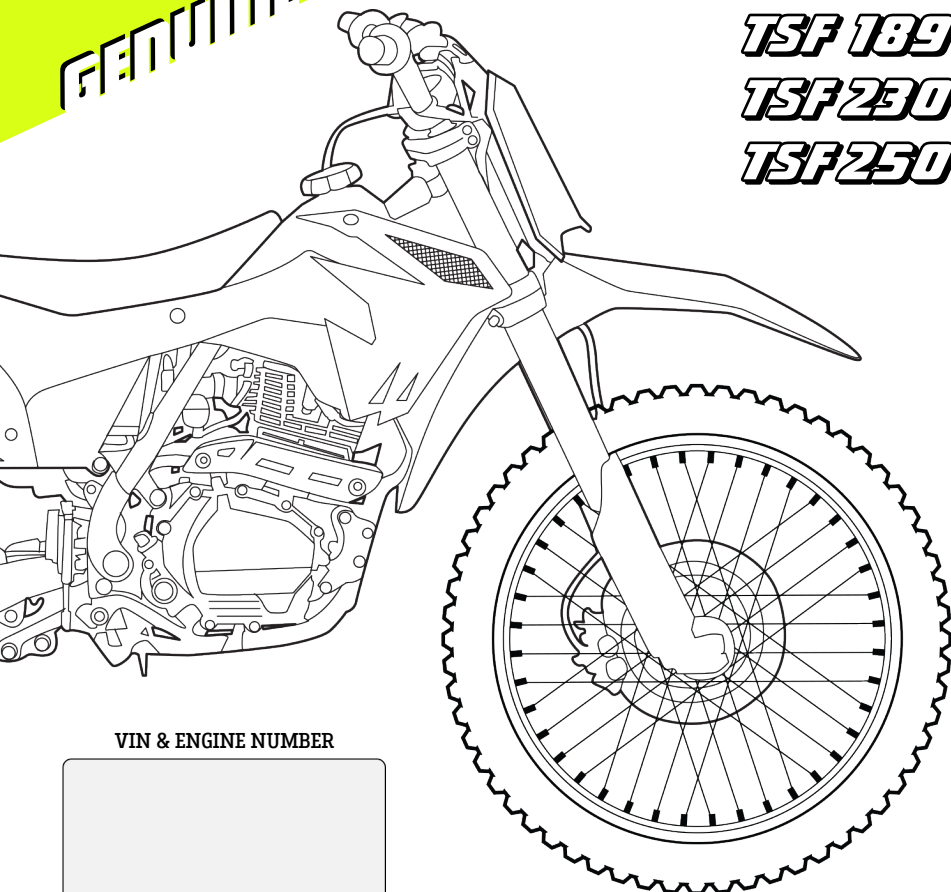

VIN & ENGINE NUMBER

NOTE:

Manual illustrations are for demonstration purposes only. Illustrations may not reflect exact appearance of actual product. Specifications subjected to change without notice.

 /thumpstarmoto
 /genuinethumpstar

MANUAL # 7899

REV0922

Owner's Manual

TSF 150-X_{X3}

TSF 170-X_{X3}

TSF 189-X_{X3}

TSF 230-X_{X3}

TSF 250-X_{X3}

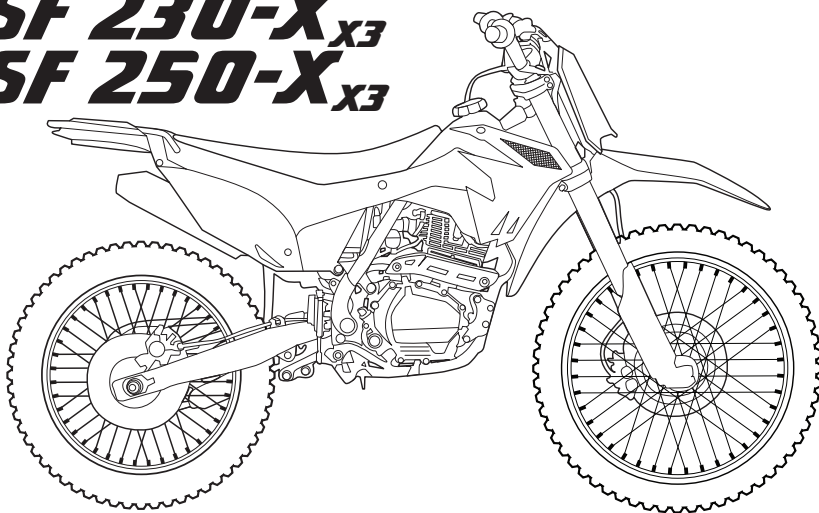

FOR OFF-ROAD USE ONLY

This motorcycle is designed and manufactured for competition use in sanctioned closed-course event.

This manual should be considered a permanent part of the motorcycle and should remain with the motorcycle when it is resold.

Thumpstar reserves the right to make changes at any time without notice and without incurring any obligation.

This publication includes the latest production information available before printing.

No part of this publication may be reproduced without written permission.

This motorcycle pictured in this owner's manual may not match your actual motorcycle.

Contents

These pages give an overview of the contents of your owner's manual	
Quick Reference	1
Introduction	2
Motorcycle Assembly	3
A Few Words About Safety	6
Motorcycle Safety	7
<i>Exhaust System</i>	9
<i>Fuel Handling</i>	9
<i>Safety Equipment</i>	10
Message To Riders	12
Loading, Accessories & Modifications	14
Safety Labels	16
Operating Controls	17
<i>Operation Component Locations</i>	17
<i>Fuel Valve</i>	18
<i>Choke Knob</i>	19
Before Riding	20
Protective Gears	21
Is Your Motorcycle Ready	22
Pre-Ride Inspection	23
Basic Operation & Riding	25
Starting & Stopping the Engine	26
Shifting Gears	28
Braking	30
Parking	31
The Importance of your Maintenance	32
Maintenance Safety	34
Maintenance Schedule	35
Maintenance	38
<i>Front & Rear Brakes</i>	38
<i>Fuel Line and Tank</i>	38
<i>Oil Levels</i>	38
<i>Replacing the Oil</i>	39
<i>Air Filter</i>	39
<i>Throttle</i>	40
<i>Chain</i>	40

Contents

<i>Tires</i>	41
<i>General Cleanliness</i>	41
Wiring Diagram	42
Fuel	43
Engine Oil	45
Carburetor Adjustment & Tuning Tips	49
Air Cleaner	54
<i>Cleaning</i>	55
Throttle	56
Clutch System	59
Valve Clearance	61
Engine Idle Speed	63
Component Inspection	64
<i>Spark Plug</i>	64
<i>Suspension</i>	67
<i>Brakes</i>	69
<i>Wheels</i>	72
<i>Side Stand</i>	76
<i>Tires & Tubes</i>	77
<i>Drive Chain</i>	81
Appearance Care	86
Preparing for a Ride	87
Transporting your Thumpstar	88
Storing your Thumpstar	89
Troubleshooting	91
You & the Environment	94
Taking Care of the Unexpected	95
Vehicle Identification	99
Oxygenated Fuels	100
Specification	101
Spare Part Catalogue	106
Torque Settings	121
Parts Finder	126
Warranty	127
Disclaimer	128
Service Manual	129
Title Ownership	130

Quick Reference

Model Version	150-X X3	230-X X3	250-X X3
Oil	6.3L		
Spark Plug	GNCPR6E		D8TC
Tire Pressure	20 PSI Front / 20 PSI Rear		
Tire Size	Front 70/100-17 Rear 90/100-14	Front 80/100-19 Rear 110/90-16	Front 80/100-21 Rear 110/90-18
Valve Clearance	2" intake / 4" exhaust		.003" intake / .005" exhaust
Chain	520 Chains		
Air Filter	BSE 150		
Handle Bar	800-810 Fat Handlebar		
Wheel Bearings	6302/6005		
Swingarm Bearings	6002		
Engine Mount	TBA		
Plastics	BSE 150		
Brake Pad Front	TBA		
Brake Pad Rear	250		
Clutch Cable	950+150		950+180
Throttle Cable	950+122		

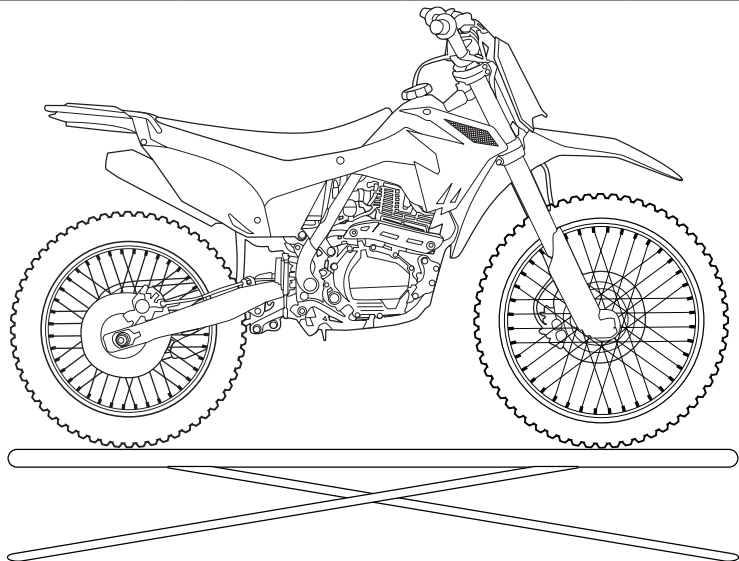

Congratulations in your decision to purchase a Genuine Thumpstar Dirt bike. The following manual has been prepared to familiarise you with your motorcycle, and the procedures involved with operating and maintaining the motorcycle.

This manual also outlines general safety recommendations. We strongly advise that you take safety in mind at all times when maintaining and operating your dirt bike.

Thumpstar condone safe riding and do not take any responsibility for any damages caused to any persons or property due to inappropriate riding and safety precautions. Thumpstar Strongly recommends reading this manual thoroughly BEFORE attempting any assembly or operation of the bike. Thumpstar Strongly recommends the use of the correct safety gear and safety procedures.

Warning: Thumpstar only recommend riding privately on closed course tracks by experienced riders and is not for general offroad recreational use, before riding anywhere other than on private land. Thumpstar advise contacting your local road authority for further information, laws and restrictions.

Please note: Thumpstar produce a range of dirt bikes, some photographs and diagrams specific to component parts may differ slightly from the model you have purchased/received. If in doubt at any point, please contact a qualified mechanic or contact us for support.

Whenever you ride, tread lightly. By only racing in private closed course tracks and approved riding areas, you help protect the environment and keep off-road riding areas open for the future.

Please report any change of address or ownership to your dealer so we will be able to contact you concerning important product information.

HAPPY RIDING!

Always have a Qualified Mechanic Assemble Your New Motorcycle

Tools Required:

- Bike Stand
- Lifting Jack
- 8, 10, 12, 13, 14, 17, 19mm socket and spanner
- 5, 6mm Allen Key/Hex Tool
- Rubber Mallet
- WD 40
- Lubricant
- Grease
- Paint Pen
- Thread Lock Glue
- Zip Tie
- Tire Pressure Gauge

Tick box once task has been completed

Remove Bike & all accessories from crate

Install handlebars and route cables and front brake hose before installing fork

Front brake hose(1) should be at front, then throttle cable(2), clutch cable(3), last the kill switch wire(4)

The longer front wheel (1) spacer will always be installed on the left/disc side (**page 72**)

Fork Standard setting is 10mm out of clamp but depending on rider preference, use copper grease on triple clamp bolts to prevent damage to the alloy threads & then firmly tighten.

Use thread lock compound on front brake calliper bolts and torque to 9.9 N.M Pump front brake lever until firm (bleed if necessary). Check front braking system for potential leaks or damage by pulling brake lever very hard several times. Visually inspect all joints for leaks

Grease front axel - Recommend using "Anti Seize Grease" (**page 72**)

Front wheel should spin freely, spin wheel to ensure calliper is releasing from disk (**page 69**)

- Test rear brake pedal & repeat procedure described for front brake (*page 69*)
- Check fluid levels, top up with DOT4 where necessary (*page 69*)
- Fit front mudguard and ensure step washer are installed correctly.
- Fit foot pegs and use grease on foot peg pins
- Ensure the correct pressure in tires – (*page 77*)
- Loosen rear wheel & adjust chain tension. (*page 81*)
- Working from front to rear, ensure all nuts & bolts are tight. Safety areas: Wheel nuts, brake calliper bolts, Top & rear engine bolts, chain tensioners, rear shock bolts, triple clamp bolts (yokes), Handlebars, brake/clutch/throttle, swing-arm, front & rear sprocket.
- After checking the torque settings (*page 118*), please reference mark each bolt with paint marker. If any bolt does come loose the lines will not line up.
- Ensure nothing is touching the exhaust system.
- Ensure all cables pipes & wiring are away from moving components such as the wheels, use cable/zip ties where necessary
- Fuel bike & check for fuel leaks (*page 38*)
- Check oil level with bike in upright position using dipstick (*page 47*)
- Check throttle and clutch is working correctly with freeplay adjusted correctly (*page 56 & 59*)
- Ensure wheel spokes are tight & wheels run true (*page 72*)
- Inspect bike for any other defects

- Start engine & warm up (using choke if necessary). Set idle speed so engine ticks over comfortably without stalling or racing. (*page 63*)
- Test machine ensuring that all controls are fluid & functional. Ensure brakes are working efficiently (bearing in mind that the pads will need to bed in prior to optimum performance).

Engine break-in

Run bike at no more than three quarter throttle & do not allow engine to rev to a high speed. Engine break-in should be no less than one hour. After one hours carry out the following checks & procedures:

- Drain oil & replace with 950mls quality 10w 30w or 10w 40 4-stroke engine oil (*page 45*)
- Check all nuts & bolts & tighten where necessary (*page 118*)
- Check wheel spokes (especially rear wheel drive side) & tighten where necessary
- Re-Adjust throttle cable & clutch cable if required (*page 56 & 59*)
- Re-tension chain and lubricate
- Check wheel bearings for any sign of wear of free-play
- Check brake calliper operation & brake pad wear (*page 69*)
- Check tire pressures (*page 77*)

Remember to do pre-ride inspection each time you ride (*page 23*)

A Few Words About Safety

Your safety, and the safety of others, is very important. And operating this motorcycle safely is an important responsibility.



DANGER!

You **WILL** be **KILLED** or **SERIOUSLY HURT** if you don't follow instructions.



WARNING!

You **CAN** be **KILLED** or **SERIOUSLY HURT** if you don't follow instructions.



CAUTION!

You **CAN** be **HURT** if you don't follow instructions.



WARNING



Always use an approved helmet & protective gear



Never carry passengers

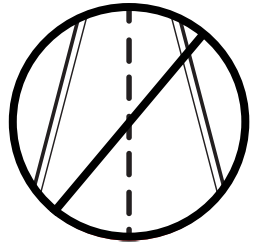

Never use public roads



Never use with drugs or alcohol

This section presents some of the most important information and recommendations to help you ride your motorcycle safely. Please take a few moments to read these pages. This section also includes a special message for parents and location information for the safety labels on your motorcycle.

Thumpstar Motorbikes strongly recommend that anyone considering operating any of our products follow these instructions to avoid serious injury and/or death:

Read this manual carefully and follow the operating procedures described.

Follow the age recommendation of the specific Thumpstar model.

Children under the age of 16 should be supervised by an adult at all times. (Safety is the sole responsibility of parental guardians)

Never operate a bike without wearing an approved motorcycle helmet that fits correctly.

Thumpstar strongly recommends the use of eye protection (goggles and/or face shield), gloves, boots, long-sleeved shirt or jacket, and long pants.

Never consume alcohol or drugs before or while operating any bike.

Never operate at speeds too fast for your skills or the conditions. Always go at a speed that is appropriate for the terrain, visibility and your experience.

Never attempt any kind of stunts

Always inspect your bike before each use to make sure it is in safe operating condition.

Always keep both hands on the handlebars and both feet on the footboards of the dirt bike during operation.

Always be alert to changing conditions of terrain, weather and visibility when operating the bike.

Never operate on excessively rough, slippery or loose terrain.

Always follow proper procedures for turning as described in this manual.

Never attempt to turn the bike around on any slope until you have mastered the turning technique described in this manual on level ground. Avoid crossing the side of a steep slope if possible.

Never attempt to operate over large obstacles, such as large rocks or fallen trees. Always follow proper procedures when operating over obstacles as described in this manual.

*Never operate a bike in fast flowing water
Wet brakes may have reduced operating ability. Test your brakes after contact with water. If necessary, apply them several times to let friction dry out the linings.*

Always use the correct size and type of tires specified in this manual.

Always maintain proper tire pressure as described in this manual.

Never modify any bike through improper installation or use of accessories.

Never exceed the stated load capacity for any Thumpstar Motorbikes product.

Ensure the safe handling of ANY petrochemicals required for the maintenance of your Thumpstar product.

Thumpstar Motorbikes will not be held responsible for violations of local road laws, Thumpstar range of bikes are designed solely for competition use in sanctioned, closed-course events

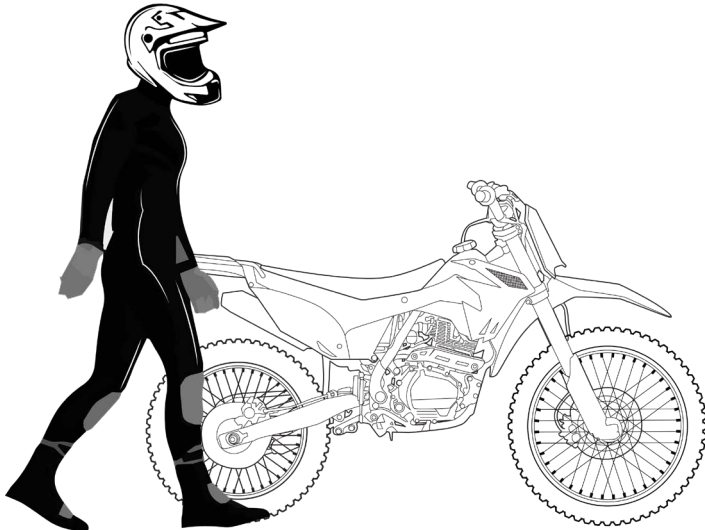

EXHAUST SYSTEM

Thumpstar Motorbikes advise that the exhaust on the machine can become very hot during and following operation. To prevent burns, avoid touching the exhaust system. Park the machine in a place where Pedestrians or children are not likely to come in at contact.

FUEL HANDLING

Precautions should be taken when handling any type of petrochemicals. Gasoline can catch fire, and is toxic to life and the environment. Thumpstar motorbikes recommend the following safety tips to avoid accidents, injury/death:

Always turn off the engine when re-fuelling. Do not refuel right after the engine has been running and is still very hot.

Do not spill gasoline on the engine or exhaust pipe/muffler when refuelling.

When transporting the machine in another motorcycle, be sure it is kept upright and that the fuel cock is in the “OFF” position. Otherwise, fuel may leak out of the Carburetor or fuel tank.

Never refuel in any proximity to any sources of ignition such as smokers, open flames or embers etc.

Gasoline is poisonous and can cause injuries, in the case of swallowing gasoline, inhaling gasoline vapours or contact with eyes, see your doctor immediately.

In the case of gasoline contact on your skin, wash with soap and water. If gasoline spills on your clothing, change your clothes.

SAFETY EQUIPMENT

Thumpstar Motorbikes promote the use of safety equipment during the use of your bike; the following list is an advisory guideline of the equipment that should be obtained before using your bike for the first time, and to be used for every ride regardless of experience and skill level.

HELMET

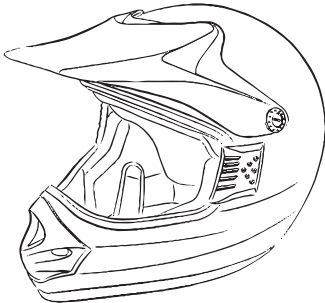

A helmet is the most important piece of protective equipment and should be worn at all times the motorcycle is being ridden.

Select a helmet that complies with the Standard Protective helmets for motorcycle users. These helmets meet the requirements for on-road and off-road use.

Ensure the helmet fits the operator snugly, is securely fastened and provides good, all-round visibility. A poorly-fitting or loose helmet can become dislodged in an incident and then offer no protection at all.

EYE PROTECTION

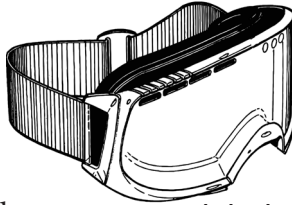

Recommended to prevent eye injuries and prevent branches, bugs, dust or sand hitting your face and distracting you. Sunglasses are unlikely to provide adequate physical protection.

GLOVES

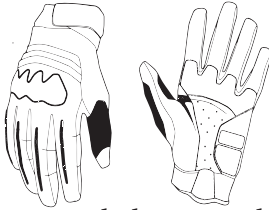

Recommended to provide protection from abrasions and help to keep your hands from getting sore, tired or cold. Note that gloves may become slippery when wet and are not advisable for use

FOOTWEAR

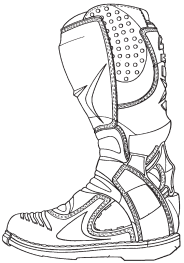

Sturdy footwear is recommended (preferably boots that come up past your ankle with strong material for gear changes.)

CLOTHING

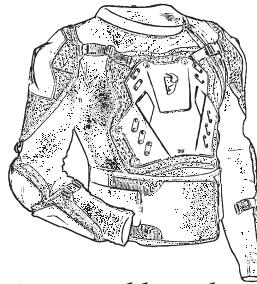

Arms and legs should be covered to reduce abrasions to the body, even in hot weather.

Trousers should be close-fitting and in good condition.

Your safety is very important to Thumpstar. That's why we urge you to read this message before riding this motorcycle. Off-road riding can be fun. But, as with riding a bicycle, bad judgment can result in injury, and we don't want that to happen! You can help prevent accidents by making good decisions about if, when, and how you ride this motorcycle.

THINGS TO CONSIDER WHEN RIDING

The first decision you'll need to make is whether you're ready to ride. Riding readiness varies widely from one person to another, and age and size are not the only factors. Remember this model is designed for experienced riders only.

PHYSICAL ABILITY

An important consideration that riders must be big enough to hold the motorcycle up, get on, and comfortably sit on the seat with both feet touching the ground. They should also be able to easily reach and work the brakes, throttle, and all other controls.

ATHLETIC ABILITY

A necessary trait for riding a motorcycle. Generally speaking, you should be good at riding a bicycle before getting on a motorcycle. Can you judge speeds and distances while riding a bicycle and react with proper hand and foot actions? Anyone who does not have good coordination, balance, and agility is not ready to ride this motorcycle and is not considered an experienced rider.

MENTAL AND EMOTIONAL MATURITY

Do you think through problems and come to logical solutions?
On a bicycle, do you obey safe riding rules? Be honest!
Anyone who makes unnecessary risks, make bad judgments,
and don't obey rules are not ready to ride this motorcycle.

If you decide that you're ready to safely operate this motorcycle,
make sure you carefully read and understand the owner's manual
before riding. Also be sure that you have a helmet and other
appropriate riding equipment, and always wears it when
operating the motorcycle or sitting on it.

SAFE AND RESPONSIBLE RIDING

When you put safety first, you can enjoy more peace of mind, and
you can enjoy more hours of safe offroad riding.

Thumpstar was designed as a rider-only motorcycle. It was not designed to carry a passenger or cargo. A passenger or cargo could interfere with your ability to move around to maintain your balance and control of the motorcycle

In addition, exceeding the weight limits or carrying an unbalanced load can seriously affect your motorcycle's handling, braking, and stability. Adding accessories or making modifications that change this motorcycle's design and performance can also make it unsafe. Also, the weight of any accessories will reduce the maximum load the motorcycle can carry

LOADING

How much weight you put on your motorcycle, and how you load it, are important to your safety. This is a single rider bike and not recommended for taking extra passengers.



We recommend that you do not carry any cargo on this motorcycle.



ACCESSORIES & MODIFICATION

Modifying your motorcycle or using non-Thumpstar accessories can make your motorcycle unsafe.

ACCESSORIES

We strongly recommend that you use only Thumpstar Genuine Parts and Accessories that have been specifically designed or approved and tested for your motorcycle. Because Thumpstar cannot test all other accessories, you must be personally responsible for proper selection, installation, and use of non-Thumpstar accessories. Check with your dealer for assistance and always follow this guideline:

Make sure the accessory does not reduce ground clearance and lean angle, limit suspension travel or steering travel, alter your riding position, or interfere with operating any controls

MODIFICATIONS

We strongly advise you not to remove any original equipment or modify your motorcycle in any way that would change its design or operation. Such changes could seriously impair your motorcycle's handling, stability, and braking, making it unsafe to ride.

We also advise you not to make any modifications or remove any equipment that would make the motorcycle illegal in your area.



WARNING

Not wearing a helmet increases the chance of serious injury or death in a crash. Be sure you always wear a helmet, eye protection and other protective apparel when you ride.



WARNING

THIS BIKE IS A COMPETITION MODEL AND IS NOT MANUFACTURED FOR, NOR SHOULD IT BE USED ON PUBLIC STREETS, ROADS OR HIGHWAYS. THE USE OF THIS BIKE SHOULD BE LIMITED TO PARTICIPATION IN SANCTIONED COMPETITION EVENTS UPON A CLOSED COURSE. THIS BIKE SHOULD NOT BE USED FOR GENERAL OFF-ROAD RECREATIONAL RIDING. THIS BIKE IS INTENDED FOR EXPERIENCE RACERS ONLY
NOT FOR BEGINNERS

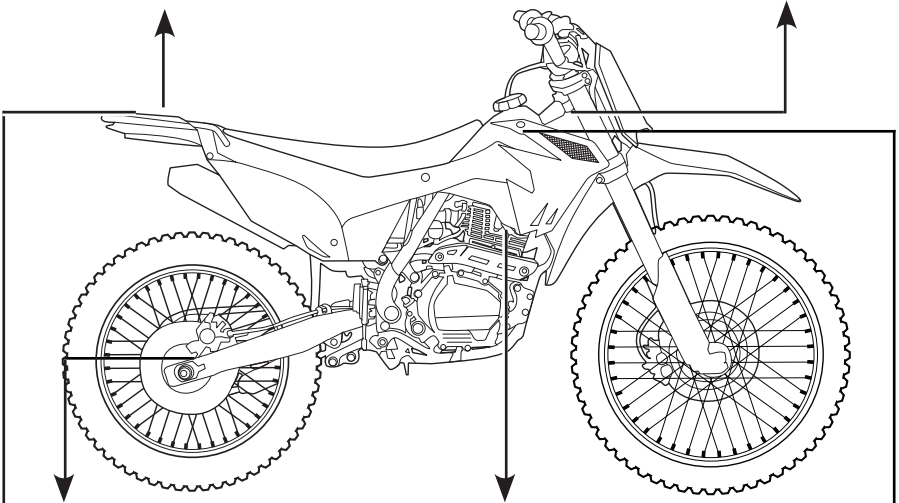

WARNING

Chain and Sprocket are dangerous. Keep body parts clear when riding.



CAUTION

Choke is off when switched to the down position. Choke is on when switched to the up position. Use choke when the bike is cold or difficult to start. Run no longer than 5 minutes with the choke on.



WARNING

No passengers on the bike. Ride at Your Own Risk as motorcycles are dangerous and should only be used by experienced riders.



WARNING

Gasoline is highly flammable. Use fresh clean gas 92 or higher, always turn the engine off during fueling to avoid fire or explosion. Always check for fuel leaks before riding.

When you ride off-road, you need to operate the throttle, brakes, and other controls without stopping to look at them. Read this section carefully before you ride. It describes the location, function, and operation of all the basic controls on your motorcycle.

OPERATION COMPONENT LOCATIONS

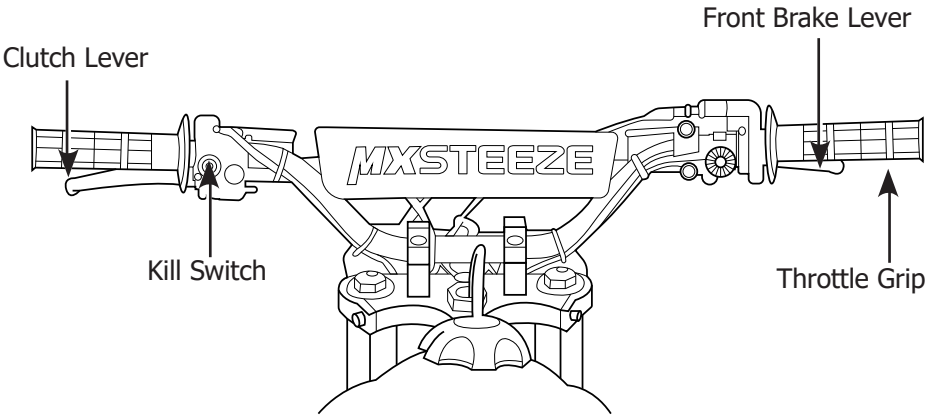

ENGINE STOP SWITCH

The engine stop switch is used to turn the engine off during normal riding situations. To operate, turn the switch to the OFF position. The switch must be in the RUN position to start the engine.

FRONT BRAKE LEVER

The front brake lever is used to slow or stop your motorcycle. To operate, pull the lever.

THROTTLE

The throttle controls engine rpm (speed). To increase engine rpm, rotate the grip toward you. To reduce engine rpm, rotate the grip away from you. The throttle will automatically return to the closed position (engine idle) when you remove your hand.

CLUTCH LEVER

The clutch lever is operated by a hand lever on the left handlebar. Without pressing the lever means that the clutch plates are engaged, while pulling the lever back towards the rider disengages the clutch plates through cable or hydraulic actuation, allowing the rider to shift gears.

FUEL VALVE

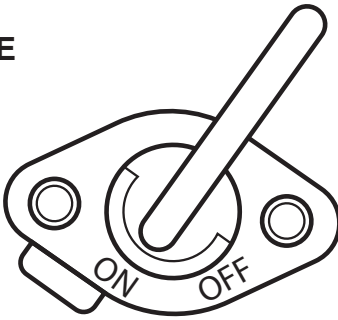

The two way fuel valve is used to control the flow of fuel from the fuel tank to the carburetor.

ON

Turning the fuel valve ON before attempting to start the engine allows fuel to flow from the fuel tank to the carburetor.

OFF

Turning the fuel valve OFF after stopping the engine prevents the flow of fuel from the fuel tank to the carburetor.

CHOKE KNOB

The choke knob is used for starting the engine. The choke increases the percentage of fuel in the fuel/air mixture delivered to the engine

ON

Used to start a cold engine with air temperature below 35°C (95°F).

OFF

Used for normal operation, for restarting a warm engine, or starting a cold engine with air temperature above 35°C (95°F).



More information on
Carburetor (page 50)



Before each ride, you need to make sure you and your Thumpstar are both ready to ride. To help get you prepared, this section discusses how to evaluate your riding readiness, and how to perform the recommended pre-ride inspection of your Thumpstar.

PREPARE TO RIDE

Before you ride your motorcycle for the first time, we strongly recommend that you:

- read this owner's Manual properly
- make sure you understand all the safety messages
- learn how to operate all the necessary controls

Before each ride, we also suggest that you make sure you:

- are in good mental & physical condition
- are free of alcohol and drugs
- are wearing an approved motorcycle helmet (with chin strap tightened securely), eye protection, and other protective gears.

PROTECTIVE GEAR

For your safety, we strongly recommend that you always wear an approved motorcycle helmet, eye protection, boots, gloves, long pants, and a long-sleeved jersey, shirt, or jacket whenever you ride. Although complete protection is not possible, wearing the proper gear can reduce the chance of injury when you ride.

Following are suggestions to help you choose the proper gear.

HELMETS AND EYE PROTECTION

Your helmet is your most important piece of riding gear because it offers the best protection against head injuries. A helmet should fit your head comfortably and have a chin strap that can be tightened securely.

An open-face helmet offers some protection, but a full-face helmet offers more. Regardless of the style, look for a ASNZ 1698 or D.O.T (Department of Transportation) sticker on any helmet you buy. Always wear a face shield or goggles to protect your eyes and help your vision.

ADDITIONAL PROTECTIVE GEAR

In Addition to a helmet and eye protection, we also recommend the following:

- Sturdy off-road motorcycle boots to help protect your feet, ankles and lower legs.
- Off-road motorcycle gloves to help protect your hands.
- Riding pants with knee and hip pads, a riding jersey with padded elbows, chest and shoulder protectors. more info at *page 10 & 11*



WARNING

Not wearing a helmet increases the chance of serious injury or death in a crash. Be sure you always wear a helmet, eye protection and other protective apparel when you ride.

Before each ride, it's important to inspect your motorcycle and make sure any problem you find is corrected. A **pre-ride inspection** is a must because off-road riding can be tough on a motorcycle and you don't want to have a breakdown far from help.



WARNING

Improperly maintaining this motorcycle or failing to correct a problem before riding can cause a crash in which you can be seriously hurt or killed.

Always perform a pre-ride inspection before every ride and correct any problems.

Check the following items before you get on the motorcycle:

Tires	Use a gauge to check the air pressure. Adjust if needed. Also look for signs of damage or excessive wear (<i>page 77</i>)
Spokes & Rims	Make sure the spokes are tight. Also check the rims for damage (<i>page 72</i>)
Leaks	Look under the motorcycle for signs of leaking fluids (fuel, engine oil). (<i>page 43 & 69</i>)
Engine Oil	Check the level and add oil if needed (<i>page 45</i>)
Fuel	Check the level and add fuel if needed. Also make sure the fuel fill cap is securely fastened. (<i>page 43</i>)
Drive Chain	Check the condition and slack. Adjust and lubricate if needed. Also check the chain slider for wear and replace if needed (<i>page 81</i>)
Cables	Check the cable housings for wear. Check the fittings for looseness. Replace or tighten as needed. (<i>page 56 & 59</i>)
Nuts & Bolts	Use a wrench to make sure all accessible nuts, bolts, and fasteners are tight. (<i>page 118</i>)
Spark Plug & Cap	Check for looseness (<i>page 64</i>)

Throttle	Check the freeplay and adjust if needed. Rotate the throttle to make sure it moves smoothly without sticking, and snaps shut automatically when it is released, in all steering positions (<i>page 56</i>)
Brakes	Squeeze the front brake lever and step on the rear brake pedal to check that the controls operate normally. Adjust freeplay, if necessary. (<i>page 69</i>)

Remember, be sure to take care of any problem you find or have your **Certified Motorcycle Mechanic** correct it before you ride.

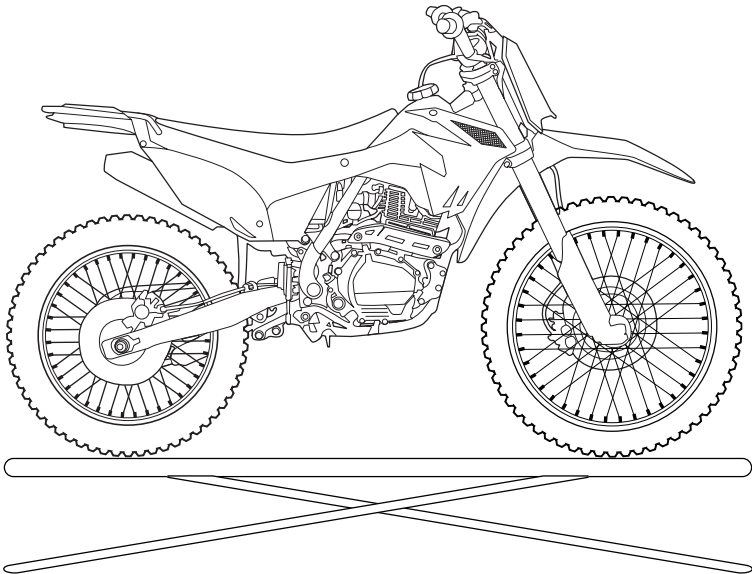

This section gives basic information on how to begin riding your motorcycle. It includes how to start and stop your engine, how to use the throttle and brakes, and what to do when you're through riding.

SAFETY RIDING PRECAUTIONS

Before riding your motorcycle for the first time, please review the *Motorcycle Safety*.

This model is designed for experienced riders, take time to become familiar with how this motorcycle works and handles. Practice in a safe area until you build up your skills and get accustomed to your motorcycle's size and weight.

For your safety, avoid starting or operating the engine in an enclosed area such as a garage. Your motorcycle's exhaust contains poisonous carbon monoxide gas which can collect rapidly in an enclosed area and cause illness or death.

Your motorcycle is not equipped with lights.

Do not ride at night.

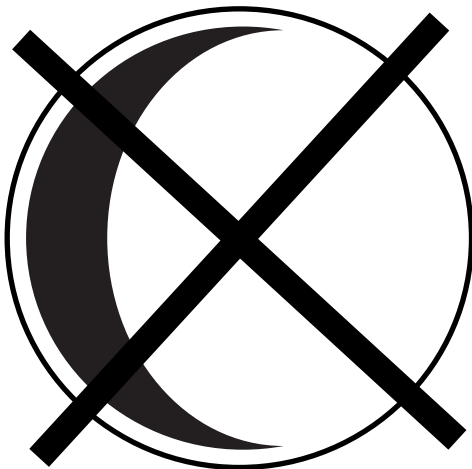

Always follow the proper starting procedure described below.

PREPARATIONS

Before Starting, turn the fuel valve ON and make sure bike is in NEUTRAL.

STARTING PROCEDURE

To restart a warm engine, follow the procedure for High Air Temperature on *page 27*.

Normal Air Temperature

10° 35°C (50° 95°F)

1. Push the choke knob up all the way to fully ON.
2. Press the start button and begin to warm up the engine by opening and closing the throttle. (Caution: DO NOT turn the throttle too much otherwise the motorcycle will move forward because of the automatic gearing)

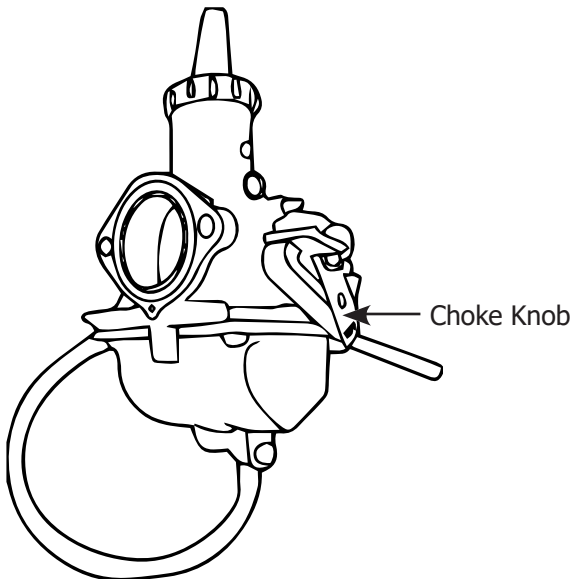

3. About a quarter-minute after the engine starts, push the choke knob in all the way down to fully OFF.
4. If idling is unstable, open the throttle slightly.

High Air Temperature or to restart warm engine 35°C (95°F) or above

1. Do not use the choke.
2. Start the engine (See step 2 under Normal Air Temperature)

Low Air Temperature 10°C (50°F) or below

1. Follow steps 1- 2 under Normal Air Temperature.
2. Warm up the engine by opening and closing the throttle slightly.
3. Continue warming up the engine until it runs smoothly and responds to the throttle when the choke knob is at fully OFF.

Note: Will take at least 5 to 10 minutes for your engine to be warmed up and start smoothly

NOTICE:

Extended use of the choke may impair piston and cylinder wall lubrication and damage the engine.

HOW TO STOP THE ENGINE

To stop the engine, shift into neutral, then press the kill switch button.

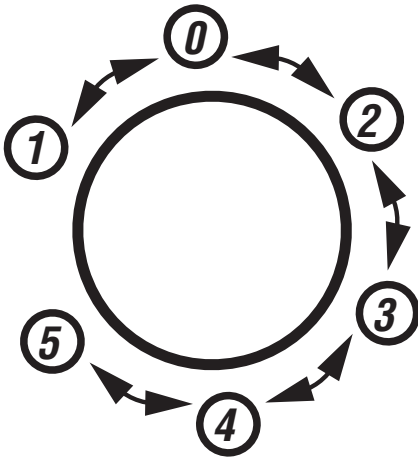

Your motorcycle has four forward gears.

To start riding, after engine has been warmed up and the side stand raised:

1. Close the throttle and pull the clutch lever in.
2. Raise the shift lever from neutral up to first gear.
3. Release the clutch lever. Gradually open the throttle.
4. When you attain a moderate speed, close the throttle, pull the clutch lever in and raise the shift lever. After shifting, release clutch and apply the throttle.
5. To continue shifting up to each higher gear, repeat step 4.
6. To shift down to a lower gear, close the throttle, pull the clutch lever in and depress the shift lever. After shifting, apply the throttle.

Remember to close the throttle before shifting.

NOTICE:

Improper shifting may damage the engine, transmission, and drive train.

Upshift to a higher gear or reduce throttle before engine rpm (speed) gets too high.

Downshift to a lower gear before you feel the engine laboring (lugging) at low rpm.

NOTICE:

Downshifting can help slow your motorcycle, especially on downhills. However, downshifting when engine rpm is too high can cause engine damage.

NOTICE:

To prevent transmission damage, do not coast or tow the motorcycle for long distances with the engine off .

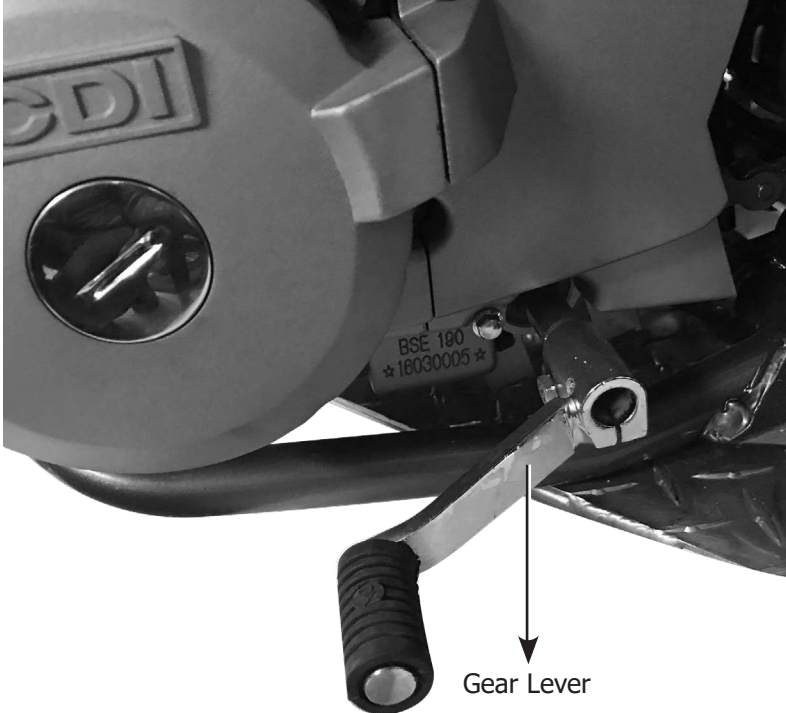

To slow or stop, apply the front brake and rear brake pedal smoothly, while downshifting to match your speed. Gradually increase braking as you feel the brakes slowing your speed. For support, put your left foot down first, then your right foot when you have finished using the rear brake.

For maximum braking, close the throttle and firmly apply the brake lever and pedal controls.

Applying the brakes too hard may cause the wheels to lock and slide, reducing control of your motorcycle. If this happens, release the brake controls, steer straight ahead until you regain control, then reapply the brakes more gently.

Generally, reduce your speed or complete braking before beginning a turn. Avoid braking or closing the throttle quickly while turning. Either action may cause one or both wheels to slip. Any wheel slip will reduce your control of your motorcycle.

When riding in wet or rainy conditions, or on loose surfaces, the ability to maneuver and stop will be reduced. All of your actions should be smooth under these conditions. Rapid acceleration, braking or turning may cause loss of control. For your safety, exercise extreme caution when braking, accelerating, or turning.

When descending a long, steep grade, use engine compression braking by downshifting, with intermittent use of both brakes.

Lower the side stand to support your motorcycle. Push the kill switch button. If you're finished riding for the day, also turn the fuel valve OFF. Always choose a level place to park.

POST-RIDE INSPECTION

When you return home after riding, thoroughly clean your motorcycle and remove any dirt, mud, brush, rocks or other objects you may have picked up along the way. After cleaning, carefully inspect your motorcycle for leaks or damage.

Servicing Your Thumpstar

Keeping your motorcycle well maintained is absolutely essential to your safety. It's also a good way to protect your investment, get maximum performance, avoid breakdowns, and have more fun.

To help keep your motorcycle in good shape, this section includes a Maintenance Schedule for required servicing and step-by-step instructions for specific maintenance tasks. You'll also find important safety precautions, information on oils, and tips for keeping your Thumpstar looking good.



The Importance of your Maintenance

A well-maintained motorcycle is essential for safe, economical, and trouble-free riding. It will also help reduce air pollution. Careful pre-ride inspections and good maintenance are especially important because your motorcycle is designed to be ridden over rough off-road terrain.

To help you properly care for your motorcycle, this section of the manual provides a Maintenance Schedule. The service intervals in this schedule are based on average riding conditions.

More frequent service is needed if you subject your motorcycle to severe use such as competition or ride in unusually wet or dusty areas.

Frequent servicing of the air cleaner is especially important to help you avoid a possible costly engine repair.

If your motorcycle overturns or is involved in a crash, be sure your **Certified Motorcycle Mechanic** inspects all major parts, even if you are able to make some repairs.



WARNING

Improperly maintaining this motorcycle or failing to correct a problem before you ride can cause a crash in which you can be seriously hurt or killed. Always follow the inspection and maintenance recommendations and schedules in this owner's manual.

Remember, proper maintenance is the owner's responsibility. Be sure to inspect your motorcycle before each ride and follow the Maintenance Schedule in this section

MAINTENANCE SAFETY

The maintenance section includes instructions on how to perform some important maintenance tasks. Some of the most important safety precautions follow. However, we cannot warn you of every conceivable hazard that can arise in performing maintenance. Only you can decide whether or not you should perform a given task.



WARNING

Failure to properly follow maintenance instructions and precautions can cause you to be seriously hurt or killed. Always follow the procedures and precautions in this owner's manual.

Important Safety Precautions

Make sure the engine is off before you begin any maintenance or repairs.

This will help eliminate several potential hazards:

- Carbon monoxide poisoning from engine exhaust. Be sure there is adequate ventilation whenever you operate the engine.
- Burns from hot motorcycle parts. Let the engine and exhaust system cool before touching.
- Injury from moving parts. Do not run the engine unless instructed to do so.
- Read the instructions before you begin, and engine unless instructed to do so. make sure you have the tools and skills required.
- To help prevent the motorcycle from falling over, park it on a firm, level surface, using the side stand or a maintenance stand to provide support.
- To reduce the possibility of a fire or explosion, be careful when working around gasoline. Use only a non-flammable (high flash point) solvent such as kerosene not gasoline to clean parts. Keep cigarettes, sparks, and flames away from all fuelrelated parts.

To maintain the safety and reliability of your motorcycle, regular inspection and service is required as shown in the Maintenance Schedule that follows.

The Maintenance Schedule lists items that can be performed with basic mechanical skills and hand tools. Procedures for these items are provided in this manual.

The Maintenance Schedule also includes items that involve more extensive procedures and may require special training, tools, and equipment. Therefore, we recommend that you have your **Certified Motorcycle Mechanic** perform these tasks unless you have advanced mechanical skills and the required tools. Procedures for items in this schedule are provided in a service manual available for purchase from your dealer.

Because your motorcycle does not have an odometer, service intervals in the maintenance schedules are expressed in terms of hours as well as miles/kilometers. To avoid overlooking required service, we urge you to develop a convenient way to record the number of days and/or miles you ride.

If you do not feel capable of performing a given task or need assistance, remember that your **Certified Motorcycle Mechanic** knows your motorcycle best and is fully equipped to maintain and repair it. If you decide to do your own maintenance, use only Thumpstar Genuine Parts or their equivalents for repair or replacement to ensure the best quality and reliability.

MAINTENANCE PROCEDURES

X: Inspect and clean, adjust, lubricate, or replace, if necessary

C: Clean

A: Adjust

L: Lubricate

R: Replace

Maintenance Schedule

<i>ITEMS</i>	<i>NOTE</i>	<i>Each race or about 2.5 hours</i>	<i>Every 3 races or about 10 hours</i>	<i>Every 6 races or about 20 hours</i>	<i>Every 9 races or about 30 hours</i>	<i>Every 12 races or about 40.0 hours</i>
Throttle Inspection		X				
Air Filter	1	C				
Crankcase Breather		X				
Spark Plug		X				
Valve Clearance	4			X		
Engine Oil	3	X				
Engine Idle Speed		X				
Drive Chain		X,L		R		
Drive Chain Slider		X				
Drive Chain Roller		X				
Drive Sprocket		X				
Driven Sprocket		X				
Brake Fluid	2	X				
Brake Pads Wear		X				
Brake System		X				
Clutch System		X				
Control Cables		X,L				
Exhaust Pipe / Muffler		X				
Suspension		X				
Swingarm / Shock Linkage			L			
Nuts, Bolts, Fasteners		X				
Wheels / Tires		X				
Steering Head Bearings					X	

This maintenance schedule is based upon average riding condition. Machines subjected to severe use require more frequent servicing.

NOTE:

- 1.Clean after every heat for dusty riding conditions.
- 2.Replace every 2 years. Replacement requires mechanical skill.
- 3.Replace after the first break-in ride.
- 4.Inspect after the first break-in ride.

Perform the pre-ride inspection at each scheduled maintenance period.

Each item on the maintenance schedule requires some mechanical knowledge. Certain items may require more technical information and tools. Consult your **Certified Motorcycle Mechanic**.

SUMMARY OF MAINTENANCE SCHEDULE NOTES AND PROCEDURES (*page 129*)

Note: Service more frequently when ridden in wet or dusty conditions.

Thumpstar Motorbikes promote safety as paramount. As such, it is advised that before each and every use of your bike that you actively walk around your motorcycle and check that everything appears in order. Maintenance should be undertaken regularly and servicing should be carried out by the appropriate persons. Thumpstar recommend any work being carried out on any of our range of dirt bikes should be done by an approved mechanic.

The following list has been provided for you by Thumpstar Motorbikes as an advisory process before each ride.

FRONT AND REAR BRAKE

When checking the brakes, ensure all cables are in place and there are no leaks. Check the braking mechanism works manually before riding. Some brakes are adjustable for performance reasons; brake adjustments are sensitive and in the interest of safety should only be carried out by a skilled mechanic. *(page 70)*

FUEL LINE AND TANK

It is important to check for any fuel leaks around the tanks and along fuel lines. Bike engines become hot during use and therefore pose a fire risk. *(page 44)*

OIL LEVELS

Oil Levels Should be checked prior to each usage, the “dipstick” can be found on the right cover of the crank case, much like a car this is used to check the oil levels, if the engine is low on oil top up to a suitable level. The dipstick should always be replaced firmly and securely. The oil supplied with the motorcycle is transport oil that should be changed after the first 4 hours of usage. *(page 46)*

REPLACING THE OIL

- Remove the “sump plug”
- Drain the oil from the engine
- Replace the sump plug
- Refill the engine with a high quality oil suitable for the engine

PLEASE NOTE: Never maintain the engine when it is hot as this can cause injury, leaks of petrochemicals can cause fires, explosions and even death.

Whether your Bike has a 2 – Stroke or 4 – Stroke engine, your bike engine relies on a good supply of high quality engine oil. Failure to the oil supply can permanently damage your engine, and oil leaks can cause the loss of control to your Bike.

SPARK PLUG

- . Remove the coil/lead from the spark plug
- . Remove the spark plug with the correct tool
- Ensure the Gap at the contactors is 0.6-0.7mm
- Clean around the contactors (where the spark is emitted from) or replace the unit (*page 65*)

AIR FILTER

Check the air filter after each usage of the motorcycle. Where applicable remove the air filter for cleaning

Wash the filter or soak it with an air filter cleaner or machine oil, if the filter is in any way damaged, please source a replacement filter appropriate for fitting to the Carburetor.

CAUTION: Make sure the air filter is correctly fitted to the bike; failure to fit the filter will result in contaminants entering the engine and cause fatal damage to the engine components (*page 55*)

THROTTLE

The throttle of your motorcycle directly affects the speed of your bike, it should be in perfect working order before each time you ride your bike. Check and ensure that the cable and all mechanical parts included in the throttle system are moving freely. (*page 57*)

The Carburetor is also considered part of the throttle system and may also require adjustment. It is not advised to make adjustments whilst the engine is running. Repeat adjustments whilst the engine id off and test each adjustment afterwards.

To adjust the Carburetor:

- Support the motorcycle by means of the side stand
- Adjust the idling speed using the adjustment screw (recommended r/min are aprox. 1500 r/min)

PLEASE NOTE: Do not make adjustments to a cold engine as this is the most changeable state of the engines running. Adjustments should not be made by unqualified persons, if in doubt please consult a qualified mechanic. (*page 50*)

CHAIN

It is advisable to visually check the chain of your bike before each use. Its general condition is important, there should be no obstructions to the chain, it should be well lubricated and under the correct tension. (*page 82*)

TIRES

Thumpstar Motorbikes advise that you should check the condition and wear of your tires before every ride. Tire pressure should be checked intermittently (please refer to “Tips for Servicing and Maintenance” for further information). Tires can be damaged by rough terrain

In the event of any discrepancies or faults discovered during your safety checks, please refer to “Tips for Servicing and Maintenance” or contact an approved mechanic. (*page 78*)

GENERAL CLEANLINESS

The cleaning of your motorcycle can prolong the life of many component parts such as, plastics, brakes and frame etc. Jet washing can cause damage to certain components i.e. Air filters.

PLEASE NOTE:

Some cleaning chemicals can remove oils and lubricants that are vital to the running condition of the Bike. It is highly recommended that all lubricated areas are treated with the correct lubricants. Do not use corrosive detergents for the cleaning of the motorcycle. Brakes can be rendered ineffective if wet or contaminated with detergents, please allow for drying time prior to reusing the motorcycle after cleaning.

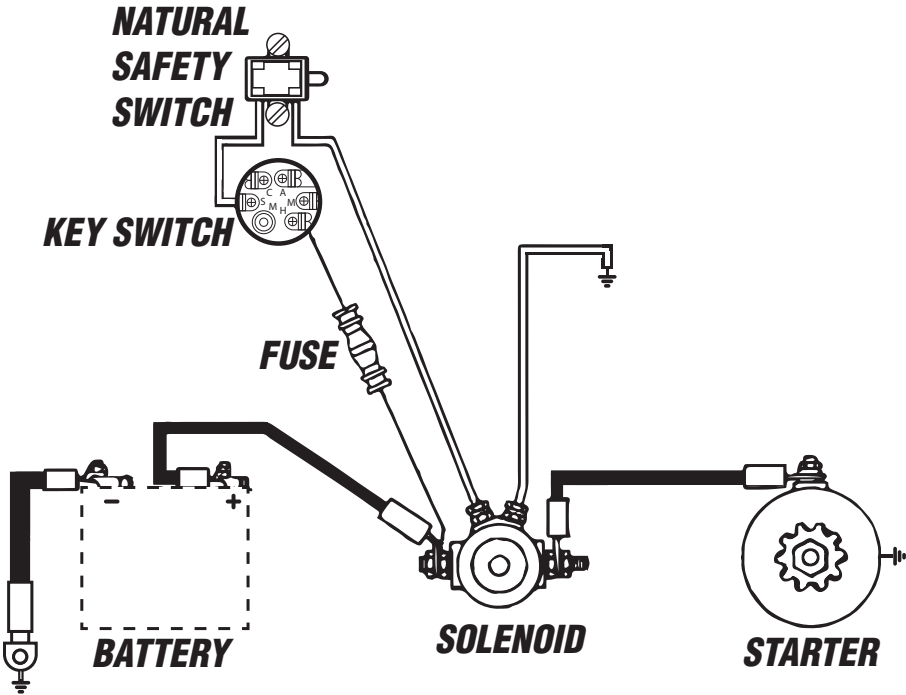

FUEL RECOMMENDATION

Type	Unleaded
Pump Octane Number	86 (or higher)

Your engine is designed to use any unleaded gasoline that has a pump octane number of 86 or higher. Gasoline pumps at service stations normally display the pump octane number.

Use of lower octane gasoline can cause persistent “pinging” or “spark knock” (a louder rapping noise) which, if severe, can lead to engine damage. (Light pinging experienced while operating under a heavy load, such as climbing a hill, is no cause for concern.)

If pinging or spark knock occurs at a steady engine speed under normal load, change brands of gasoline. If pinging or spark knock persists, consult your **Certified Motorcycle Mechanic**.

Use only unleaded fuel in your Thumpstar. If you ride your Thumpstar in a country where leaded fuel might be available, take precautions to use only unleaded fuel.

Never use stale or contaminated gasoline or an oil/gasoline mixture. Avoid getting dirt, dust, or water in the fuel tank.

Getting dirt or dust on your fuel can block you Carburetor which can cause it to leak and cause other problems as well.



WARNING

Gasoline is highly flammable and explosive. You can be burned or seriously injured when handling fuel. Stop the engine and keep heat, sparks and flame away. Handle fuel only outdoors. Wipe up spills immediately.

REFUELING PROCEDURE

Fuel Tank Capacity, including reserve: 1.06 US gal (4.0)

Reserve Capacity: 0.26 US gal (1.0)



1. To open the fuel fill cap, pull the breather tube out of the steering stem nut. Turn the fuel fill cap counterclockwise and remove it.
2. Add fuel until the level reaches the bottom of the filler neck. Avoid overfilling the tank. There should be no fuel in the filler neck.
3. After refueling, turn the fuel fill cap clockwise until it is secure.
4. Insert the breather tube in the steering stem nut.

If you replace the fuel fill cap, use only a Thumpstar Genuine replacement part.

Using the proper oil, and regularly checking, adding, and changing oil will help extend your engine's life. Even the best oil wears out. Changing oil helps get rid of dirt and deposits held in the engine. Operating the engine with old or dirty oil can damage your engine. Running the engine with insufficient oil can cause serious damage to the engine and transmission.

OIL RECOMMENDATION

API classification	SG or higher except oils labeled as energy conserving on the circular API service label
viscosity (weight)	SAE 10W-30* / 10W-40*
JASO T 903 standard	MA
suggested oil**	4-stroke oil, or an equivalent motorcycle oil

*For normal air temperatures. See next page for additional temperature/viscosity information.

**Suggested oils are equal in performance to SJ oils that are not labeled as energy conserving on the circular API service label.

Your motorcycle does not need oil additives. Use the recommended oil.

- Do not use oils with graphite or molybdenum additives. They may adversely affect clutch operation.
- Do not use API SH or higher oils displaying a circular API “energy conserving” service label on the container. They may affect lubrication and clutch performance.
- Do not use non-detergent, vegetable, or castor based racing oils.

Other viscosities shown in the following chart may be used when the average temperature in your riding area is within the indicated range.

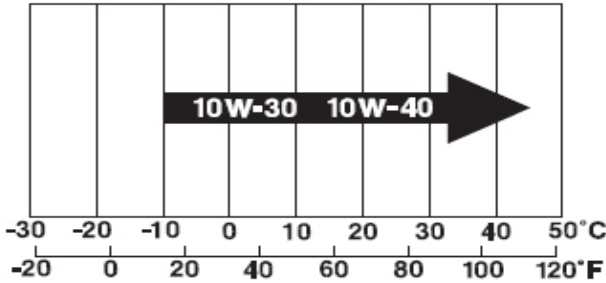

JASO T 903 standard

The JASO T 903 standard is an index for engine oils for 4-stroke motorcycle engines. There are two classes: MA and MB. Oil conforming to the standard is labeled on the oil container. For example, the following label shows the MA classification.

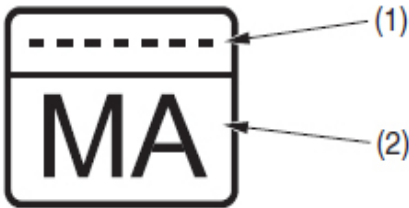

(1) oil code

(2) oil classification

CHECKING & ADDING OIL

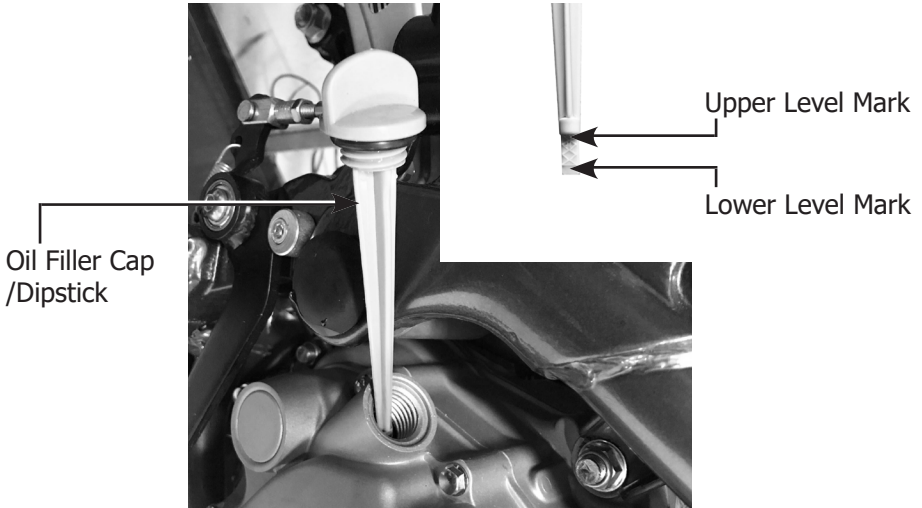

1. Park your motorcycle on a firm, level surface.
2. Clean around the oil fill cap/dipstick and nearby surfaces.
3. Start the engine and let it idle for 3-5 minutes. Stop the engine. Wait 2-3 minutes.
4. Unscrew and remove the oil fill cap/dipstick. Wipe it clean.
5. Hold the motorcycle upright.
6. Insert the oil fill cap/dipstick until it seats, but do not screw it in.
7. Remove the oil fill cap/dipstick and check the oil level.
 - If the oil is at or near the upper level mark, you do not have to add oil.
 - If the oil is below or near the lower level mark, add the recommended oil until it reaches the upper level mark. (Do not overfill.)
8. Insert the oil fill cap/dipstick and screw it in tightly.
9. Check for oil leaks.

CHANGING ENGINE OIL



1. If the engine is cold, start it and let it idle for 3-5 minutes. Turn the engine off. Wait 2-3 minutes for the oil to settle.
2. Park your motorcycle on a firm, level surface.
3. Remove the oil fill cap/dipstick.
4. Place a drain pan under the crankcase.
5. Unscrew and remove the oil drain bolt and washer.
6. After most of the oil is drained, gently tilt the motorcycle from side to side to drain the remaining oil.
7. Pour the drained oil into a suitable container and dispose of it in an approved manner.
8. Remove the old sealing washer and install a new sealing washer on the drain bolt.
9. Install the oil drain bolt and tighten to the specified torque:
18 lbf·ft (24 N·m, 2.4 kgf·m)
10. Pour the recommended oil into the crankcase, approximately:
1 Liter
11. Install the oil fill cap/dipstick securely.
12. Start the engine. Let it idle 3-5 minutes, then turn it off.
13. With the motorcycle held upright on level ground, check the oil level.
If needed, add oil until it reaches the upper level mark. (Do not overfill.)
14. Check for oil leaks.

HIGH ALTITUDE CARBURETOR ADJUSTMENT

At high altitude, the standard carburetor air/fuel mixture will be too rich. Performance will decrease, and fuel consumption will increase. A very rich mixture will also foul the spark plug and cause hard starting. Operation at an altitude that differs from that at which this engine was certified, for extended periods of time, may increase emissions.

High altitude performance can be improved by specific modifications to the carburetor. If you always operate your engine at altitudes above 6,500 feet (2,000 meters), have your servicing dealer perform this carburetor modification. This engine, when operated at high altitude with the carburetor modifications for high altitude use, will meet each emission standard throughout its useful life.

Even with carburetor modification, engine horsepower will decrease about 3.5% for each 1,000-foot (300-meter) increase in altitude. The effect of altitude on horsepower will be greater than this if no carburetor modification is made.

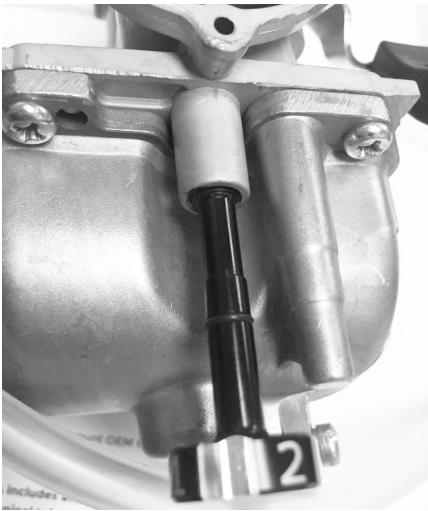

Adjustable Air Fuel/Pilot Screw



Use to adjust air fuel mixture for your bike

*Sold Separately

CARBURETOR CIRCUIT FUNCTIONS

The carburetor has several circuits, each providing the fuel/air mixture over a given portion of throttle valve opening.

These circuits overlap as show below.

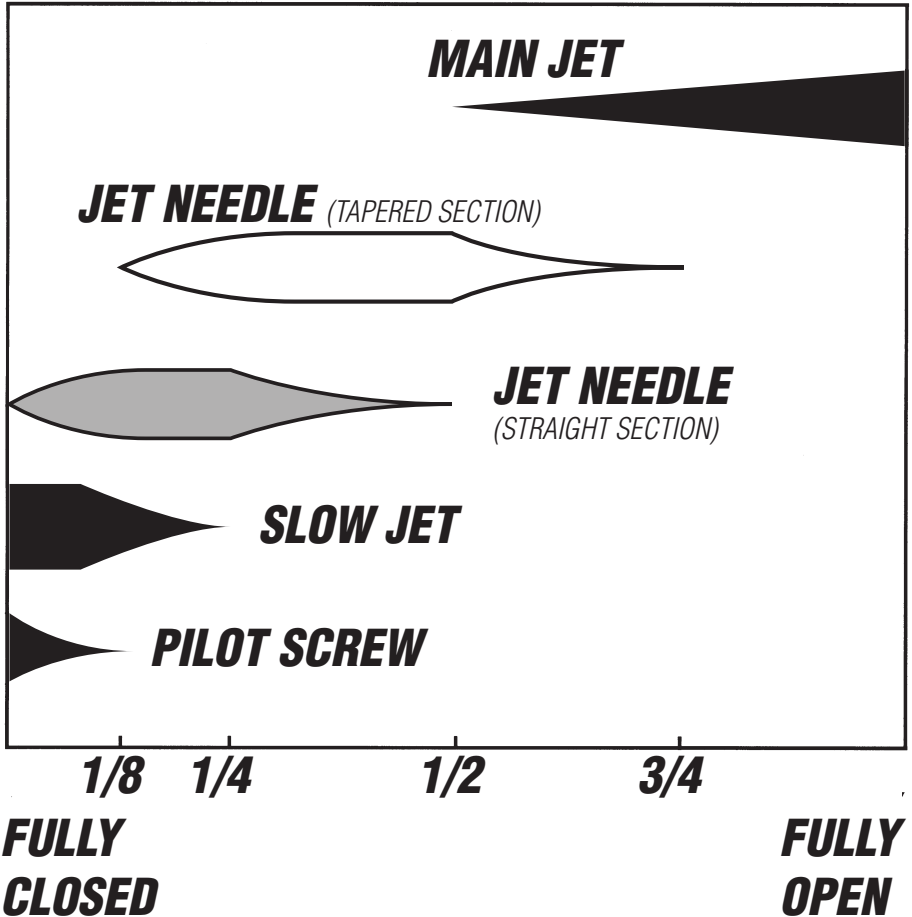

MAIN JET

The main jet affects fuel/air ratio from half ($1/2$) to full throttle ($4/4$). The size should be reduced at higher altitudes.

JET NEEDLE

The jet needle controls fuel/air mixture over fully closed to 3/4 throttle. The straight section affects throttle response at smaller throttle openings. By changing the position of the clip in its groove, you can improve acceleration at medium low and medium speed.

SLOW JET AND AIR FUEL / PILOT SCREW

The slow jet and pilot screw affects fuel/air ratio over fully closed to 1/4 throttle. Adjust the pilot screw to obtain the best off-idle performance.

- If the engine blubbers (rich) exiting a corner, turn the pilot screw clockwise to lean the mixture.
- If the engine surges (lean) exiting a corner, turn the pilot screw counterclockwise to richen the mixture.

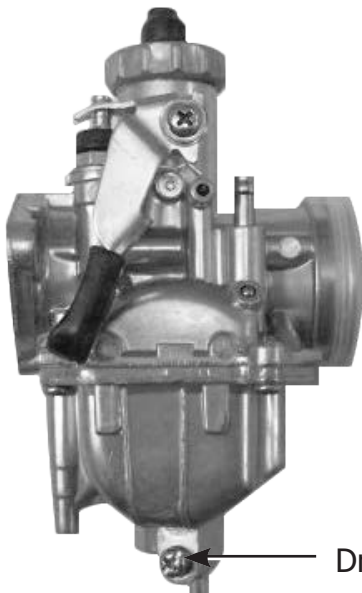
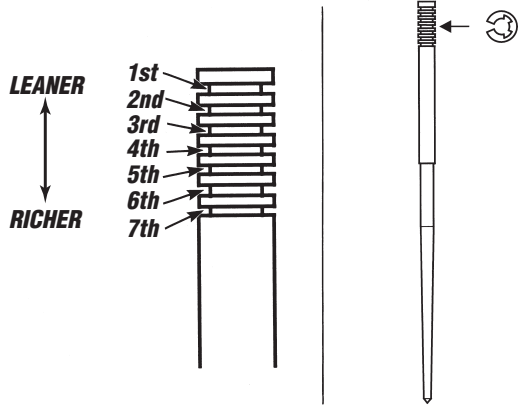

The minimum to maximum range of pilot screw adjustment is 1 to 1 3/4 turns out from the lightly seated position. If you exceed 1 3/4 turns out, the next larger slow jet is needed. If you are under 1 turns out, the next smaller slow jet is needed.

STANDARD TUNING RECOMMENDATIONS

For the following recommendations to be accurate, you must use the standard settings as a baseline. Also, don't change any of the settings until you've determined what changes are necessary.

Adjustment	TSF 189 TSF 230 - PE28 Standard Settings
Pilot / Air Fuel Screw Opening	
Slow/Pilot Jet	
Needle Clip Position	
Main jet	

ADJUSTMENTS FOR ALTITUDE & TEMPERATURE

All jetting recommendations are based on standard jetting with an unmodified engine. The following conditions can affect the fuel mixture

Condition	Mixture Will Be	Adjust To	Component Affected
Cold Temperature	Lean	Richen	Main Jet (Jet Needle Stage)
Warm Temperature	Rich	Lean	
Dry Air	Lean	Richen	
High Humidity	Rich	Lean	
High Altitude	Rich	Lean	

SPECIAL TUNING CONDITIONS

There are some unique atmospheric conditions or situations that may require additional adjustments. It should not be necessary to go more than one jet size richer or leaner to fine tune your Thumpstar. If larger jetting changes are necessary, check for air leaks, blocked or restricted exhaust or fuel systems, or a dirty air cleaner.

Condition	Main Jet Adjustment
Long Straights	Next Larger
Uphill Sections	
Sand	
Mud	
High Humidity	Next Smaller
Raining	
Hotter Than 113 °F (59 °C)	

Proper air cleaner maintenance is very important for off-road motorcycles. A dirty, water-soaked, worn-out, or defective air cleaner will allow dirt, dust, mud, and other impurities to pass into the engine.

Service the air cleaner more frequently if you ride in unusually wet or dusty areas. Your **Certified Motorcycle Mechanic** can help you determine the correct service interval for your riding conditions.

Your motorcycle's air cleaner has very specific performance requirements. Use a new Thumpstar Genuine air cleaner specified for your model or an air cleaner of equal quality.

NOTICE:

Using the wrong air cleaner may result in premature engine wear.

Proper air cleaner maintenance can prevent premature engine wear or damage, expensive repairs, low engine power, poor gas mileage, and spark plug fouling.

Improper or lack of proper air cleaner maintenance can cause poor performance and premature engine wear.

CLEANING

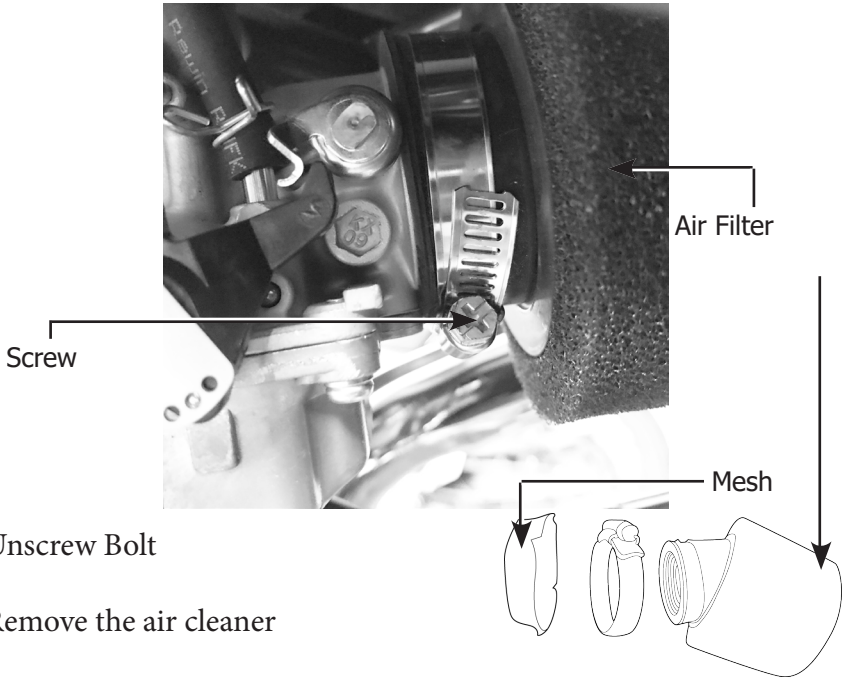

1. Unscrew Bolt
2. Remove the air cleaner
3. Gently wash the air cleaner in clean, nonflammable (high flash point) solvent such as kerosene not gasoline. After cleaning, gently squeeze out the remaining solvent. Avoid twisting or wringing the air cleaner. This can tear the foam.
4. Inspect for tears or cracks in the foam or seams of the air cleaner. Replace the air cleaner if it is damaged.
5. Allow the air cleaner to dry thoroughly before applying oil. A wet air cleaner will not fully absorb the oil.
6. Check anti-flame mesh for damages
7. Pour clean No Toil Biodegradable or an equivalent over the entire surface of the air cleaner. Use both hands to evenly spread the oil into the air cleaner. Gently squeeze out any excess oil.
8. Install the air cleaner and screws back again.

UPPER ADJUSTMENT

Minor adjustments are generally made with the upper adjuster.

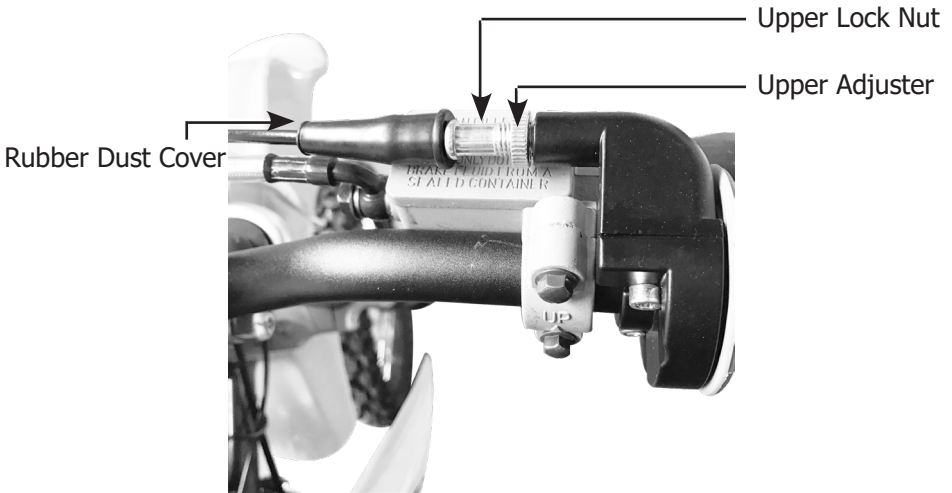

1. Pull the rubber dust cover back.
2. Loosen the upper lock nut on the throttle cable mechanism.
3. Turn the upper adjuster.
4. Tighten the lock nut. Return the dust cover to its normal position.
5. After adjustment, check for smooth rotation of the throttle grip from fully closed to fully open in all steering positions.

SECOND ADJUSTMENT

The second adjuster is used for major freeplay adjustment, such as after replacing the throttle cables or removing the carburetor. It is also used if you can not get the proper adjustment with the upper adjuster



1. Loosen the locking nut.
2. Turn the second adjuster.
3. Tighten the locking nut.

Maintenance tip: Recommend using a service spray WD40 or equivalent inside the throttle cable housing and throttle



THROTTLE INSPECTION

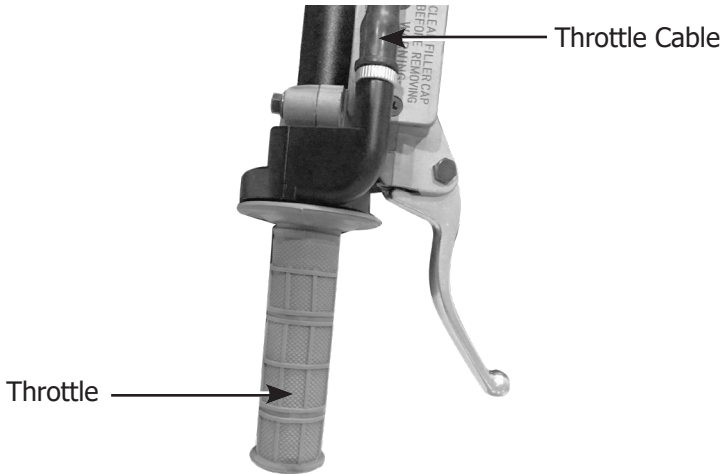

1. Check that the throttle assembly is positioned properly and the securing bolts are tight.
2. Check for smooth rotation of the throttle from fully open to fully closed in all steering positions. If there is a problem, see your **Certified Motorcycle Mechanic**
3. Inspect the condition of the throttle cables from the throttle grip down to the carburetor. If the cable is kinked or chafed, have it replaced.
4. Check the cables for tension or stress in all steering positions
5. Lubricate the cables with a commercially available cable lubricant to prevent premature rust and corrosion. (ie: WD40 or similar product)

CLUTCH FREEPLAY

Clutch Lever



INSPECTION

Check Freeplay

If necessary, adjust to the specified range. Improper freeplay adjustment can cause premature clutch wear.

UPPER ADJUSTMENT

Minor adjustments are generally made with the upper clutch cable adjuster.

Upper Lock Nut

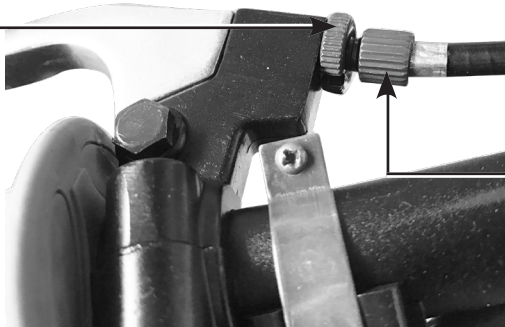

Upper Clutch
Cable Adjuster

1. Loosen the upper lock nut.
2. Turn the upper clutch cable adjuster to obtain the specified freeplay.
3. Tighten the lock nut and check the freeplay again.
4. Return the dust cover to its normal position.

LOWER ADJUSTMENT

The lower clutch cable adjuster is used if the upper clutch cable adjuster is threaded out near its limit or the correct freeplay cannot be obtained.

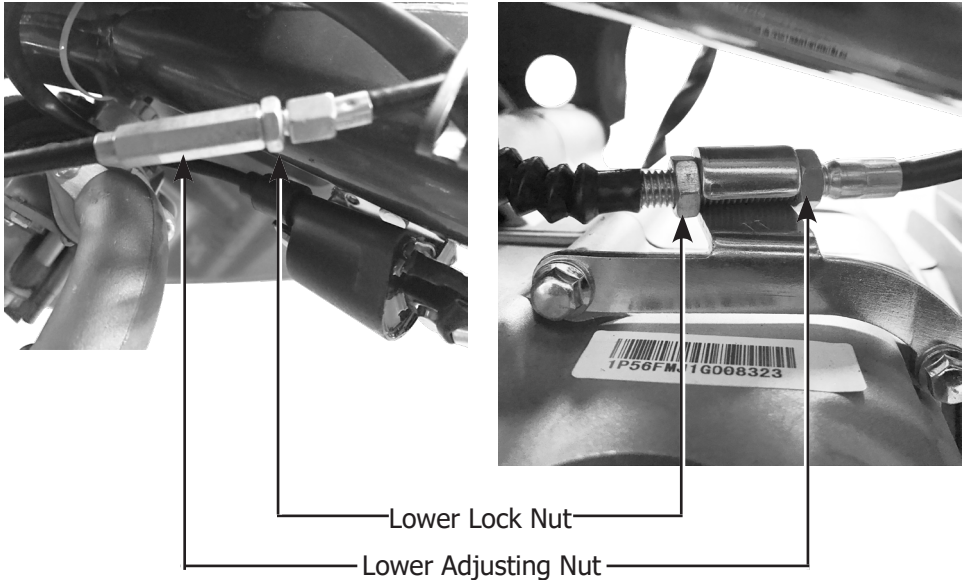

1. Loosen the upper lock nut and turn the upper clutch cable adjuster all the way in.
2. Tighten the upper lock nut and pull the dust cover back to its normal position.
3. Hold the lower adjusting nut and loosen the lower lock nut at the lower end of the cable.
4. Turn the lower adjusting nut to obtain the specified freeplay
5. Hold the lower adjusting nut and tighten the lower lock nut. Check the adjustment.
6. Start the engine, pull the clutch lever in, and shift into gear. Make sure the engine does not stall and the motorcycle does not creep. Gradually release the clutch lever and open the throttle. Your motorcycle should move smoothly and accelerate gradually.

Excessive valve clearance will cause noise and eventual engine damage. Little or no clearance will prevent the valve from closing and cause valve damage and power loss. Check valve clearance when the engine is cold at the intervals specified in the Maintenance Schedule.

The checking or adjusting of the clearance should be performed while the engine is cold. The clearance will change as engine temperature rises.

1. Remove the cylinder head cover by removing the bolts and mount rubbers.
2. Remove the cylinder head cover gasket.
3. Remove the crankshaft hole cap and timing hole cap
4. Rotate the generator flywheel counterclockwise until the T mark on the flywheel lines up with the index mark on the left crankcase cover. In this position, the piston may either be on the compression or exhaust stroke.

The adjustment must be made when the piston is at the top of the compression stroke when both the intake and exhaust valves are closed. This condition can be determined by moving the rocker arms. If they are free, it is an indication that the valves are closed and that the piston is on the compression stroke. If they are tight and the valves are open, rotate the flywheel 360° and realign the T mark to the index mark.

5. Check the clearance of both valves by inserting a feeler gauge between the adjusting screw and the valve stem.

Clearance should be:

Intake: 0.003" in

Exhaust: 0.005" in

6. If it is necessary to make an adjustment, loosen the adjusting screw lock nut and turn the adjusting screw so there is a slight resistance when the feeler gauge is inserted.

After completing the adjustment, tighten the adjusting screw lock nut while holding the adjusting screw to prevent it from turning. Finally, recheck the clearance to make sure that the adjustment has not been disturbed.

7. Check that the mount rubbers in good condition. Install the mount rubbers onto the cylinder head cover with the “UP” mark facing up. Install a new gasket onto cylinder head cover. Install the cylinder head. Install and tighten the cylinder head cover bolts.

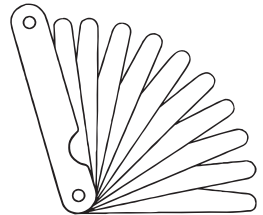
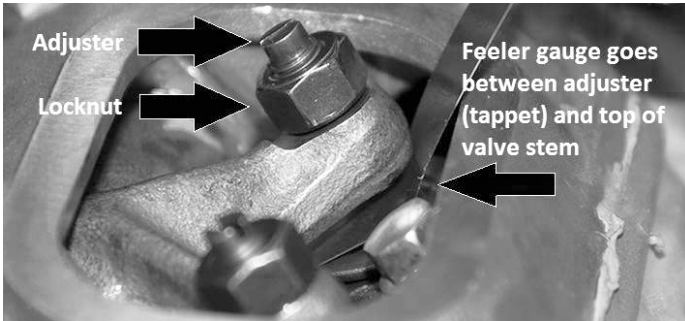

Feeler Gauge

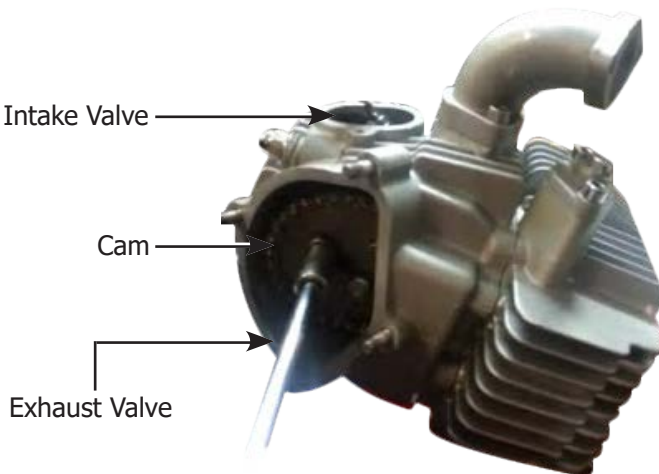

The engine must be at normal operating temperature for accurate idle speed adjustment. Ten minutes of stop-and-go riding is sufficient.



Do not attempt to compensate for faults in other systems by adjusting idle speed. See your **Certified Motorcycle Mechanic** for regularly schedule carburetor adjustments.

1. Warm up the engine, shift to neutral and place the motorcycle on its stand.
2. Adjust idle speed screw with a screw driver.

Idle Speed: $1,400 \pm 100$ rpm

SPARK PLUG RECOMMENDATION

The recommended standard spark plug is satisfactory for most riding conditions.

Brand / Model	
---------------	--

Use only the recommended type of spark plugs in the recommended heat range.

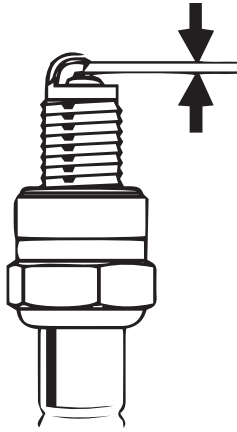

NOTICE:

Using spark plugs with an improper heat range can cause engine damage.

1. Clean any dirt from around the spark plug base.
2. Disconnect the spark plug cap.
3. Remove the spark plug with a plug wrench.
4. Inspect the spark plug electrodes for wear. The center electrode should have square edges. The side electrode should not be eroded. The insulator should not be cracked or chipped.

5. Check the spark plug gap, using a wiretype feeler gauge. If adjustment is necessary, bend the side electrode carefully. The gap should be: 0.03-0.04 in (0.8-0.9 mm) Make sure the plug washer is in good condition. If you have to install a new plug, first check the gap.
6. With the plug washer attached, thread the spark plug in by hand (to prevent crossthreading).
7. Tighten the spark plug:
 - If the old plug is good: 1/6 turn after it seats.
 - If installing a new plug, tighten it twice to prevent loosening:
 - a) First, tighten the plug: NGK: 1/4 turn after it seats.
 - b) Then loosen the plug.
 - c) Next, tighten the plug again: 1/6 turn after it seats.

NOTICE:

An improperly tightened spark plug can damage the engine. If a plug is too loose, a piston may be damaged. If a plug is too tight, the threads may be damaged.

8. Reinstall the spark plug cap. Take care to avoid pinching any cables or wires.

Note: An improperly tightened spark plug can damage the engine. If a plug is too loose, a piston may be damaged. If a plug is too tight, the threads may be damaged.

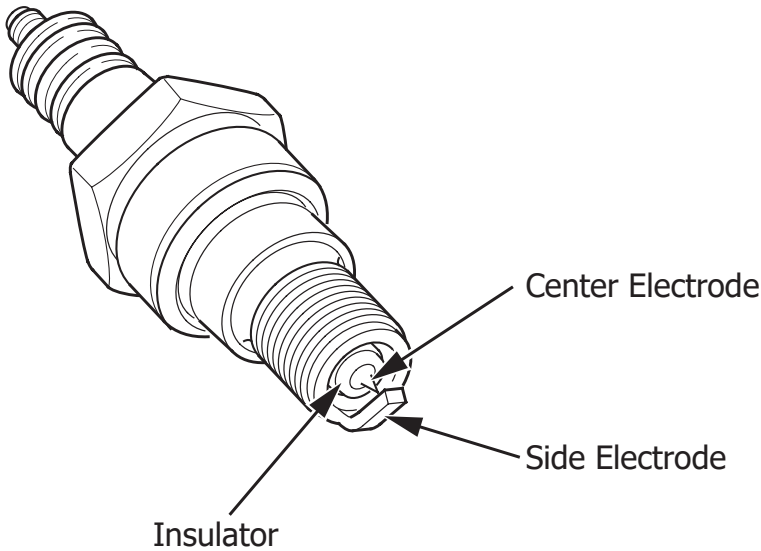

SPARK PLUG COLORING GUIDELINES

Condition	Spark Plug Appearance	Mixture
Normal	Dark Brown to Light Tan color with Dry Electrode	Correct
Overheating (Lean)	Light Gray or White Color	Lean
Wet (Rich)	Wet or Sooty	Rich

Remember that in addition to improper jetting:

- A lean condition can be caused by air leaks in the inlet tract or exhaust system, the passage of too much air because of the use of the wrong air cleaner, use of a less-restrictive aftermarket exhaust system, or a hole or holes (deliberate or unintentional) in the air box.
- A rich condition can be caused by a plugged or dirty air cleaner, use of a more-restrictive aftermarket exhaust system, a clogged spark arrester, or excessive oil on the air cleaner. Excessive smoking will occur.

Loose, worn, or damaged suspension components may adversely affect the handling and stability of your motorcycle. If any suspension components appear worn or damaged, see your **Certified Motorcycle Mechanic** for further inspection. Your **Certified Motorcycle Mechanic** is qualified to determine whether or not replacement parts or repairs are needed.

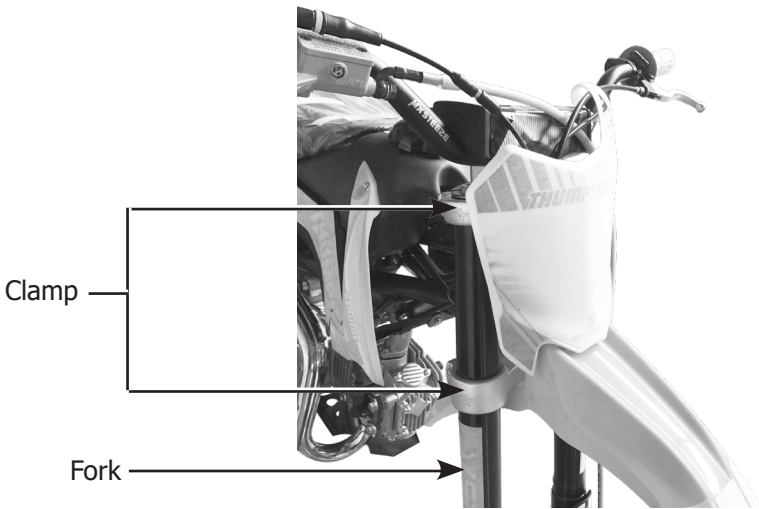

FRONT SUSPENSION INSPECTION

1. Check fork operation. Pull the front brake lever in, to lock the brake. Then pump up and down on the fork legs several times. The suspension should function smoothly. There should be no oil leakage.
2. Check the security of all handlebar and fork mounting bolts. If any front suspension components appear worn or damaged, see your **Certified Motorcycle Mechanic** for further inspection.

REAR SUSPENSION INSPECTION



Shock Absorber Attachment Points

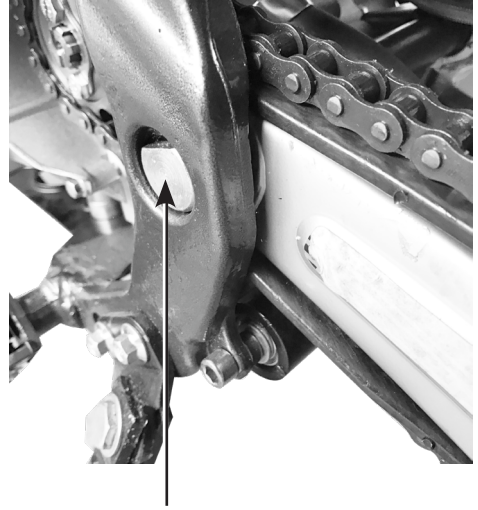

Swingarm Axle

1. Place the motorcycle on a maintenance stand. Push hard against the side of the rear wheel and feel for any freeplay which indicates worn swingarm bushings.
2. Check that the fasteners for the shock absorber attachment points are secure.
3. Check for oil leaks in the shock absorber. If any rear suspension components appear worn or damaged, see your **Certified Motorcycle Mechanic** for further inspection.

FRONT BRAKE LEVER

The front brake is the hydraulic disc type. As the brake pads wear, the brake fluid level will drop. A leak in the system will also cause the level to drop.

Frequently inspect the system to ensure there are no fluid leaks. Periodically inspect the brake fluid level and the brake pads for wear.

If the front brake lever freeplay does not feel within the normal range while riding, check the brake pads. If they are not worn beyond the recommended limit, there is probably air in the brake system. See your **Certified Motorcycle Mechanic** dealer to have the air bled from the system.

FLUID LEVEL INSPECTION

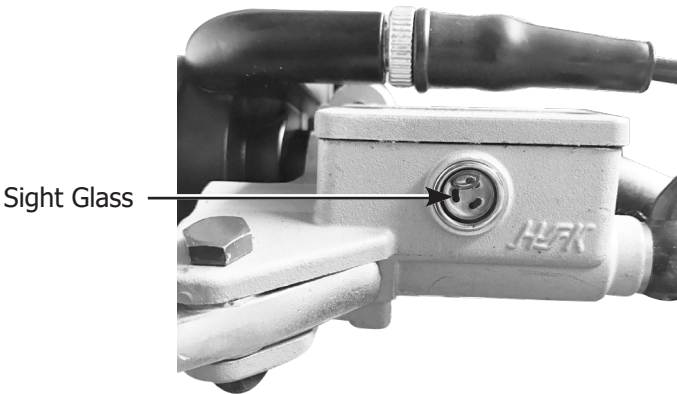

With the motorcycle in an upright position, check the fluid level. It should be above the LOWER level mark. If the level is at or below the LOWER level mark, check the brake pads for wear.

Worn brake pads should be replaced. If the pads are not worn, have your brake system inspected for leaks.

BRAKE PAD WEAR

Brake pad wear depends on the severity of usage, the type of riding, and riding area conditions. (Generally, the pads will wear faster on wet and dirty riding terrain.) Inspect the pads at each regular maintenance interval.

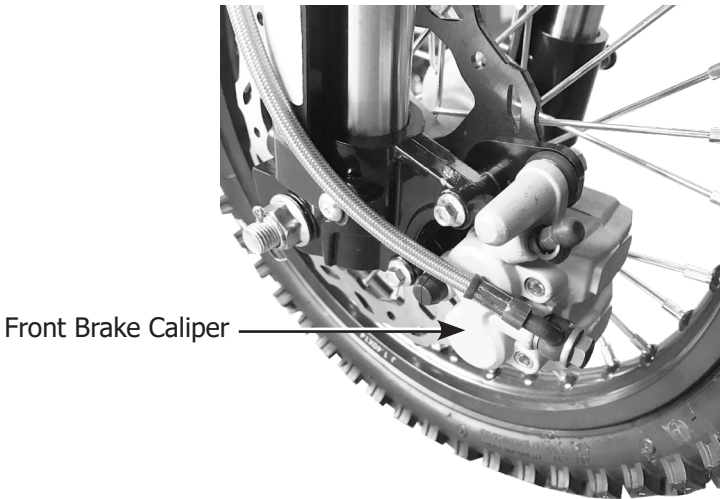

Check the cutout in each pad. If either pad is worn to the cutout, replace both pads as a set. See your **Certified Motorcycle Mechanic** for this service.

Check that the front lever assembly is positioned properly and the securing bolts are tight.

Brake fluid should be added and replaced by your **Certified Motorcycle Mechanic** dealer.

REAR BRAKE PEDAL FREEPLAY

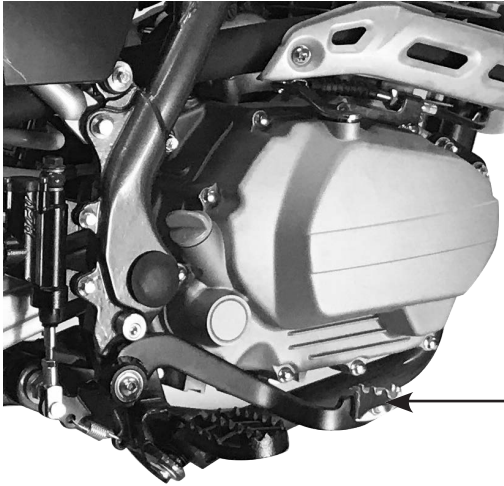

Rear Brake Pedal

1. Place your motorcycle on its side stand.
2. Check freeplay by slowly depressing the brake pedal until the brake starts to engage

REAR BRAKE PEDAL HEIGHT ADJUSTMENT

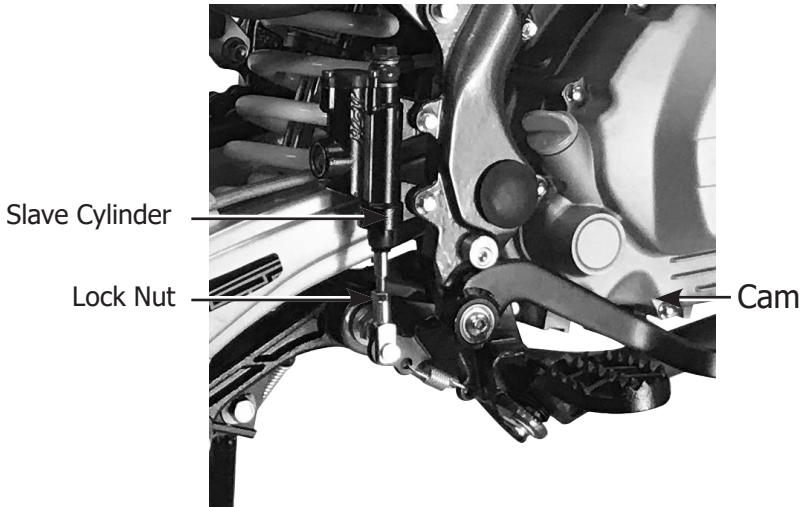

1. Loosen lock nut to adjust brake pedal to make it more tight or loose.
2. Loosen cam bolt and turn cam around to raise or lower brake pedal.

Keeping the wheels true (round) and maintaining correct spoke tension is critical to safe motorcycle operation. During the first 100 miles (150 km), spokes will loosen more rapidly due to the initial seating of the parts. Excessively loose spokes may result in instability at high speeds and the possible loss of control. Loose spokes may also cause rim or spoke damage. It's also important that the rim locks are secure to prevent tire slippage.

It is not necessary to remove the wheels to perform the recommended service in the Maintenance Schedule. However, information for wheel removal is provided for emergency situations.

WHEEL RIMS & SPOKES



1. Inspect the wheel rims and spokes for damage.
2. Tighten any loose spokes. To do a general wheel spoke tightening, mark the first spoke with a marker then tighten every 4th spoke. When back at the start move to the next spoke and repeat the process. This process will help avoid the rim becoming buckled. (This should be performed by a qualified mechanic)
3. Rotate the wheel slowly to see if it appears “wobble.” If it does, the rim is out of round or not “true.” If the wobble is noticeable, see your **Certified Motorcycle Mechanic** for inspection.

FRONT WHEEL REMOVAL

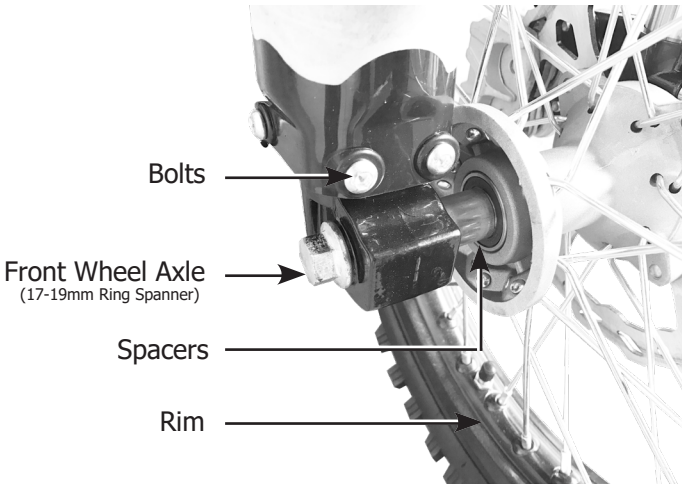

1. Raise the front wheel off the ground by placing a maintenance stand or support block under the engine. Secure the rear of the motorcycle with tie-down straps.
2. Remove the axle nuts and the axle holder using a 17-19mm ring spanner.
3. Unscrew and remove the front axle shaft.
4. Remove the wheel and side collars/spacers

Avoid depressing the brake lever when the wheel is off the motorcycle. This will force the caliper pistons out of the cylinders. The result will be loss of brake fluid. If this occurs, the brake system will require service. See your **Certified Motorcycle Mechanic** for this service.



FRONT WHEEL INSTALLATION

1. Reverse the removal procedure. Install the side collars into the wheel.
2. Insert the front axle shaft through the wheel hub and left fork leg.
3. Tighten the front axle shaft to the specified
Torque: 54 lbf·ft (73.5 N·m, 7.5 kgf·m)
4. Operate the front brake and pump the fork several times.
5. Install split pin/cotter pin.
6. After installing the wheel, apply the brake several times and then check if the wheel rotates freely. Recheck the wheel if the brake drags or if the wheel does not rotate freely. Check front brake adjustment

If a torque wrench was not used to install the wheel, see your **Certified Motorcycle Mechanic** as soon as possible to verify proper assembly. Improper assembly may lead to loss of braking capacity.

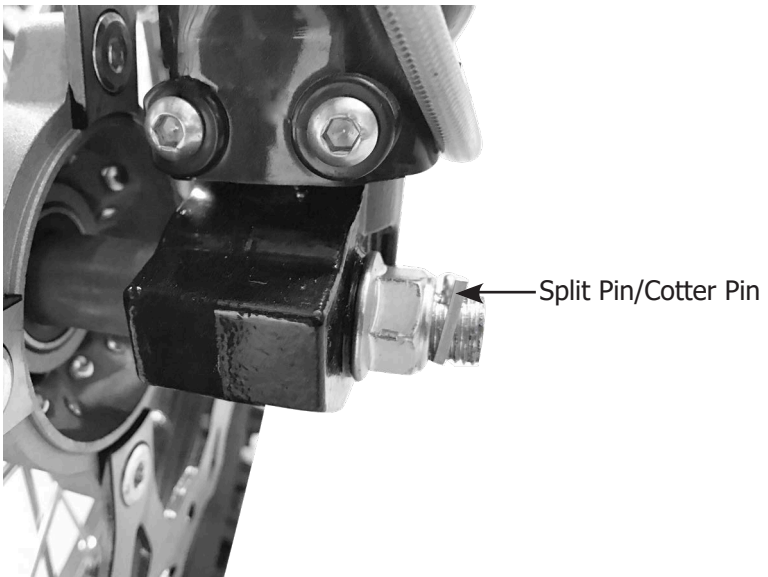

REAR WHEEL REMOVAL

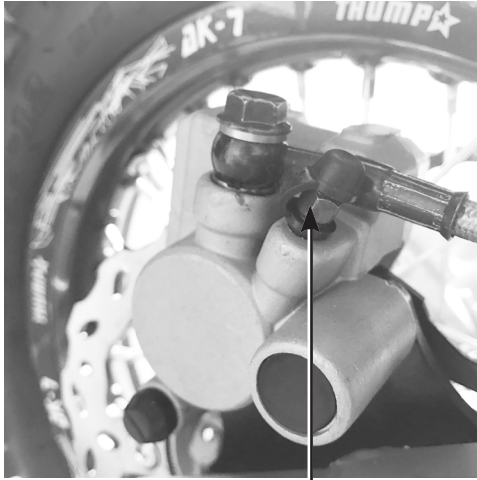

Bleed Screw

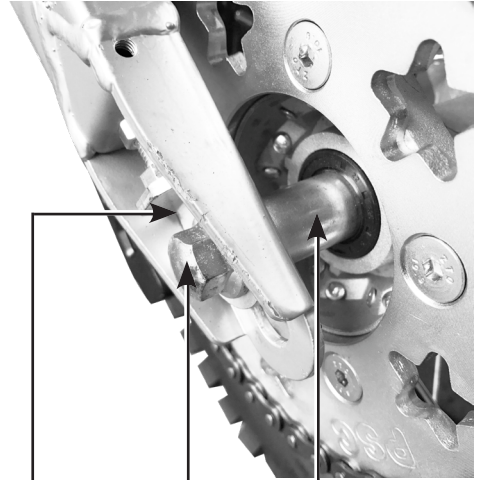

Rear Axle Shaft

Rear Axle Nut

Chain Adjusters

1. Raise the rear wheel off the ground by placing a maintenance stand or support block under the engine. Secure the front of the motorcycle with tie-down straps.
2. Remove the rear brake adjusting nut using a 17-19mm ring spanner.
3. Loosen the rear axle nut while holding the rear axle shaft.
4. Turn both chain adjusters so the rear wheel can be moved all the way forward for maximum drive chain slack.
5. Unscrew the rear axle nut. Pull the rear axle shaft out. Push the wheel forward and derail the drive chain from the rear sprocket. Remove the wheel and side collar.
6. Take care to prevent getting grease, oil, or dirt on the brake shoe surfaces. This can cause poor brake performance or rapid brake shoe wear after reassembly.

REAR WHEEL INSTALLATION

1. Reverse the removal procedure. Install the side collar into the wheel.
2. Adjust the drive chain.
3. Tighten the rear axle nut to the specified
Torque: 80 lbf·ft (108 N·m , 11.0 kgf·m)
4. Adjust the rear brake.
5. Apply the rear brake, release it, then spin the wheel and check that it rotates freely. Repeat this procedure several times.

If a torque wrench was not used to install the wheel, see your **Certified Motorcycle Mechanic** dealer as soon as possible to verify proper assembly. Improper assembly may lead to loss of braking capacity.

Side Stand

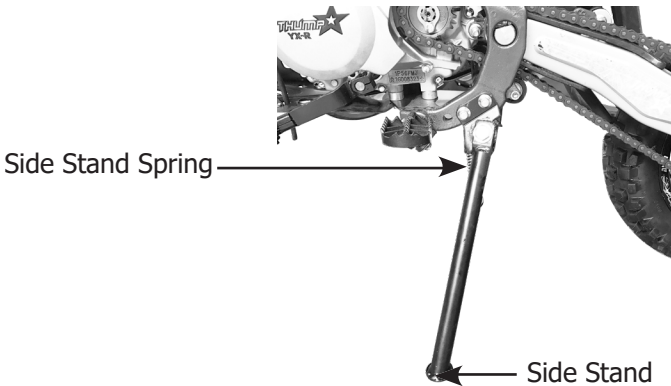

1. Check the side stand spring for damage Safety Precautions and loss of tension.
2. Check the side stand assembly for freedom of movement.

If the side stand is stiff or squeaky, clean the pivot area and lubricate the pivot bolt with clean engine oil.

To safely operate your motorcycle, the tires must be the proper type (off-road) and size, in good condition with adequate tread, and correctly inflated.

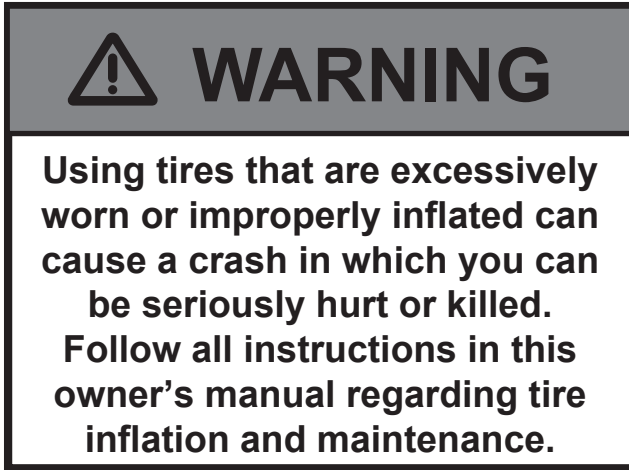

The following pages give detailed information on how and when to check your air pressure, how to inspect your tires for wear and damage, and our recommendations on tire repair and replacement.

AIR PRESSURE

Properly inflated tires provide the best combination of handling, tread life, and riding comfort. Generally, underinflated tires wear unevenly, adversely affect handling, and are more likely to fail from being overheated. Underinflated tires can also cause wheel damage in rocky terrain. Overinflated tires make your motorcycle ride harshly, are more prone to damage from surface hazards, and wear unevenly.

Make sure the valve stem caps are secure. If necessary, install new caps.

Always check air pressure when your tires are “cold.” If you check air pressure when your tires are “warm” even if your motorcycle has only been ridden for a few miles the readings will be higher. If you let air out of warm tires to match the recommended cold pressures, the tires will be underinflated. The correct “cold” tire pressures are:

Front	20 psi (138 kPa , 1.4 kgf/cm)
Rear	20 psi (138 kPa , 1.4 kgf/cm)

If you decide to adjust tire pressures for a particular riding condition, make changes a little at a time.

INSPECTION

A flat tire or blowout is inconvenient and may even cause a crash. Take time to inspect your tires and wheels before you ride.

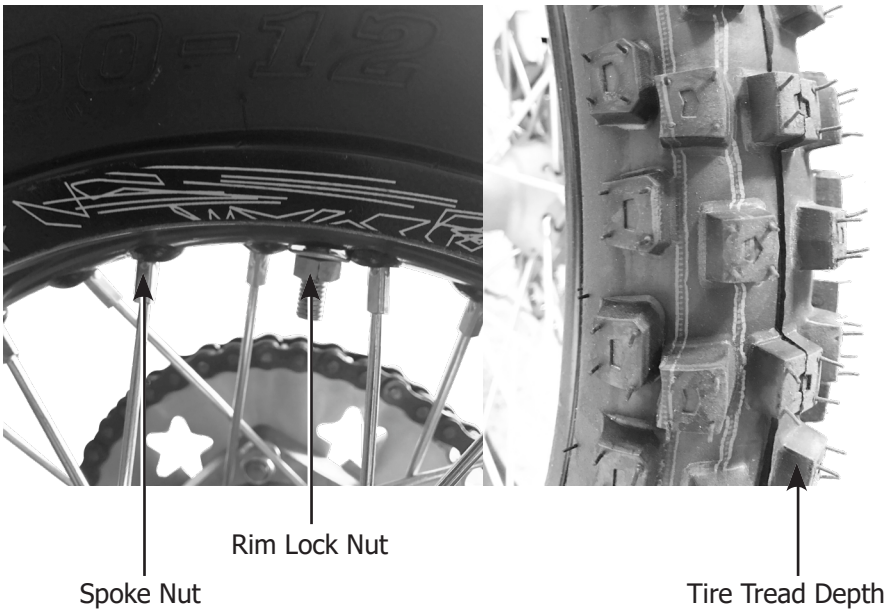

- Inspect carefully for bumps or bulges in the side of the tire or the tread. Replace any tire that has a bump or bulge.
- Look closely for cuts, slits, or cracks in the tires. Replace a tire if you can see fabric or cord.
- Check for rocks or other objects embedded in the tire or tread. Remove any objects.
- Measure tread depth. Replace the tire before depth at the center reaches 0.12 in (3 mm), or any time you notice a reduction in traction.
- Check the position of both valve stems. A tilted valve stem indicates the tube is slipping inside the tire or the tire is slipping on the rim. See your **Certified Motorcycle Mechanic**.

TUBE REPLACEMENT

If a tube is punctured or damaged, you should replace it as soon as possible. A repaired tube may not have the same reliability as a new one, and it may fail while you are riding.

Use a replacement tube equivalent to the original.

We recommend that tubes be replaced by your **Certified Motorcycle Mechanic**. Replacing a tube requires removing and reinstalling the wheel. Any time a tube is replaced, carefully inspect the tire as described on INSPECTION.

TIRE REPLACEMENT

The tires that came on your motorcycle were designed to provide a good combination of handling, braking, durability, and comfort across a broad range of riding conditions.

 **WARNING**

Installing improper tires on your motorcycle can affect handling and stability. This can cause a crash in which you can be seriously hurt or killed. Always use the size and type of tires recommended in this owner's manual.

TSF 189

Front	70/100-19
Rear	90/100-16
Type	bias-ply, tube

TSF 230

Front	80/100-21
Rear	100/90-18
Type	bias-ply, tube

- Use a replacement tire equivalent to the original.
- Replace the tube any time you replace a tire. The old tube will probably be stretched and, if installed in a new tire, could fail.
- Have the wheel balanced after a new tire is installed.
- We recommend that tires be replaced by your **Certified Motorcycle Mechanic**.

The service life of the chain depends on proper lubrication and adjustment. Poor maintenance can cause premature wear or damage to the drive chain or sprockets.

Under severe usage, or when the motorcycle is ridden in unusually dusty or muddy areas, more frequent maintenance will be necessary.

Before servicing your drive chain, turn the engine OFF, lower the side stand, and check that your transmission is in neutral.

It is not necessary to remove or replace the drive chain to perform the recommended service in the Maintenance Schedule.

INSPECTION



1. Check slack in the lower drive chain run midway between the sprockets. Drive chain slack should allow the following vertical movement by hand: 10 - 20mm
2. Check drive chain slack at several points along the chain. The slack should remain constant. If it isn't, some links may be kinked and binding. Lubricating the chain will often eliminate binding and kinking.

Excessive chain slack may allow the drive chain to damage the engine cases.

3. Inspect the drive chain for:

- damaged rollers
- loose pins
- dry or rusted links
- kinked or binding links
- excessive wear

Replace the drive chain if it has damaged rollers, loose pins, or kinks that cannot be freed. Lubricate the drive chain if it appears dry or shows signs of rust. Lubricate any kinked or binding links and work them free. Adjust chain slack if needed.

4. Check the chain slider for wear. If the ridge in the center of the slider is worn, have your **Certified Motorcycle Mechanic** replace the chain slider.
5. Replace the drive chain if chain slack is excessive when the rear axle is moved to the farthest limit of adjustment. Excessive slack indicates the chain is worn beyond its service limit. To check the chain's service limit, remove the drive chain . Then measure the distance between a span of 86 pins, from pin center to pin center. If the distance exceeds the service limit, the drive chain is worn out and should be replaced.
6. Inspect the front and rear sprocket teeth for excessive wear or damage. If necessary, have your **Certified Motorcycle Mechanic** replace a worn sprocket.

NOTICE:

Use of a new chain with worn sprockets will cause rapid chain wear.

Standard Chain 428x114 recommend using heavy duty type. (HD)

ADJUSTMENT

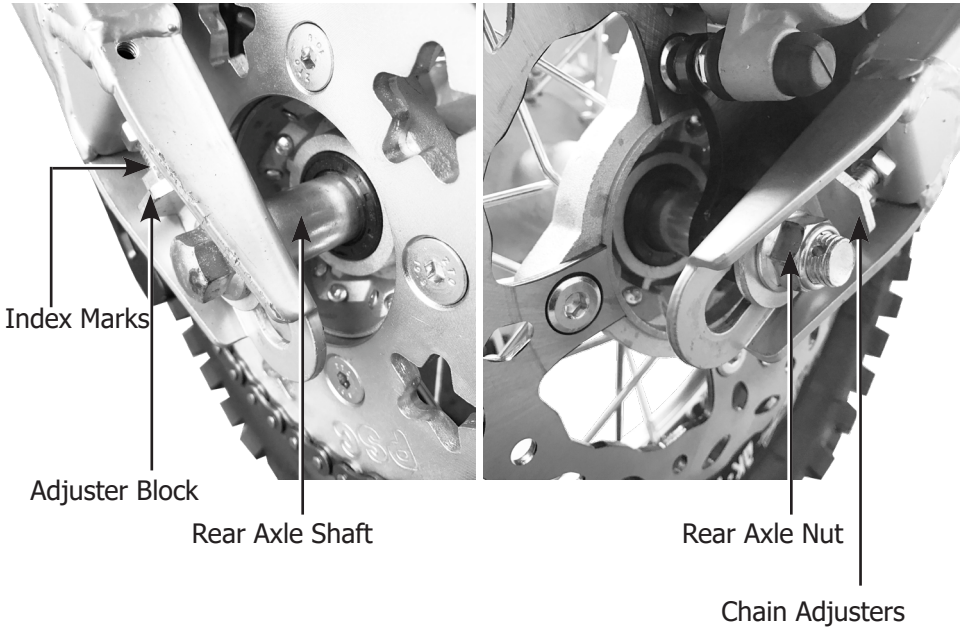

1. Hold the rear axle shaft and loosen the rear axle nut.
2. Loosen the lock nuts on both sides of the swingarm.
3. Turn both the right and left chain adjusters equally to increase or decrease chain slack.
4. After adjusting, be sure the same adjuster index marks align with the adjuster block on both sides of the swingarm.
5. Torque the rear axle nut to: 47 lbf·ft (64 N·m , 6.5 kgf·m)
6. Recheck drive chain slack.
7. Check rear brake pedal freeplay and adjust as necessary. Freeplay is affected when repositioning the rear wheel to adjust\drive chain slack.

If a torque wrench is not used for this installation, see your **Certified Motorcycle Mechanic** as soon as possible to verify proper assembly.

LUBRICATION

Lubricate every 300 miles (500 km) or sooner if chain appears dry. Turn the rear wheel by hand. Saturate each chain link joint so that the lubricant penetrates between the link plates, pins, bushings, and rollers. Lubricate with quality chain oil.

REMOVAL, CLEANING & REPLACEMENT

When the drive chain becomes extremely dirty, it should be removed and cleaned prior to lubrication.

1. Clean the side surfaces of the chain with a dry cloth.
2. Inspect the drive chain for possible wear or damage. Replace the drive chain if it has damaged rollers, loose fitting links, or otherwise appears unserviceable.

Replacement chain: 428 Chain and heavy duty

3. Inspect the sprocket teeth for wear or damage. We recommend replacing the sprocket whenever a new chain is installed.
5. Lubricate the drive chain.

MORE ABOUT: DRIVE CHAIN

- The master link is the most critical element of drive chain security. Master links are reusable, as long as they remain in excellent condition. We recommend installing a new master link retaining clip when the drive chain is reassembled.
- You may find it easier to install a new chain by connecting it to the old chain with a master link and pulling the old chain to position the new chain on the sprockets.

Frequent cleaning and polishing will keep your Thumpstar looking newer longer. Frequent cleaning also identifies you as an owner who values your motorcycle. A clean motorcycle is also easier to inspect and service.

While you're cleaning, be sure to look for damage, wear, and gasoline or oil leaks.

GENERAL RECOMMENDATIONS

- To clean your motorcycle, you may use:
 - Water
 - A mild, neutral detergent and water
 - A mild spray and wipe cleaner/polisher
 - A mild spray and rinse cleaner/degreaser and water
- Avoid products that contain harsh detergents or chemical solvents that could damage the metal, paint, and plastic on your motorcycle.
- If your motorcycle is still warm from recent operation, give the engine and exhaust system time to cool off.
- We recommend the use of a garden hose to wash your motorcycle. High pressure washers (like those at coin-operated car washes) can damage certain parts of your motorcycle. If you use a high pressure washer, avoid spraying the following areas:
 - air filter
 - wheel hubs
 - muffler outlet
 - area under seat
 - engine stop switch
 - under fuel tank
 - carburetor
 - drive chain

NOTICE:

High pressure water (or air) can damage certain parts of your motorcycle.

WASHING YOUR MOTORCYCLE WITH A MILD DETERGENT

1. Rinse your motorcycle thoroughly with cool water to remove loose dirt.
2. Fill a bucket with cool water. Mix in a mild, neutral detergent, such as dish washing liquid or a product made especially for washing motorcycles or automobiles.
3. Wash your motorcycle with a sponge or a soft towel. As you wash, check for heavy grime. If necessary, use a mild cleaner/ degreaser to remove the grime.
4. After washing, rinse your motorcycle thoroughly with plenty of clean water to remove any residue.
5. Dry your motorcycle with a chamois or a soft towel. Leaving water on the surface to air dry can cause dulling and water spots. As you dry, inspect for chips and scratches.
6. Lubricate the drive chain to prevent rusting.
7. Start the engine and let it idle for several minutes. The engine heat will help dry moist areas.
8. As a precaution, ride at a slow speed and apply the brakes several times. This will help
9. dry the brakes and restore normal braking
10. performance.

EXHAUST PIPE AND MUFFLER MAINTENANCE

When the exhaust pipe and muffler are painted, do not use a commercially available abrasive kitchen cleaning compound. Use a neutral detergent to clean the painted surface on the exhaust pipe and muffler. If you are not sure if your exhaust pipe and muffler are painted, contact your dealer.

TIPS

Here's helpful advice on how to prepare for an off-road adventure, how to transport and store your Thumpstar unit, and how to be an environmentally responsible motorcycle owner.

Spraying WD40 or similar product on metal parts will help protect the motorcycle (*never spray WD40 near the brakes*)

A safe and enjoyable ride begins with good planning and preparation. Always ride with at least one other person in case you have trouble, and let someone know where you're going and when you expect to return.

Before riding in an unfamiliar area, find out in advance if you need special permits, get maps so you can study the terrain, and talk to other riders who know the area. The Forest Service and the Bureau of Land Management (USA only), the Ministry of Natural Resources (Canada only), riding clubs, and off-road magazines are good sources of information.

WHAT TO TAKE TO THE RIDING AREA

Along with your motorcycle and riding gear, you should take along some tools and supplies in case you have a problem.

We recommend that you always take water, food, a first aid kit, and your owner's manual. Other items you should consider loading on your truck or trailer include:

- a tool kit
- tire repair supplies and tools, tubes, and tires
- extra parts, such as a drive chain and master links, control levers, air filter, cables, and spark plugs
- wire, duct tape, and rope
- extra gasoline

For safety, all refueling should be done at a gas station on the way to the riding area or at your base camp.

If you use a truck or motorcycle trailer to transport your Thumpstar, we recommend that you follow these guidelines:

- Use a loading ramp.
- Make sure the fuel valve is off.
- Secure the motorcycle in an upright position, using motorcycle tie-down straps. Avoid using rope, which can loosen and allow the motorcycle to fall over.

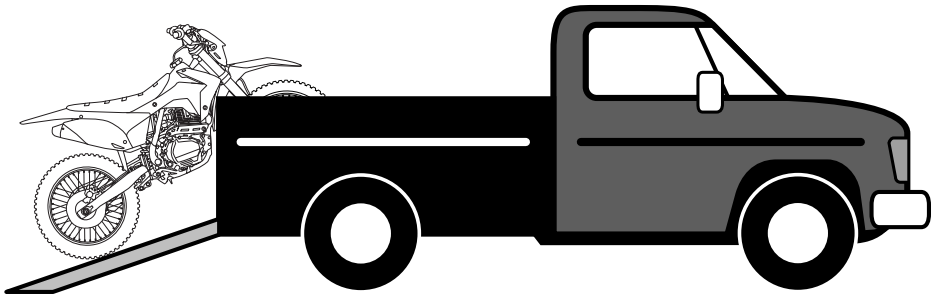

To secure your Thumpstar motorcycle, brace the front wheel against the front of the truck bed or trailer rail. Attach the lower ends of two straps to the tie-down hooks on your motorcycle. Attach the upper ends of the straps to the handlebar (one on the right side, the other on the left), close to the fork.

WHAT TO TAKE ON THE TRAIL

What you take with you during a ride depends on the kind of terrain, how long you expect to ride, how far you might go from your base camp or help, and how experienced you or your companions are in making repairs.

If you decide to take some tools, spare parts, or other supplies on the trail, be sure you can carry them safely and know how to use them. Also, be sure to follow the loading guidelines and weight limit.

Check that the tie-down straps do not contact any control cables or electrical wiring.

Tighten both straps until the front suspension is compressed about half-way. Too much pressure is unnecessary and could damage the fork seals.

Use another tie-down strap to keep the rear of the motorcycle from moving.

We recommend that you do not transport your motorcycle on its side. This can damage the motorcycle, and leaking gasoline could be a hazard.

STORING YOUR THUMPSTAR MOTORCYCLE

If you won't be riding for an extended period, such as during the winter, thoroughly inspect your motorcycle and correct any problem before storing it. That way, needed repairs won't be forgotten and it will be easier to get your motorcycle running again.

PREPARATION FOR STORAGE

1. Change the engine oil
2. Fill the fuel tank. Make sure the fuel fill cap is properly installed.
3. Check that the fuel valve is OFF.
4. Drain the carburetor into an approved gasoline container and dispose of it in an approved manner. If storage will last longer than one month, carburetor draining is important, to assure proper performance after storage.

5. Store it in an area protected from freezing temperatures and direct sunlight.
6. Wash and dry your motorcycle.
7. Lubricate the drive chain.
8. Inflate the tires to their recommended pressures
9. Store your motorcycle in an unheated area, free of dampness, away from sunlight, with a minimum of daily temperature variation.
10. Cover your motorcycle with a porous material. Avoid using plastic or similar nonbreathing, coated materials that restrict air flow and allow heat and moisture to accumulate.

REMOVAL FROM STORAGE

1. Uncover and clean your motorcycle.
2. If your motorcycle has been stored for more than four months change the engine oil
3. If your motorcycle has been stored for more than two months drain and replace the fuel.
4. Lubricate the drive chain
5. Perform a pre-ride inspection, then test-ride your motorcycle at low speeds.

The items that are serviceable using this Manual are followed by the page number reference in parenthesis. The items that require use of the Thumpstar Manual are followed by an asterisk.

POOR PERFORMANCE AT LOW AND UNSTABLE IDLE SPEED

CHECK

POSSIBLE CAUSES

1. Check if air cleaner is over-oiled (P-43)

INCORRECT

- Over-oiled air cleaner.

CORRECT

2. Check if the intake *tube is leaking*

LEAKING

- Loose insulator clamp
- Damaged insulator

NOT LEAKING

3. Check carburetor pilot screw *adjustment (P-126)*

INCORRECT

- Fuel-air mixture too lean (Turn the pilot screw out) (P-126)
- Fuel-air mixture too rich (Turn the pilot screw in) (P-126)

CORRECT

4. Check carburetor jets and accelerator pump for clogs

BLOCKED

- Contaminants in the fuel
- Not cleaned frequently enough (P-119)

NOT BLOCKED

5. Try spark test

GOOD SPARK

**WAKE OR
INTERMITTENT
SPARK**

- Faulty, carbon or wet fouled spark plug (P-55)
- Faulty ignition control module*
- Faulty alternator*
- Faulty ignition coil*
- Broken or shorted spark plug wire.
- Faulty ignition pulse generator*.

6. Check for low compression.

CORRECT

LOW

- Ring worn
- Cylinder worn or damaged
- Piston worn or damaged
- Head gasket not sealing

POOR PERFORMANCE AT LOW AND UNSTABLE IDLE SPEED CHECK

1. Disconnect fuel line at carburetor and check for clogging (P-34)

**UNRESTRICTED
FUEL FLOW**

**FUEL FLOW
RESTRICTED**

POSSIBLE CAUSES

- Lack of fuel in tank (P-34)
- Clogged fuel line (P-34)
- Clogged fuel fill cap breather tube (P-34)
- Clogged fuel valve (P-34)
- Clogged fuel filter (P-35)

2. Remove air cleaner (P-43)

**AIR FILTER
NOT DIRTY**

DIRTY

- Not cleaned frequently enough (P-43)

3. Install a larger carburetor main jet (P-126)

CORRECT

CONDITION WORSE

- Jet size wrong, rejet in the opposite direction (P-126)

4. Check carburetor jets for clogging

NOT BLOCKED

BLOCKED

- Contaminants in the fuel

5. Check valve timing

CORRECT

INCORRECT

- Cam sprocket not installed properly

6. Try spark test

GOOD SPARK

WEAK OR INTERMITTENT SPARK

- Faulty, carbon or wet fouled spark plug (P-55)
- Faulty ignition control module*
- Faulty alternator*
- Faulty ignition coil*
- Broken or shorted spark plug wire.
- Faulty ignition pulse generator*.

7. Check for low compression.

CORRECT

LOW

- Ring worn
- Cylinder worn or damaged
- Piston worn or damaged
- Head gasket not sealing

Owning and riding a motorcycle can be enjoyable, but you must do your part to protect nature. When you show respect for the land, wildlife, and other people, you also help preserve the sport of off-road riding.

Following are tips on how you can be an environmentally responsible motorcycle owner.

Tread Lightly - Stay on existing roads and trails, avoid surfaces that are easily damaged, and ride only in areas approved for off-road motorcycles

Keep the Noise Down - Loud motorcycles can be offensive. Ride as quietly as possible, don't modify the muffler or any other part of your air intake and exhaust systems. Such modifications not only increase noise, they also reduce engine performance and may be illegal.

Choose Sensible Cleaners - Use a biodegradable detergent when you wash your motorcycle. Avoid aerosol spray cleaners that contain chlorofluorocarbons (CFCs) which damage the atmosphere's protective ozone layer. Don't throw cleaning solvents away; see the following guidelines for proper disposal.

RecycleWastes - It's illegal and thoughtless to put used engine oil in the trash, down a drain, or on the ground. Used oil, gasoline, and cleaning solvents contain poisons that can hurt refuse workers and contaminate our drinking water, lakes, rivers, and oceans. Before changing your oil, make sure you have the proper containers. Put oil and other toxic wastes in separate sealed containers and take them to a recycling center. Call your local or state office of public works or environmental services to find a recycling center in your area and get instructions on how to dispose of non-recyclable wastes.

With all the challenges you can encounter offroad, there's a chance that sometime something may go wrong. This section gives practical advice to help you deal with a wide range of problems. Take time to read this section before you ride.

GENERAL GUIDELINES

If something goes wrong during a ride, the first thing to do is stop as soon as you safely can. Do not continue riding if you have a flat tire, or you hear an unusual noise, or your motorcycle just doesn't feel right. If you continue riding, you could cause more damage and endanger your own safety.

After a stop, take time to assess the situation. Carefully inspect your motorcycle to identify the problem, then consider your options before you decide what to do.

If a problem is relatively minor and you have the tools, supplies, and skills to make a permanent repair, you may be able to fix it on the trail and continue riding. Or, you may be able to make a temporary repair that allows you to slowly ride back to your base where you can make a permanent repair or get help.

When a problem is more serious or you don't have the tools, supplies, experience, or time to deal with it you need to choose the safest way to get yourself and your motorcycle back to base. For example, if you are close enough, you (or you and another person) might be able to push it back.

Whatever the problem, the most important rules are:

- Always put personal safety first.
- If you made temporary repairs, be sure to have permanent repairs made as soon as possible.
- Do not continue riding if you are hurt or your motorcycle is not in safe riding condition.

Additional recommendations for specific problems follow.

IF YOUR ENGINE QUILTS OR WON'T START

If you have a problem starting the engine or experience poor engine performance the following information may help you. If you can't correct the problem, see or talk to your Thumpstar **Certified Motorcycle Mechanic**.

SYMPTOM	Engine starts, but runs poorly.
POSSIBLE CAUSE	WHAT TO DO
idles roughly, too fast, stalls	Check engine idle adjustment. Check fuel hose is not blocked. If the problem persists, see or talk to your Thumpstar Certified Motorcycle Mechanic .
runs erratically, misfires	See or talk to your Thumpstar Certified Motorcycle Mechanic .
blubbers (rich fuel mixture)	See or talk to your Thumpstar Certified Motorcycle Mechanic .
sooty exhaust (rich fuel mixture)	See or talk to your Thumpstar Certified Motorcycle Mechanic .
detonates or pings under load	If applicable, switch to the recommended octane gasoline or change your brand of gasoline. If the problem persists, see your Certified Motorcycle Mechanic .
afterfires (backfires)	See or talk to your Thumpstar Certified Motorcycle Mechanic .
pre-ignition (runs on after ignition switched OFF)	See or talk to your Thumpstar Certified Motorcycle Mechanic .

SYMPTOM	Fuel leaks from carburetor overflow
POSSIBLE CAUSE	WHAT TO DO
float not adjusted right	Remove carburetor and adjust float correctly
debris blocking fuel shut-off valve	Remove carburetor and clean the jet

SYMPTOM	Does not start / kick start
POSSIBLE CAUSE	WHAT TO DO
faulty kill switch	Disconnect kill switch
no fuel	Check carburetors getting fuel by removing drain screw
no spark	Remove spark plug and do a spark test

IF YOU HAVE A FLAT TIRE

How you handle a flat tire on the trail depends on how serious the tube or tire damage is, and what tools and supplies you have with you.

If you have a slow leak or a minor puncture, there are two ways to try making a temporary repair:

- Use an aerosol tire sealer to seal the puncture and inflate the tube. (This can be done without removing the tire or wheel.)
- Use a tube patch kit to repair the puncture. (This requires removing the tire.)

If the leak is more serious, or a temporary repair doesn't hold, the tube must be replaced. The tire will also need to be replaced if it is damaged. Replacing a tube or tire involves removing and re-installing the wheel.

If you are unable to repair a flat tire on the trail, you will need to push the motorcycle back to your base or send for help. We strongly recommend that you do not try to ride with a flat tire. The motorcycle will be hard to handle, and if the tire comes off the rim, it may lock up the wheel and cause you to crash.



WARNING

Riding your motorcycle with a temporary tire repair can be risky. If the temporary repair fails, you can crash and be seriously injured or killed. If you must ride with a temporary tire repair, ride slowly and carefully until the tire is permanently repaired or replaced.

IF YOU CRASH

Personal safety is your first priority after a crash. If you or anyone else has been injured, take time to assess the severity of the injuries and whether it is safe to continue riding. If you cannot ride safely, send someone for help. Do not ride if you will risk further injury.

If you decide that you are capable of riding safely, first evaluate the condition of your motorcycle. If the engine is still running, turn it off and look it over carefully; inspect it for fluid leaks, check the tightness of critical nuts and bolts, and secure such parts as the handlebar, control levers, brakes, and wheels.

If there is minor damage, or you are unsure about possible damage but decide to try riding the motorcycle back to your base, ride slowly. Personal safety is your first priority after a crash and cautiously.

Sometimes, crash damage is hidden or not immediately apparent. When you get home, thoroughly check your motorcycle and correct any problems you find. Also, be sure to have your **Certified Motorcycle Mechanic** check the frame and suspension after any serious crash.

IF A COMPONENT FAILS

The drive chain, master link, brake lever or pedal, control cables, and other components can be damaged as you ride in dense brush or over rocky terrain. Making a trailside repair depends on how serious the damage is and what tools and supplies you have with you.

- If the drive chain comes off because the master link clip gets knocked off, you may be able to put the chain back on with a new master link. However, if the chain brakes or does other damage when it comes off, you may not be able to make a trailside repair.
- If any component of the front brake system is damaged, you may be able to ride carefully back to your base using the rear brake for slowing or stopping.
- If you damage a throttle cable or other critical component, your motorcycle may be unsafe to ride. Carefully assess the damage and make any repairs that you can. But if there is any doubt, it's best to be conservative and safe.

This section contains technical information by how to identify your motorcycle



VIN PLATE



ENGINE NUMBER

VIN: Vehicle Identification Number is a serial number to identify your Thumpstar

Engine: The first 6-7 digit is the engine model number, usually letters and numbers which purpose is for spare parts and detailed specifications. The 2nd group of numbers usually 9 digit is similar to your VIN which is a serial number to identify your particular engine.

“1P44FZB” engine model “160726227” engine serial number

Model No: To identify the model of your Thumpstar

Displacement: Engine size of your Thumpstar

Version No: To identify which version your model is, Thumpstar models are categorized by version number rather than by model year, so to find the correct OEM parts you will need the version number.

Tip: if a model is a version 1, 1.1, 1.2, 1.3 they are all in the same version family, meaning that 95% of the spare parts will be the same, usually a change in color or minor part like carburetor or exhaust system. If is a version 2, 2.1 then major components have been changed like plastics, frame or engine.

Max Weight: Maximum weight a rider can be to operate this motorcycle

Net Weight: The total weight of your motorcycle.

Date: This is the date of manufacture and does not determine the model year or version number

Some conventional gasolines are being blended with alcohol or an ether compound. These gasolines are collectively referred to as oxygenated fuels. To meet clean air standards, some areas of the United States and Canada use oxygenated fuels to help reduce emissions.

If you use an oxygenated fuel, be sure it is unleaded and meets the minimum octane rating requirement.

Before using an oxygenated fuel, try to confirm the fuel's contents. Some states/ provinces require this information to be posted on the pump.

The following are the EPA-approved percentages of oxygenates:

ETHANOL (ethyl or grain alcohol) 10% by Volume.

You may use gasoline containing up to 10% ethanol by volume. Gasoline containing ethanol may be marketed under the name "Gasohol"

MTBE (Methyl Tertiary Butyl Ether) 15% by Volume

You may use gasoline containing up to 15% MTBE by volume.

METHANOL (methyl or wood alcohol) 5% by Volume

You may use gasoline containing methanol containing up to 5% methanol by volume as long as it contains cosolvents and corrosion inhibitors to protect the fuel system. Gasoline containing more than 5% methanol by volume may cause starting and/or performance problems. It may also damage metal, rubber, and plastic parts of your fuel system.

If you notice any undesirable operating symptoms, try another service station or switch to another brand of gasoline.

Fuel system damage or performance problems resulting from the use of an oxygenated fuel containing more than the percentages of oxygenates mentioned above are not covered under warranty.

Oxygenated fuels can damage paint and plastic. Be careful not to spill fuel when filling the fuel tank. Wipe up any spills immediately.

TSF 150-X

ENGINE AND TRANSMISSION

Engine	TY150
CC Rating	150cc
Gearbox	Manual 5 speed(N12345)
Starter	Electric Kick
Carburetion	PE28
Exhaust	Pipe Bomb DW1 38mm Exhaust System
Final Drive	520 Chains

SUSPENSION, BRAKES AND WHEELS

Suspension Front	VS1 Adjustable Forks 830mm 53/58.5mm
Suspension Rear	Mono shock Length 450mm
Brakes Front	Hydraulic Disc Brake
Brakes Rear	Hydraulic Disc Brake
Wheel & Tyre Front	70/100-17
Wheel & Tyre Rear	90/100-14

DIMENSIONS AND WEIGHT

Wheelbase	1340mm 55"
Seat Height	880mm 35"
Carton Dimentions	1690X460X830mm .40 m3
Plastics/Graphics	BSE150
Weight (n.w/g.w)	110/120kg 243/265lbs
Tank Capacity	6.3 Litres 1.7gallon

TSF 170-X

ENGINE AND TRANSMISSION

Engine	
CC Rating	170cc
Gearbox	Manual 5 speed(N12345)
Starter	Electric Kick
Carburetion	PE28
Exhaust	Pipe Bomb DW1 38mm Exhaust System
Final Drive	520 Chains

SUSPENSION, BRAKES AND WHEELS

Suspension Front	VS1 Adjustable Forks 830mm 53/58.5mm
Suspension Rear	Mono shock Length 450mm
Brakes Front	Hydraulic Disc Brake
Brakes Rear	Hydraulic Disc Brake
Wheel & Tyre Front	80/100-17
Wheel & Tyre Rear	100/90-14

DIMENSIONS AND WEIGHT

Wheelbase	1340mm 55"
Seat Height	TBA
Carton Dimentions	1690X460X830mm .40 m3
Plastics/Graphics	BSE150
Weight (n.w/g.w)	110/120kg 243/265lbs
Tank Capacity	6.3 Litres 1.7gallon

TSF 189-X

ENGINE AND TRANSMISSION

Engine	
CC Rating	189cc
Gearbox	Manual 5 speed(N12345)
Starter	Electric Kick
Carburetion	PE28
Exhaust	Pipe Bomb DW1 38mm Exhaust System
Final Drive	520 Chains

SUSPENSION, BRAKES AND WHEELS

Suspension Front	VS1 Adjustable Forks 830mm 53/58.5mm
Suspension Rear	Mono shock Length 450mm
Brakes Front	Hydraulic Disc Brake
Brakes Rear	Hydraulic Disc Brake
Wheel & Tyre Front	80/100-19
Wheel & Tyre Rear	100/90-16

DIMENSIONS AND WEIGHT

Wheelbase	1340mm 55"
Seat Height	TBA
Carton Dimentions	1690X460X830mm .40 m3
Plastics/Graphics	BSE150
Weight (n.w/g.w)	110/120kg 243/265lbs
Tank Capacity	6.3 Litres 1.7gallon

TSF 230-X

ENGINE AND TRANSMISSION

Engine	TY230
CC Rating	230cc
Gearbox	Manual 5 speed(N12345)
Starter	Electric Kick
Carburetion	PE28
Exhaust	Pipe Bomb DW1 38mm Exhaust System
Final Drive	520 Chains

SUSPENSION, BRAKES AND WHEELS

Suspension Front	VS1 Adjustable Forks 830mm 53/58.5mm
Suspension Rear	Mono shock Length 450mm
Brakes Front	Hydraulic Disc Brake
Brakes Rear	Hydraulic Disc Brake
Wheel & Tyre Front	80/100-19
Wheel & Tyre Rear	110/90-16

DIMENSIONS AND WEIGHT

Wheelbase	1340mm 55"
Seat Height	880mm 35"
Carton Dimentions	1690X460X830mm .40 m3
Plastics/Graphics	BSE150
Weight (n.w/g.w)	110/120kg 243/265lbs
Tank Capacity	6.3 Litres 1.7gallon

TSF 250-X

ENGINE AND TRANSMISSION

Engine	CB250-F
CC Rating	250cc
Gearbox	Manual 5 speed(N12345)
Starter	Electric Kick
Carburetion	PE28
Exhaust	Pipe Bomb DW1 38mm Exhaust System
Final Drive	520 Chains

SUSPENSION, BRAKES AND WHEELS

Suspension Front	VS1 Adjustable Forks 830mm 53/58.5mm
Suspension Rear	Mono shock Length 450mm
Brakes Front	Hydraulic Disc Brake
Brakes Rear	Hydraulic Disc Brake
Wheel & Tyre Front	80/100-21
Wheel & Tyre Rear	110/90-18

DIMENSIONS AND WEIGHT

Wheelbase	1340mm 55"
Seat Height	880mm 35"
Carton Dimentions	1690X460X830mm .40 m3
Plastics/Graphics	BSE150
Weight (n.w/g.w)	110/120kg 243/265lbs
Tank Capacity	6.3 Litres 1.7gallon

SPARE PART CATALOGUE | TSF150-X, TSF170-X, TSF189-X, TSF230-X and TSF250-X

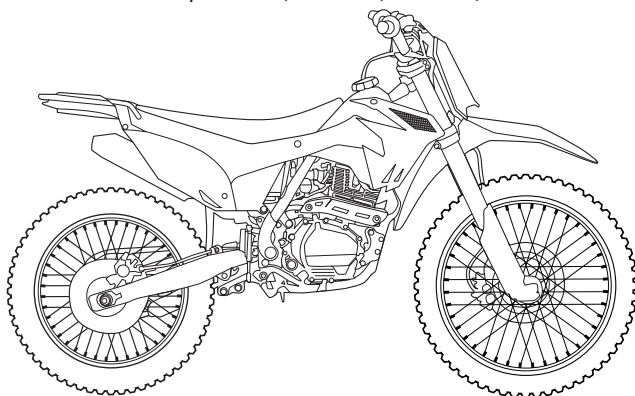
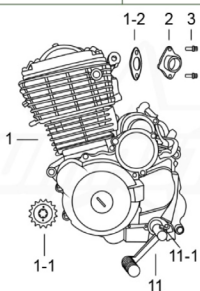
ENGINE TSX230 (Engines & Carburetor)
A - Assembly

POS.	PART NO	ENGLISH NAME	QTY
A	7881	TSF150-X Engine Complete Assembly	1
1		150cc Air Cooled Engine	1
A	7882	TSF170-X Engine Complete Assembly	1
1		170cc Air Cooled Engine	1
A	7883	TSF189-X Engine Complete Assembly	1
1		189cc Air Cooled Engine	1
A	3718	TSF230-X Engine Complete Assembly	1
1		230cc Air Cooled Engine	1
A	7884	TSF250-X Engine Complete Assembly	1
1		250cc Air Cooled Engine	1
1-1		Engine Sprocket 428*151*Φ20	1
1-2		Manifold Gasket	1
2		Manifold	1
3		Bolts M6*16	2
11		Gear shifter	1
11-1		Bolts M6*15	1
	8520	Clutch Assy	1

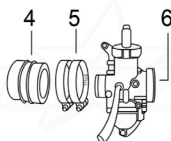
CARBURETOR (Engines & Carburetor)
A - Assembly

POS.	PART NO	ENGLISH NAME	QTY
A	3719	TSX230 Carburetor Complete Assembly	
6	3325	Carburetor PE28-5	1
4	3443	Connector of Carburetor	1
5	3327	Hoops Φ32-44	2

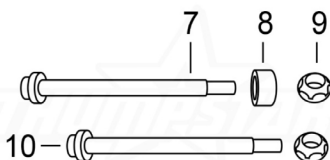
ENGINE'S BOLT (Engines & Carburetor)
A - Assembly

POS.	PART NO	ENGLISH NAME	QTY
A	3720	Engine's Bolt Complete Assembly	
7		Bolts M10*1.25*120	1
8		Spacer Φ10*Φ20*10	1
9		Lock Nuts M10*1.25	2
10		Bolts M10*1.25*115	1

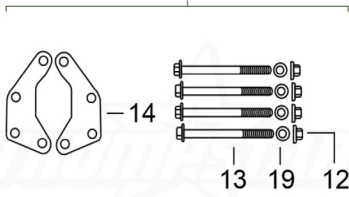
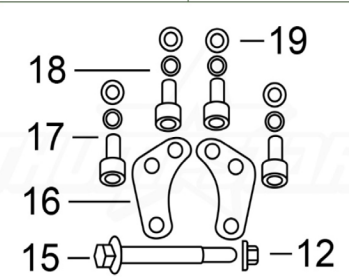
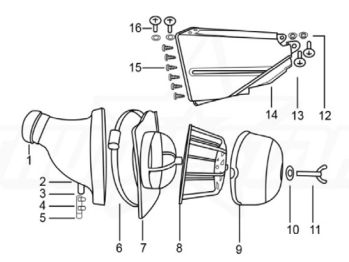
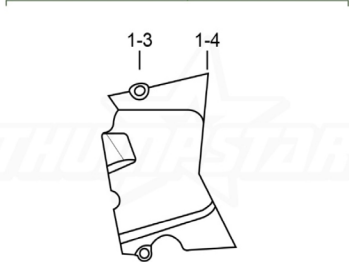
ENGINE'S HANGER A (Engines & Carburetor)		POS.	PART NO	ENGLISH NAME	QTY
<p>A - Assembly</p> 		A	3425	Engine's Hanger A Complete Assembly	
		12		Lock Nuts M8	5
		13		Bolts M8*95	4
		14		Engine Hangers A	2
		19		Washers $\Phi 8 \times \Phi 16$	8
ENGINE'S HANGER B (Engines & Carburetor)		POS.	PART NO	ENGLISH NAME	QTY
<p>A - Assembly</p> 		A	3413	Engine's Hanger B Complete Assembly	
		12		Lock Nuts M8	1
		15		Bolts M8*65	1
		16		Engine Hangers B	1
		17		Bolts M8*16	4
		18		Washers $\Phi 8$	4
		19		Washers $\Phi 8 \times \Phi 16$	8
AIR FILTER (Air Filter & Exhaust)		POS.	PART NO	ENGLISH NAME	QTY
<p>A - Assembly</p> 		A	3721	Air Filter Complete Assembly	
		1		Hoops $\Phi 38 \times 57$	1
		2	3324	Rubber connector	1
		3	3454	Clip	2
		4	3453	Transparent pipe $\Phi 12$	0.02
		5		Cover $\phi 12.5$	1
		6	3328	Hoops $\Phi 140 \times 160$	1
		7	3329	Air Filter Front cover	1
		8	3331	Air Filter bracket	1
		9	3326	Sponge Element	1
		10		Flat Washers $\Phi 8 \times \Phi 22$	1
		11		Screws M6*40	1
		12		Lock Nuts M6	4
		13		Screws M6*25	2
		14	3330	Filter Shield	1
		15		Screws 4.8*16	6
16		Screws M6*16	2		
STATOR COVER (Engines & Carburetor)		POS.	PART NO	ENGLISH NAME	QTY
<p>A - Assembly</p> 		A	3722	Engine Cover Complete Assembly	
		1-3		Bolts M6*30	2
		1-4		Engine Sprocket Cover	1

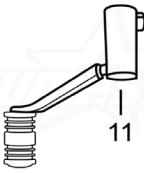
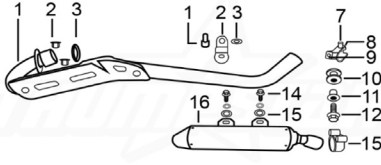
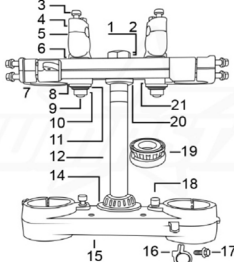
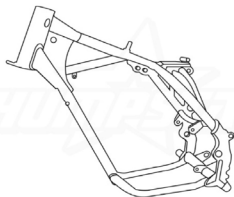
KICK START (Engines & Carburetor)			
POS.	PART NO	ENGLISH NAME	QTY
<p>A - Assembly</p> 			
11	3364	Gear shifter	1
<p>MUFFLER (Air Filter & Exhaust)</p> <p>A - Assembly</p> 			
A	3723	Muffer Complete Assembly	
1	3334	Exhaust Pipe	1
2		Bolts M8	3
3	3335	Seal Ring	1
4		Bolts M8*16	1
5		Fastener	1
6		Washers	3
7		Bolts M6*40	1
8	3428	Hoops Φ32-Φ35	1
9		Nut	1
10	3422	Rubber Cushion	1
11		Spacer Φ6.5*Φ9-Φ20*15	1
12		Screws M6*25	1
13		Hoops Φ40-Φ43	1
14		Bolts M8*20	1
15		Washers Φ8*Φ22	2
16	3333	Muffer 280mm	1
TRIPLE CLAMP SYSTEM			
POS.	PART NO	ENGLISH NAME	QTY
<p>BAR / FORK CLAMPS (Steering)</p> <p>A - Assembly</p> 			
A	3724	Fork Clamps Complete Assembly	
1		Flat Washers Φ23*Φ35	1
2		Nuts M22	1
3		Screws M8*30	4
4	3417	Upper Riser Φ28.8	2
5	3418	Bottom Riser Φ28.8	2
6		Step Washers Φ26*Φ30*3	4
7		Bolts M8*40	8
8	3415	Upper Clamp Φ53*192	1
9		Bolts M12*1.25*72	2
10		Nuts M12*1.25	2
11		Flat Washers Φ12*Φ24*1.5	2
12	3368	Steering Axle 278mm	1
13	3370	Rubber Cover	2
14		Flat Washer Φ26*Φ35*1	1
15	3416	Bottom Clamp Φ58.5*192	1
16	3437	Clip	1
17		Bolts M6*16	1
18		Screws M8*16	2
19	3381	Taper Bearings Φ25*Φ52	2
20		Lock Nuts M25*1*7	1
21		Rubber cushion	4
FRAME SYSTEM			
POS.	PART NO	ENGLISH NAME	QTY
<p>FRAME (Frame)</p> <p>A - Assembly</p> 			
A	3375	Frame	1

FRAME ASSEMBLY PARTS (Frame)		POS.	PART NO	ENGLISH NAME	QTY		
<p>A - Assembly</p>		A	3724	Frame Parts Complete Assembly	1		
		1		Belts 5*168	1		
		3		Nuts M6	2		
		4		Screws M6*12	1		
		5	3414	Brackets	2		
		6	3426	Buckle	1		
		7		M6*16 Hexagon socket head cap screws	1		
		8	3449	Fix Bracket	1		
		9		Nuts M6	2		
		10		Bolts M6*16	2		
		16		Bolts M6*12	1		
		17	3425	Battery Box	1		
FRAME SPARE PARTS							
SUBFRAME (Frame)		POS.	PART NO	ENGLISH NAME	QTY		
<p>A - Assembly</p>		A	3376	Subframe Complete Assembly	1		
		11		Bolts M8*25	2		
		12		Spring washers Φ8	1		
		13		Washers Φ8*Φ16	1		
		14		Lock Nuts M8	2		
		15		Sub-Frame	1		
		18		Screws M8*45	2		
BRAKE PEDAL (Frame)		POS.	PART NO	ENGLISH NAME	QTY		
<p>A - Assembly</p>		A	3725	Brake Pedal Complete Assembly	1		
		12		Lock Nuts M8	3		
		14	3379	Springs	1		
		15	3378	Foot brake pedal	1		
		16	3031	Bearings 608	2		
		17		Washers Φ9*Φ17*2.5	1		
		18		Screws M8*40	1		
		19	3363	Head of brake pedal	1		
		20		Screws M6*16	2		
		21		Nuts M6	1		
		22	3526	Rear Brake limit eccentric	1		
FOOTPEG (Frame)		POS.	PART NO	ENGLISH NAME	QTY		
<p>A - Assembly</p>		A	3726	Pedal Complete Assembly	1		
		1		L.Footpeg	1		
		2	3377	Springs of Footpegs	1set		
		3		Split pin Φ2.5*16	3		
		4		Cylindrical pin Φ8*42	2		
		5		Washers Φ8*Φ16	2		
		6		R.Footpeg	1		
STAND (Frame)		POS.	PART NO	ENGLISH NAME	QTY		
<p>A - Assembly</p>		A	3727	Complete 310mm Stand Assembly	1		
		7	3252	Spring 90mm	1		
		8		Step Bolts M10*25	1		
		9		Washers Φ12*Φ24*1.5	1		
		10	3424	Fix Bracket	1		
		11		Screws M8*30	2		
		12		Lock Nuts M8	3		
		13	3380	Side Stand 310mm	1		

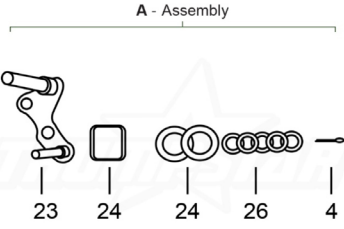
TENSIONER (Suspensions & Swingarm)		POS.	PART NO	ENGLISH NAME	QTY
<p>A - Assembly</p> 					
A	3728			Chain Roller Complete Assembly	
3				Split pin $\Phi 2.5 \times 16$	1
23	3411			Tensioner bracket	1
24	3030			Tensioner	1
25				Bearings 6900	2
26				Washers $\Phi 10 \times \Phi 18 \times 1.5$	5

REAR LINKAGE SYSTEM

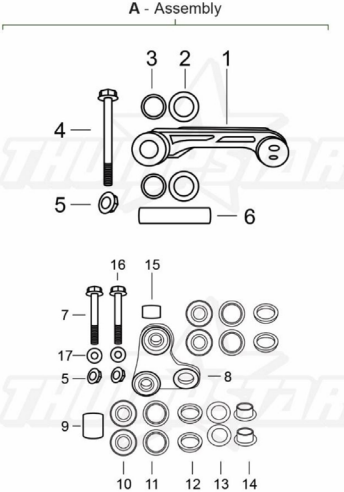
REAR LINKAGE		POS.	PART NO	ENGLISH NAME	QTY
<p>A - Assembly</p> 					
A	3466			Linkage Complete Assembly	1
1	3466			U Linkage A	1
2	3468			Oil Seal $\Phi 20 \times 32 \times 5$	2
3	3474			Needle Bearings HK2012	2
4	3475			Bolts $M12 \times 1.25 \times 118$	1
5	3476			Nuts M12	3
6	3477			Bush $\Phi 20 \times \Phi 12 \times 81 \text{mm}$	1
7	3478			Bolts $M12 \times 1.25 \times 95$	1
8	3469			Triangle linkage B	1
9	3470			Bush $\Phi 18 \times \Phi 12.5 \times 24 \text{mm}$	1
10	3467			Bearings 6001	4
11	3465			Oil Seal $\Phi 20 \times 28 \times 4$	4
12				Bush $\Phi 19 \times \Phi 12 \times 9.5 \text{mm}$	4
13				Bearings 6902	2
14				Step Bush $\Phi 20 \times \Phi 10.2 \times 11 \times \Phi 15 \text{mm}$	2
15				Bush $\Phi 18 \times \Phi 12.5 \times 13.5 \text{mm}$	1
16				Bolts $M12 \times 1.25 \times 83$	1
17				Washer $\Phi 12 \times \Phi 24 \times 1.5$	2

SWINGARM SYSTEM

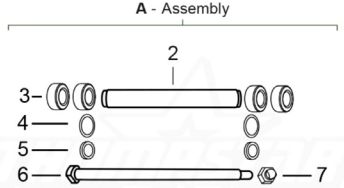
SWINGARM PARTS ASSEMBLY (Suspensions & Swingarm)		POS.	PART NO	ENGLISH NAME	QTY
<p>A - Assembly</p> 					
A	3730			Swingarm Complete Assembly	
2				Inner spacer $\Phi 22 \times \Phi 18 \times 152 \text{mm}$	1
3	3384			Bearing 6002	4
4				Oil seal $\Phi 22 \times 32 \times 7$	2
5				Spacer $\Phi 22 \times \Phi 15 \times 8.5 \text{mm}$	2
6				Swingarm axle $\Phi 15 \times M14 \times 1.5 \times 240$	1
7				Nut $M14 \times 1.5$	1

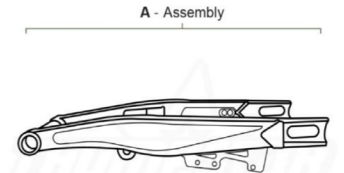
SWINGARM (Suspensions & Swingarm)		POS.	PART NO	ENGLISH NAME	QTY
<p>A - Assembly</p> 					
A	3383			16 inch $\Phi 25$ hole Swingarm Steel	1

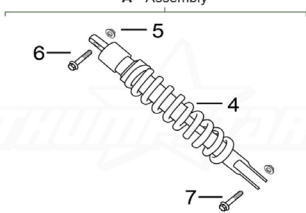
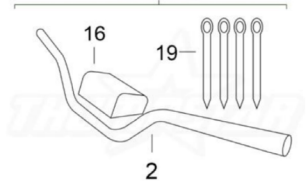
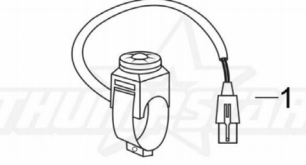
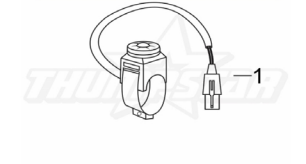
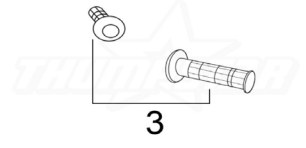
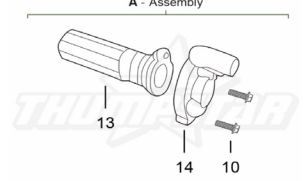
REAR SUSPENSION (Suspensions & Swingarm)		POS.	PART NO	ENGLISH NAME	QTY	
<p>A - Assembly</p> 		A	3390	Rear Suspension Complete Assembly	1	
		4		Rear Shock 450mm*Φ12 adjustment	1	
		5		Lock Nuts M10*1.25	2	
		6		Bolts M10*1.25*60	1	
		7		Bolts M10*1.25*45	1	
OPERATING SYSTEM						
HANDLE BAR (Handle Bar & Hand Controls)		POS.	PART NO	ENGLISH NAME	QTY	
<p>A - Assembly</p> 		A	3734	Handle bar Complete Assembly	1	
		16	3367	Handlebar Pad 72mm	1	
		2	3022	Alloy Fat Bar Φ28.5*22.2	1	
		19	3059	Belts 75mm	4	
KILL SWITCH (Handle Bar & Hand Controls)		POS.	PART NO	ENGLISH NAME	QTY	
		1	3485	Off Switch	1	
ON SWITCH (Handle Bar & Hand Controls)		POS.	PART NO	ENGLISH NAME	QTY	
<p>A - Assembly</p> 		1	3374	Switch ON	1	
GRIP (Handle Bar & Hand Controls)		POS.	PART NO	ENGLISH NAME	QTY	
		3	3323	Grip Complete Assembly	1set	
THROTTLE (Handle Bar & Hand Controls)		POS.	PART NO	ENGLISH NAME	QTY	
<p>A - Assembly</p> 		A		Throttle Complete Assembly		
		14	3350	Cable Tube sleeve	1	
		13	3245	Throttle Perch	1	
		10		Screws		

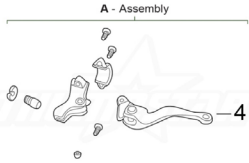
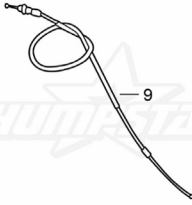
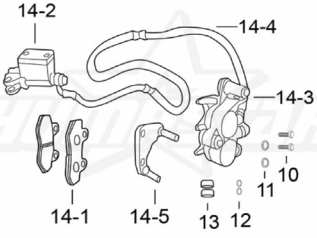
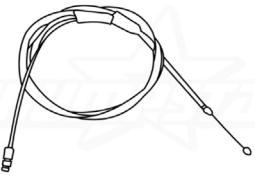
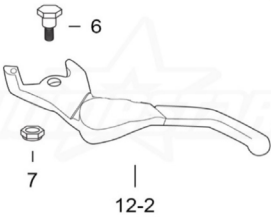
CLUTCH LEVER (Handle Bar & Hand Controls)		POS.	PART NO	ENGLISH NAME	QTY
 <p>A - Assembly</p>		4	3393	Clutch Lever	1
 <p>A - Assembly</p>		9	3372	Throttle Cable M10*1.25	1
FRONT BRAKE SYSTEM					
FRONT BRAKE ASSEMBLY (Handle Bar & Hand Controls)		POS.	PART NO	ENGLISH NAME	QTY
 <p>A - Assembly</p>		A	3391	Front Brake Complete Assembly	1
		10		Bolts M8*40	2
		11		Washers Φ8*Φ16	2
		12		Washers Φ8	2
		13		Spacer Φ8.5*Φ15*5	2
		14	3391	Front Brake Assy	1
		14-1	7408	Brake pads	1
		14-2		Master cylinder	1
		14-3		Bottom pump	1
		14-4		1230mm Front Brake Hose	1
		14-5	3444	Bracket	1
CHOKE CABLE (Handle Bar & Hand Controls)		POS.	PART NO	ENGLISH NAME	QTY
 <p>A - Assembly</p>		A	3419	Choke Cable	1
BRAKE LEVER (Handle Bar & Hand Controls)		POS.	PART NO	ENGLISH NAME	QTY
 <p>A - Assembly</p>		A	3756	Brake lever Complete Assembly	1
		12-2		Brake lever	1
		6		Bolts M8*40	2

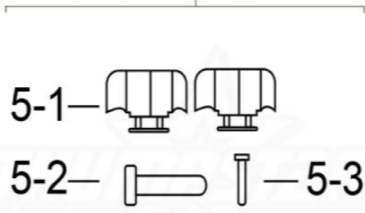

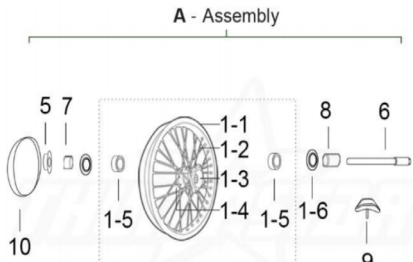

BRAKE PADS (Wheels & Brakes)		POS.	PART NO	ENGLISH NAME	QTY
<p>A - Assembly</p> 		A	3757	Brake Pads Complete Assembly	1
		5-1		Brake pads	1set
		5-2		Clip	1
		5-3		Pin $\Phi 1.5 \times 16$	1

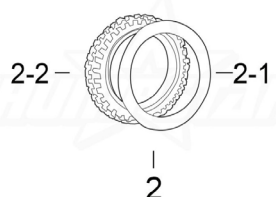
FRONT DRIVING SYSTEM

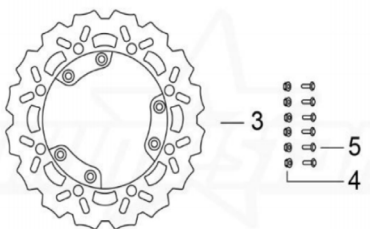
FRONT WHEEL ASSEMBLY (Wheels & Brakes)		POS.	PART NO	ENGLISH NAME	QTY
<p>A - Assembly</p> 		1	7885	Alloy Front Wheel 17"	1
		1	7886	Alloy Front Wheel 19"	1
		1	3396	Alloy Front Wheel 21"	1
		1-1		Alloy Rim 1.6*21	1
		1-2		Nipple 9K	36
		1-3		Hub	1
		1-4		Spokes 250-3 225mm	36
		1-5	6302	Bearings 6302	2
		1-6		Oil seal $\Phi 25 \times 42 \times 7$	2
		6		Front Wheels Axle $\Phi 20 \times 217$ - Step $\Phi 25 \times 44$ mm	1
7		Front Wheel Left Spacer $\Phi 30 \times \Phi 20.2 \times 24 \times \Phi 26$	1		
8		Front Wheel Right Spacer $\Phi 30 \times \Phi 20.2 \times 28 \times \Phi 26$	1		
9		Rim Lock - Alloy	1		
10		21" Rim Belt	1		

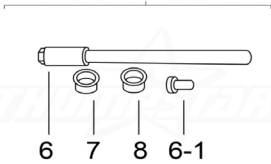
FRONT TYRE ASSEMBLY (Wheels & Brakes)		POS.	PART NO	ENGLISH NAME	QTY
<p>A - Assembly</p> 		A	3759	Front Tyre Complete Assembly	1
		2	7887	Front Knobby tires 80/100-17	1
		2	7888	Front Knobby tires 80/100-19	1
		2	3389	Front Knobby tires 80/100-21	1
		2-1		Inner Tube of front tyre	1
2-2		Front outer tyre	1		

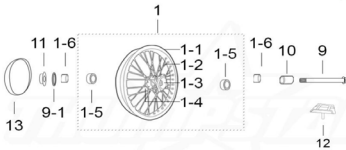
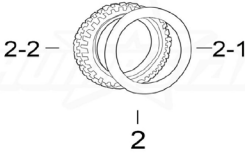
FRONT DISC (Wheels & Brakes)		POS.	PART NO	ENGLISH NAME	QTY
<p>A - Assembly</p> 		A	3394	Front Disc Complete Assembly	1
		3		Front brake disc $\Phi 260 \times 101$	1
		4		Bolts for install plate M6*20	6
		5		Nut M6	6

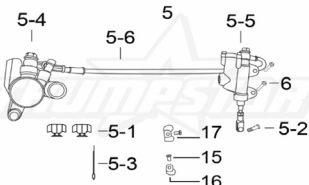
FRONT AXLE ASSEMBLY (Wheels & Brakes)		POS.	PART NO	ENGLISH NAME	QTY
<p>A - Assembly</p> 					
A	3760			Front Axle Complete Assembly	1
6				Φ20*217 Front wheels axle Φ25-44mm	1
6-1				Nut for axle M16*1.5*23	1
7				Front wheel left spacer Φ30*Φ20.2*24-Φ26	1
8				Front wheel right spacer Φ30*Φ20.2*28-Φ26	1
FRONT WHEEL BEARING (Wheels & Brakes)					
<p>1-5</p> 					
1-5	6005			6005 Rear Bearings	2
REAR DRIVING SYSTEM					
REAR WHEEL ASSEMBLY (Wheels & Brakes)		POS.	PART NO	ENGLISH NAME	QTY
<p>A - Assembly</p> 					
A				Rear Wheel Complete Assembly	
1	7889			Alloy Rear Wheel 14"	1
1	7890			Alloy Rear Wheel 16"	1
1	3379			Alloy Rear Wheel 18"	1
1-1				Alloy Rim 2.15*18	1
1-2				Hub	1
1-3				Nipple 9K	32
1-4				Spokes 250-6 176mm	32
1-5	6005			Bearings: 6005	3
1-6				Oil Seal Φ30*47*7	2
9				Φ25*242 Rear wheel axle Φ40-28mm	1
9-1				Nut M24*1.5	1
10				Rear Wheel Axle Left Spacer Φ36*Φ25.2*33-Φ32	1
11				Rear Wheel Axle Right Spacer Φ36*Φ25.2*21-Φ32	1
12	3108			Rim Lock - Alloy	1
13				18" Rim Belt	1
REAR TYRE ASSEMBLY (Wheels & Brakes)					
<p>A - Assembly</p> 					
A				Rear Tyre Complete Assembly	
2	7891			Rear Knobby Tires 100/90-14	1
2	7892			Rear Knobby Tires 100/90-16	1
2	3399			Rear Knobby Tires 100/90-18	1
2-1				Inner Tube of Rear Tires	1
2-2				Rear Outer Tire	1
REAR DISC (Wheels & Brakes)					
<p>A - Assembly</p> 					
A	3395			Rear Disc Complete Assembly	1
3				Front Brake Disc Φ260*101	1
4				Bolts for Install Plate M6*20	6
5				Nut M6	6
REAR BRAKE ASSEMBLY (Wheels & Brakes)					
<p>A - Assembly</p> 					
A	3763			Rear Brake Complete Assembly	1
5	3392			Rear Brake System M6*80	1
5-1				Brake Pads	1set
5-2				Clip	1
5-3				Pin Φ1.5*16	1
5-4				Upper Pump	1
5-5				Bottom Cylinder	1
5-6				Brake Oil Pipe 520mm	1
6				Bolts M6*25	2
15				Bolt M6*12	2
16	3042			Buckle	1
17	3049			Buckle	1

REAR AXLE ASSEMBLY (Wheels & Brakes)		POS.	PART NO	ENGLISH NAME	QTY
<p style="text-align: center;">A - Assembly</p>		A	3764	Rear Axle Complete Assembly	1
		9		Φ25*242 Rear Wheel Axle Φ40-28mm	1
		9-1		Nut M24*1.5	1
		10		Rear Wheel Axle Left Spacer Φ36*Φ25.2*33-Φ32	1
		11		Rear Wheel Axle Right Spacer Φ36*Φ25.2*21-Φ32	1
		15		Flat Washers Φ25*Φ45*3	1
REAR WHEEL BEARING (Wheels & Brakes)		POS.	PART NO	ENGLISH NAME	QTY
		1-5	6005	Rear Bearings 6005	2
CHAIN (Wheels & Brakes)		POS.	PART NO	ENGLISH NAME	QTY
		8	3401	520*106L Chain	1
SPROCKET (Wheels & Brakes)		POS.	PART NO	ENGLISH NAME	QTY
<p style="text-align: center;">A - Assembly</p>		A	3400	Sprocket Complete Assembly	1
		6		Rear sprocket 520*125*143	1
		7		Nut M8	6
		8		Bolt M8*35	6
ELECTRIC PARTS					
CDI (Electrical Parts)		POS.	PART NO	ENGLISH NAME	QTY
<p style="text-align: center;">A - Assembly</p>		A	3404	CDI Complete Assembly	1
		1		CDI	1
		2		Zip Tie	1
RELAY (Electrical Parts)		POS.	PART NO	ENGLISH NAME	QTY
<p style="text-align: center;">A - Assembly</p>		A		Relay Complete Assembly	
		7	3407	12V Relay	1

RECTIFIER (Electrical Parts)	POS.	PART NO	ENGLISH NAME	QTY
A - Assembly 	A	3406	Rectifier Complete Assembly	1
	4		Nut M6	2
	5		Bolt M6*12	2
	6		Rectifier	1
<hr/>				
IGNITION KEY SWITCH (Electrical Parts)	POS.	PART NO	ENGLISH NAME	QTY
A - Assembly 	A	3408	Ignition Key Complete Assembly	1
	5		Electric door lock	1
	11		Keys	2
<hr/>				
BATTERY BOX (Electrical Parts)	POS.	PART NO	ENGLISH NAME	QTY
A - Assembly 	A		Battery Box Complete Assembly	
	6	3409	12V6AH Battery	1
	7	3412	Bandage for battery	1
<hr/>				
IGNITION COIL (Electrical Parts)	POS.	PART NO	ENGLISH NAME	QTY
A - Assembly 	A	3405	Ignition Coil Complete Assembly	1
	2		Ignition coil length 230mm	1
	3		Bolt M6*20	1
<hr/>				
WIRE HARNESS (Electrical Parts)	POS.	PART NO	ENGLISH NAME	QTY
A - Assembly 	A	3410	Wiring Loom Complete Assembly	1
	6		Wire Loom	1
	7		Zip Tie	1

FAIRINGS SYSTEM

PLASTICS ASSEMBLY (Plastics & Fuel Tank)

POS.	PART NO	ENGLISH NAME	QTY
A	3766	Plastic Complete Assembly	1
1		Spacer $\phi 19 \times 8.5 - \phi 6 \times 5.5 \text{mm}$	2
2		Flat washer $\phi 6 \times \phi 18 \times 1.5$	4
3		Bolt M6*16	4
4	3430	Front fender	1
5	3432	Front left side plate	1
6		Nut M6	2
7		Step bushings $\phi 7.4.5 - \phi 9.5 \times 2.5 - \phi 20 \text{mm}$	2
8		Bolt M6*16	8
9		Bolt 4.2*12	4
10	3439	Left middle down side plate	1
11	3430	Left middle up side plate	1
12		Rear left down side plate	1
13		Bolt 4.2*8	3
14	3447	Rear left side plate	1
15	3431	Rear fender	1
16		Flat washer $\phi 6 \times \phi 16$	4
17		Bolt M6*12	4
18		Bolt 4.8*16	2
20	3429	The insulation rubber pad	1
21	3448	Rear right side plate	1
22	3442	Rear right side plate	1
23	3435	Right middle up side plate	1
24	3440	Right middle down side plate	1
25	3433	Front right side plate	1

ENGLISH NAME

QTY

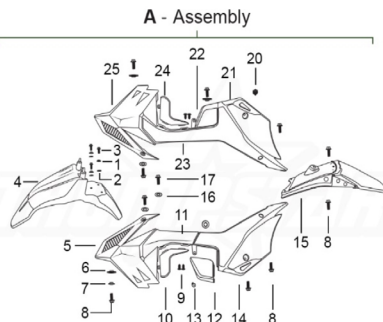

SHOCK GUARD (Plastics & Fuel Tank)

POS.	PART NO	ENGLISH NAME	QTY
A	3438	Shock Guard Complete Assembly	1
18		bolt 4.8*16	2
19		Rear mud	1

ENGLISH NAME

QTY

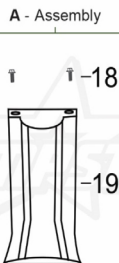

FUEL DELIVERY SYSTEM

TANK ASSEMBLY (Plastics & Fuel Tank)

POS.	PART NO	ENGLISH NAME	QTY
A	3767	Tank Complete Assembly	1
30	3403	Fuel tank	1
31	3427	Plastic fuel cap	1
32		Bolt M6*40	1
33		Spacer for fuel tank $\phi 22 \times \phi 6.5 \times 27 - \phi 12 \text{mm}$	1
34		Flat washer $\phi 10 \times \phi 22 \times 1.5$	1

ENGLISH NAME

QTY

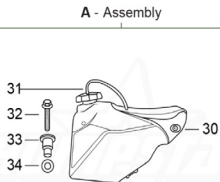

FUEL CAP ASSEMBLY (Plastics & Fuel Tank)

POS.	PART NO	ENGLISH NAME	QTY
A	3052	Fuel Cap Complete Assembly	1
1-2		Fuel pipe 8.2×4.2	1
1		Cap	1
1-1		Seal	1

ENGLISH NAME

QTY

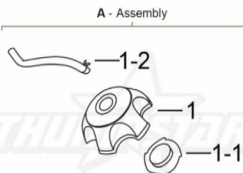

FUEL SWITCH ASSEMBLY (Plastics & Fuel Tank)		POS.	PART NO	ENGLISH NAME	QTY
<p>A - Assembly</p>		A	3769	Fuel Switch Complete Assembly	1
		5		M6*16 Hexagon socket head cap screws	1
		6	3051	ATV Oil tank switch	1
		7		Oil filter	1
		22		M6*10 Hexagon socket head cap screws	2
		23	3062	PH10L Oil tank switch bracket	1
SEAT SYSTEM					
SEAT ASSEMBLY (Plastics & Fuel Tank)		POS.	PART NO	ENGLISH NAME	QTY
<p>A - Assembly</p>		A	3402	Seat Complete Assembly	1
		10		Seat	1
		11		Flat washer $\Phi 8 \times \Phi 22$	1
		12		Nut M8	1
STEERING HEAD BEARING (Steering)		POS.	PART NO	ENGLISH NAME	QTY
<p>A - Assembly</p>		A	3770	Steering Head Bearing Complete Assembly	
		9		Lock Nuts M25*1*7	1
		13	3381	Taper Bearings $\Phi 25 \times \Phi 52$	2
		12	3446	Flat Washers $\Phi 26 \times \Phi 35 \times 1$	1
FORK SEALS (Suspensions & Swingarm)		POS.	PART NO	ENGLISH NAME	QTY
<p>A - Assembly</p>		A	7650	Fork Seals Complete Assembly	4
		1		Fork Seal	2
		2		Dust seal	2
CLUTCH CABLE (Handle Bar & Hand Controls)		POS.	PART NO	ENGLISH NAME	QTY
<p>A - Assembly</p>		8	3373	Clutch Cable 900*145mm Complete Assembly	\$1.00

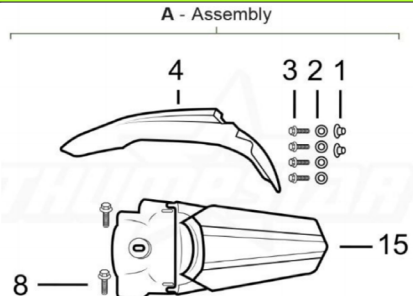
FRONT AND REAR MUD GUARD (Plastics & Fuel Tank)		POS.	PART NO	ENGLISH NAME	QTY
A - Assembly					
					
A	3774			Front and Rear Mud Guard Complete Assembly	
1				Spacer: $\phi 19 \times \phi 8.5 - \phi 6 \times 5.5 \text{mm}$	2
2				Flat washer $\phi 6 \times \phi 18 \times 1.5$	4
3				Bolt M6*16	4
4	3430			Front fender	1
8				Bolt M6*16	4
15				Rear fender	1

HEADLIGHT SYSTEM

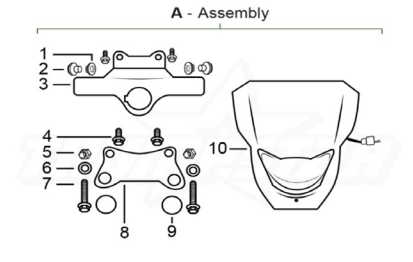
HEADLIGHT ASSEMBLY (Plastics & Fuel Tank)		POS.	PART NO	ENGLISH NAME	QTY
A - Assembly					
					
A	3775			Headlight Complete Assembly	1
1				M6 Nut	2
2				M6*16 Bolt	2
3	3451			Bracket	1
4				M6*12 Bolt	2
5				M6 Nut	2
6				$\phi 6 \times \phi 18 \times 1.5$ Flat washer	2
7				M6*35 Bolt	2
8	3450			Bracket	1
9	3096			CRF110 Plastic stopper	2
10	3445			Front light	1

NUMBER PLATE

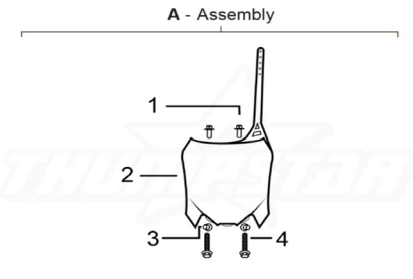
NUMBER PLATE (Plastics & Fuel Tank)		POS.	PART NO	ENGLISH NAME	QTY
A - Assembly					
					
A	3776			Number Plate Complete Assembly	1
1	3451			M6*16 Bolt	
2	3436			Number plate	
3				M6 Nut	
4				M6*35 Bolt	

Generic Torque Settings

USE BLUE MEDIUM STRENGTH THREAD LOCK GLUE



NOTE:

Put glue on tip of the bolt for glue to work correctly.

● ← Places to use Thread Lock Glue

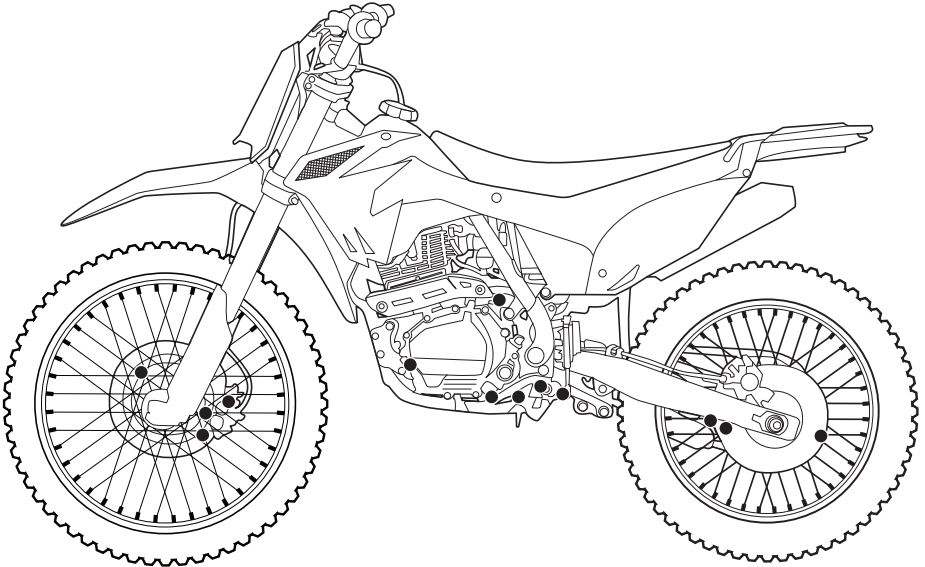

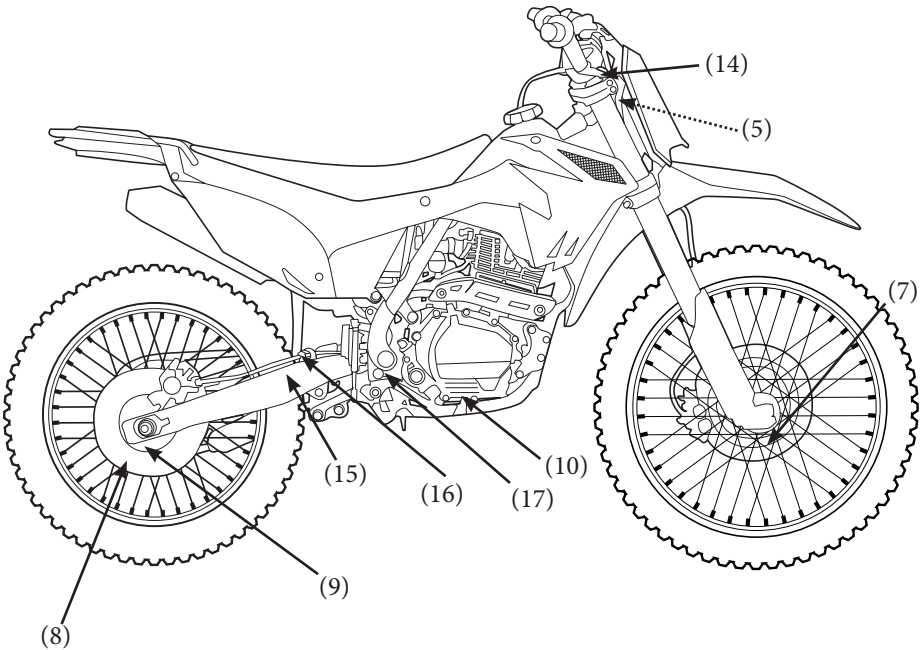
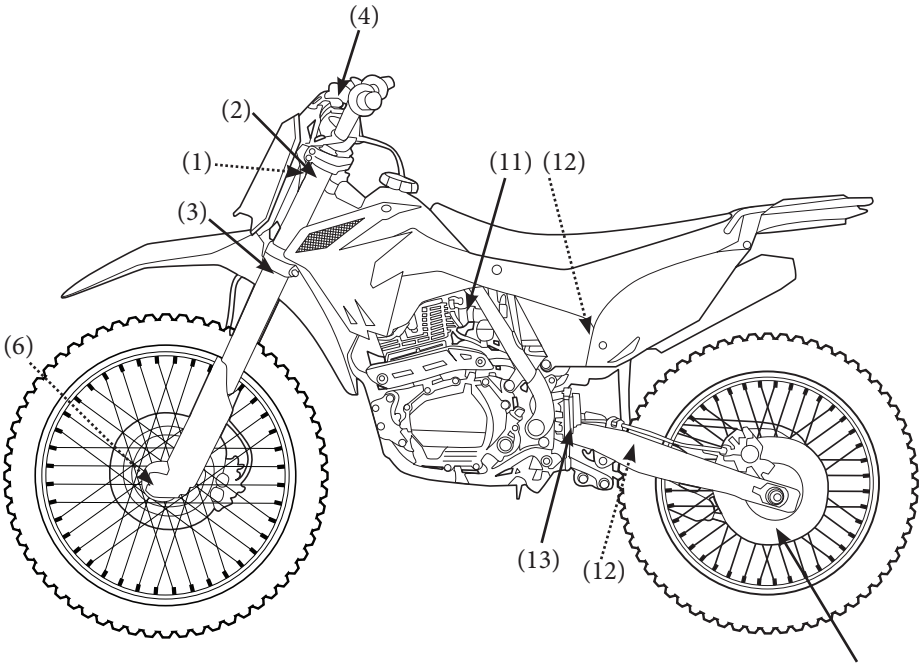

Generic Torque Settings

(Some torque settings may not be correct for this model)

<i>ITEM</i>		<i>TORQUE</i>			
		lb.ft	N.m	kgf.m	
	FRAME				
1	Steering stem nut	64	86.4	8.8	
2	Fork bridge upper pinch bolts	12.8	17.6	1.7	
3	Fork bridge lower pinch bolts	12	16	1.6	
4	Handlebar upper holder bolts	12.8	17.6	1.6	
5	Handlebar holder nuts	25.6	35.2	3.6	
6	Front axle nut	52	70.4	7.2	
7	Front axle pinch bolts	12	16	1.6	
8	Rear axle nut	75.2	102.4	10.4	
9	Chain adjuster lock nuts	16	21.6	2.2	
10	Mid engine hanger bracket nut	37.6	51.2	5.2	
11	Upper engine hanger plate nuts	(engine side)	32	43.2	4.4
		(frame side)	20	27.2	2.8
12	Shock absorber	(upper)	25.6	35.2	3.6
		(lower)	25.6	35.2	3.6
13	Swingarm pivot nut	52	70.4	7.2	
14	Fork	(fork damper)	20	27.2	2.8
		(fork cap)	17.6	24	2.4
15	Rear shock arm nuts	(swingarm side)	31.2	42.4	4.3
		(shock link side)	31.2	42.4	4.3
16	Rear shock link nuts	31.2	42.4	4.3	
17	Kickstarter arm bolt	22.4	30.4	3.1	

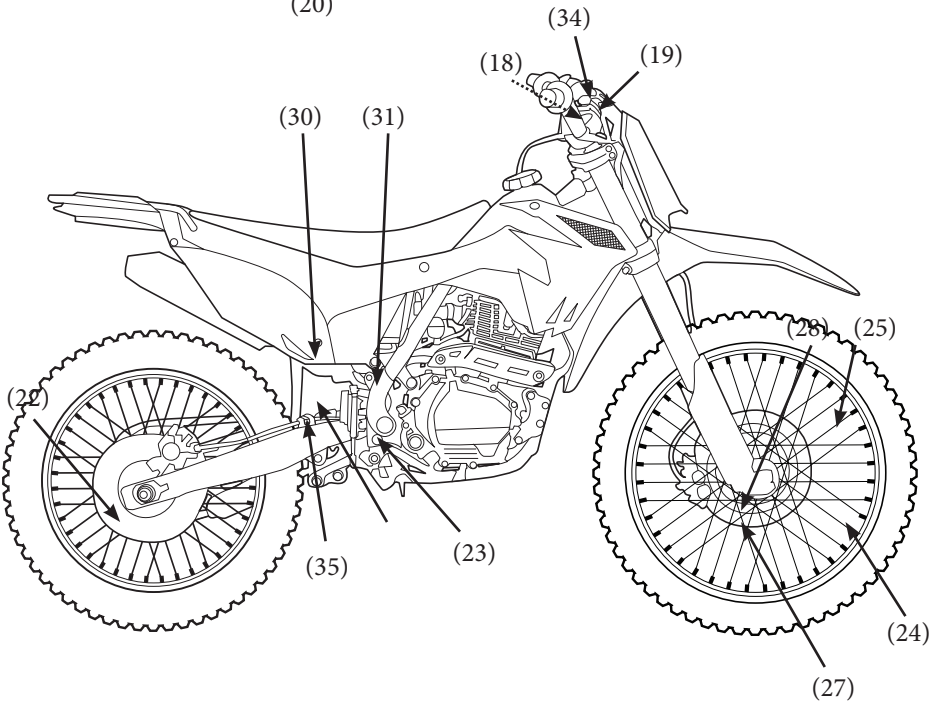
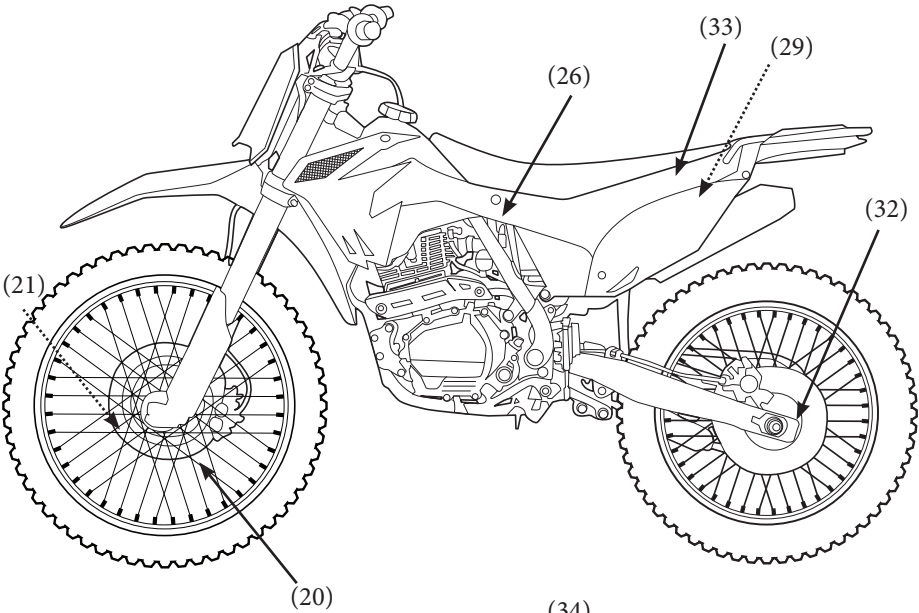

Generic Torque Settings

(Some torque settings may not be correct for this model)

ITEM		TORQUE			
		lb.ft	N.m	kgf.m	
	FRAME				
18	Front brake master cylinder holder bolts		5.6	7.9	0.8
19	Brake hose bolts		20	27.2	2.8
20	Caliper mounting bolts		17.6	24	2.4
21	Front brake disc nuts		9.6	12.8	1.2
22	Rear brake disc nuts		9.6	12.8	1.2
23	Brake pedal pivot bolt		21.6	28.8	2.9
24	Spoke	(front)	2.1	2.9	0.3
		(rear)	2.1	2.9	0.3
25	Rim locks		7.2	9.6	0.9
26	Subframe bolts	(upper)	17.6	24	2.4
		(lower)	28.8	39.2	4
27	Fork center bolt		40.8	55.2	5.6
28	Fork protector bolts		4.1	5.6	0.5
29	Muffler mounting bolts	(right)	15.2	20.8	2.1
		(left)	15.2	20.8	2.1
30	Exhaust joint pipe mounting bolt		15.2	20.8	2.1
31	Exhaust joint pipe clamp bolt		12	16.8	1.6
32	Driven sprocket nuts		19.2	25.6	2.6
33	Seat mounting bolts		15.2	20.8	2.1
34	Front brake reservoir cap screws		0.5	0.8	0.08
35	Rear brake reservoir cap bolts		0.5	0.8	0.08

***Maintenance Tip:**

Use a paint marker reference pen to reference mark each bolt after checking the torque settings.



(Bolt is tight)



(Bolt is loose)



Paint Pen

This will ensure you can visually check each bolt is tight at the track.

Finding Parts at our website

Websites

<https://www.thumpstar.com.au/>

<https://www.thumpstar.co.nz/>

- Go to our website then copy the part number or ERP CODE in our Spare Part Catalogue and paste it in the search bar then press enter or click the search icon beside it.

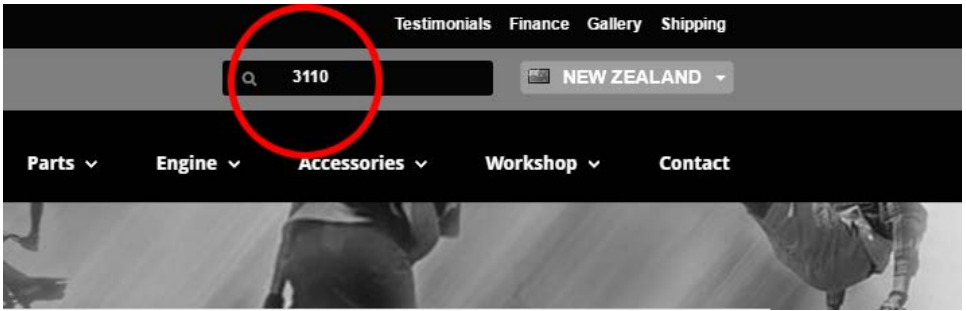

- After searching you will see the parts listed below the search bar

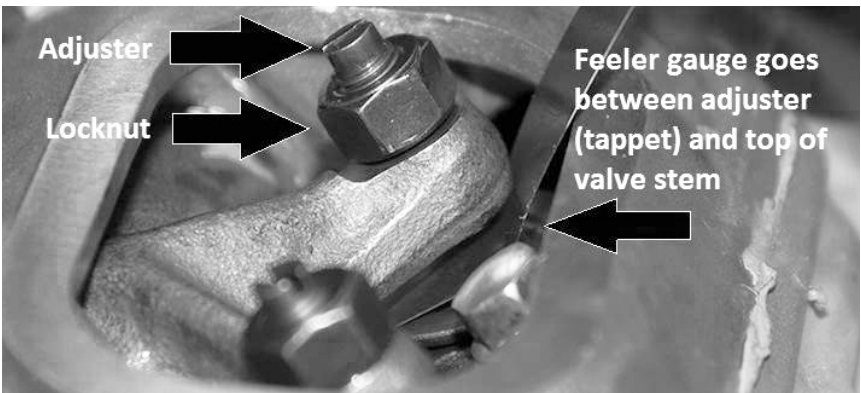

WARRANTY TERMS AND CONDITIONS

The Limited Warranty starts from the date of purchase of the new motorcycle by the customer. Thumpstar will cover PARTS AND FREIGHT ONLY. Thumpstar does not cover the labor required to remove or repair the motorcycle or part for warranty repair or replacement. (Unless otherwise negotiated) In some cases, replacement parts may have to be shipped from overseas and can take up to 8 weeks for delivery.

Purchasing a motorcycle in the crate without setup by a Thumpstar Authorized Dealer void the limited warranty.

Limited Warranty is not transferable and if valid for original purchaser only.

USA: Competition models are absence from a manufactures/limited warranty.

WARRANTY CLAIMS

All warranty claims must be accompanied with the following information and attachments:

- Picture of the motorcycle
- Picture of the problem
- Picture of the VIN number
- Engine faults require a picture of the engine number
- Description of the problem

To file a warranty claim, please visit your local Thumpstar website, which is located in the footer of the website.

Serious risks involved in using any motorised vehicle, including but not limited to: serious physical injury and death. Thumpstar strongly recommends the use of safety equipment while riding. Appropriate safety equipment would include, but is not limited to approved D.O.T or ASNZ 1698 helmet, riding leathers, motorcycle gloves, body armour, knee pads/brace, and riding boots. It's the purchasers responsibility to make sure the instruction manual is followed before use, that this product is assembled by a qualified mechanic and to fully check the motorcycle before every ride for defects or potential defects, if any defects are found then the product should not be used until the defect has been repaired by a qualified mechanic, the purchaser shall use product at their own risk.

Thumpstar will not be held liable under any circumstance for incidental or consequential loss or damage or injury, due direct or indirect use of this product, including any malfunction or defect. This product is not a toy. This product is intended for experienced adult riders on a closed track. Thumpstar makes no claims as to the suitability of this bike for any specific purpose or user. The products in this manual are designed for competition use for a single rider with proper safety equipment. Thumpstar also recommends that any minors only use motorised vehicles under adult supervision and under the guardian's own discretion. Purchasers should check with their local authorities for area specific rules and regulations.

Adult guardian assumes all responsibilities associated with the use of these products by minors. It is not suitable for handicapped persons or persons with limited mental or physical capacities. Although there are no uniform legal age restrictions, Thumpstar recommends that only individuals of legal age use any of the motorised vehicles sold by us. Customers understand that the use of these products can cause injury or death to themselves or others. To reduce the risks of any such injuries we strongly recommend the use of the safety equipment such as an D.O.T, ANSI or Snell approved helmet and knee pads. The Buyer holds our company and its agents and affiliates harmless from any liability arising out of or relating to the use or ownership of any product. Buyer must obtain her/his own insurance. Purchaser fully accepts responsibility & releases the seller for all & any personal injuries, fatal injuries, any losses, costs, and damages incurred

as a result of Purchaser's operation of this item. Purchaser is solely responsible when permitting other riders to ride this item, and assumes all responsibility in event of damages, injuries or fatal injuries etc. Purchaser is responsible for understanding and obeying all local and state laws for operation of this product. Once purchaser submits payment this will serve as purchaser agreement to releasing seller of any and all responsibilities of item such as stated above. Before riding check your local states/cities motorcycle codes for more information regarding laws. This product is for use on closed private tracks only.

By purchasing, you acknowledge that you have read and understood, and you agree, to the terms and conditions of this Agreement, and you represent that you are of legal age (age 18 or older) to enter this Agreement and become bound by its term.

While all care is taken, any errors and omissions in the item details are unintentional. Therefore, Thumpstar cannot be held liable for any errors or omissions on these adverts.

SERVICE MANUAL

NAME OF SERVICE PERSON	DATE OF SERVICE	HOURS OF SERVICE	SIGNATURE

*For more information on service go on page 37.

NAME	BUYER SIGNATURE	SELLER SIGNATURE	DATE OF PURCHASE

