

EMMO

GREEN YOUR LIFE

# USER'S MANUAL



EMMO  
Utron

# CAUTIONS

This manual contains important safety, performance, and service information. Read and understand it along with the information provided during the on-delivery instructions before using the product, and keep this manual for future reference.

© 2019 EMMO Inc. All rights reserved. No texts, details, or illustrations from this Manual may be reproduced or distributed, or become the subject of unauthorized use for commercial purposes. Should you discover any errors, we would be grateful if you would bring them to our attention.

# MENU

About EMMO.....	4
Rules And Regulations.....	5
Speedometer And Controls .....	6
Rear Shock .....	15
Thumb Throttle.....	16
Safety Instructions.....	17
How To Ride.....	18
How To Charge.....	19
Maintenance Information.....	21
E-Bike Registration Form.....	22

# ABOUT EMMO

*Established in 2009, EMMO Inc. is a proud Canadian venture that is focused on creating a more sustainable future by providing high-quality electric bicycles. We offer a wide variety of E-bikes that are suitable for leading a greener, and more stylish, way of living. EMMO E-bikes are priced competitively with other green solutions. At EMMO, you will get the best e-bikes and also receive the best service.*



GREEN YOUR LIFE

# RULES AND REGULATIONS

## Of riding an e-bike

According to Canada's Motor Vehicle Safety Regulations (MVSR). A qualified e-bike (defined as Power Assist Bicycle) must meet the following requirements:

- ***The e-bike must have operable pedals***
- ***Upper wattage limit for the motor is 500W.***

Other requirements include a permanently affixed compliance label from the manufacturer stating that the vehicle is a power-assisted bicycle under statutory requirements in force at the time of manufacture. Currently, there is no license, no insurance, and no vehicle registration required to operate a qualified e-bike according to federal legislation. E-Bike riders share the same rights and responsibilities as other road users.

However, provinces and local municipalities have the power to restrict the use of e-bikes. Most provinces require the rider to wear a helmet. Some provinces have special requirements concerning the age limit to operate an e-bike, the type of helmet required, and even the number of wheels and wheel size. In Ontario, typically, e- be-bikes are generally treated the same as regular bicycles. According to the Ministry of Transportation of Ontario (MTO), the age limit to operate an e-bike is 16 years old and above; the maximum weight of the bike is 120 kilograms (265 pounds); the bike must have a brake distance of fewer than 9 meters; Any modifications made to the bike's motor to create speeds greater than the legal speed limit are prohibited.

As the rules and regulations are subject to changes in different provinces and municipalities. Please check your municipal bylaw and see where you stand.

# 1. Speedometer and Controls

## 1.1 Product appearance



## 1.2 Functions

- Multiple Power Assist Levels
- Walk Assist (slow speed motor assist)
- Distance and Odometer (TRIP/TOTAL)
- Backlight / Headlight
- Current riding speed in real time
- Error codes
- Power meter (Watts or Amps)
- Battery Gauge (Voltage or Percentage)

**Note:** Voltage is recommended for a more accurate battery capacity estimation

USB charging port 5V at 0.5A

## 1.3 Button definition



## 1.4 Product specifications



- Maximum operating current: 30mA
- When power is off, leak current is less than 1uA
- Operating current supplied to the controller: 50mA
- Operation temperature: -4°F~113°F
- Storage temperature: -22°F~158°F
- Storage humidity: 30%-70%
- Water Resist level: IP65

# CAUTION

Avoid collisions to prevent damage or malfunction.

The unit is IP65 water resistant.

Bolt Size: M3 0.5 x 12mm (Control pad and Mount bracket)

## 1.5 Interface

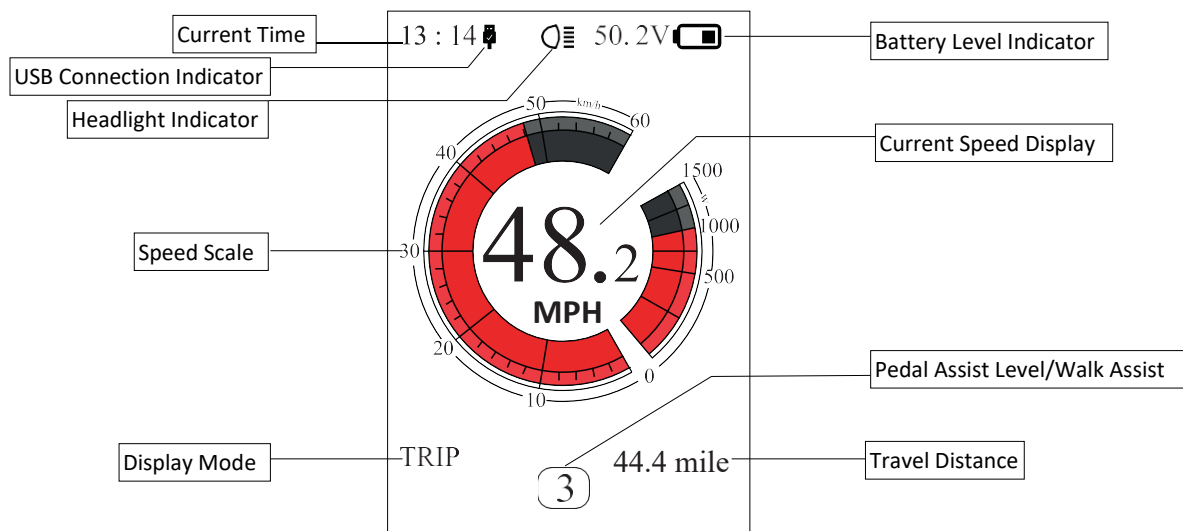

### Current Time:

The current time in 24-hour clock. Go to the “Set Clock” option in the display setting to set or change the time.

### USB Connection Indicator:

The symbol is displayed on the screen when an external device is connected.

### Headlight Indicator:

The symbol is displayed on the screen when the backlight/headlight is on.

### Speed Scale:

The speed scale will show both speed and motor power information.

### Display Mode:

This displays the current mode selected. The display mode includes single-trip distance (TRIP), total distance (ODO), maximum speed (MAX), average speed (AVG), and travel time (TIME).



### **Battery Level Indicator:**

The indicator shows the current battery level.

The indicator can show battery level value in percentage or voltage. You can set this display option in the “SOC View” of the display settings menu.

### **Current Speed Display:**

This displays the current travel speed in metric or imperial. Set your preferred unit in the “Unit” option of the display setting menu.

### **Pedal Assist Level/Walk Assist:**

This displays the level of the pedal-assist function. It also displays the walk assist symbol when the walk assist mode is engaged.

### **Travel Distance:**

Display the distance accumulated under the selected mode.

## **1.6 Functions**

### **On/off:**

To turn the unit on, press and hold the power button to start the display. Press and hold the power button again to switch it off.

Note: The battery must also be turned on (if applicable)

If the password function of the display is activated, you will need to input the correct password to enter the normal user display interface.

### **Display Information:**

Press the  button to cycle through the current information data available on the main menu of the display. The information is displayed on the bottom of the screen and includes the single-trip distance (TRIP), total distance (ODO), maximum speed (MAX), average speed (AVG), and riding time (TIME).

### **Pedal Assist Level:**

The display unit is integrated with the control pad to provide several levels of power. Press the “+” or “-” button to increase or decrease the power and speed levels.

### **Walk Assist Mode:**

Press and hold the “-” button to activate walking assist mode. The walking icon will be displayed on the screen and the motor will move the bicycle at about 4 mph (6.4 km/h).

To turn off the walk assist, let go of the button.

The function is designed for walking alongside the bicycle only. Please do not use this function when riding.

When the display is powered ON the default is PAS level 0.

Note: Increasing your PAS level provides more power and speed.

### **Backlight Display:**

Press and hold the light button  for a few seconds to dim the display backlight of the device. This will change the backlight to a darker setting for night riding.

Press and hold the light button  again to turn off this feature and return to the default backlight setting.



If a front light is installed, this will also power the light

## **1.7 DISPLAY SETTINGS**

### **Preparation:**

Make sure the display is turned ON.



### **To Enter Setting:**

Press the  button twice quickly and press the  button again when “Display Settings” is selected to enter the Display Settings. This will enable you to adjust the default settings of the device to your preference.

### **Controls:**

Press the  button to select and use the “+” and “-” buttons to toggle between the options.

### **Unit:**

This displays the unit of the speed in Metric (km/h) or Imperial (mph). Press the  button once to save your preferred setting and exit this option. Use the  button to scroll down to the next display setting option.

### **Brightness:**

Use this setting to adjust the default brightness of your device. You may adjust this setting to pre-set values between 10%, which is the lowest available brightness, and 100% which is the highest available brightness.

### **Auto-Off:**

This sets the time in minutes that the display system is inactive before turning off.

### **Max PAS:**

This sets the number of pedal assist levels for your motor. You can adjust this level to

divisions of 3, 5, or 9 levels of the total motor power.

Note: The number of pedal assist levels (3, 5, or 9) you set in your display divides the total power of the motor among the number of pedal assist levels.

\* We highly recommend setting your display to 9 Pedal Assist Levels to have access to more incremental power levels.

### **Power View:**

This allows you to select your viewing preference for the power of the motor. This may either be in Watts or in Current (Amps).

### **SOC View:**

This sets how the battery power level is displayed on the screen. The sign can either be in percentage or in voltage. We recommend using voltage, as this provides a more accurate gauge of the battery charge level.

### **TRIP Reset:**

This allows you to reset the TRIP readings of the odometer on your display. It is a one-time setting and once cleared, your TRIP readings will go back to reading zero.



This reset includes maximum speed (MAXS), average speed (AVG), and single trip distance (TRIP).

### **Wheel Size:**

This sets the wheel diameter size in inches and should be done before riding your bike. Please input the correct tire size into the display to enable accurate measurement of speed and other ride information.

Available Wheel Sizes are: between 6" to 34"





### **Speed Limit:**

Press the  button to select this option and adjust the speed limit to your preference. Press the  button again to save your setting and exit this option. Use the  button to scroll down to the next display setting.

Note: Check your local laws regarding e-bike speeds. Setting the speed above the legal limit is not advised. This function may not be available on some models.

### **AL Sensitivity:**

This is used to adjust the back-light dim setting in low light conditions. It will set the light sensitivity of your device.

Press the  button to enter this option and adjust the setting to your preference by using the  and  buttons. Use the  button to increase the value to the highest (Level 5) and press the  button to reduce it to the lowest value (Level 1). Press it one more time at the lowest value to turn off this setting.

## Clock Setting:

The clock in this display uses 24-hour notation. Please note that the clock will reset every time you remove the battery of the device.

To set the clock, press the **i** button on the option and use the **+** and **-** buttons to adjust each value.

The cursor will appear on the first input digit of the hour section, adjust this input using the **+** and **-** buttons. Press the **i** button to confirm the selection and switch to the second input digit. Adjust this as well, using the **+** and **-** buttons. Confirm your selection and switch to the minute by pressing the **i** button.

Repeat this for the remaining input digit of the clock and press the **i** button to save the setting and exit this option.

Use the **-** button to scroll down to the “Back” option and select it by pressing the **i** button to exit the display setting menu.

## 1.8 Password

This option is used to lock the display device and prevent unauthorized access. If activated, a 4-digit input password will be required to enter the normal user interface when the device is turned on.

### 1.8.1 Setting Password

Cycle through the password option using the **-** button and select “ON”. The display will show an interface to input your preferred password.

Scroll and Select between numbers “0–9” using the **+** and **-** buttons for each entry slot. Press the **i** button to confirm your selection for each slot. Press the **i** button again to confirm the inputted password.

You will need to enter the password a second time, repeat the above step and input the same password. If the password is the same as the previous entry, the system will display a prompt showing that you have successfully set your password. With an incorrect entry, you will need to repeat the first step and input the password and reconfirm.

After correctly inputting the password, the interface will automatically exit to the password menu.

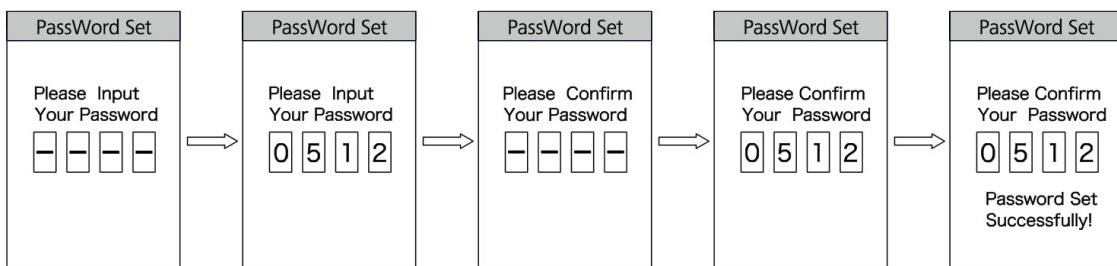

## 1.8.2 Changing Password

Once the password is set, the option “Reset Password” will appear in the password menu.

Select “Reset Password” from the menu, the interface will display a prompt you to input the current password to access this option. Please input the correct current password.

Inputting the wrong password 10 times will cause the display system to switch off automatically.

If the password is correct, the interface will display a prompt to input the new password. Repeat the process of “Setting Password” reconfirming the password as described above. The interface will automatically return to the password menu at the end of this action.

Select the back  button to exit this menu

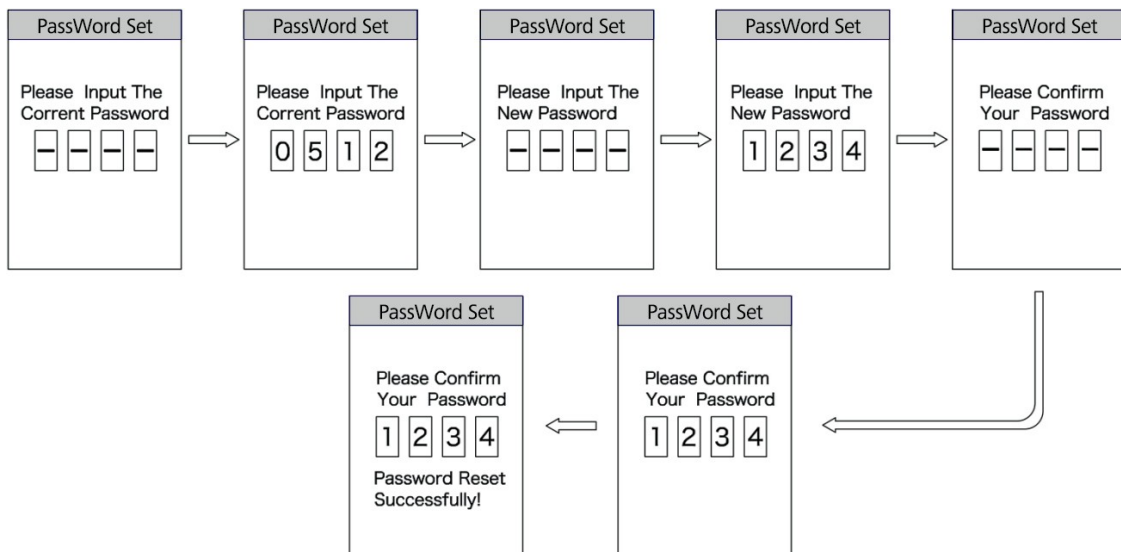

## 1.8.3 Disable password

To disable the password option, enter the start password interface and select the “OFF” option. The interface will display a prompt to input the current password to disable the password option. After correctly entering the current password, the interface will display a prompt showing you have successfully disabled the password. It will exit back to the password menu automatically.

If you enter the incorrect password 10 times, the display will turn off automatically.

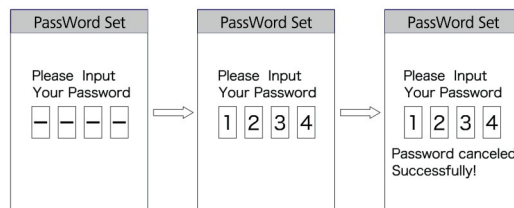

## 1.9 Error Codes

Once the display detected a fault, the icon  will be displayed. Error Codes can be found under Information → Error Code

Error Code	Code Definition
04/05	Throttle Fault
06	Low Voltage Cut-Off Protection
07	High Voltage Cut-Off Protection
08	Hall Sensor Fault
10/11	Over Heat Cut-Off Protection
12	Controller Fault
21	Speed Sensor Fault
22	Battery Communication Error
30	Communication Error

## 2. Rear Shock

### A5RR1 and A5RE

To set the pressure in the main cylinder (valve marked "MP"), use a compatible shock pump. Remove the valve cap and attach the shock pump according to the pump manufacturer's specifications.

**Recommended air pressure for the main cylinder is 100-150psi.  
DO NOT EXCEED 180psi.**

### A5RR1 ONLY

The A5RR1 uses an additional adjustment feature indicated by the air valve positioned at the smaller end of the shock. To set the negative pressure (valve marked "NP"),

**THE NEGATIVE PRESSURE MUST NOT EXCEED THE MAIN PRESSURE.**

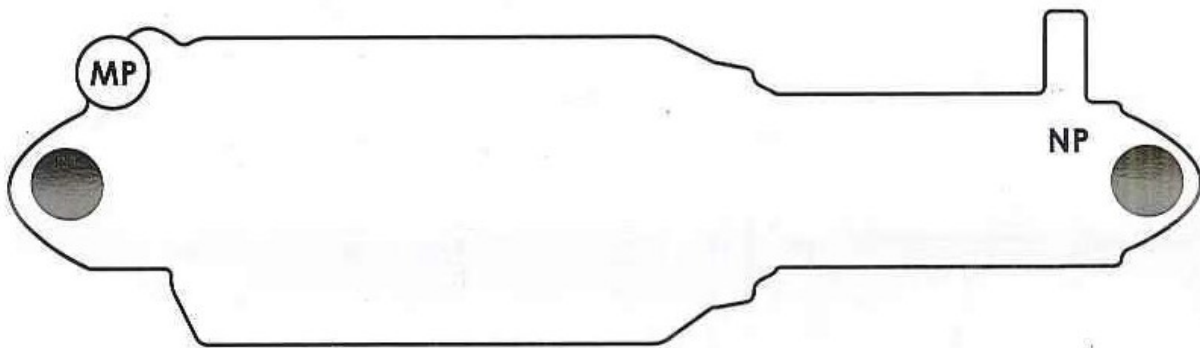

Lubrication: It is recommended that the main shaft be lubricated every 25-30 hours of use or after a long period of non-use.

Cleaning: Use only warm water and a lint-free soft cloth to wipe down. Do NOT use solvents, degreasers, waxes and other chemicals, as they may damage the shock and void the warranty.

### **WARNING**

Your ExaForm Rear Shock requires regular maintenance to function. ExaForm Rear Shocks must be regularly maintained by an authorized ExaForm Service Center. Service center locations can be found at [www.kindshock.com.cn](http://www.kindshock.com.cn).

Do not disassemble your rear shock. Disassembly could cause damage and severe personally injury as some of the contents are under pressure. Failure to follow these warnings and instructions will immediately void your warranty.

### 3. THUMB THROTTLE



Gently pushing the throttle lever downwards to accelerate.



# 4. SAFETY INSTRUCTIONS

## To ensure the safety of you and others,

- Do not ride after you take medications which may affect your riding ability, drink alcohol, or when you are unwell.
- Please make sure you are familiar with your local bylaw regarding e-bikes.
- Check the road conditions and weather conditions, so as to actively avoid danger.
- Wear necessary protective equipment, such as a helmet, if required by local bylaw.
- Perform a basic inspection of the bike before the ride:

**1. Battery strength:** make sure that you have enough charge for the trip.

**2. Tire pressure:** on the casing side of the tire you will find the minimum and maximum pressure that applies to the tire. Insufficient tire pressure will affect the performance of your bike.

**3. Brakes:** check and make sure both brakes are in good working condition.

**4. Lights/signals:** make sure that headlight, signal lights, tail light and brake light are working well. Make sure you have a working rear reflector/ tail light if you need to ride the bike at night.

# 5. HOW TO RIDE THE BIKE

- Sit on the bike. Put on the helmet or any protective equipment required.

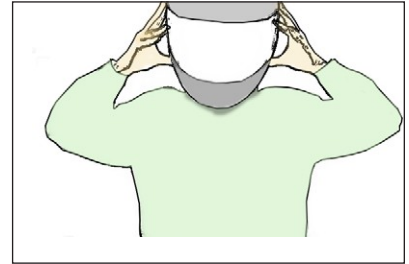

- With your feet still on the floor, turn the bike on (refer to page 10).

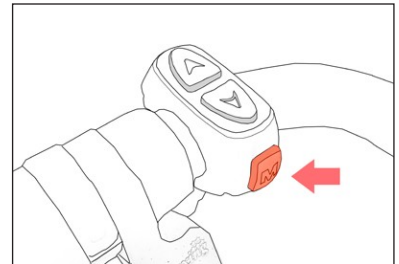

- Before you start off, kick the side kickstand up.

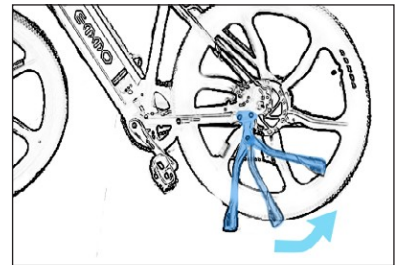

- When you are ready, start pedaling or turn the throttle. (NB: You don't have to pedal to start the bike.)



## 6. HOW TO CHARGE



The charger is separated into two different parts:

1. A cable with one end that goes into an 110V power outlet, and the other end that goes into the charger box itself.

2. The charger box with a cable that plugs into the bike.

3. The charger box with a cable that plugs into the bike.

**Step 1.** Take the cable from the charger box and plug it into the charging port on the battery.

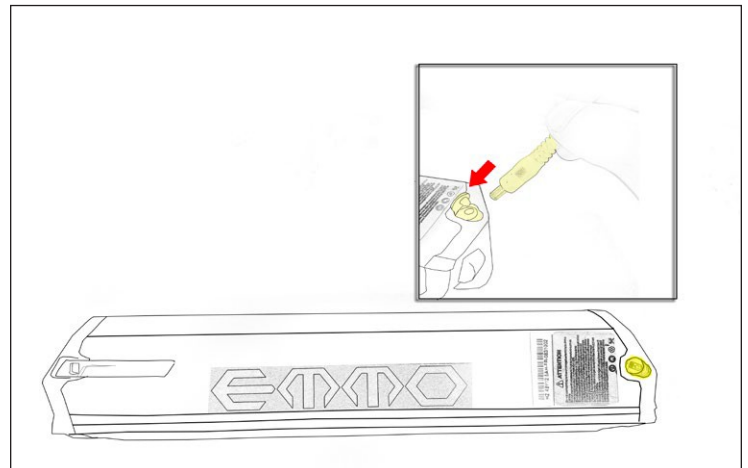

**Step 2.** Plug the charger into a regular 110V outlet.

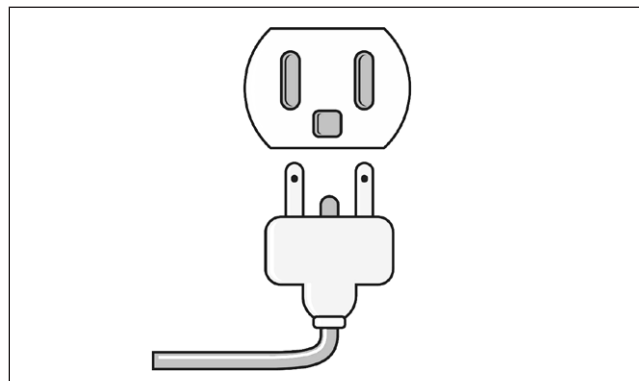

**Step 3.** Make sure the indicator on the charger turns red (red indicator means it charging, green indicator means the battery is fully charged.)

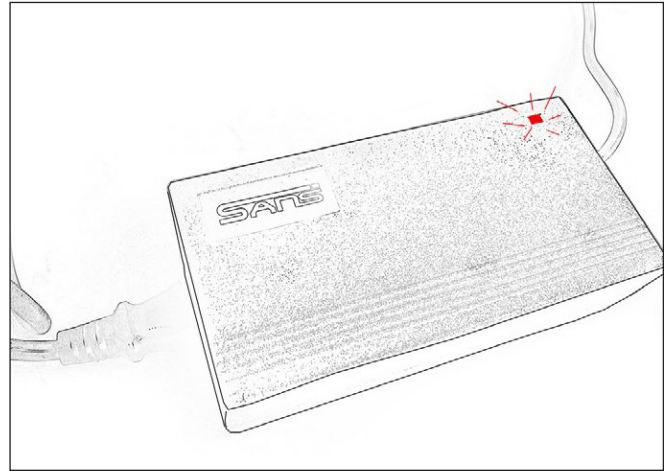

is

**Step 4.** Once the battery is fully charged, unplug the charger from the power outlet first and then unplug the charger from the battery.

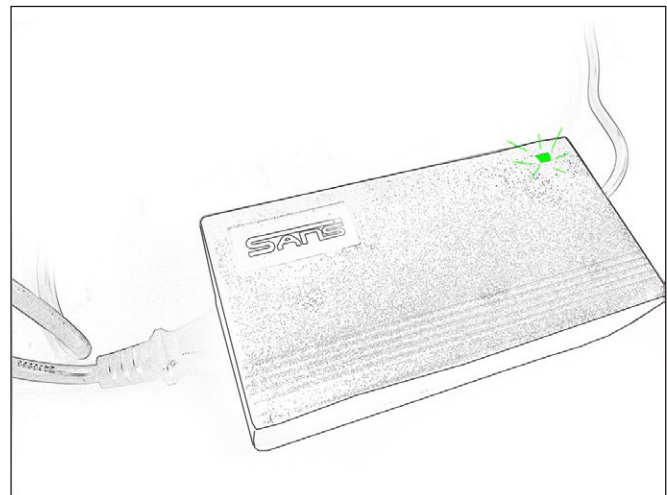

***Warning: Do not charge the battery for more than 8 hours. If you have any concern, please contact your local dealer for assistance.***

# 7. MAINTENANCE

*Regular maintenance is required to keep the bike in its best working conditions.*

## CLEAN

Please use clean water and neutral detergent to clean the bike. Use soft cloths or sponges to clean the surfaces. Please do not use metal brushes, sandpaper or any other abrasive material to avoid scratches or physical damage. Dry the bike with soft cloths. Please clean and grease the chain and sprockets.

### *Warning:*

- **Please turn off the circuit breaker and remove the battery (if applicable) before cleaning the bike.**
- *Please do not power wash the e-bike.*

## STORAGE

In case of storage for more than one month, such as winter storage, **Please charge the battery regularly (at least once a month) and turn off the circuit breaker.** The bike, including the battery and charger, is suggested to be stored in a clean, dry ventilated place. Please do not leave the battery outside under freezing temperature. Please avoid any corrosive material or heat source.

## REGULAR INSPECTION

For **every 3000km** you travel or every **6 months**, a full inspection/tune-up is recommended based on the condition of the bike

# E-Bike Registration

Once you have purchased an Emmo E-bike, you can register your vehicle with us to validate your warranty.

In order to register your e-bikes, please follow the steps listed below:

1. Fill out the following form:

Invoice Number: \_\_\_\_\_

Store Location: \_\_\_\_\_

Customer Name: \_\_\_\_\_

Address: \_\_\_\_\_

Phone Number: \_\_\_\_\_

E-mail: \_\_\_\_\_

Survey:

How did you find out about Emmo Inc.? (Please select the options that apply)

Returning Customer     Family/Friend     Passing by Store     Kijiji  
 TERA     Google     Yelp     Other \_\_\_\_\_

2. Send the information listed above to our e-mail: [info@emmo.ca](mailto:info@emmo.ca)

3. Wait for a confirmation e-mail from Emmo Inc.