



Manuel du Propriétaire - Owner's Manual

TOME 1

POUR TOUS LES MODELES - FOR ALL BOAT MODELS

Z NAUTIC met à votre disposition les manuels propriétaires en format digital pour les langues Français / Anglais / Italien / Allemand / Espagnol et Norvégien. Pour toutes autres langues se rapprocher de votre distributeur pour demander aux équipes de Z NAUTIC en bon et due forme.

Z NAUTIC puts at your disposal the owner's manuals in digital format for the French / English / Italian / German / Spanish and Norwegian languages. For all other languages, contact your distributor for request to the Z NAUTIC teams in due form.

Register your boat today on the Zodiac Club

<https://www.zodiac-nautic.com/fr/zodiac-club/>



Get a Warranty extension of
3 YEARS
for your new boat*



FR

Enregistrez votre bateau dès aujourd'hui sur le "Zodiac Club"
<https://www.zodiac-nautic.com/fr/zodiac-club/>. Bénéficiez d'une extension de 3 ans de Garantie constructeur pour l'achat d'un bateau neuf*
*voir conditions générales de la garantie Zodiac Nautic

IT

Registri il suo battello oggi sul "Zodiac Club"
<https://www.zodiac-nautic.com/fr/zodiac-club/>. Beneficierà dell'estensione di 3 annos di Garanzia costruttore sull'acquisto di un battello nuovo*
*vedere le condizioni generali della garanzia Zodiac Nautic

ES

Registre su embarcación ahora en el "Zodiac Club"
<https://www.zodiac-nautic.com/fr/zodiac-club/>. Beneficiese de una extensión de garantía de tres años, en la compra de una embarcación nueva*
*ver las condiciones generales de la garantía Zodiac Nautic

DE

Registrieren Sie Ihr Boot heute im "Zodiac Club"
<https://www.zodiac-nautic.com/fr/zodiac-club/>. Erhalten Sie die 3-jährige Garantieerweiterung für Ihr neues Boot.*
*Siehe Zodiac Nautic Garantiebedingungen

Manuel du Propriétaire

Tome 1

GENERALITES-PRECAUTIONS-SECURITE

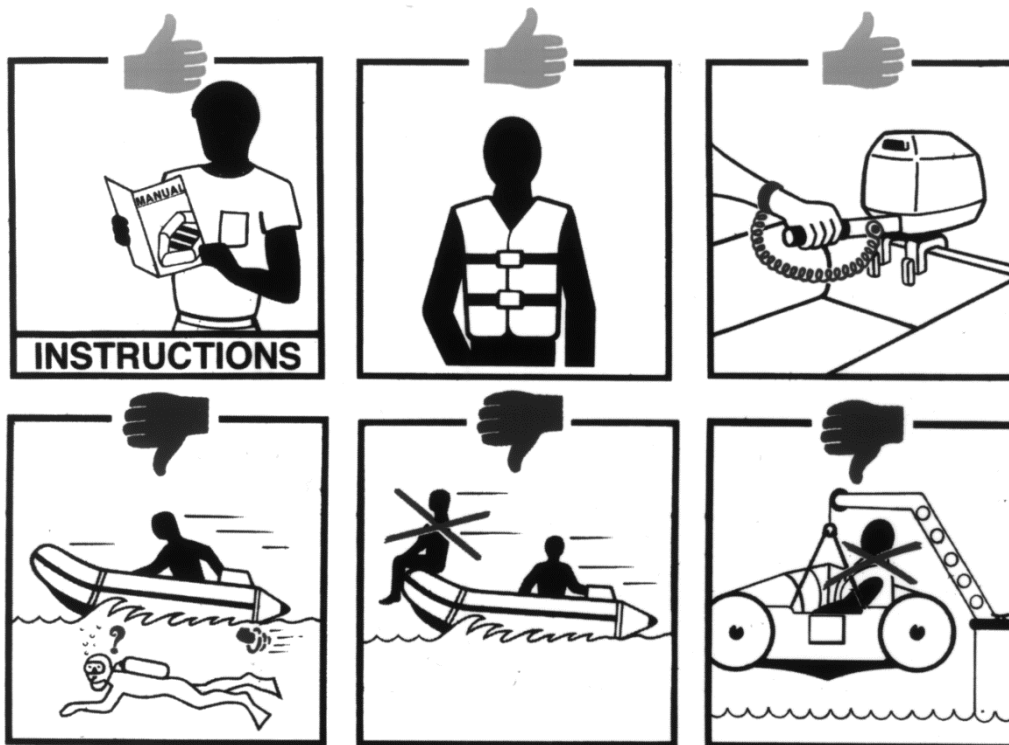

AVERTISSEMENT

- LISEZ ATTENTIVEMENT CE MANUEL AVANT MISE EN SERVICE DE VOTRE BATEAU
- LE MANUEL DU PROPRIETAIRE SE DIVISE EN DEUX TOMES

611957 - A

<p>NOTE :</p>	<p>Le manuel du propriétaire se divise en deux tomes :</p> <p>Le tome 1</p> <p>Traite d'une manière générale des précautions d'usage et des recommandations à respecter à bord du bateau et sur l'eau.</p> <p>Le tome 2</p> <p>Traite plus particulièrement des caractéristiques techniques et du montage du bateau et de son équipement.</p>
----------------------	--------------------------------------------------------------------------------------------------------------------------------------------------------------------------------------------------------------------------------------------------------------------------------------------------------------------------------------------------------------------

	<p>Naviguer est un plaisir, et nous voulons que vous en profitiez durant de longues années.</p> <p>Prenez le temps de lire attentivement ce manuel du propriétaire afin d'assimiler les conseils de navigation et les mesures de sécurité qu'il contient.</p> <p>Et n'oubliez pas : la sécurité avant tout !</p>
-------------------------------------------------------------------------------------	---------------------------------------------------------------------------------------------------------------------------------------------------------------------------------------------------------------------------------------------------------------------------------------------------------------------------------------

TOME 1

GENERALITES - PRECAUTIONS - SECURITE

SOMMAIRE



	Page		Page
⇒ Signalétique de sécurité	2	⇒ Manutention	
		1. mouillage et remorquage	15
⇒ Message important - Validité	3	2. levage - mise sous bossoirs	15
		3. mise sur remorque	16
⇒ Identification - Certification	4		
		⇒ Entretien	
⇒ Plaque constructeur	4-6	1. nettoyage	17-18
		2. hivernage - stockage	18
⇒ Choix et réglages du moteur		3. vérifications diverses	18
1. choix du moteur	7	4. réparation des petites crevaisons	19
2. choix de l'hélice	7	5. semi-rigides : petites réparations	19
3. installation du moteur	8		
4. réglages	8-9	⇒ Anomalies - causes / remèdes	20
⇒ Conseils de navigation	10-13	⇒ Conditions générales de garantie	21
⇒ Environnement	14	⇒ A votre service	22

SIGNALETIQUE DE SECURITE



Ce manuel contient des informations essentielles pour la protection des utilisateurs et du matériel.

Les symboles ci-dessous fournissent les avertissements propres à chaque situation.

RECOMMANDATIONS DE SECURITE

 DANGER	<p>Signifie qu'un danger extrêmement grave existe qui pourrait conduire à une grande probabilité de décès ou de blessure irréparable si des mesures particulières adaptées ne sont pas prises.</p>
 AVERTISSEMENT	<p>Signifie qu'un danger existe qui peut provoquer des blessures ou le décès si des mesures particulières adaptées ne sont pas prises.</p>
 ATTENTION	<p>Précise un rappel des mesures de sécurité ou attire l'attention sur des pratiques dangereuses qui pourraient provoquer des blessures aux personnes ou endommager le navire ou ses composants.</p>

RECOMMANDATIONS GENERALES

	<p>La procédure utilisée ou le comportement à adopter est conforme aux prescriptions.</p>
	<p>La procédure utilisée ou le comportement à adopter n'est pas conforme aux prescriptions et risque de gravement endommager le matériel ou de nuire à l'environnement.</p>
NOTE :	<p>Attire l'attention sur des indications importantes.</p>

MESSAGE IMPORTANT

Vous êtes maintenant propriétaire d'un bateau pneumatique ou semi-rigide, nous vous remercions de votre confiance et vous recommandons de lire attentivement ce manuel.

Il a été établi pour vous aider à utiliser votre bateau avec plaisir, confort et sécurité. Il contient, dans le Tome 2, la description du bateau, les équipements fournis ou installés, les méthodes et indications nécessaires à sa mise en œuvre et à son entretien. Lisez-le attentivement et familiarisez-vous avec le bateau avant de l'utiliser.

Le pilote est responsable du bon fonctionnement du bateau et de la sécurité de ses passagers. Si c'est votre premier bateau ou si vous n'êtes pas familiarisé avec nos produits, pour votre confort et votre sécurité, assurez-vous une expérience de prise en main correcte avant d'en assumer le "commandement". Votre vendeur, votre concessionnaire, votre Fédération nautique nationale ou votre club seront très heureux de vous conseiller les écoles de mer et les instructeurs compétents.

 ATTENTION	<ul style="list-style-type: none">• Nous vous conseillons de garder le manuel du propriétaire à bord de votre bateau, dans un endroit sûr et aisément accessible pour être consulté par le pilote.• Il est également recommandé de conserver jointes à votre manuel les notices délivrées par les constructeurs des équipements du bateau (moteur, batteries, etc.).• Le présent manuel fait partie des équipements du bateau et doit l'accompagner en cas de cession ou de revente.
--------------------------------------------------------------------------------------------------------	-------------------------------------------------------------------------------------------------------------------------------------------------------------------------------------------------------------------------------------------------------------------------------------------------------------------------------------------------------------------------------------------------------------------------------------------------------------------------------------------------------------------------------------------

VALIDITE

Soucieux de faire bénéficier notre clientèle de l'évolution technologique constante de nos produits, nous nous réservons le droit de modifier sans préavis les caractéristiques et la disponibilité des modèles de nos gammes.

Les informations données dans cette notice concernent les caractéristiques du bateau au moment de l'édition. Ces informations ne sont en aucun cas contractuelles.

NOTE :	Le non-respect des directives édictées dans ce manuel dégagerait la responsabilité du constructeur.
---------------	------------------------------------------------------------------------------------------------------------

HOMOLOGATION / CERTIFICATION / IDENTIFICATION

Nos bateaux sont conformes à la norme ISO 6185, établie par l'organisation internationale de standardisation. Ils sont conformes à la Directive Européenne 2013/53/EU.

Nous sommes également membre de l'Association des Fabricants de l'Industrie Nautique des Etats-Unis (NMMA), de la Fédération des Industries Nautiques (FIN) française et de L'Association pour la Plaisance Eco-Responsable (APER Plaisance) qui permet aux propriétaires de faire déconstruire leur bateau immatriculé en France en fin de vie à titre gracieux.

Pour assurer la traçabilité de votre bateau (assurances, vol, S.A.V, etc.), reportez sur la plaque (reproduction ci-dessous) les indications importantes figurant sur la plaque constructeur fixée à l'intérieur du tableau arrière.

Notez plus particulièrement le modèle (1) et le numéro de série (2) de votre bateau, ainsi que le numéro d'identification individuel gravé sur la petite plaque (11) fixée à l'extérieur du tableau arrière, proche du moteur.

① Plaque constructeur

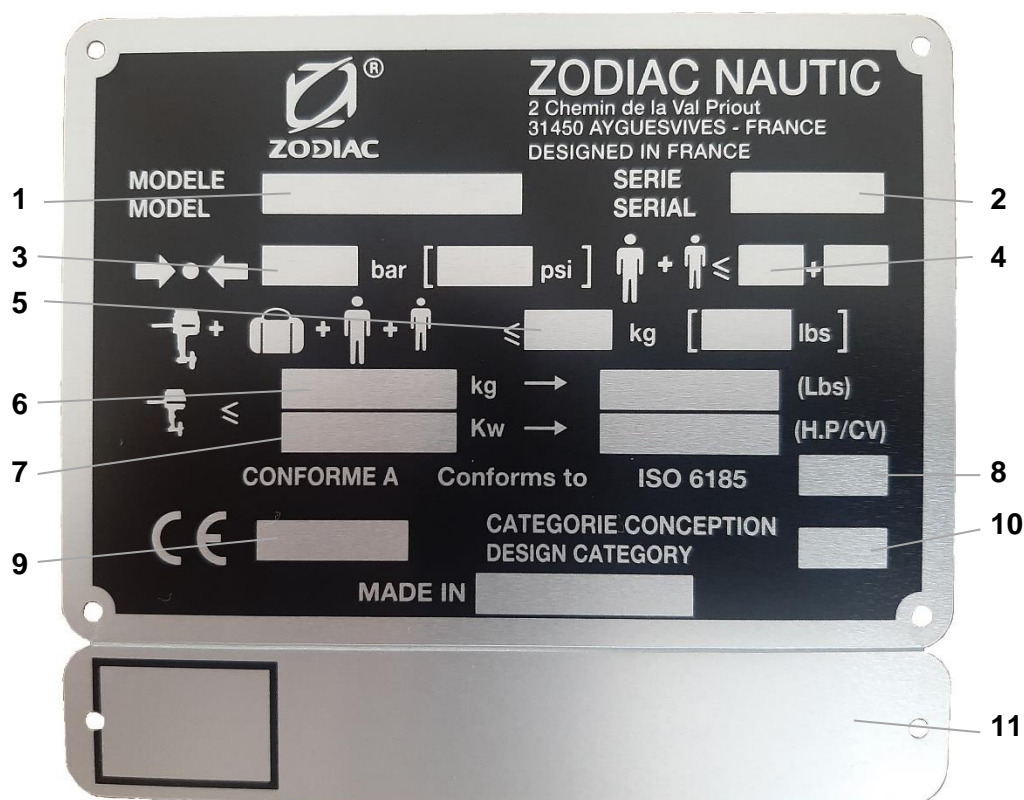

PLAQUE CONSTRUCTEUR

Les indications portées sur la plaque constructeur située sur le tableau arrière sont importantes.

Elles indiquent principalement les limitations imposées par les normes en vigueur dans la plupart des pays et par le type d'utilisation pour lequel le bateau a été conçu.

Les indications que nous vous fournissons **ne constituent pas une liste exhaustive** : les exigences en matière de navigation (armement de sécurité obligatoire du bateau, distance maximale autorisée

d'un abri, etc.) peuvent différer selon les pays ou les Etats. **Informez-vous et conformez-vous toujours aux réglementations nationales et locales du pays dans lequel vous naviguez.**

(1) **Modèle** : Nom commercial de la série.

(2) **Numéro de série** : identifie la série du bateau. A rappeler pour toute opération S.A.V, achat de pièces détachées ou d'accessoires.

(3) **Pression nominale de gonflage** des flotteurs en Bars et en PSI. D'autres parties du bateau peuvent avoir des pressions différentes. Reportez-vous au chapitre GONFLAGE (TOME 2 du Manuel du Propriétaire) ou aux indications portées sur les valves.

(4) **Nombre maximum de personnes** autorisées à bord du bateau dans le cas d'un équipement adapté (adultes + éventuellement 1 enfant) selon les normes ISO

(5) **Charge maximale totale** autorisée par le constructeur, exprimée en kilogrammes et en livres (personnes + moteur et son réservoir plein + équipement (console, sièges, roll bar + charges diverses...), définie selon la norme ISO 14945 en vigueur

(6) **Poids maximum du moteur** autorisé pour le bateau, en kilogrammes et en livres (pounds).

(7) **Puissance de motorisation maximale** autorisée pour le bateau, en kilowatts et en chevaux (Horse-Power).

(8) **La catégorie ISO** :

Votre bateau est conforme à la norme ISO 6185. Sa catégorie d'appartenance est définie en fonction de sa plage de motorisation.

Catégorie ISO	II	V	VII
Plage de motorisation en kW	0 - 4.5 kW	4.5 - 15 kW	>15 kW
Plage de motorisation en CV	0 - 6 CV	6 - 20 CV	>20 CV

(9) **CE**: Marquage de conformité à la directive européenne 2013/53/EU (à partir d'une longueur hors-tout de 2.5 m), suivi du numéro de l'organisme certificateur (pour des embarcations de catégorie de conception B seulement)

(10) **La catégorie de conception (directive Européenne 2013/53/EU)** (à partir d'une longueur hors tout de 2.5 m) :

Selon la conception de votre bateau, vous êtes habilités à naviguer en différentes catégories :

Catégorie	B	C	D
Type de navigation	"au large"	"A proximité de la côte"	"En eaux protégées"
Force du vent (échelle de Beaufort)	Jusqu'à 8 compris	Jusqu'à 6 compris	Jusqu'à 4 compris
Hauteur significative de vague (m)*	Jusqu'à 4 compris	Jusqu'à 2 compris	Jusqu'à 0,5 compris

**Elle représente la hauteur moyenne du tiers supérieur des vagues, ce qui correspond approximativement à la hauteur de vague estimée par un observateur expérimenté. Certaines vagues auront une hauteur double de cette valeur.*

Certaines de nos embarcations sont homologuées pour deux catégories de navigation. Pour permettre l'indication complète des caractéristiques relatives à chaque catégorie, elles ont deux plaques constructeur distinctes.

(11) **Petite plaque**, généralement fixée sur la face extérieure du tableau arrière et indiquant le numéro individuel d'identification de l'embarcation (CIN – Craft Identification Number).

 AVERTISSEMENT	Agissez de manière responsable : établissez votre programme de navigation en tenant compte de ces paramètres, et ne prenez pas la mer s'ils risquent d'être dépassés.
-----------------------------------------------------------------------------------------------------------	------------------------------------------------------------------------------------------------------------------------------------------------------------------------------

CHOIX DU MOTEUR ET DE L'HELICE

1. CHOIX DU MOTEUR

1.1 Puissance du moteur

- Les puissances conseillées et maximales sont données dans le tableau des caractéristiques techniques du bateau (cf. TOME 2 du Manuel du Propriétaire).
- Pour les petites puissances, préférez les moteurs à commande barre franche.

Au-delà de 25 CV, nous vous recommandons l'usage d'une commande à distance, offrant plus de confort et de sécurité.

 AVERTISSEMENT	L'utilisation d'un moteur d'une puissance supérieure à la puissance maximale autorisée (indiquée sur la plaque constructeur) peut entraîner une perte de contrôle, et vous placerait hors réglementation.
-------------------------------------------------------------------------------------------------------------	------------------------------------------------------------------------------------------------------------------------------------------------------------------------------------------------------------------

NOTE :	<p>La puissance maximale autorisée, lorsqu'elle est supérieure à la puissance maximale recommandée, doit être utilisée avec la plus extrême prudence. Elle s'adresse exclusivement à des utilisateurs expérimentés, utilisant leur bateau dans des conditions très spécifiques (transport de charges lourdes, etc.).</p> <p>Nous vous conseillons de choisir la puissance de votre moteur en fonction de l'utilisation principale que vous ferez de votre bateau et de vous référer à la puissance recommandée (cf. TOME 2).</p> <p>L'utilisation de la puissance maximum autorisée sur votre bateau risque de rendre le pilotage délicat. Insuffisamment motorisé, il risque de ne pas posséder une marge de sécurité suffisante pour contrer vents et courants.</p>
---------------	-----------------------------------------------------------------------------------------------------------------------------------------------------------------------------------------------------------------------------------------------------------------------------------------------------------------------------------------------------------------------------------------------------------------------------------------------------------------------------------------------------------------------------------------------------------------------------------------------------------------------------------------------------------------------------------------------------------------------------------------------------------------------

1.2 Poids du moteur

Le poids du moteur a une grande incidence sur la capacité à déjauger, la stabilité et les performances du bateau. A puissance égale, nous vous conseillons de choisir le moteur le plus léger.

N'installez jamais un moteur d'un poids supérieur à celui indiqué sur la plaque constructeur.

1.3 Taille de l'arbre du moteur

Il existe 4 types d'arbre du moteur : **S/L/XL/XXL**. Chaque bateau est conçu pour l'un ou pour l'autre, **sans permutation possible**. Vérifiez quel type d'arbre est adapté à votre bateau (cf. TOME 2).

2. CHOIX DE L'HELICE

- Afin de choisir l'hélice qui convient à votre usage, votre bateau et son moteur doivent être essayés sur l'eau. Demandez l'assistance de votre agent.
- L'hélice fournie avec le moteur convient en général à tout type de navigation. Cependant, en fonction de l'utilisation principale que vous ferez de votre bateau, optez pour :

Un pas court lorsque le bateau nécessite une forte poussée pour déjauger (bateau très chargé, ski nautique...).

Un pas long augmentera votre potentiel de vitesse (si le bateau est peu chargé).

 <p>DANGER</p>	<p>Tout contact avec l'hélice en rotation peut entraîner de graves blessures et même la mort.</p> <p>Restez toujours à bonne distance de l'hélice.</p>
--------------------------------------------------------------------------------------------------------	----------------------------------------------------------------------------------------------------------------------------------------------------------------------

INSTALLATION ET REGLAGES DU MOTEUR

3. INSTALLATION DU MOTEUR

- Installez le moteur dans l'axe du bateau, au centre de la plaque renfort (4).
- Bloquez à la main les vis de presse de fixation (1) et resserrez-les après 15 minutes de navigation lors de la première installation.
- Pour tous boulonnages des moteurs, se rapprocher de votre agent le plus proche
- Arrimez le moteur avec un bout de sécurité (2) au pontet (3) et aux vis de presse (1).
- Tout moteur de plus de 4 CV est équipé d'un coupe-circuit (5), élément essentiel de sécurité : attachez-le toujours à votre poignet (reportez-vous au chapitre "conseils de navigation").

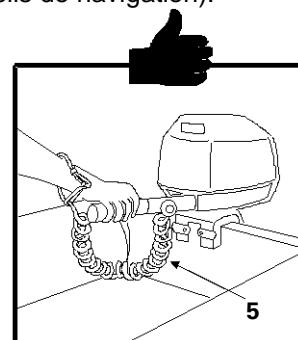
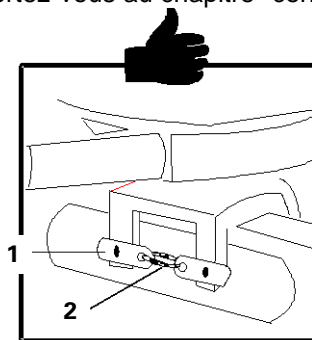
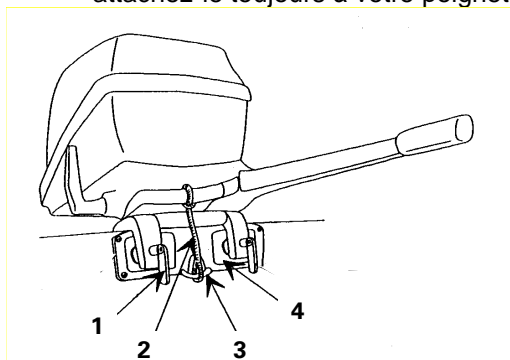

 ATTENTION	<ul style="list-style-type: none">• Le boulonnage du moteur est recommandé à partir de 10 cv et impératif au-delà de 25 cv.• A partir de 25 cv, nous recommandons l'utilisation d'une commande a distance.
---------------------------------------------------------------------------------------------------------	-----------------------------------------------------------------------------------------------------------------------------------------------------------------------------------------------------------------------------------

 AVERTISSEMENT	<ul style="list-style-type: none">• Pour les moteurs non boulonnés : vérifiez le bon serrage des vis de presse périodiquement.• Pour les commandes à distance : vérifiez régulièrement leur bon fonctionnement.
-------------------------------------------------------------------------------------------------------------	----------------------------------------------------------------------------------------------------------------------------------------------------------------------------------------------------------------------------------------

NOTE :	<p>Le boulonnage du moteur sur le tableau s'effectue après avoir affiné son positionnement. Confiez cette opération à votre agent.</p>
---------------	----------------------------------------------------------------------------------------------------------------------------------------

4. REGLAGES

Le moteur nécessite un double réglage de positionnement en hauteur et en inclinaison par rapport au tableau arrière qui a une influence directe et importante sur le comportement du bateau.

Une fois correctement calé en hauteur, le moteur ne nécessitera plus de réglage dans ce sens. Par contre, pour optimiser les performances et assurer la bonne manœuvrabilité du bateau, vous pourrez être amené à modifier l'inclinaison du moteur en fonction des conditions de navigation (barre de réglage ou trim électrique).

4.1. Hauteur du moteur

Le moteur se monte directement sur le tableau arrière. Selon les marques de moteur, au sein d'un même type d'arbre, la taille peut varier de quelques centimètres. Il est parfois nécessaire d'ajouter une cale de réglage pour assurer le bon positionnement du moteur:

Moteur calé trop haut = le moteur s'emballe (ventilation)
Moteur calé trop bas = remontées d'eau intempestives (gerbage)

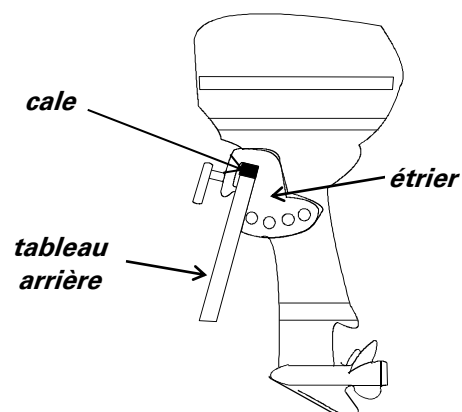

REGLAGES DU MOTEUR



4.2 Inclinaison du moteur

En général, le moteur doit être incliné de manière à ce que l'axe de l'hélice soit parallèle à la surface de l'eau.

Cependant, un réglage de l'inclinaison différent peut être recommandé dans certaines situations (reportez-vous au chapitre CONSEILS DE NAVIGATION).

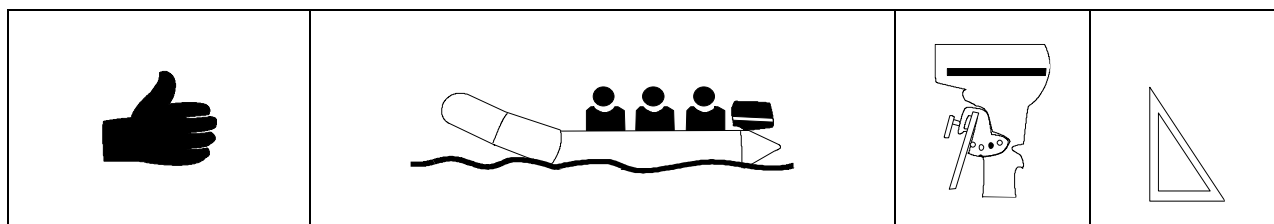
Le réglage de l'inclinaison du moteur peut s'effectuer soit manuellement, soit à l'aide du Trim pour les moteurs qui en sont pourvus.

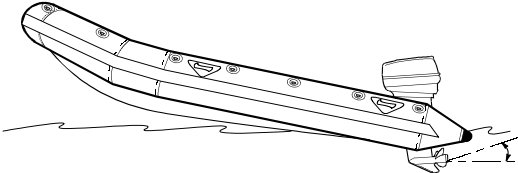
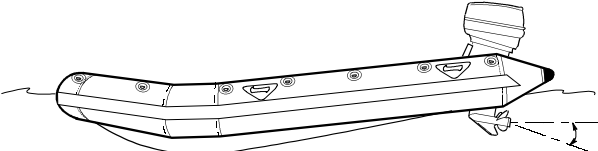

 	<p>Moteur trop éloigné du tableau : Le bateau se cabre.</p>  <p>Moteur trop près du tableau : Le bateau enfourne par l'avant.</p> 
----------------------------------------------------------------------------------------------------------------------------------------------------------------------------	--------------------------------------------------------------------------------------------------------------------------------------------------------------------------------------------------------------------------------------------------------------------------------------------------------

 AVERTISSEMENT	<p>Si le réglage de l'inclinaison de votre moteur est manuel, arrêtez-le avant d'effectuer les modifications.</p>
-----------------------------------------------------------------------------------------------------------	--------------------------------------------------------------------------------------------------------------------------

<p>NOTE :</p>	<p>Pour les informations concernant le moteur en particulier, reportez-vous à la notice du constructeur.</p>
----------------------	--------------------------------------------------------------------------------------------------------------

CONSEILS DE NAVIGATION

Répartition de la charge :

- Répartissez les charges de manière équilibrée. (Par exemple, fixer la nourrice sur l'avant peut aider à compenser le poids du moteur sur l'arrière).
- Lors de pilotage en barre franche, le pilote doit être positionné à tribord.

Exemple de bonne répartition de la charge :

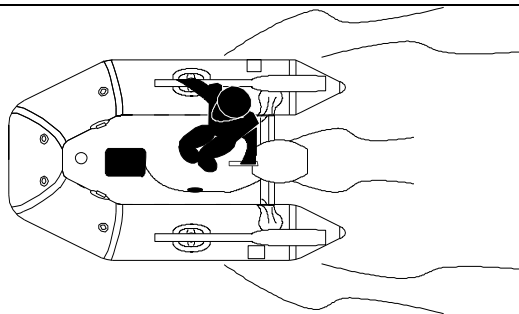

ATTENTION

Une mauvaise répartition des charges embarquées peut déstabiliser le bateau et influencer sur son comportement en mer.



ATTENTION

Lorsque le bateau est faiblement chargé, il réagit de manière très sensible. Soyez particulièrement vigilant lors des accélérations et des changements de cap.

Selon les conditions de navigation et l'état du plan d'eau, il peut être nécessaire d'apporter des modifications sur la répartition de la charge et sur l'inclinaison du moteur :

Mer forte par l'avant

Charger le bateau sur l'avant et si nécessaire régler la barre d'inclinaison du moteur

au 1er ou 2ème trou

TRIM négatif

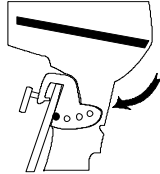

Mer forte par l'arrière

Charger le bateau sur l'arrière et si nécessaire régler la barre d'inclinaison du moteur

au 3ème ou 4ème trou

TRIM positif

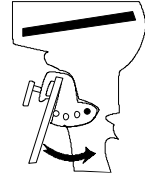

ATTENTION

Ne pas faire naviguer le bateau avec un réglage d'assiette négatif (étrave basse) à grande vitesse. Cela peut faire gîter le bateau et il peut en résulter une instabilité dans les virages. Utiliser une assiette négative pour passer de la vitesse de déplacement à la vitesse d'hydroplanage, et à des vitesses inférieures dans le clapot (si votre moteur dispose d'un trim électrique).

CONSEILS DE NAVIGATION

SECURITE AVANT TOUT : Sachez prévenir les risques d'accident

VERIFICATIONS AVANT LE DEPART

 <p>AVERTISSEMENT</p>	<p>Informez-vous et informez les passagers :</p> <ul style="list-style-type: none"><input checked="" type="checkbox"/> INFORMEZ-VOUS des réglementations et des éventuels dangers spécifiques à la navigation locale.<input checked="" type="checkbox"/> CONSULTEZ la météo : renseignez-vous sur les dangers dus aux conditions climatiques, aux marées, aux vents et courants ainsi qu'à l'état du plan d'eau.<input checked="" type="checkbox"/> PREVENEZ quelqu'un à terre de votre destination et de l'heure approximative de votre retour.<input checked="" type="checkbox"/> APPRENEZ à déterminer l'autonomie de votre bateau : la distance que vous pouvez parcourir avec un plein de carburant varie sensiblement selon l'état de la mer. Veillez à toujours disposer d'une réserve suffisante pour rejoindre un abri.<input checked="" type="checkbox"/> EXPLIQUEZ les opérations de base à tous les passagers.<input checked="" type="checkbox"/> ASSUREZ-VOUS que l'un de vos passagers sache manœuvrer en cas d'urgence.
	<p>Vérifiez le bon fonctionnement du matériel suivant l'état de la mer et l'utilisation</p> <ul style="list-style-type: none"><input checked="" type="checkbox"/> VERIFIEZ la pression du flotteur.<input checked="" type="checkbox"/> VERIFIEZ les passe-coques : enlevez les bouchons des vidè-vite et vérifiez la fermeture des nables à l'extérieur du bateau.<input checked="" type="checkbox"/> VERIFIEZ le bon fonctionnement du coupe-circuit.<input checked="" type="checkbox"/> VERIFIEZ la bonne fixation du moteur au tableau arrière.<input checked="" type="checkbox"/> VERIFIEZ et nettoyez votre filtre à essence s'il y en a un.<input checked="" type="checkbox"/> VERIFIEZ la quantité d'essence dont vous disposez.<input checked="" type="checkbox"/> PENSEZ à faire le complément d'huile si votre moteur possède un réservoir d'huile séparé.<input checked="" type="checkbox"/> ARRIMEZ votre réservoir à l'emplacement défini. Contrôlez la fixation de tous les éléments mobiles.<input checked="" type="checkbox"/> VERIFIEZ que votre moteur est au point mort avant de lancer le moteur.

MATERIEL A EMBARQUER :
(référez-vous à la réglementation de votre pays).

- Un gilet de sauvetage par personne embarquée, adapté à la morphologie de la personne et à la zone de navigation.
- Le gonfleur, les pagaies (ou les avirons), la trousse de réparation, les outils du moteur.
- Le matériel de sécurité obligatoire.
- Les papiers du bateau et votre permis.
- Une lampe électrique (en plus des feux de navigation réglementaires) en cas de navigation de nuit.

CONSEILS DE NAVIGATION

SECURITE AVANT TOUT : SACHEZ PREVENIR LES RISQUES D'ACCIDENT

REGLES A OBSERVER EN NAVIGATION

- Ayez un comportement responsable, ne mettez pas en danger votre vie et celle des autres par négligence des règles de sécurité.
- Observez les règles de priorité telles qu'elles sont définies par les règles de barre et de route et imposées par le COLREG (Règlement International pour Prévenir les Abordages en Mer – RIPAM)
- Assurez-vous de toujours disposer d'une distance suffisante pour vous arrêter ou manœuvrer si nécessaire afin d'éviter une collision.
- Ne naviguez pas à la vitesse maximale dans les zones de fort trafic, ou en cas de visibilité réduite, de vents forts ou de grosses vagues.
- Réduisez la vitesse et le sillage du bateau, par courtoisie et par mesure de sécurité pour vous-mêmes et pour autrui. Respectez les zones de limitation de la vitesse et du sillage.
- Soyez toujours maître de votre bateau et adoptez une veille constante en navigation.
- Agissez toujours avec respect et courtoisie.
- Observez les réglementations en vigueur dans votre région de navigation.
- Près du rivage, naviguez dans les chenaux balisés et à faible vitesse.
- En mer, les conditions météorologiques peuvent se dégrader rapidement. Restez toujours en mesure de regagner rapidement un abri.

 <p>ATTENTION</p>	<p>MEFIEZ-VOUS DES VENTS ET COURANTS PORTANT VERS LE LARGE !</p>
-------------------------------------------------------------------------------------------------------------	-------------------------------------------------------------------------



AVERTISSEMENT

GILETS DE SAUVETAGE : nous recommandons le port du gilet de sauvetage pendant la navigation, et, sans exception, pour les enfants et les non-nageurs.

COUPE-CIRCUIT : accrochez toujours le coupe-circuit, de préférence à votre poignet, ou à défaut, à une partie fixe du vêtement que vous portez. Prenez toutes les précautions afin d'éviter un déclenchement intempestif du coupe-circuit, qui entraînerait une perte de contrôle particulièrement dangereuse lors des manœuvres.

NI ALCOOL, NI DROGUE : ne pilotez pas après avoir consommé de l'alcool ou de la drogue. Veillez à la sobriété de vos passagers.

Ne dépassez jamais les valeurs admissibles de passagers, de puissance ou de poids.

VEILLES A CE QUE VOS PASSAGERS ne soient JAMAIS SUR L'AVANT, AVEC LES JAMBES A L'EXTERIEUR : En cas de chute, l'homme à la mer est sur le chemin de l'hélice.

VEILLES à ce que les passagers soient en position sécurisante, éviter tout changement de cap brutal, sauf en cas d'absolue nécessité.

Réduisez la vitesse dans les vagues pour le confort et la sécurité de tous.

Dans tous les cas prévenir les passagers avant la manœuvre.

EVITEZ LES VIRAGES SERRES A GRANDE VITESSE : Vous risqueriez d'éjecter vos passagers et d'être éjecté vous même

SOYEZ PARTICULIEREMENT VIGILANT AU MOMENT DE L'ACCOSTAGE : Les bras ou les jambes peuvent être blessés s'ils se trouvent en dehors du bateau au moment de la manœuvre.

N'OUBLIEZ PAS QUE L'HELICE EST UN DANGER POUR LES Baigneurs ET LES PLONGEURS :

N'autorisez pas vos passagers à se baigner lorsque le moteur est en marche, et soyez particulièrement vigilant lorsque vous naviguez à proximité d'une zone de baignade.

Le pavillon Alpha indique la présence de plongeurs : il faut impérativement passer au large (100 mètres minimum).

Ne jamais quitter le bord sans avoir amarré ou mouillé votre embarcation.

CONSEILS DE NAVIGATION

SECURITE AVANT TOUT : Sachez prévenir les risques d'accident

Règles à observer en navigation (suite)



AVERTISSEMENT

- SOYEZ VIGILANTS** : Evitez tout contact du flotteur avec des objets coupants ou des liquides agressifs (comme l'acide).

- ATTENTION A LA BATTERIE** : Méfiez-vous des décharges électriques et de l'acide qu'elle contient.

- PREVENEZ LES RISQUES D'EXPLOSION OU D'INCENDIE** : Choisissez soigneusement votre système d'alimentation en carburant et maintenez-le en bon état.

- NE PAS FUMER** lors du remplissage du réservoir à carburant.

- Si de l'essence se répand dans le fond du bateau, rincez à grande eau.

EN CAS D'ACCIDENT

En cas d'accident, ne paniquez pas et rassurez vos passagers. Sachez que le bateau, même endommagé, restera le plus souvent le meilleur abri et facilitera votre repérage. Ne tentez pas de regagner la côte à la nage.

Un bateau pneumatique est pratiquement insubmersible, même rempli d'eau. Si, après un accident, un compartiment se dégonfle, ramenez-le vers l'intérieur du bateau, rééquilibrez la charge à l'opposé du compartiment dégonflé et rentrez à vitesse réduite.

En cas de collision ou d'impact avec un objet flottant, arrêtez-vous pour examiner le fond (la coque pour les semi-rigides), les flotteurs, le moteur et ses fixations avant de rentrer à vitesse réduite.

Avant votre prochaine sortie, confiez votre bateau à votre agent qui en effectuera une inspection rigoureuse.





ATTENTION

Une négligence dans l'examen des dommages et la non-réparation qu'elle implique réduisent la résistance et la durée de vie de votre bateau et peuvent être à l'origine d'incidents.

ENVIRONNEMENT

Pour une navigation responsable

Votre bateau vous permet de découvrir la richesse naturelle du milieu marin, nous vous invitons à respecter votre environnement en appliquant ces règles de base :

	<ul style="list-style-type: none"><input checked="" type="checkbox"/> Respectez la vie des animaux marins.<input checked="" type="checkbox"/> Informez-vous sur les réglementations internationales contre la pollution en milieu marin (MARPOL) et respectez-les autant que possible.<input checked="" type="checkbox"/> Tenez-vous informé des règlements locaux de respect de l'environnement et suivez les codes de bonne pratique.<input checked="" type="checkbox"/> Si votre bateau en est équipé, ne déchargez pas les toilettes ou le contenu des réservoirs de rétention près des côtes ou dans les zones interdites. Utilisez pour cela le système de pompage des ports et des marinas.<input checked="" type="checkbox"/> Employez des peintures (antifouling) et des agents nettoyants non-polluants.<input checked="" type="checkbox"/> Eloignez-vous des zones réservées à la baignade.<input checked="" type="checkbox"/> Limitez les bruits : soyez respectueux d'autrui, évitez les bruits excessifs et les émissions intempestives de gaz d'échappement.<input checked="" type="checkbox"/> Soyez attentifs lors du remplissage du réservoir en carburant. Le carburant en excès recueilli dans le bac de rétention doit être soigneusement épongé et jeté dans une poubelle adaptée pour éviter tout rejet accidentel à la mer.
	<ul style="list-style-type: none"><input checked="" type="checkbox"/> Ne rejetez pas d'hydrocarbures (huiles et carburants) dans la nature.<input checked="" type="checkbox"/> Ne jetez pas à l'eau vos déchets et vos sacs poubelle.<input checked="" type="checkbox"/> Ne provoquez pas de remous et de sillages gênants pour les riverains.

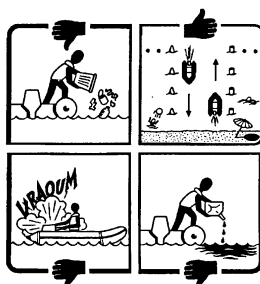

MANUTENTION

1. MOUILLAGE ET REMORQUAGE

1.1 Mouillage

Bateaux pliables : utilisez les anneaux latéraux du flotteur.

Bateaux semi-rigides : utilisez l'anneau d'étrave.

NOTE :

Au mouillage prolongé, les vide-vite peuvent être ouverts pour assurer l'évacuation de l'eau en cas de pluies abondantes.



1.2 Remorquage

Pour prendre un bateau pliable en remorque en navigation, utilisez une amarre passée en "V" dans les deux anneaux latéraux du flotteur prévus à cet effet. Pour les bateaux semi-rigides, amarrez directement à l'anneau d'étrave de la coque.

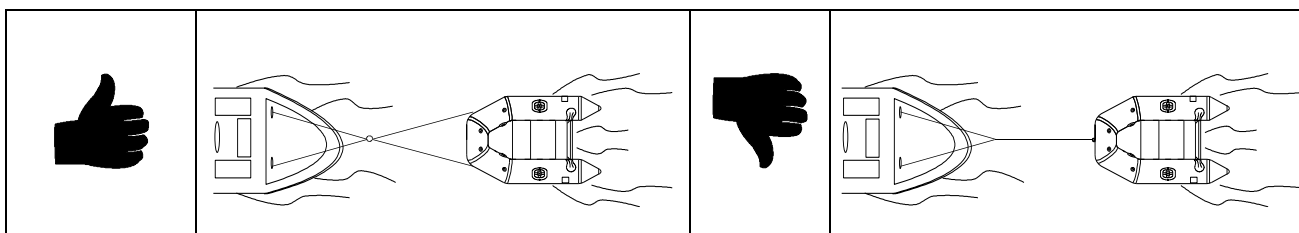
Remorquage des bateaux pliables :



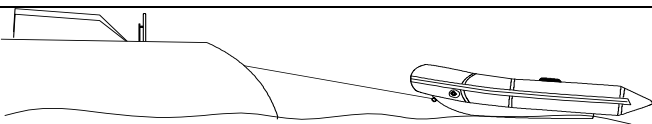

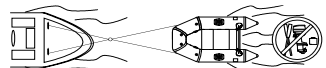
Remorquage des semi-rigides :

Utilisez l'anneau d'étrave		
Déchargez le bateau (sacs, nourriture, moteur, avirons) avant le remorquage.		

NOTE :

Le remorquage ne doit s'effectuer qu'à faible allure et par conditions météorologiques favorables (mer calme, vent faible).

 ATTENTION	<p>Les points d'ancrage qui présentent des signes visibles de détérioration doivent être remplacés. Ils doivent donc faire l'objet d'un contrôle régulier.</p>
 ATTENTION	<p>Un câble de remorquage doit toujours être amarré de manière à pouvoir être largué sous charge.</p>
NOTE :	<p>Assurez-vous que les cordages d'amarrage, câbles de remorquage, les chaînes et les lignes de mouillage ainsi que les ancres sont adéquats pour l'utilisation prévue du bateau, notamment que les lignes ou chaînes n'excèdent pas 80 % de la résistance à la rupture du point d'ancrage correspondant (cf Tome 2). Si nécessaire, demandez l'assistance de votre agent.</p>

1.3 Amarrage sur ponton

Le bateau peut être amarré sur un ponton à l'aide, au minimum, de deux amarres appelées amarres de pointe : Une à l'avant et l'autre à l'arrière.

L'amarre peut être frappée sur un point fixe et suffisamment solide du bateau :

- Bateaux semi-rigides : Taquet, anneau d'étrave, bitte d'amarrage, cadène de tableau arrière (Ne pas utiliser les points non prévus à cet effet : Ralingue, poignée, balcon, main courante, petit anneau de flotteur, ...)

- Bateaux pliables et annexes : Taquet, cadène de tableau, anneau de remorquage, poignée avant (Ne pas utiliser les points non prévus à cet effet : Ralingue, poignée de portage, petit anneau de flotteur, ...).



Le bateau doit impérativement être protégé du frottement contre le ponton par des pare-battages.

Les amarres ne doivent pas frotter contre le flotteur. Si la configuration du ponton ne permet pas de l'éviter, le flotteur doit être protégé au niveau des zones de frottement (Toile épaisse ou amarre enfilée dans un tuyau d'arrosage, par exemple).

Tout bateau amarré à un ponton doit être régulièrement surveillé et l'amarrage doit éventuellement être renforcé en fonction des conditions météorologiques.

2. LEVAGE - MISE SOUS BOSSOIRS

Pour le levage ou la mise sous bossoirs, utilisez les anneaux de levage prévus à cet effet (Voir Tome 2) ou faites-en poser par votre agent.

 AVERTISSEMENT	Aucun passager à bord lors du grutage
 ATTENTION	Le bateau doit être déchargé de tout matériel lors du grutage ou de la mise sous bossoirs. Les vide-vite doivent être ouverts et le bateau incliné sur l'arrière pour assurer l'évacuation éventuelle de l'eau.

MANUTENTION

3. MISE SUR REMORQUE

- Le bateau doit être bien gonflé.
- Les vide-vite doivent être ouverts.

3.1 Bateaux pliables :

- Réglez les rouleaux (1) de la remorque de sorte qu'ils soutiennent les flotteurs de chaque côté et à l'arrière.
- Hissez le bateau par l'avant, en utilisant les anneaux latéraux.
- Le bas du tableau arrière doit reposer sur la remorque.
- Placez le moteur en position navigation de sorte qu'il trouve un appui aménagé sur la remorque (2).
- Assurez-vous que le bateau soit bien attaché et positionné à plat.
- Retirez/amarrez tout le matériel pouvant s'envoler
- Assurez le positionnement avec des cales si nécessaire, et serrez fortement les sangles en intercalant des protections sur les flotteurs pour éviter le frottement (4).

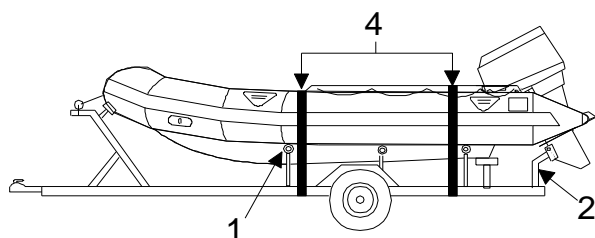

3.2 Bateaux semi-rigides :

- Réglez les rouleaux de la partie centrale de sorte que tout le poids de l'embarcation se trouve en appui sur ces rouleaux
- Régler les rouleaux ou patins latéraux de manière à stabiliser l'embarcation (attention en dehors des virures ou redans)
- Régler la distance de la main d'attelage de sorte que le tableau soit en appui sur le dernier rouleau central.
- Placez le moteur en position de navigation de sorte qu'il trouve un appui aménagé sur la remorque (3).
- Utilisez les anneaux de remorquage et l'anneau d'étrave (pour ceux qui en sont équipés) pour fixer solidement la coque sur la remorque

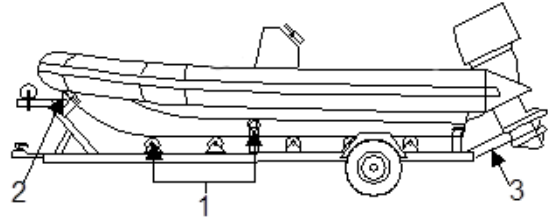

Retirez ou amarrez le matériel susceptible de s'envoler y compris les accessoires et parties amovibles

Pour des raisons de sécurité sur la route, vous devez recouvrir l'hélice d'une protection efficace.

 <p>ATTENTION</p>	<ul style="list-style-type: none">• Un mauvais positionnement du bateau sur la remorque risque de provoquer des déformations irrémédiables pouvant entraîner des vices de fonctionnement.• N'excédez jamais le poids maximum admissible par la remorque.
-------------------------------------------------------------------------------------------------------------	---------------------------------------------------------------------------------------------------------------------------------------------------------------------------------------------------------------------------------------------------------------------------------

 <p>AVERTISSEMENT</p>	<p>EN ROUTE :</p> <ul style="list-style-type: none">• Remorquez toujours le bateau déchargé de tout matériel qui ne soit pas fermement arrimé.• Aucun passager à bord lors du transport sur remorque.
-----------------------------------------------------------------------------------------------------------------	-------------------------------------------------------------------------------------------------------------------------------------------------------------------------------------------------------------------------------------

ENTRETIEN

Le flotteur de votre bateau est réalisé avec des tissus imputrescibles. Il demande un entretien simple mais indispensable pour un propriétaire consciencieux, soucieux de la longévité de son matériel.

1. NETTOYAGE

Nettoyez fréquemment votre bateau, et impérativement avant et après l'hivernage.

Il est fondamental de nettoyer votre bateau régulièrement, en particulier le flotteur. Vous pouvez également confier cette tâche à votre agent qui dispose de produits et de l'expérience nécessaire pour réaliser un nettoyage méticuleux qui prolongera la durée de vie de votre bateau.



**NE PAS UTILISER DE MATERIEL DE NETTOYAGE
A HAUTE PRESSION SUR LES TISSUS**

1.1 Nettoyage du flotteur

Flotteur gonflé :

- Ouvrez le vide-vite et rincez le bateau au jet d'eau pour évacuer le sable et les détrit.
- Nettoyez le flotteur à **l'eau douce et au savon** régulièrement, au moins une fois par mois en période d'utilisation.
- Enlevez les traces de goudron (pour les taches tenaces, utilisez le produit disponible chez votre agent).
- Inspectez le flotteur pour repérer les fuites éventuelles à l'aide d'eau savonneuse.
- Rincez à l'eau douce et laissez sécher.



Ne pas utiliser de détergents agressifs (acide, trichlore, essence, acétone) ou de produits à base de silicone. En cas de projection sur le flotteur, rincez abondamment à l'eau.

Au moment de dégonfler :

- Vérifiez le bon état et la propreté des valves et de leurs joints (étanchéité, sable, etc.).
- Vérifiez que le vide-vite ne soit pas obstrué.

1.2 Vérifiez l'étanchéité du flotteur :

Note :	<p>A l'aide de l'indicateur de pression (livré avec certains modèles ou disponible chez votre agent), mesurez la perte de pression au bout de 24 heures.</p> <p>BAISSE DE PRESSION :</p> <ul style="list-style-type: none"> • Il est normal de constater jusqu'à 20 % de baisse de pression sur 24H. (Normes ISO 6185). Si vous constatez des baisses de pression supérieures à : <p style="padding-left: 40px;">0.145 PSI (0.010 Bar) / 5 heures pour le flotteur</p> <p style="padding-left: 40px;">0.5 PSI (0.035 Bar) / 5 heures pour le plancher gonflable Haute Pression</p> <p>vérifiez l'étanchéité.</p> <ul style="list-style-type: none"> • La température influence fortement la pression. Une variation de 1°C entraîne une variation dans le même sens proche de 0.06 PSI (0.004 Bar = 4 millibars) <p>Toute baisse de pression anormale doit donner lieu à une vérification minutieuse des valves et de leurs joints. Demandez conseil à votre agent.</p>
---------------	--------------------------------------------------------------------------------------------------------------------------------------------------------------------------------------------------------------------------------------------------------------------------------------------------------------------------------------------------------------------------------------------------------------------------------------------------------------------------------------------------------------------------------------------------------------------------------------------------------------------------------------------------------------------------------------------------------------------------------------------------------------------------------------------------------------------------------------------------------------------------------------------------------------------------------------------------------------------------------------------------------------

1.3 Opération supplémentaire pour les bateaux semi-rigides : le nettoyage de la coque.

- Retirez le flotteur (pour les bateaux à flotteur amovible).
- Lavez le pont et la carène à l'eau savonneuse, rincez à l'eau douce et laissez sécher.
- Vérifiez que le vide-vite ne soit pas obstrué.
- Ouvrez le bouchon de nable pour évacuer l'eau éventuellement contenue dans la coque.
- Remontez le flotteur le cas échéant.

ENTRETIEN

1.4 Entretien de l'accastillage Inox

Nous sélectionnons des aciers inoxydables de grande qualité qui ont une résistance renforcée à la corrosion. Cependant, en milieu marin, ils sont soumis aux fortes agressions conjuguées du sel et de l'eau.

NOTE :	<p>Un Inox n'est pas inaltérable et demande un minimum de précautions et d'entretien :</p> <ul style="list-style-type: none">• Evitez de le contaminer au contact d'outils ferreux : Utilisez des outils chromés.• Evitez de rayer la surface.• Rincez-le fréquemment à l'eau douce.• Reconstituez au besoin le film protecteur avec une pâte à passiver (consultez votre agent).
---------------	-----------------------------------------------------------------------------------------------------------------------------------------------------------------------------------------------------------------------------------------------------------------------------------------------------------------------------------------------------------------------------------------------------------------------------------

1.5 Entretien de la sellerie et autres matériaux

Nettoyez la sellerie et le contre-plaqué marine à l'eau douce et au savon puis séchez.

Les vernis et les peintures ne sont pas que des éléments décoratifs, ils ont également un rôle protecteur. Dès que la surface est écaillée ou défraîchie, faites repeindre à l'aide de produits à base de polyuréthane.

2. HIVERNAGE - STOCKAGE

En dehors des périodes d'utilisation, rangez votre bateau dans un endroit propre et sec, à l'abri des écarts importants de température et des agressions climatiques extérieures.

Vous pouvez stocker votre bateau de deux façons :

- Soit plié dans son sac.
- Soit monté et légèrement sous-gonflé.

	<ul style="list-style-type: none">• En cas de stockage de longue durée au soleil (en particulier sous les tropiques), protégez votre bateau à l'aide d'une bâche de notre gamme.• Protégez votre bateau contre les petits rongeurs (rats, souris) qui peuvent trouer le pneumatique.• Si vous stockez votre bateau gonflé, veillez à ne pas lui faire subir de déformations.
-------------------------------------------------------------------------------------	-----------------------------------------------------------------------------------------------------------------------------------------------------------------------------------------------------------------------------------------------------------------------------------------------------------------------------------------------------------------------------------------------------------------------------------

3. VERIFICATIONS DIVERSES

- Vérifiez périodiquement l'état de la timonerie, des drisses et des sangles. Faites changer les pièces qui présentent des traces d'usure.
- Contrôlez fréquemment le serrage des vis et écrous, et en particulier le boulonnage du moteur.
- Examinez régulièrement l'état du système d'alimentation en carburant. Faites changer les pièces qui présentent des traces d'usure ou de vieillissement. Vérifiez le serrage des colliers.

ENTRETIEN

4. REPARATION DES PETITES CREVAISONS

NOTE :	<p>Votre bateau est livré avec un nécessaire de réparation qui doit être à bord.</p> <p>Les réparations en navigation sont délicates. Respectez au maximum et autant que possible les instructions ci-dessous. Dès le retour à terre, refaites la réparation ou faites-la refaire par votre agent.</p>
---------------	--------------------------------------------------------------------------------------------------------------------------------------------------------------------------------------------------------------------------------------------------------------------------------------------------------

NECESSAIRE DE REPARATIONS	<p>Pour nettoyer :</p> <ul style="list-style-type: none">➤ Solvant léger pour le nettoyage (acétate d'éthyl) (non fourni) <p>Pour réparer :</p> <ul style="list-style-type: none">➤ Pièces de tissu.➤ Tube de colle ou patch de réparation mis à disposition (Patch'n Go)➤ Pinceau – lissette (non fournis)➤ Fiche d'instruction
CONDITIONS POUR UNE QUALITE DE REPARATION OPTIMALE	<ul style="list-style-type: none">➤ Taux d'humidité tempéré : hygrométrie <60 %.➤ Température comprise entre 18 et 25°C.➤ Réparer à l'abri du soleil et au sec.➤ Flotteur à plat, dégonflé.
PREPARATION	<ul style="list-style-type: none">➤ Repérez les fuites (avec de l'eau savonneuse si fuite non visible à l'œil)➤ Découpez une pièce ronde débordant d'au moins 5 cm la déchirure du flotteur ou utilisez une pièce adaptée du nécessaire de réparation.➤ Tracez sur le flotteur l'emplacement de la pièce.➤ Nettoyez la pièce et l'emplacement autour de la déchirure au solvant➤ Laissez sécher 5 minutes.
ENCOLLAGE	<ul style="list-style-type: none">➤ Encollez le flotteur et la pièce, passer sur chacun 3 fines couches de colle, en laissant sécher 3 à 5 minutes entre chaque couche (la colle ne doit plus adhérer au doigt mais ne doit pas être trop sèche).

<p>POSE DE LA PIECE</p>	<ul style="list-style-type: none"> ➤ Après séchage de la dernière couche, posez la pièce sans appuyer pour pouvoir rectifier un éventuel mauvais centrage. ➤ Pressez du centre vers l'extérieur pour chasser les éventuelles bulles d'air. ➤ Lissez fortement la pièce avec un objet arrondi en commençant par le centre de la pièce. ➤ Nettoyez si nécessaire l'excédent de colle au solvant.
<p>AVANT DE REUTILISER LE BATEAU</p>	<ul style="list-style-type: none"> ➤ Evitez si possible d'exposer la réparation au soleil ou à la pluie. ➤ Laissez sécher pendant 24 heures avant de procéder au regonflage.
<div style="text-align: center;">  <p>ATTENTION</p> </div>	<p>Ne laissez pas le tube de colle en plein soleil ou à proximité d'une flamme ou d'une source de chaleur.</p> <p>Travaillez toujours dans un local aéré, évitez de respirer les vapeurs de colle, de l'ingérer, et évitez le contact avec la peau.</p>

5. SEMI-RIGIDES : REPARATION DES RAYURES SUR LA COQUE

- Les petites rayures peuvent être atténuées ou enlevées en utilisant de la pâte à polir et de la ouate à lustrer.
- Les rayures plus profondes peuvent être réparées à l'aide de mastic polyester ou de gelcoat de réparation. Dans ce cas, demandez conseil à votre agent.

<p>NOTE :</p>	<p>En cas de réparation importante du flotteur ou de la coque, consultez votre agent qui dispose des produits, des outillages et de l'expérience nécessaires pour réaliser des réparations de grande qualité.</p>
----------------------	-------------------------------------------------------------------------------------------------------------------------------------------------------------------------------------------------------------------

ANOMALIES : CAUSES ET REMEDES

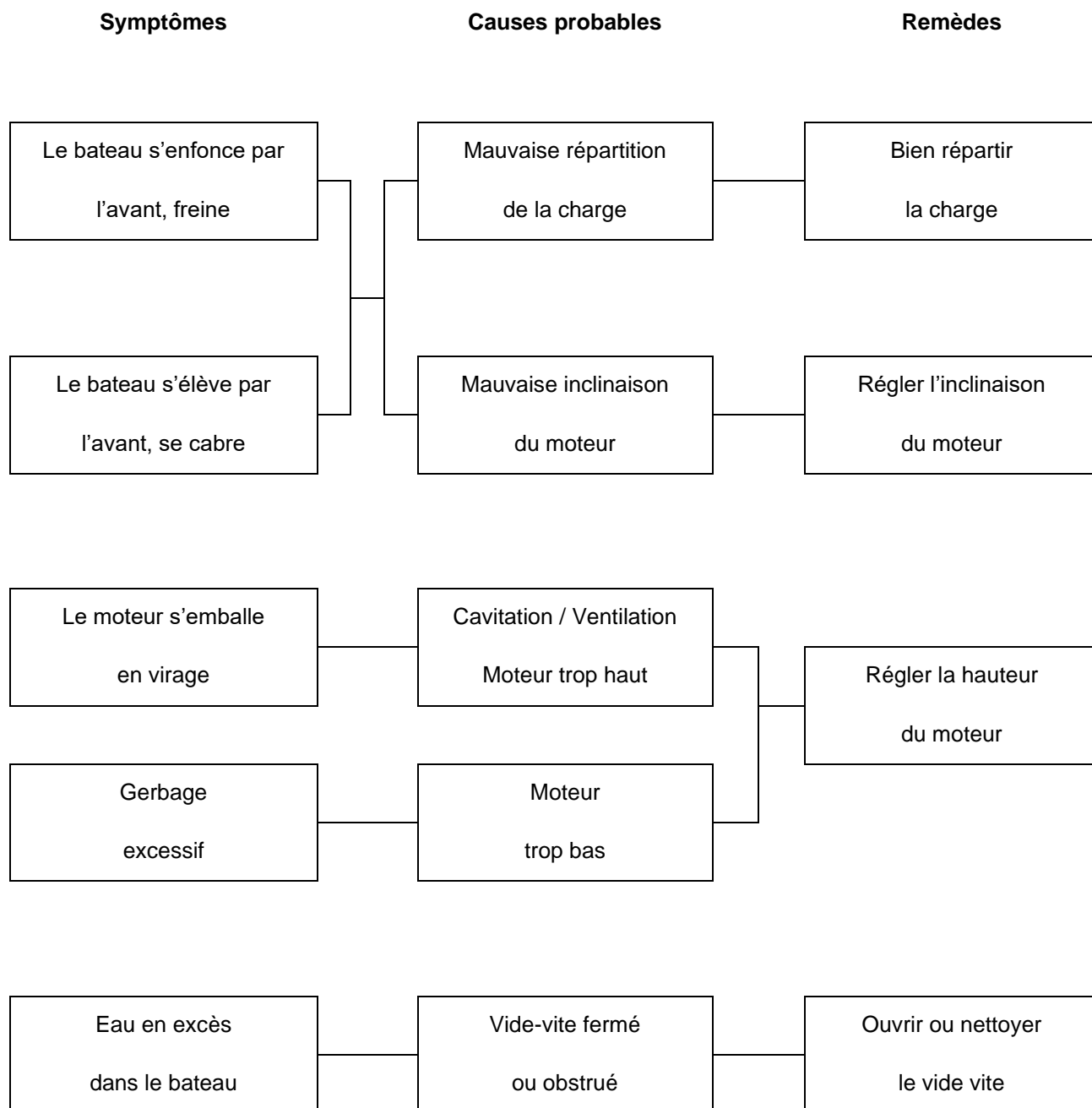

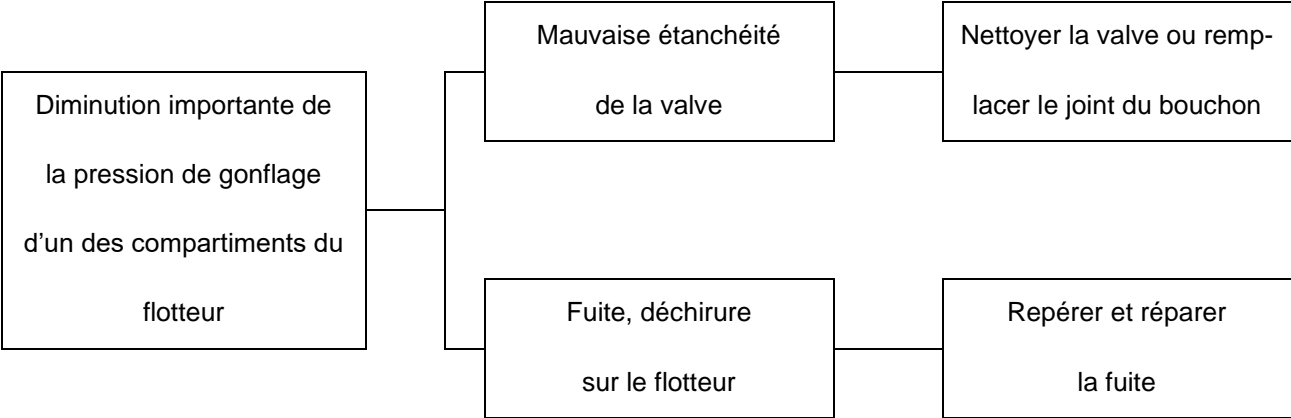
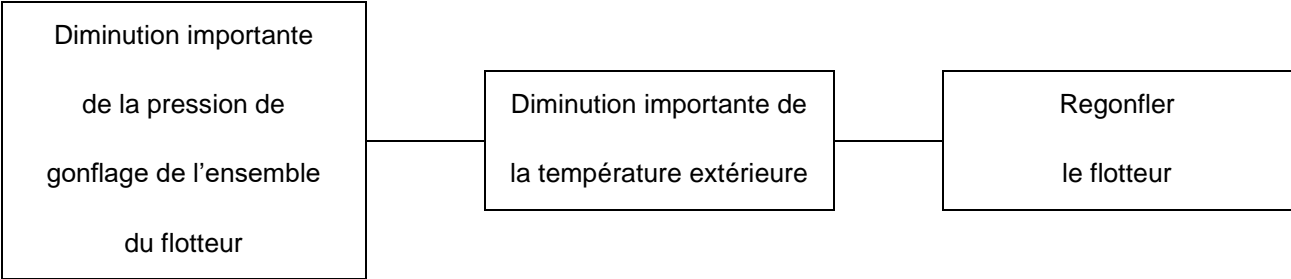

CONDITIONS GENERALES DE GARANTIE

NOTE :	<p>Assurez-vous auprès de votre agent qu'il a bien inscrit votre bateau pour la mise en place de la garantie constructeur. Il vous informera sur les conditions de son application.</p> <p>Tout appel à cette garantie doit également passer par votre agent.</p>
---------------	---------------------------------------------------------------------------------------------------------------------------------------------------------------------------------------------------------------------------------------------------------------------------------

Les principales restrictions à l'application de cette garantie sont les suivantes :

- Le bateau ne devra pas avoir été transformé, modifié, surmotorisé ou utilisé hors de son domaine d'emploi (courses, usages professionnels).
- Le poids de charge maximum ne devra pas avoir été dépassé.
- Les pressions de gonflement, les procédures de montage/démontage et de manutention devront avoir été respectées.
- L'entretien et les conditions de stockage ne devront pas avoir été négligés.
- Cette garantie ne s'applique pas aux éléments non fournis par le constructeur, ou aux défauts résultant du montage de ces éléments.

 AVERTISSEMENT	<p>Votre bateau a été conçu conformément aux normes et pour une utilisation spécifique. Les modifications, transformations ou sur-motorisation opérées dans le but d'en modifier les performances font prendre des risques graves à l'utilisateur et entraînent la suppression de la garantie.</p>
-------------------------------------------------------------------------------------------------------------	-----------------------------------------------------------------------------------------------------------------------------------------------------------------------------------------------------------------------------------------------------------------------------------------------------------

NOTE :	<p>Les réparations au titre de la garantie seront assurées exclusivement par notre réseau agréé point garantie</p>
---------------	---------------------------------------------------------------------------------------------------------------------------

Z NAUTIC
2 Chemin La Val Priout
31450 Ayguesvives
FRANCE

611957 - A

Owner's Manual

Volume 1

GENERAL INFORMATION-PRECAUTIONS-SAFETY

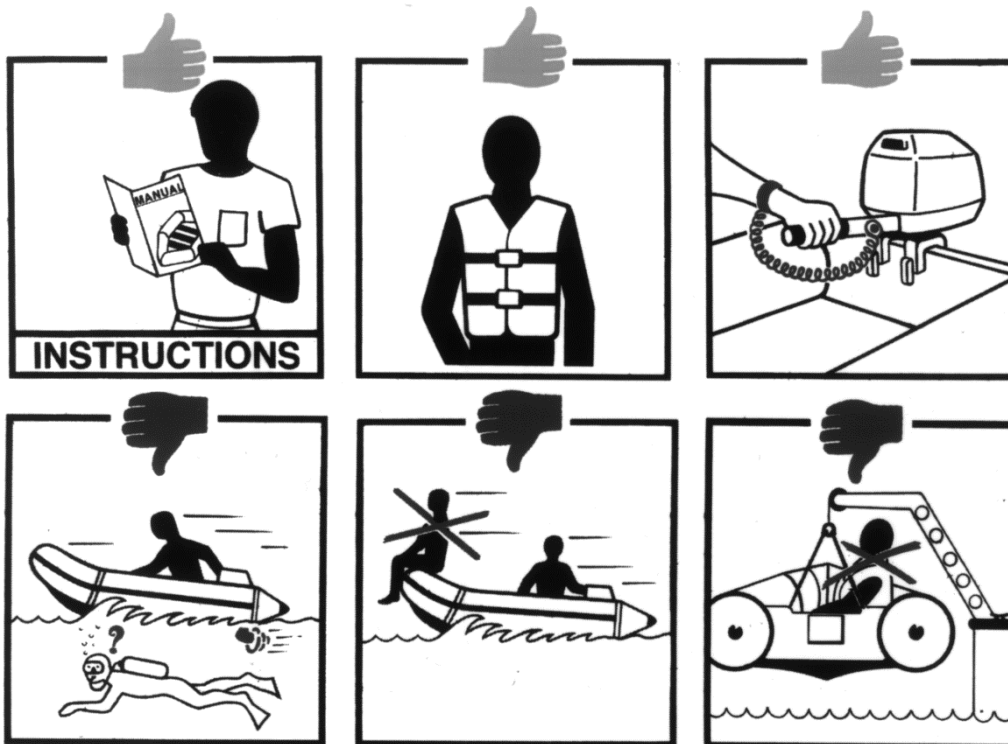

WARNING

- CAREFULLY READ THIS MANUAL BEFORE PUTTING YOUR BOAT INTO SERVICE
- THE OWNER'S MANUAL IS DIVIDED INTO TWO VOLUMES

611957 - A

<p>NOTE:</p>	<p>The owner's manual is divided into two volumes:</p> <p>Volume 1</p> <p>Deals with operating precautions and safety recommendations that must be observed.</p> <p>Volume 2</p> <p>Deals with technical specifications and assembly procedure of the boat and its equipment.</p>
---------------------	--------------------------------------------------------------------------------------------------------------------------------------------------------------------------------------------------------------------------------------------------------------------------------------------------------

	<p>Boats are fun, and we want you to enjoy it for years to come.</p> <p>Please spend some time reading your Owner's Manual and Safety Precautions to understand the operation and safety considerations of this boat.</p> <p>And don't forget: Safety First!</p>
-------------------------------------------------------------------------------------	---------------------------------------------------------------------------------------------------------------------------------------------------------------------------------------------------------------------------------------------------------------------------------------

VOLUME 1

GENERALITIES - PRECAUTIONS - SECURITY



CONTENTS

	Page		Page
⇒ Recommendation signs	2	⇒ Handling	
		1. mooring and towing	15
⇒ An important Message - Validity	3	2. lifting / davits	15
		3. hauling on trailer	16
⇒ Certification - Identification	4		
		⇒ Maintenance	
⇒ Manufacturer's ID plate	4-6	1. cleaning	17-18
		2. wintering - storage	18
⇒ Type of motor and adjustment		3. regular verifications	18
1. type of motor	7	4. how to repair small punctures	19
2. type of propeller	7	5. rigid inflatable boats: small repairs	19
3. installing the motor	8		
4. adjustment	8-9	⇒ Troubleshooting guide	20
⇒ Operating instructions	10-13	⇒ Warranty - General conditions	21
⇒ Environment	14	⇒ At your service	22



RECOMMENDATIONS SIGNS

This manual contains essential information for the protection of users and equipment.
The symbols below are advisories relative to various types of situations.

SECURITY RECOMMENDATIONS

 DANGER	<p>Means that there is an extremely serious danger that could result in a very likely probability of death or fatal injury if specific steps are not taken.</p>
 WARNING	<p>Means that there is a danger that could result in injury or death if specific steps are not taken.</p>
 WARNING	<p>Provides a reminder of safety measures or draws attention to dangerous practices that could cause injuries or damage the boat or its components.</p>

GENERAL RECOMMENDATIONS

	<p>This procedure or behaviour complies with the instructions.</p>
	<p>This procedure or behaviour does not comply with the instructions thus risking damage equipment.</p>
<p>NOTE:</p>	<p>Draws attention to important indications.</p>

AN IMPORTANT MESSAGE

Congratulations on your purchase of an inflatable boat. We take pride in bringing you a quality product which will offer you years of pleasure. Your boat is an investment which deserves your care and attention.

It was drawn up to help you get pleasure out of using your boat in complete comfort and safety. It contains, in Volume 2, the description of the boat, the equipment supplied or installed, and methods and indications needed for its use and servicing. Read it carefully, and familiarize yourself with the craft before using it.

Serious personal injury and death can occur in and around boats. To prevent these tragic accidents, please read, understand and strictly enforce all safety rules. If this is your first boat, or if you are not familiar with our products, please make sure you practice and get used to it before you assume its command. Your salesperson, your dealer, your national nautical Federation or your club will be very happy to advise you on boating schools and competent instructors.

 WARNING	<ul style="list-style-type: none"> • We advise you to keep the owner's manual on board your boat, in a safe, readily accessible place to allow it to be consulted by the driver. • IT IS ALSO RECOMMENDED TO KEEP WITH YOUR MANUAL ANY INSTRUCTIONS ISSUED BY THE MANUFACTURERS OF THE BOAT'S EQUIPMENT (ACCESSORIES, ETC.). • THIS MANUAL IS PART OF THE BOAT'S EQUIPMENT AND MUST ACCOMPANY IT IF TRANSFERRED OR SOLD.
------------------------------------------------------------------------------------------------------	--------------------------------------------------------------------------------------------------------------------------------------------------------------------------------------------------------------------------------------------------------------------------------------------------------------------------------------------------------------------------------------------------------------------------------------------------------------------------------

VALIDITY AND COMPOSITION

Our commitment to constantly keep pace with the latest advances in technology requires that we reserve the right to change the characteristics or the availability of a boat model for the benefit of our customers.

The information in this manual concerns this boat at the time of issue. This is in no case contractual.

NOTE:	We take no responsibility for the consequences of actions not complying with the instructions given in this manual.
--------------	----------------------------------------------------------------------------------------------------------------------------

APPROVAL / CERTIFICATION / IDENTIFICATION

Our boats comply with ISO standard 6185, established by the International Standards Organization, and with European Directive 2013/53/EU.

We are also a member of the American Nautical Manufacturers Association (NMMA), the French Nautical Industries Federation (FIN) and the Association for Eco-Responsible Yachting (APER Plaisance) which allows owners have their boat (registered in France) dismantled free of charge at the end of its service life.

Record below the data indicated on the manufacturer's plate provided on the inside of the transom. You may need them to help identify your boat for insurance purposes in case of theft or for after-sales service.

Carefully record the model (1) and the serial number (2) of your boat, and the ID number provided on the plate outside the transom, near the outboard (XDC) (11).

① Manufacturer's ID plate

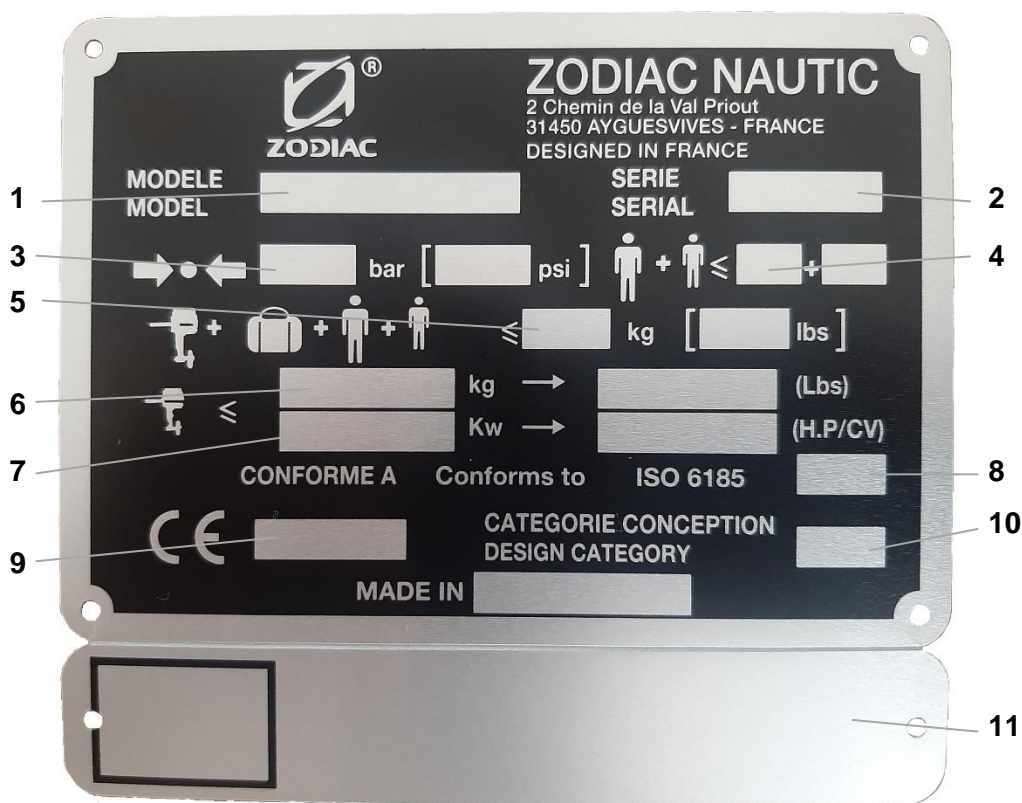

MANUFACTURER'S ID PLATE

The indications on the manufacturer's plate on the transom are important:

They give information about limitations imposed by local or national regulations.

However, these indications **are not a complete list**: the safety requirements (the boat's mandatory safety equipment, maximum authorized distance you can navigate from a shelter, etc.) may change according to the country or state **Always refer to local regulations to be informed on additional requirements.**

(1) **Model:** Commercial name of the model.

(2) **Serial number:** boat's serial identification number. To be provided for any after-sales service operation, and for the purchase of spare parts or accessories.

(3) **Nominal inflation pressure** of buoyancy tubes in bar and PSI. Other parts of the boat may have different inflation pressures. Refer to the INFLATION chapter (VOLUME 2 of the Owner's Manual) or to the indications on the valves.

(4) **Maximum number of passengers** allowed on board the boat in the case of adapted equipment (adults + possibly 1 child) as per ISO standards

(5) **Maximum load capacity** of the boat allowed by the constructor expressed in kilograms and in pounds (people + engine and its fuel tank filled to the top + diverse loads, etc.), defined as per the current version of standard ISO 14945

(6) **Maximum engine weight** allowed by the constructor for the boat expressed in kilograms and in pounds (lbs)

(7) **Maximum engine power** allowed by the constructor for the boat expressed in kilowatts and in Horse Power (HP)

(8) **ISO Category:**

Your boat complies with ISO 6185 Standard. The engine rating defines its category.

ISO CATEGORY	II	V	VII
Motor rating in kW	0 - 4.5 kW	4.5 - 15 kW	>15 kW
Motor rating in HP	0 - 6 CV/HP	6 - 20 CV/HP	>20 HP

(9) **CE:** Sign of the certification to the European Directive 2013/53/ EU (for overall length > 2.5 m), followed by the certification organism number and the year of CE certification – for B design category only).

(10) **Design category (European directive 2013/53.EU)** (for overall length > 2.5 m):

In Europe, your boat has been designed to navigate under different categories:

Category	B	C	D
Navigation	"offshore"	"inshore"	"sheltered waters"
Wind speed (Beaufort scale)	Up to and including 8	Up to and including 6	Up to and including 4
Wave significant height (m)*	Up to and including 4	Up to and including 2	Up to and including 0.5

*It represents the average height of the upper third of the waves, which approximately corresponds to the wave height estimated by an experienced observer.. *Some waves will have a height double this value.*

Some of our boats are approved for two navigation categories. In order to fully indicate the characteristics relating to each category, they have two separate manufacturer's plates.

(11) **Small plate** with the Craft Identification Number (generally fixed on the external side of the transom) needed for any after-sale service operation.

 WARNING	<p>Be responsible, take notice of these parameters when you plan your navigation program, and do not put to sea if the conditions are likely to exceed these parameters.</p>
-----------------------------------------------------------------------------------------------------	------------------------------------------------------------------------------------------------------------------------------------------------------------------------------

TYPE OF MOTOR AND ADJUSTMENT

1. TYPE OF MOTOR

1.1 Motor's power

- The maximum and recommended powers are listed in the table of technical specifications (see VOLUME 2 of the Owner's Manual).
- For smaller outboards, go for tiller control, giving direct control over the boat and allowing for quick manoeuvring.

Above 25 CV/HP, for greater comfort and safety, we recommend that you choose a steering console.

 WARNING	<p>Never use motor power higher than indicated on the manufacturer's id plate: It could also result in loss of control, and you would be breaking the law.</p>
-------------------------------------------------------------------------------------------------------	-----------------------------------------------------------------------------------------------------------------------------------------------------------------------

NOTE:	<p>The maximum authorized power, when greater than the maximum recommended power, must be used with extreme caution. It is directed at experienced users using their boats for very specific purposes (carrying heavy loads, etc.).</p> <p>It is recommended that you choose your outboards' power in accordance with your principal boating activities. Refer to the recommended power (see VOLUME 2).</p> <p>Over-powered your boat can be difficult to control. Under-powered and you may not have that margin of security necessary to go upwind or against the currents.</p>
--------------	------------------------------------------------------------------------------------------------------------------------------------------------------------------------------------------------------------------------------------------------------------------------------------------------------------------------------------------------------------------------------------------------------------------------------------------------------------------------------------------------------------------------------------------------------------------------------------

1.2 Motor weight

The motor's weight has a great influence on the planning, stability and performances of the inflatable boat. For equal power, we recommend that you choose a light motor.

You must never exceed the maximum authorized motor weight indicated on the manufacturer's plate.

1.3 Motor shaft Length

Four different shaft lengths are available: **S/L/XL/XXL**. Each boat is designed for a specific shaft, **interchanging is not possible**. Check which length is required for your boat, and use the proper size (refer to Owner's Manual volume 2).

2. TYPE OF PROPELLER

- In order to choose the optimal propeller for your principal use, your boat and its motor must be tested at sea. Ask your Dealer to assist you.
- In general, the propeller provided with the motor is adapted to all types of navigation. Nevertheless, according to the principal use you intend to make of the boat, go for:

A **lower pitch** when the boat is heavily loaded or used for water skiing.

A **higher pitch** will increase the speed potential (if the boat is lightly loaded).

 DANGER	All contact with a rotating propeller can result in serious injury or even death. KEEP AWAY FROM THE PROPELLER.
----------------------------------------------------------------------------------------------------	--------------------------------------------------------------------------------------------------------------------------------------

INSTALLING AND ADJUSTING THE MOTOR

3. INSTALLING THE MOTOR

- Install the motor along the centreline of the boat, in the middle on the mounting plate (4)
- Fully tighten the tightening plate (1) by hand and check that they are still properly tightened after 15 minutes of running.
- For all questions regarding engine bolting, please contact your nearest dealer.
- Secure the motor to the loop (3) on the motor tightening plate (1) with a safety cable (2).
- All engines above 4 HP are equipped with a safety stop lanyard (5), which is an essential safety element: always attach it to your wrist (refer to the chapter entitled "Operating instructions").

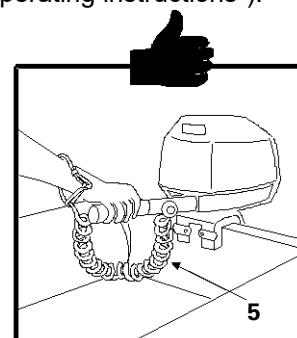
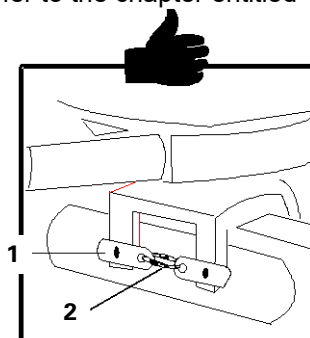
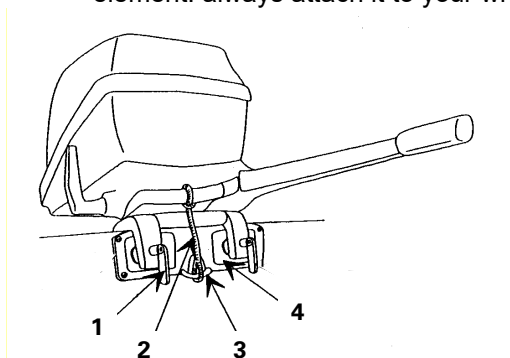

WARNING

- The bolting of the motor to the transom is suggested from 10 HP and highly recommended from 25 HP and above.
- FOR ALL OUTBOARDS FROM 25 HP AND ABOVE WE RECOMMEND THE INSTALLATION OF A REMOTE STEERING UNIT.



WARNING

- For engines that are not bolted to the transom: regularly check that the tightening plates stay properly tightened.
- For remote controls: regularly check their operation.

NOTE:

Bolting is to be done once the motor is evenly positioned. Have the motor bolted to the transom by your dealer.

4. ADJUSTMENTS

The motor requires a double position adjustment in tilt and height that greatly and directly impacts on the boat's attitude.

You will have to adjust the motor in height only once. On the contrary, to optimize performances and good manoeuvrability, you will have to adjust the angle of the motor in relation to the transom depending on the navigation conditions (adjustment bar or electric trim).

4.1. Motor height

The motor is mounted on the transom... Depending on the brand of engine, using the same shaft type the size may vary by a few centimetres. A shim is sometimes required to ensure that the engine is positioned properly.

Motor adjusted too high = ventilation may occur with loss of forward thrust (cavitation)
 Motor adjusted too low = loss of speed and more difficult steering may occur (splashes).

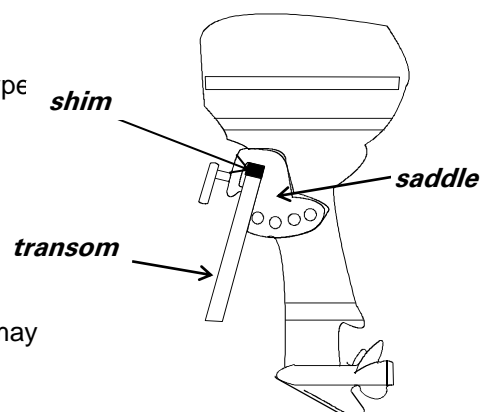

ADJUSTING THE MOTOR



4.2 Motor position (TRIM)

As a rule, the motor must be positioned so that the axis of the propeller is parallel with the water surface.

However, an adjustment of the tilt is often recommended (see the chapter Operating instructions of this manual).

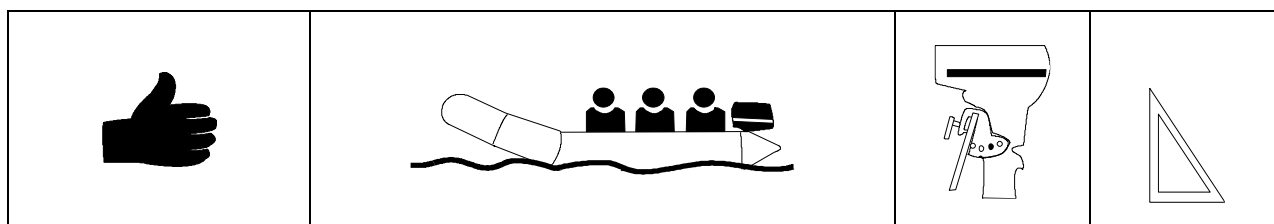
The adjustment of the tilt can be manual or assisted by an electric Trim (when equipped).

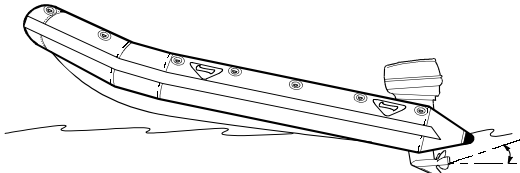
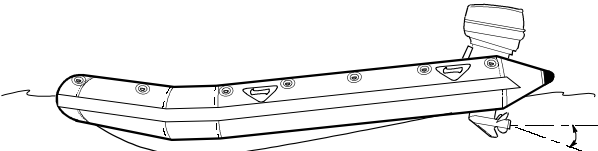

 	<p>Motor tilted outwards too far from the transom. the boat will porpoise.</p>  <p>Motor tilted inwards too near the transom: the boat will nose down.</p> 
----------------------------------------------------------------------------------------------------------------------------------------------------------------------------	---------------------------------------------------------------------------------------------------------------------------------------------------------------------------------------------------------------------------------------------------------------------------------------------------------------------------------

 <p>WARNING</p>	<p>If your engine has manual tilt adjustment, stop the engine before making any modifications.</p>
---------------------------------------------------------------------------------------------------------	-----------------------------------------------------------------------------------------------------------

<p>NOTE:</p>	<p>For specific information concerning the motor itself, refer to the motor's manual.</p>
---------------------	-------------------------------------------------------------------------------------------

OPERATING INSTRUCTIONS

Distribution of the load:

- Evenly distribute the load. (For example, fixing the fuel tank on the front can help to offset the weight of the outboard).
- When using a hand tiller, we recommend that the driver remains on the starboard side.

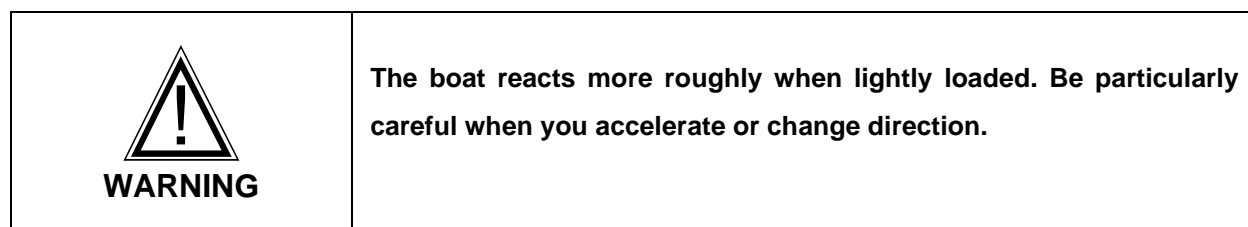
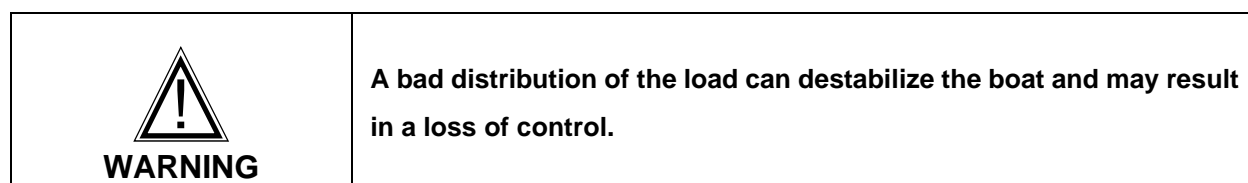
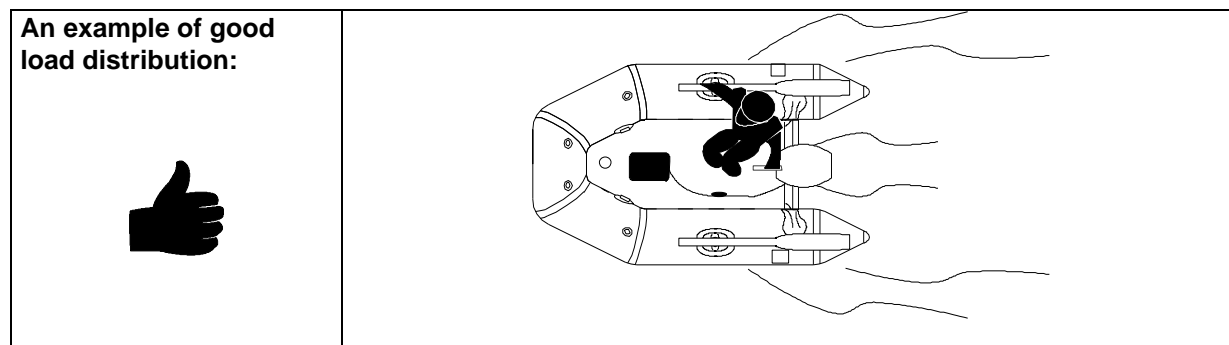

Depending on the navigation conditions and the waves direction, it may be necessary to adjust the load distribution and the trim.

In a "head on" sea

- load the bow, and if necessary, adjust the engine's inclination
- the tilt pin should be in the 1st or 2nd hole position

Negative TRIM

In a "following" sea

- load the stern, and if necessary, adjust the engine's inclination
- the tilt pin should be in the 3rd or the 4th hole position

Positive TRIM

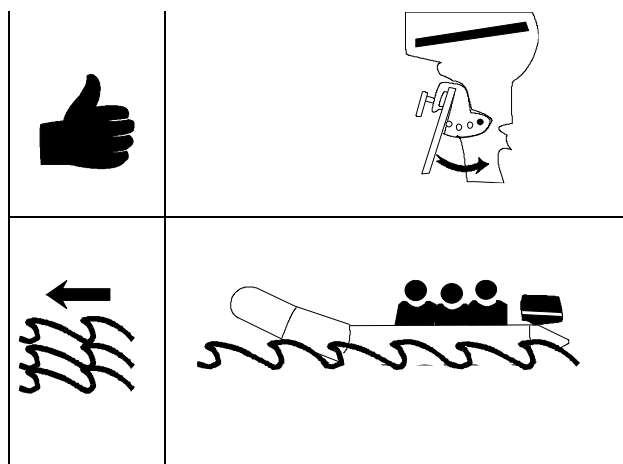
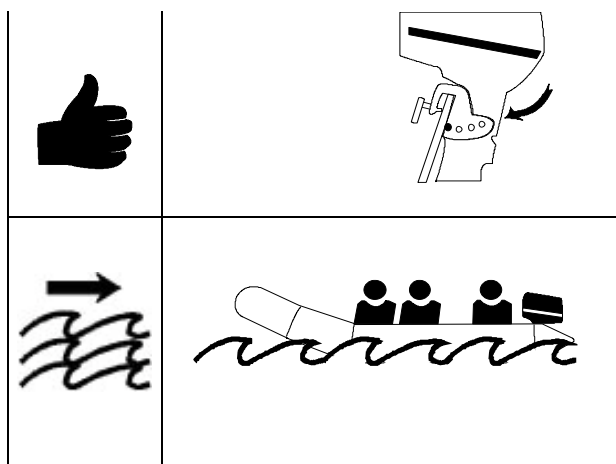

 WARNING	<p>Do not operate the boat at high speed with a negative trim setting (low bow). This can cause the boat to list and may result in instability in turns. Use a negative trim setting to shift from travelling speed to hydroplaning speed, and at lower speeds in chop (if your engine is equipped with an electric trim).</p>
-------------------------------------------------------------------------------------------------------	--------------------------------------------------------------------------------------------------------------------------------------------------------------------------------------------------------------------------------------------------------------------------------------------------------------------------------

OPERATING INSTRUCTIONS

SAFETY FIRST: Learn how to avoid accidents

CHECK-LIST BEFORE DEPARTING

 WARNING	<p style="text-align: center;">Get required information and inform other passengers:</p> <ul style="list-style-type: none"> <input checked="" type="checkbox"/> GET INFORMED ON LOCAL REGULATIONS AND HAZARDS RELATED TO WATER ACTIVITIES AND BOAT OPERATION. <input checked="" type="checkbox"/> CHECK weather forecast, local currents, tides and wind conditions. <input checked="" type="checkbox"/> ADVISE someone on land of the time you plan to be back. <input checked="" type="checkbox"/> LEARN HOW TO DETERMINE THE DISTANCE YOU CAN COVER WITH A FULL FUEL TANK, AND REMEMBER THAT BAD WEATHER CONDITIONS CAN ALTER THIS. Always be sure you have enough fuel to reach a shelter. <input checked="" type="checkbox"/> EXPLAIN basic boat operation to all passengers. <input checked="" type="checkbox"/> BE SURE that one of your passengers can operate the boat in case of emergency.
	<p style="text-align: center;">Check that all equipment is in good operating condition in keeping with the sea conditions and the intended use</p> <ul style="list-style-type: none"> <input checked="" type="checkbox"/> CHECK the pressure of the buoyancy tube. <input checked="" type="checkbox"/> CHECK the thru-hull openings: remove the self-bailer plugs and check that the drain holes are closed on the outside of the boat. <input checked="" type="checkbox"/> CHECK that the stop switch is in proper working order. <input checked="" type="checkbox"/> CHECK that the engine is securely bolted to the transom. <input checked="" type="checkbox"/> CHECK and clean your fuel filter, if so equipped. <input checked="" type="checkbox"/> CHECK how much fuel you have. <input checked="" type="checkbox"/> DO NOT FORGET to fill up the oil level if your motor has a separate oil tank. <input checked="" type="checkbox"/> CHECK the security of your fuel tank. Check that all mobile elements are secured. <input checked="" type="checkbox"/> BE SURE motor is not in gear before starting.

	<p style="text-align: center;">EQUIPMENT ON BOARD: (Check the laws and regulations of the country or locality in which you are boating).</p> <ul style="list-style-type: none"><input checked="" type="checkbox"/> One personal flotation device (PFD) per person, adapted to the person's morphology and area of operation.<input checked="" type="checkbox"/> The foot-pump, paddles (or the oars), repair kit and tool kit.<input checked="" type="checkbox"/> The mandatory safety equipment.<input checked="" type="checkbox"/> The boat papers and your boating license.<input checked="" type="checkbox"/> Lights are required if operating after dark.
--	-----------------------------------------------------------------------------------------------------------------------------------------------------------------------------------------------------------------------------------------------------------------------------------------------------------------------------------------------------------------------------------------------------------------------------------------------------------------------------------------------------------------------------------------------------------------------------------------------------------------------------------------------------------------------------------------------------------------------------

OPERATING INSTRUCTIONS**SAFETY FIRST: LEARN HOW TO AVOID ACCIDENTS****RULES TO OBSERVE DURING NAVIGATION**

- Be responsible: do not neglect the safety rules, this could jeopardize your life and the lives of others.
- Observe the rules of priority as defined by the steering and sailing rules established by the International Regulations for Preventing Collisions at Sea (COLREG - *Collision Regulations*)
- Ensure that you always have sufficient distance to stop or manoeuvre to avoid a collision, if necessary.
- Do not navigate at maximum speed in areas of heavy traffic, low visibility, strong winds or high waves.
- Reduce the boat's speed and wake as a courtesy and safety measure for yourself and others. Observe the speed and wake limit zones.
- Learn to always keep control of your boat.
- Always operate with courtesy and respect.
- Respect local regulations and practices.
- Near the shore, navigate in the designated boating areas and at low speed.
- At sea, weather conditions can rapidly deteriorate. Always be sure that you can reach a shelter rapidly.



BEWARE OF OFFSHORE WINDS AND CURRENTS!

**WARNING**

LIFE JACKETS: we recommend that life jackets be worn while underway and, without exception, by children and non-swimmers.

STOP SWITCH LANYARD: always attach the stop switch lanyard, preferably to your wrist, or failing that, on a fixed element of the garment you are wearing. Your outboard comes equipped with a stop switch safety lanyard to prevent a runaway boat in case the operator falls overboard.

NO ALCOHOL OR DRUGS: do not drink alcohol or take drugs before or while operating your boat. Maintain passenger sobriety.

Do not exceed the authorized number of passengers, power or weight.

MAKE SURE YOUR PASSENGERS are never seated at the front, with the legs **OUTSIDE THE BOAT:** Should they fall, the man overboard is in the path of the propeller.

ENSURE that passengers are in a safe position, avoid abrupt changes in course unless absolutely necessary.

Reduce the speed in waves for the comfort and safety of passengers.

In any case, warn the passengers before the manoeuvre.

AVOID SHARP TURNS AT HIGH SPEED: You would risk ejecting your passengers and yourself.

BE PARTICULARLY VIGILANT WHEN DOCKING: Arms or legs can be injured if they are outside the boat when manoeuvring.

KEEP CLEAR OF SWIMMERS AND DIVERS:

Always avoid areas where divers/swimmers are in the water. Keep a sharp lookout especially when operating near beaches and launch sites. Shut off the motor when operating near someone in the water.

The Alpha flag indicates the presence of divers in the area: it is imperative to stay clear of the area (at least 100 metres).

Never disembark without first having moored or anchored your boat.

OPERATING INSTRUCTIONS

SAFETY FIRST: Learn how to avoid accidents

RULES TO OBSERVE DURING NAVIGATION (cont'd)



WARNING

- BEWARE:** Avoid all contact between the buoyancy tube and sharp objects or aggressive liquids (such as acid).
- BATTERY:** Avoid sparks and open flames near battery (hydrogen gas from battery may explode).
- AVOID THE RISKS OF EXPLOSION OR FIRE HAZARDS:** Ensure your fuel system is in a good order and maintain it properly.
- AVOID SMOKING ON BOARD** and most particularly while filling the fuel tank.
- If fuel spills on the bottom of the boat, rinse with plenty of water.**

IN CASE OF ACCIDENT

In case of accident, do not panic, and reassure passengers. Be aware that the boat, even damaged, is often the best shelter and facilitates your rescue. Do not attempt to swim back to shore.

An inflatable boat is practically unsinkable, even when filled with water. If, after an accident, a compartment deflates, bring it back towards the inside of the boat, rebalance the load away from the deflated compartment and head back at reduced speed.

In the event of collision or impact with a floating object, stop to examine the bottom (the hull for RIBs), the floats, the engine and its mounting attachments before heading back at reduced speed.

Before your next outing, take your boat to your dealer for a rigorous inspection.





Neglecting inspections and repairs may lead to a serious injury and will reduce the life of your boat.

ENVIRONMENT

Responsible boating begins with you

With your inflatable boat, you can discover the richness of the marine environment. Help keep it beautiful. Enjoying some time on the water is great, but it comes with some responsibility for us all to work to ensure that the world around us remains a strong healthy environment for living and play. Please, respect your environment by applying the following basic safety rules:

	<ul style="list-style-type: none"> <input checked="" type="checkbox"/> Respect the life of marine animals. <input checked="" type="checkbox"/> Familiarize yourself with the international regulations governing pollution in the marine environment (MARPOL) and respect them as much as possible. <input checked="" type="checkbox"/> Keep up to date with local environmental regulations and follow the codes of practice. <input checked="" type="checkbox"/> If your boat is equipped with a toilet, do not discharge them or the contents of holding tanks near the coast or in prohibited areas. Instead, use the pumping system available in ports and marinas for this purpose. <input checked="" type="checkbox"/> Use non-polluting antifouling paint and non-polluting cleaning agents. <input checked="" type="checkbox"/> Keep out of designated swimming areas. <input checked="" type="checkbox"/> DON'T MAKE UNNECESSARY NOISE. Excessive noise and untimely exhaust emissions should be avoided. <input checked="" type="checkbox"/> Be careful not to overfill the fuel tank. Excess fuel collected in the holding tank must be carefully collected and disposed of in a suitable bin to prevent accidental discharge into the sea.
-----------------------------------------------------------------------------------	----------------------------------------------------------------------------------------------------------------------------------------------------------------------------------------------------------------------------------------------------------------------------------------------------------------------------------------------------------------------------------------------------------------------------------------------------------------------------------------------------------------------------------------------------------------------------------------------------------------------------------------------------------------------------------------------------------------------------------------------------------------------------------------------------------------------------------------------------------------------------------------------------------------------------------------------------------------------------------------------------------------------------------------------------------------------------------------------------------------------------------------------------------------------------------------------------------------------------------------------------------------------------------------------------------------------------------------------

	<ul style="list-style-type: none"> <input checked="" type="checkbox"/> Do not discharge hydrocarbons (oil or fuels) into the environment. <input checked="" type="checkbox"/> Do not litter. Dispose of your garbage and trash properly. If there is no appropriate refuse disposal, bring back your trash. <input checked="" type="checkbox"/> Do not make excessive wake. Remember that the wake your boat trails behind can be destructive to the shore, as well as to other boaters. A boat wake crashing on the shore can cause and accelerate erosion and damage the environment.
-------------------------------------------------------------------------------------	--------------------------------------------------------------------------------------------------------------------------------------------------------------------------------------------------------------------------------------------------------------------------------------------------------------------------------------------------------------------------------------------------------------------------------------------------------------------------------------------------------------------------------------------------------------------------------------------------------------------------

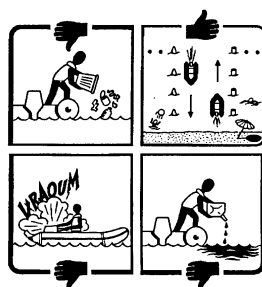

HANDLING

1. MOORING AND TOWING

1.1. MOORING

Fully inflatable boats: Use the buoyancy tube's lateral D-rings.

Rigid inflatable boats: Use the hull's mooring ring.

NOTE:	When moored, the self bailers should remain open to drain the rain water.
--------------	---------------------------------------------------------------------------

1.2. Towing

Fully inflatable boats should always be towed using a bridle; use the 2 lateral D-rings (fixed on the buoyancy tube) made for this purpose. For rigid inflatable boats (RIB), use a single line attached to the mooring ring.

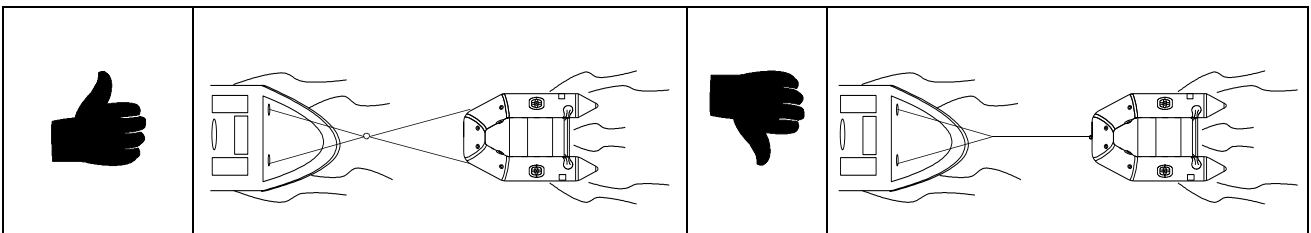

Towing fully inflatable boats:



Towing rigid inflatable boats:

Use the towing rings		
Unload the boat before towing (bags, fuel tank, outboard).		

NOTE:	Towing must be done at low speed and in good weather conditions.
--------------	------------------------------------------------------------------

 <p>WARNING</p>	<p>Anchor points showing visible signs of deterioration must be replaced. They must therefore be inspected regularly.</p>
 <p>WARNING</p>	<p>A towing cable must always be moored in such a way that it can be released under load.</p>
<p>NOTE:</p>	<p>Ensure that the mooring ropes, towing cables, chains, anchor lines and anchors are adequate for the boat's intended use, in particular that the lines or chains do not exceed 80% of the breaking strength of the corresponding anchor point (see Volume 2). If necessary, ask your Dealer to assist you.</p>

1.3 Mooring to a pontoon

The boat can be moored to a pontoon with at least two mooring lines: one fixed on the bow and one on the stern.

The mooring rope can be fastened on a fixed and strong point on the boat:

RIBS: Cleat, towing ring, mooring bitt, U-bolts (Do not use points not intended for this purpose: Bolt rope, handle, guard rail, handrail, D-rings, etc.)

- Foldable boats and tenders: Cleat, U-bolts, suspension brackets, bow handles (Do not use points not intended for this purpose: Boat rope, handle, small D-ring, etc.).



The boat must be protected from rubbing against the pontoon by fenders.

Mooring lines should not rub against the tube. Should the configuration not allow to avoid this, the buoyancy tube must be protected in areas of friction (Thick fabric or hose around the mooring rope, for example).

Any boat moored to a pontoon should be regularly watched and the mooring lines may need to be strengthened according to the weather conditions.

2. LIFTING - DAVITS

To hoist your boat and place it on davits, use the davit lifting rings provided for this purpose (see Volume 2) or have them installed by your dealer.

 WARNING	No passengers on board while hoisting
 CAUTION	<p>All equipment must be unloaded from the boat for lifting or davit handling.</p> <p>Self bailers should remain OPEN to drain the rain water.</p>

HANDLING

3. HAULING ON TRAILER

- The boat must be properly inflated.
- The self bailer should remain open.

3.1 Fully inflatable boats :

- Adjust the rollers (or supports) (1) of the trailer to fit the shape of the boat.
- Haul the boat onto the trailer using the lateral D rings.
- The bottom of the transom must rest on the trailer bunks.
- Place the motor in the down or trailing lock position so that it can rest on the support provided on the trailer (2).
- Check that the boat lies flat and is properly secured.
- Remove/secure all loose equipment.
- Tie down the straps and ensure the buoyancy tubes are protected against chafing (4).

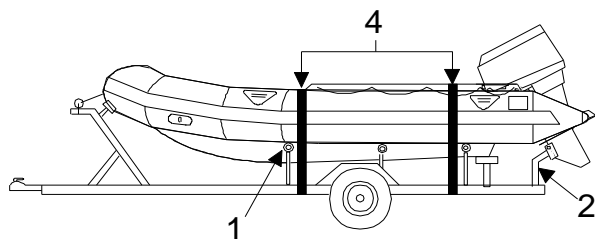

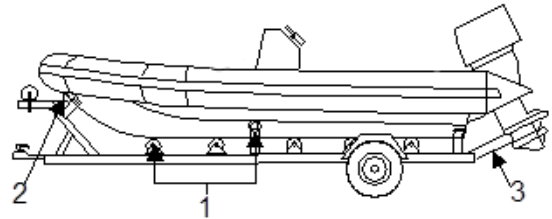

3.2 Rigid inflatable boats:

- Adjust the rollers in the central part so that the entire weight of the boat is resting on these rollers.
- Adjust the rollers or side blocks so as to stabilise the boat (be careful outside the strakes or steps).
- Check if the boat is stable.
- Place the motor in the down or trailing lock position so that it can rest on the support provided on the trailer (3).
- Use the towing rings and the bow ring (if so equipped) to secure the hull securely to the trailer.



- Every thing must be removed or secured to avoid flying away.
- Following the traffic rules you have to protect the propeller with a cover.

 CAUTION	<ul style="list-style-type: none"> • A BAD POSITION OF THE BOAT ON THE TRAILER MAY RESULT IN DAMAGE TO YOUR BOAT AND EQUIPMENT. • Never exceed the trailers' authorised weight capacity.
-------------------------------------------------------------------------------------------------------	--------------------------------------------------------------------------------------------------------------------------------------------------------------------------------------------------------------------------------

 WARNING	<p>ON THE ROAD:</p> <ul style="list-style-type: none"> • Boat must be empty of loose equipment when transported on trailer. • Nobody on board during transportation on trailer.
-------------------------------------------------------------------------------------------------------	------------------------------------------------------------------------------------------------------------------------------------------------------------------------------------------------------------------------------

MAINTENANCE

The buoyancy tube of your boat is made of fabric using plastomer. Maintenance is easy but essential for the longevity of your boat.

1. CLEANING

Clean your boat frequently, and imperatively before and after wintering.

It is essential to clean your boat regularly, especially the buoyancy tube. You can also entrust this task to your dealer, who has the products and experience necessary to perform a meticulous cleaning that will prolong the life of your boat.



**NEVER USE HIGH PRESSURE CLEANING EQUIPMENT
ON FABRIC ELEMENTS**

1.1 Cleaning the buoyancy tube

Buoyancy tube inflated:

- Open the self bailer and rinse the boat with a hose to remove sand and other debris.
- Regularly clean the buoyancy tube **with fresh water and soap**, at least monthly during periods of use.
- Remove all traces of tar (use the ACCESS product from your Dealer if required).
- Check the tube and high pressure air floor for leaks, with foamy soap and water.
- Rinse with fresh water and dry thoroughly.



No strong detergents (acid, trichlorethylene...), silicone-based products or like agents to be placed on tubes. If a spill occurs, wash off with water.

When deflating:

- Check that the valves and gaskets are clean and not damaged (sealing compound, sand, etc.).
- Check the self bailer is not clogged.

1.2 Check airtightness of your boat:

Note:	<p>Using the pressure indicator (supplied with some models or available from your dealer), measure the pressure loss after 24 hours.</p> <p>LOSS OF PRESSURE</p> <ul style="list-style-type: none"> • Loss of pressure (20%) over 24 hours is not unusual. <p>(ISO 6185 standard permits a certain amount of pressure loss). If loss of pressure exceeds:</p> <p style="padding-left: 40px;">0.145 PSI (0.010 Bar) / 5 hours for buoyancy tube</p> <p style="padding-left: 40px;">0.5 PSI (0.035 Bar) / 5 hours for high-pressure air-floor</p> <p>Check airtightness of your boat.</p> <ul style="list-style-type: none"> • Temperature has a great influence on air pressure. A variation of 1°C results in a variation in the same way of about +/- 4 mb (0.06 PSI). <p>If you have a problem with an air leakage: first, check all valves are intact and in closed position (nothing clogging valve). Do not hesitate to contact your Dealer.</p>
--------------	--------------------------------------------------------------------------------------------------------------------------------------------------------------------------------------------------------------------------------------------------------------------------------------------------------------------------------------------------------------------------------------------------------------------------------------------------------------------------------------------------------------------------------------------------------------------------------------------------------------------------------------------------------------------------------------------------------------------------------------------------------------------------------------------------------------------------------------------------------------------------------------------------------------------------------------------------------------------------------------------

1.3 For rigid inflatable boats: cleaning of the hull.

- Remove buoyancy tube (for boats with removable buoyancy tubes).
- Wash the deck and hull with soapy soap, rinse with fresh water and dry thoroughly.
- Check the self bailer is not clogged.
- Open the drainage holes caps to evacuate water.
- Reassemble the tube to the hull if necessary and inflate.

MAINTENANCE

1.4 Maintenance of stainless steel

We use only top quality stainless steels, which are resistant to corrosion. However, salt water is a harsh environment and maintenance is required to avoid corrosion.

NOTE:	<p>Stainless steel is not completely immune to corrosion and requires a minimum of care and maintenance:</p> <ul style="list-style-type: none"> • Avoid contamination that results of contact with tools made of ferrous metal: Use chromed tools. • Avoid scoring its surface. • Frequently wash with fresh water. • If necessary, regenerate the protective film with an appropriate product (ask your Dealer).
--------------	--------------------------------------------------------------------------------------------------------------------------------------------------------------------------------------------------------------------------------------------------------------------------------------------------------------------------------------------------------------------------------------------------------------------------------------------------------------------

1.5 Maintenance of the seats and marine plywood floor

Wash the seats and floor with soap and fresh water, and dry thoroughly.

Paints and varnishes not only are decorative elements, they also protect the materials. As soon as you see flakes or scratches on the surface, have it repainted using polyurethane - based products.

2. WINTERING - STORAGE

When storing your boat, keep it in a clean and dry place that is not affected from major variations in temperature and other damaging factors.

You may store the boat:

- Deflated and rolled up in its bag.
- Assembled and slightly inflated.

	<ul style="list-style-type: none"> • For long term storage in the sun (especially in tropical regions), protect your boat with a breathable canvass covering. • RODENTS CHEW ON FABRIC INCLUDING INFLATABLE BOAT MATERIAL. STORE AWAY FROM RODENTS. • IF YOU CHOOSE TO STORE YOUR BOAT INFLATED, MAKE SURE YOU DO NOT SUBJECT IT TO DEFORMATIONS.
-------------------------------------------------------------------------------------	---------------------------------------------------------------------------------------------------------------------------------------------------------------------------------------------------------------------------------------------------------------------------------------------------------------------------------------------------------------------------------------------------------

3. REGULAR INSPECTIONS

- Check frequently the signalling, straps and halyards. Replace used elements.
- Check frequently the tightness of the screws and nuts, particularly the motor's bolting to the transom.
- Regularly examine your fuel system, replace old or damaged elements. Check the tightness of the clamping rings.

MAINTENANCE

4. HOW TO REPAIR SMALL PUNCTURES

NOTE:	<p>Your boat is delivered with a repair kit which must be kept on board.</p> <p>Repairs performed while underway can be tricky. Observe the instructions below as far as possible. As soon as you return to shore, redo the repair or have it redone by your dealer.</p>
--------------	--------------------------------------------------------------------------------------------------------------------------------------------------------------------------------------------------------------------------------------------------------------------------

REPAIR KIT	<p>Cleaning :</p> <ul style="list-style-type: none"> ➤ Grease remover of the alcohol type (not supplied) <p>Repairing:</p> <ul style="list-style-type: none"> ➤ Patch. ➤ Tube of glue or repair patch (Patch'n Go) ➤ Brush (not supplied). ➤ Instruction sheet
CONDITIONS NECESSARY FOR SUCCESSFUL REPAIR	<ul style="list-style-type: none"> ➤ Relative humidity less than 60% ➤ Temperature between 18 and 25°C ➤ Avoid carrying out repairs in direct sunlight or in the rain ➤ Check that the buoyancy tube is fully deflated and lies flat
PREPARATION	<ul style="list-style-type: none"> ➤ Locate leaks (with soapy water if the leak is not visible to the eye) ➤ Cut out a round patch at least 5 cm beyond the tear in the buoyancy tube or use a suitable piece from the repair kit. ➤ Draw the shape of the patch exactly where it will be applied. ➤ Clean the damaged part of the boat and the corresponding side of the patch with a grease remover of the alcohol type ➤ Allow to dry for 5 minutes.
GLUING	<ul style="list-style-type: none"> ➤ Apply 3 thin layers of glue on both the patch and the roughened area on the boat and let dry for 3 to 5 minutes between each layer until tacky.

<p>PUTTING ON THE PATCH</p>	<ul style="list-style-type: none"> ➤ When the 3rd layer is dry, apply the patch without pressing and adjust the position, if required. ➤ Press out the air bubbles which may have formed under the patch. ➤ Smooth the patch with a round object (ex: a spoon) starting from the center of the patch. ➤ Clean the excess glue with a solvent.
<p>USE OF BOAT AFTER REPAIR</p>	<ul style="list-style-type: none"> ➤ Do not expose the repair to sun or rain. ➤ Let dry for 24 hours before inflating.
<div style="text-align: center;">  <p>WARNING</p> </div>	<ul style="list-style-type: none"> - Do not leave the tube in the sun or next to heat sources or direct flames. - Always work in a ventilated area, avoid inhaling glue vapors or swallowing it. Avoid contact with the skin or the eyes.

5. RIGID INFLATABLE BOATS: SMALL REPAIRS ON THE HULL

- The small scratches can be reduced or removed with polish or other appropriate products.
- The deeper scratches can be repaired with polyester mastic or repair gelcoat. In this case, ask your dealer.

<p>NOTE:</p>	<p>For major repairs, take your boat to a dealer who can perform after sales service.</p>
---------------------	-------------------------------------------------------------------------------------------

TROUBLESHOOTING GUIDE

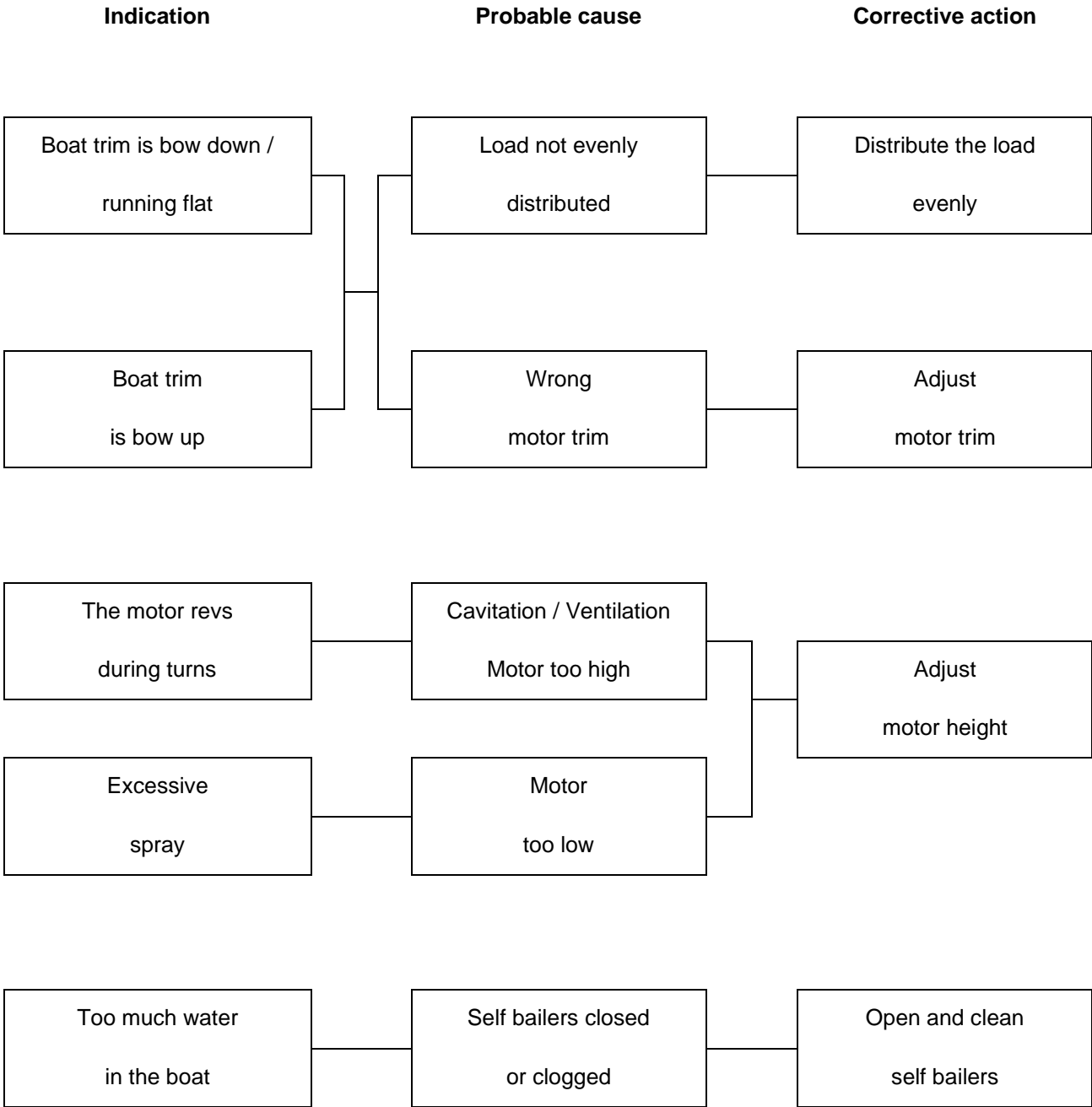

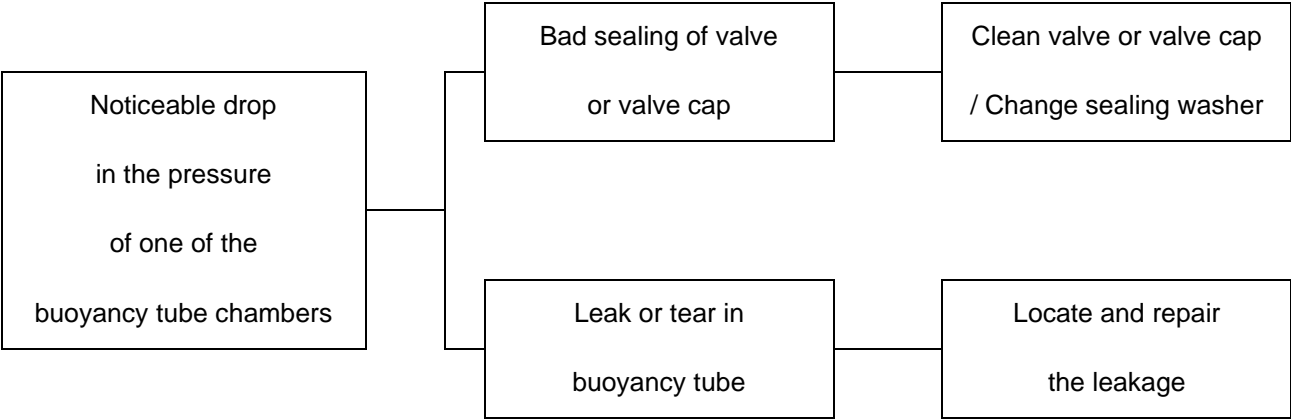
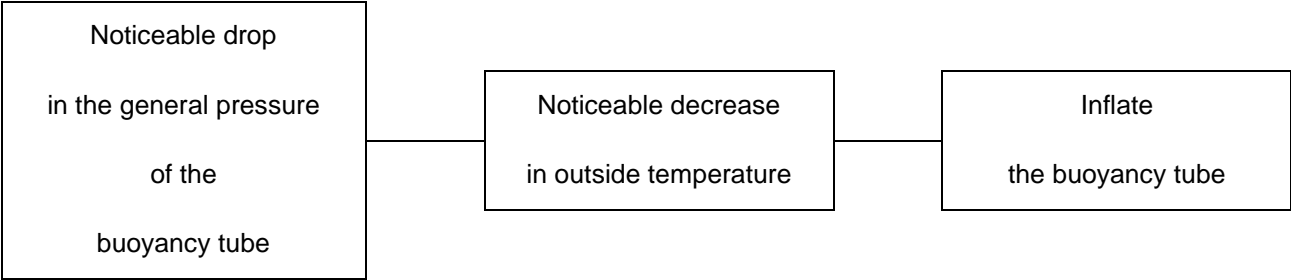

WARRANTY - GENERAL CONDITIONS

NOTE:	<p>Make sure your agent has registered your boat for the manufacturer's warranty. He will inform you about the warranty conditions.</p> <p>All warranty claims must also go through your agent.</p>
--------------	-------------------------------------------------------------------------------------------------------------------------------------------------------------------------------------------------------------------

The main limitations to the application of this warranty are the following :

- The boat must not be modified and/or fitted with a motor in excess of that allowable by the manufacturer or used in any activities outside normal recreational use (such as races, professional usage).
- Use in excess of the manufacturers recommended maximum load capacity.
- Pressure recommendations, assembly/disassembly and handling procedures must be strictly observed.
- The maintenance and the storage conditions must not be neglected.
- This warranty does not cover parts and accessories not supplied or recommended by the manufacturer or defects resulting from the installation of such equipment on their products.

 WARNING	<p>Your boat is designed in accordance with the standards for a specific use. Any modifications, transformations or use of a motor horse power higher than maximum allowable by the manufacturer could result in serious risks for the user and will void the warranty.</p>
-------------------------------------------------------------------------------------------------------	------------------------------------------------------------------------------------------------------------------------------------------------------------------------------------------------------------------------------------------------------------------------------------

NOTE:	<p>All repairs covered by warranty must be performed by an authorized dealer.</p>
--------------	------------------------------------------------------------------------------------------

Z NAUTIC
2 Chemin La Val Priout

31450 Ayguesvives

FRANCE

611957 - A

Eignerhandbuch

Teil 1 ALLGEMEINES - VORSICHTSMASSREGELN - SICHERHEIT

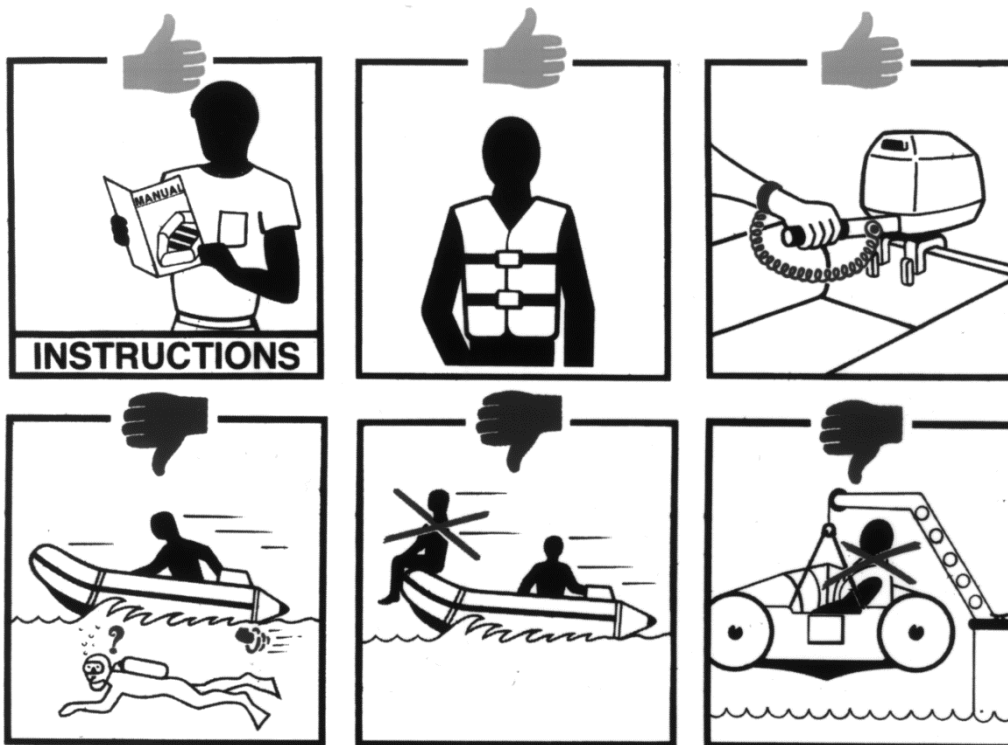

WARNUNG

- LESEN SIE DIESES HANDBUCH VOR DER INBETRIEBNAHME IHRES BOOTES AUFMERKSAM DURCH
- DAS EIGNERHANDBUCH IST IN 2 TEILE AUFGETEILT

<p>HINWEIS:</p>	<p>DAS EIGNER-HANDBUCH IST IN 2 TEILE AUFGETEILT:</p> <p>TEIL 1</p> <p>BEINHÄLTET DIE OPERATIVEN VORSICHTSMASSREGELN UND SICHERHEITSEMPFEHLUNGEN, DIE AN BORD UND AUF SEE ZU BEFOLGEN SIND.</p> <p>TEIL 2</p> <p>BEINHÄLTET DIE TECHNISCHEN SPEZIFIKATIONEN UND MONTAGEANLEITUNG FÜR DAS BOOT UND DESSEN AUSTRÜSTUNG.</p>
------------------------	------------------------------------------------------------------------------------------------------------------------------------------------------------------------------------------------------------------------------------------------------------------------------------------------------------------------------------------------

	<p>BOOTE BRINGEN SPASS UND WIR WOLLEN, DASS SIE DIESEN IN DEN KOMMENDEN JAHREN GENIESSEN KÖNNEN.</p> <p>NEHMEN SIE SICH DIE ZEIT UND LESEN SIE IHR EIGNER-HANDBUCH UND DIE SICHERHEITS- UND VORSICHTSMASSNAHMEN, UM DIE BEDEUTUNG DER BETRIEBS- UND SICHERHEITS-HINWEISE ZU VERSTEHEN.</p> <p>VERGESSEN SIE NIE: SICHERHEIT ZUERST.</p>
-------------------------------------------------------------------------------------	--------------------------------------------------------------------------------------------------------------------------------------------------------------------------------------------------------------------------------------------------------------------------------------------------------------------------------------------------------------

TEIL 1

ALLGEMEINES - VORSICHTSMASREGELN - SICHERHEIT



INHALT

	Seite		Seite
⇒ Sicherheitshinweise und -Symbole	2	⇒ Handhabung	
		1. Ankern - Schleppen	15
⇒ Wichtige Mitteilung – Vorbehalte	3	2. Davits	15
		3. Transport auf einem Trailer	16
⇒ Zulassung/Zertifizierung – Kennzeichnung	4		
⇒ Herstellerplakette	4-6	⇒ Instandhaltung und Pflege	
		1. Reinigung	17-18
⇒ Motor und Installation		2. Einwinterung - Lagerung	18
1. Motor	7	3. Regelmäßige Überprüfungen	18
2. Propeller	7	4. Ausführung kleinerer Reparaturen	19
3. Installation des Motors	8	5. GfK-Schlauchboote: Kleine Reparaturen	19
4. Anpassung	8-9	⇒ Fehlersuche und -behebung	20
⇒ Betriebshinweise	10-13	⇒ Garantie - Allgemeine Bedingungen	21
⇒ Umwelt	14	⇒ Weitere Informationen	22



SICHERHEITSHINWEISE - UND -SYMBOLE

In diesem Handbuch finden Sie Hinweise für den sicheren Umgang und Handhabung. Die nachfolgenden Symbole sind Hinweise, um auf besondere oder gefährliche Situationen aufmerksam zu machen. Sie sollten diese genau befolgen.

SICHERHEITSEMPFEHLUNGEN

 GEFAHR	<p>DIESES SYMBOL BEDEUTET, DASS EINE REALE UND EXTREME GEFAHRENQUELLE BESTEHT, DIE MIT HOHER WAHRSCHEINLICHKEIT ZUM TODE ODER ZU SCHWERSTEN VERLETZUNGEN MIT WAHRSCHEINLICH IRREPARABLEN SCHÄDEN VON PERSONEN FÜHREN KANN, FALLS DIESER HINWEIS NICHT ODER NUR TEILWEISE BEACHTET UND UMGESETZT WIRD.</p>
 WARNUNG	<p>Bedeutet, dass eine Gefahr besteht, die zu Verletzungen oder zum Tod führen kann, falls keine geeigneten Maßnahmen ergriffen werden.</p>
 ACHTUNG	<p>DIESES SYMBOL BEDEUTET EINE ERINNERUNG AN SICHERHEITSVORKEHRUNGEN ODER RICHTET DIE AUFMERKSAMKEIT AUF GEFÄHRLICHEN UMGANG UND HANDHABUNG, DIE ZU VERLETZUNGEN ODER ZU SCHÄDEN AN DEM WASSERFAHRZEUG ODER DESSEN BAUTEILEN FÜHREN KANN.</p>

ALLGEMEINE EMPFEHLUNGEN

	<p>DIESES VORGEHEN ODER VERHALTEN ENTSPRICHT DER BEDIENUNGSANLEITUNG.</p>
	<p>DIESES VORGEHEN ODER VERHALTEN ENTSPRICHT NICHT DER BEDIENUNGSANLEITUNG. ES BESTEHT DAS RISIKO DER BESCHÄDIGUNG VON BAUTEILEN UND AUSRÜSTUNG.</p>
HINWEIS:	<p>Macht auf wichtigen Informationen aufmerksam.</p>

WICHTIGE MITTEILUNG

Sie sind soeben Besitzer eines Schlauchboots oder GfK-Rumpf-Schlauchboots geworden, wir danken Ihnen für Ihr Vertrauen und empfehlen Ihnen, dieses Handbuch aufmerksam zu lesen.

Dieses Handbuch wurde zusammengestellt, damit Sie in der Lage sind, Ihr Wasserfahrzeug sicher, angenehm und mit Freude zu führen. Es enthält in Teil 2 neben Einzelheiten über das eigentliche Wasserfahrzeug, über mitgeliefertes oder montiertes Zubehör und über seine Systeme auch Informationen über Betrieb und Instandhaltung und Pflege. Sie sollten es sehr sorgfältig lesen und sich mit Ihrem Wasserfahrzeug vertraut machen, bevor Sie damit auf Fahrt gehen.

Der Steuermann ist für die einwandfreie Funktion des Bootes und für die Sicherheit der Fahrgäste verantwortlich. Sollte dieses Ihr erstes Wasserfahrzeug sein oder haben Sie gerade zu einem Ihnen nicht vertrauten Wasserfahrzeug gewechselt, achten Sie bitte zu Ihrer eigenen Sicherheit und Bequemlichkeit darauf, dass sichergestellt ist, dass Sie auch über ausreichende Kenntnisse und Fähigkeiten in Umgang und Betrieb haben, bevor Sie das Kommando an Bord übernehmen. Ihr Händler oder der nationale Segler- bzw. Motorboot-Verband wird Sie gern über örtliche Yachtschulen oder erfahrene Ausbilder informieren.

 ACHTUNG	<ul style="list-style-type: none"> • Bitte bewahren Sie das Handbuch an Bord an einem sicheren Ort auf, wo es jederzeit griffbereit für den Schiffsführer ist. • Es ist empfehlenswert, alle von den Herstellern des Zubehörs für das Boot (Motor, Batterie...) mitgelieferten Bedienungsanleitungen zusammen mit dem Handbuch aufzubewahren. • Dieses Handbuch ist Bestandteil der Standardausstattung. Bitte übergeben Sie es dem neuen Eigentümer, wenn Sie das Boot verkaufen.
-------------------------------------------------------------------------------------------------------	------------------------------------------------------------------------------------------------------------------------------------------------------------------------------------------------------------------------------------------------------------------------------------------------------------------------------------------------------------------------------------------------------------------------------------------------------------------------------------------------------------------------------------------

VORBEHALTE

Aufgrund unserer Verpflichtung, fortwährend auf dem Stand der neuesten Technologie zu sein, behalten wir uns das Recht vor, die Spezifikationen oder Lieferbarkeit unserer Bootsmodelle ohne vorherige Ankündigung zu ändern oder die Produktion einzustellen.

Die Informationen in diesem Handbuch betreffen das Boot zum Zeitpunkt der Veröffentlichung. Sie sind in keinem Fall Vertragsbestandteil.

HINWEIS:	Wir übernehmen keine Verantwortung für Konsequenzen aus Handlungen, die nicht in Übereinstimmung mit den in diesem Handbuch gegebenen Hinweisen stehen.
-----------------	----------------------------------------------------------------------------------------------------------------------------------------------------------------

ZULASSUNG/ZERTIFIKATION/KENNZEICHNUNG

Alle unsere Boote erfüllen die Anforderungen der ISO Norm 6185, wie sie von der ISO (International Standards Organization) festgelegt worden sind. Sie sind konform mit der Europäischen Richtlinie 2013/53/EU.

Wir sind ebenfalls Mitglied des US-Bootsherstellerverbands NMMA (National Marine Manufacturer's Association/USA), im Schiffbauverband FIN, im APER (Verein für umweltbewussten Bootssport), der es den Besitzern von in Frankreich eingetragenen Booten ermöglicht, diese nach Nutzungsende kostenlos zu zerlegen.

Übertragen Sie nachfolgend in die leeren Felder die entsprechenden Daten von der Hersteller-Plakette (Typenschild), die auf der Innenseite des Heckspiegels angebracht ist.

Diese Daten benötigen Sie im Fall eines Diebstahls für Ihre Versicherung oder für den Kundendienst (After-Sales-Service). Übertragen Sie sorgfältig die Modell und die Serien-Nummer Ihres Bootes, sowie die ID-Nummer.

① Herstellerplakette

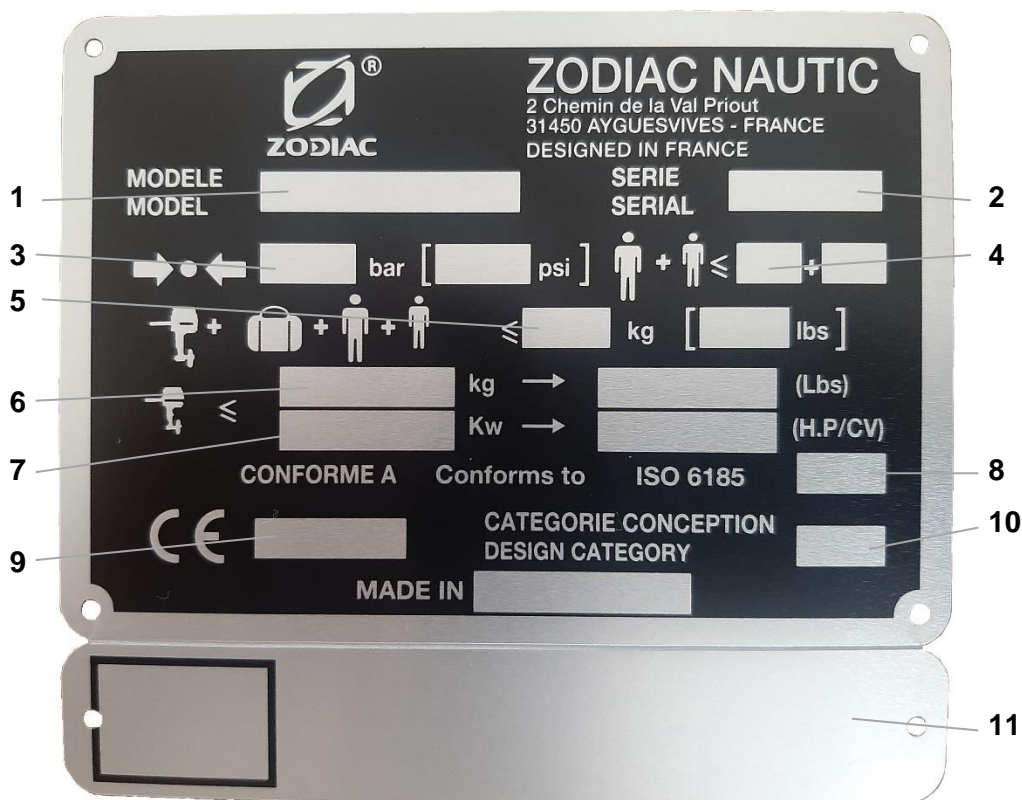

HERSTELLER-PLAKETTE

Die Angaben auf der Hersteller-Plakette auf dem Heckspiegel sind wichtige Informationen.

Die nachfolgenden Angaben stellen keine alles umfassende Liste dar, denn die Vorschriften können je nach Land und Staat, in dem Sie Ihr Boot fahren wollen, grundverschieden sein.

Unsere Angaben **stellen keine vollständige Liste der Anforderungen** beim Bootfahren dar (obligatorische Sicherheitsausrüstung des Boots, maximal erlaubte Entfernung von einem Schutzhafen, usw.), die je nach Land oder Staat unterschiedlich sein können. **Informieren Sie sich und beachten Sie immer die in dem jeweiligen Land, wo Sie fahren, geltenden gesetzlichen örtlichen und nationalen Vorschriften.**

- (1) **Modell:** Kommerzieller Modell-Name.
- (2) **Serien-Nummer:** kennzeichnet die Bootserie. Sie ist für alle Kundendienstvorgänge, für Zubehör und für Ersatzteilnummern wichtig .
- (3) **Betriebsdruck** des Schlauchkörpers in Bar und Psi. Bei anderen Teilen des Bootes können andere Betriebsdrücke gefordert sein. Siehe hierzu Eigner-Handbuch Band 2,, Kapitel AUFBLASEN oder die Angaben auf den Ventilen.
- (4) **Maximal zulässige Personenzahl** an Bord (Erwachsene + eventuell 1 Kind) bei Vorliegen einer angepassten Ausstattung gemäß den ISO-Normen.
- (5) Vom Hersteller **zugelassene maximale Gesamtladung** in kg und in lbs (Personen + Motor mit vollem Tank + Ausrüstung (Steuerstand, Sitze, Geräteträger) + verschiedene Lasten...), entsprechend der gültigen ISO-Norm 14945.
- (6) **Maximal** vom Hersteller **zugelassenes Gewicht des Außenbordmotors**, Wert in kg und Lbs (Pfund).
- (7) **Zulässige maximale Motorleistung** des Außenbordmotors für das Boot, Wert in kW und in PS.
- (8) **ISO Kategorie:**
Ihr Boot erfüllt die Anforderungen der Norm ISO CD 6185. Der Motorisierungsbereich ist wie folgt in Kategorien eingeteilt.

ISO KATEGORIE	II	V	VII
Motorisierungsbereich in kW	0 - 4.5 kW	4.5 - 15 kW	>15 kW
Motorisierungsbereich in PS	0 - 6 PS	6 - 20 PS	>20 PS

- (9) EU: Konformitätskennzeichnung entsprechend der Europäischen Direktive 2013/53/EU (ab einer Gesamtlänge von 2.50 m) gefolgt von der Nummer der zertifizierenden Institution (nur für Boote der Entwurfskategorie B)
- (10) **Entwurfskategorie (Europäische Direktive 2013/53/EU)** (ab einer Gesamtlänge von 2.50 m):
Innerhalb Europas ist Ihr Boot für den Einsatzbereich und einer bestimmungsgemäßen Verwendung der Auslegungskategorie B oder C oder D ausgelegt.

Kategorie	B	C	D
Fahrten	Außerhalb von Küstengewässern	„Küstennahe Gewässer“	"Geschützte Gewässer"
Windstärke (Beaufort)	bis einschließlich 8	bis einschließlich 6	bis einschließlich 4
Signifikante Wellenhöhe (m)*	bis einschließlich 4	bis einschließlich 2	bis einschließlich 0,5

**Sie stellt die mittlere Höhe des oberen Wellendrittels dar, was ungefähr der durch einen geübten Beobachter geschätzten Wellenhöhe entspricht. Manche Wellen werden doppelt so hoch wie dieser Wert sein.*

Einige unserer Boote sind für zwei Schiffahrtskategorien zugelassen. Um die vollständige Angabe der Eigenschaften bezüglich jeder Kategorie zu ermöglichen, verfügen sie über zwei verschiedene Herstellerplaketten.

- (11) **Die kleine Plakette**, welches im Allgemeinen auf der Außenseite des Heckspiegels im oberen Bereich befestigt ist und die ID-Nummer des Bootes enthält (CIN bzw. HIN).

 WARNUNG	<p>Seien Sie verantwortungsbewusst, beachten Sie insbesondere diese Parameter bei der Planung Ihrer Fahrten. Fahren Sie niemals los, wenn das Risiko der Überschreitung dieser Parameter besteht.</p>
-----------------------------------------------------------------------------------------------------	-------------------------------------------------------------------------------------------------------------------------------------------------------------------------------------------------------

MOTOR UND PROPELLER

1. MOTOR

1.1 Motorleistung

- Die zulässige und die empfohlene Motorleistung finden Sie in der Tabelle der Technischen Spezifikationen (TEIL 2 des Handbuchs).
- Bei kleinen Außenborder sind Motoren mit Pinnensteuerung zu bevorzugen.

Bei Motoren über 25 PS ist jedoch aus Gründen der Sicherheit und des Komforts eine Steuerkonsole zu empfehlen.

 WARNUNG	<p>Verwenden Sie niemals einen Motor mit einer höheren Leistung als der, die auf der Herstellerplakette angegeben ist. Sie würden gesetzwidrig handeln und könnten die Kontrolle über Ihr Boot verlieren.</p>
-------------------------------------------------------------------------------------------------------	----------------------------------------------------------------------------------------------------------------------------------------------------------------------------------------------------------------------

HINWEIS:	<p>Ist die zulässige Motorleistung größer als die maximal empfohlene Motorleistung, sollten Sie äußerst vorsichtig agieren. Sie ist für erfahrene Skipper gedacht, die ihre Boote für spezielle Zwecke einsetzen (Transport von schweren Lasten, usw.).</p> <p>Es ist empfehlenswert, dass Sie einen für Ihren überwiegenden Bootseinsatz passenden Motor wählen und dass Sie die empfohlene Motorleistung (siehe Band 2) berücksichtigen.</p> <p>Übermotorisiert kann Ihr Boot leicht aus der Kontrolle geraten. Untermotorisiert fehlt Ihnen vielleicht die notwendige Sicherheits-Leistungsreserve, um gegen Wind und/oder Strömungen sicher voranzukommen.</p>
-----------------	--------------------------------------------------------------------------------------------------------------------------------------------------------------------------------------------------------------------------------------------------------------------------------------------------------------------------------------------------------------------------------------------------------------------------------------------------------------------------------------------------------------------------------------------------------------------------------------------------------------------------------------------------------------------

1.2 Motorgewicht

Das Gewicht des Motors hat großen Einfluss auf die Übergangsphase von Verdränger- zur Gleitfahrt, Lagenstabilität und Fahreigenschaften eines Schlauchboots. Bei gleicher Motorleistung empfehlen wir, den leichteren Motor zu wählen.

Sie dürfen niemals das auf der Hersteller-Plakette angegebene zulässige Motorgewicht überschreiten.

1.3 Motor-Schaftlänge

Es gibt 4 verschiedene Motor-Schaftlängen: **S/L/XL/XXL**. Jedes Bootsmodell ist entweder für eine bestimmte Schaftlänge ausgelegt, die **nicht verändert werden kann**. Überprüfen Sie, für welche Schaftlänge Ihr Boot ausgelegt ist.

2. PROPELLER

- Um den optimalen Propeller für Ihre Einsatzart zu ermitteln, muss das Boot mit dem Motor im Wasser (auf See) getestet werden. Fragen Sie auch Ihren Händler.

- Grundsätzlich ist der mit dem Motor gelieferte Propeller für alle normalen Verwendungszwecke ausgelegt. Dennoch, abhängig von der besonderen Einsatzart wie Sie Ihr Boot einsetzen wollen, gilt folgendes:

Eine kleine Steigung ist zu wählen bei großer Zuladung und beim Einsatz für Wasserski.

Eine große Steigung erhöht die Geschwindigkeit (bei geringer Boots-Zuladung).

 GEFAHR	Jeglicher Kontakt mit dem drehenden Propeller kann schwere Verletzungen verursachen oder zum Tode führen. HALTEN SIE SICHERHEITSABSTAND ZUM PROPELLER.
-----------------------------------------------------------------------------------------------------	-----------------------------------------------------------------------------------------------------------------------------------------------------------------------------

INSTALLATION UND ANPASSUNG DES MOTORS

3. INSTALLATION DES MOTORS

- Installieren Sie den Motor in der Längsachse des Bootes, mittig auf der Motordruckplatte (4).
- Ziehen Sie die Klemmschrauben (1) von Hand so fest wie möglich und überprüfen Sie, ob diese auch nach 15 Minuten Motorbetrieb noch einwandfrei festgezogen sind.
- Für jegliche Motorverbolzung wenden Sie sich bitte an Ihren nächstgelegenen Händler.
- Sichern Sie den Motor mit dem Sicherungskabel (2) an der Öse (3) der Motordruckplatte (4).
- Alle Motoren über 4 PS sind mit einer Notstop-Schalter-Leine (5) ausgerüstet, die ein grundlegender Sicherheitsfaktor ist. Befestigen Sie diese immer an Ihrem Handgelenk (siehe Kapitel "Betriebshinweise" dieses Handbuchs).

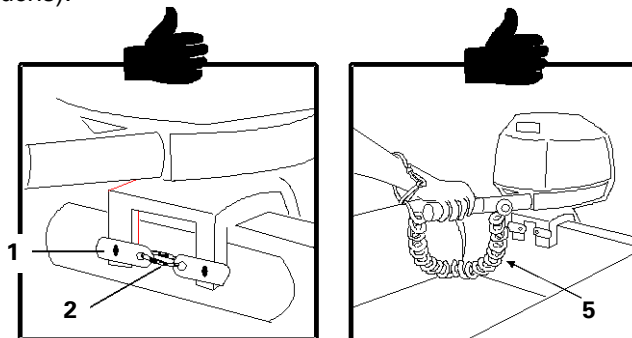
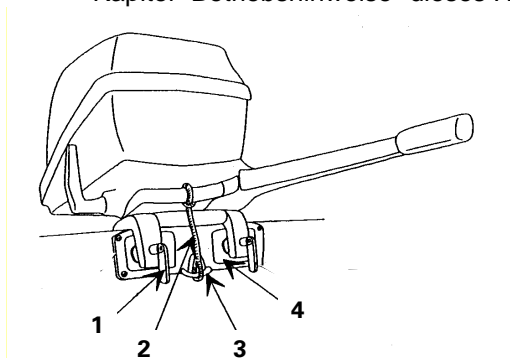

 ACHTUNG	<ul style="list-style-type: none"> • Ab 10 PS ist die Verbolzung des Motors empfehlenswert, ab 25 PS aufwärts ist ein Verbolzen unbedingt notwendig. • Ab 25 PS empfehlen wir die Verwendung einer Steuerkonsole.
--------------------	-------------------------------------------------------------------------------------------------------------------------------------------------------------------------------------------------------------------------------------------

 WARNUNG	<ul style="list-style-type: none"> • Bei nicht verschraubten Motoren die Klemmschrauben regelmäßig auf ihren Festsitz überprüfen. • Eventuell vorhandene Steuerkonsolen regelmäßig auf ihre Betriebssicherheit überprüfen.
--------------------	----------------------------------------------------------------------------------------------------------------------------------------------------------------------------------------------------------------------------------------------------

HINWEIS:	Prüfen Sie sorgfältig den festen Sitz der Mutter des Lenksystemanschlusses an den Motor. Lassen Sie den Motor von Ihrem Händler verbolzen.
-----------------	--------------------------------------------------------------------------------------------------------------------------------------------

4. ANPASSUNG

Der Motor muss auf zwei Positionen angepasst werden, in der Motorhöhe und in der Motoranstellung (Trim), die großen und unmittelbaren Einfluss auf das Bootsverhalten haben.

Die Motorhöhe muss nur einmal angepasst werden. Im Gegensatz dazu, muss - um Fahrverhalten und Manövrierbarkeit zu optimieren - der Angriffswinkel des Motors zum Heckspiegel jeweils in Abhängigkeit zu den Fahrtbedingungen angepasst werden:

4.1. Motorhöhe

Der Motor wird auf dem Heckspiegel aufliegend montiert. Je nach Motormarke kann selbst bei gleichem Schafttyp die Schaftlänge um wenige Zentimeter variieren. Manchmal ist es erforderlich, für die richtige Motorhöhe ein Ausgleichsstück zu unterlegen:

Motor sitzt zu hoch = der Motor kann Luft ziehen und überdrehen
 Motor sitzt zu tief = unpassendes Hochspritzen von Wasser

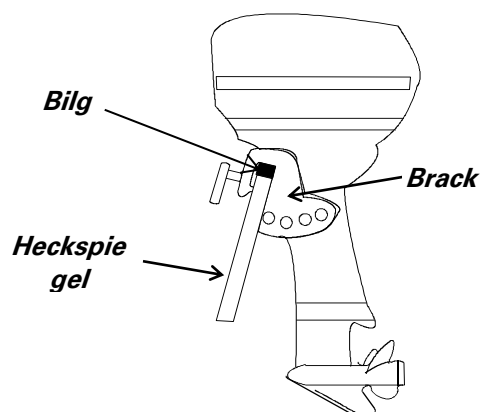

ANPASSUNG DES MOTORS



4.2 Motoranstellung (TRIM)

Als Regel gilt: der Motor sollte so angestellt sein, dass die Mittellinie der Propellerwelle parallel zur Wasseroberfläche verläuft.

Eine individuelle Anpassung des Anstellwinkels ist dennoch oftmals sehr empfehlenswert (siehe Kapitel "Betriebs-Hinweise").

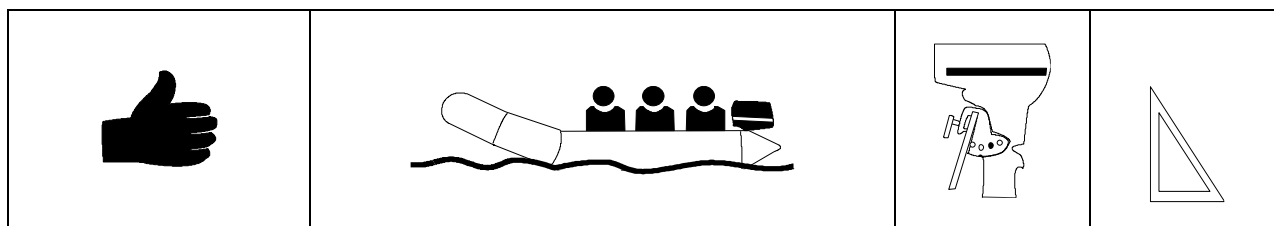
Die Anpassung des Anstellwinkels kann entweder manuell erfolgen oder durch die elektrische Trimmung (sofern der Motor damit ausgerüstet ist).

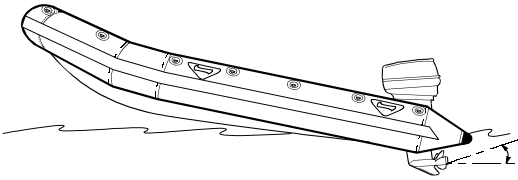
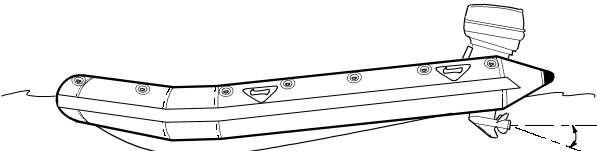

 	<p>Motorstellung zu weit weg vom Heckspiegel: das Boot neigt zum "Steigen".</p>  <p>Motorstellung zu nah am Heckspiegel: das Boot drückt den Bug nach unten.</p> 
------------------------------------------------------------------------------------------------------------------------------------------------------------------------	---------------------------------------------------------------------------------------------------------------------------------------------------------------------------------------------------------------------------------------------------------------------------------------------------------------------------------------

 WARNUNG	<p>Wenn die Anpassung des Anstellwinkels Ihres Motors manuell erfolgt, schalten Sie diesen vorher aus.</p>
-----------------------------------------------------------------------------------------------------	-------------------------------------------------------------------------------------------------------------------

HINWEIS:	<p>Spezielle, den Motor betreffende Informationen entnehmen Sie bitte dem Handbuch des Motorherstellers.</p>
-----------------	--------------------------------------------------------------------------------------------------------------

BETRIEBS - HINWEISE

Lastverteilung

- Verteilen Sie die Beladung möglichst gleichmäßig. (Beispiel: Befestigung des Tanks im vorderen Bereich kann das Motorgewicht im hinteren Bereich ausgleichen).
- Bei Pinnensteuerung sollte der Bootführer auf der Steuerbordseite stehen.

Beispiel für eine gute Lastverteilung:

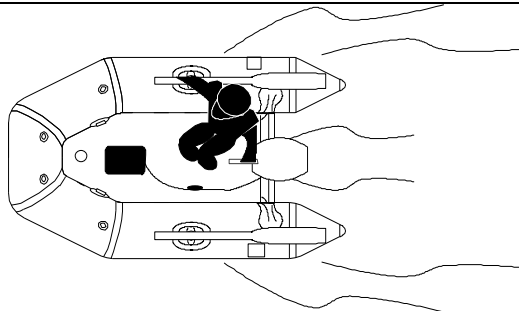

ACHTUNG

Eine schlechte Lastverteilung kann das Boot gefährlich destabilisieren, was den Kontrollverlust über das Boot bedingen kann.



ACHTUNG

Das Boot reagiert bei nur geringer Zuladung sehr sensibel. Seien Sie deshalb bei Beschleunigung oder bei Fahrtrichtungswechsel besonders vorsichtig.

Abhängig von den Fahrtbedingungen und der Wellenrichtung muss die Lastverteilung und die Trimmung angepasst werden:

gegen die See laufend

Last in den Bugbereich und bei Bedarf mit der Trimmstange den Motor einstellen.

Trimmstange in der 2. oder sogar der 1. Loch-Position arretieren

Negative TRIMMUNG

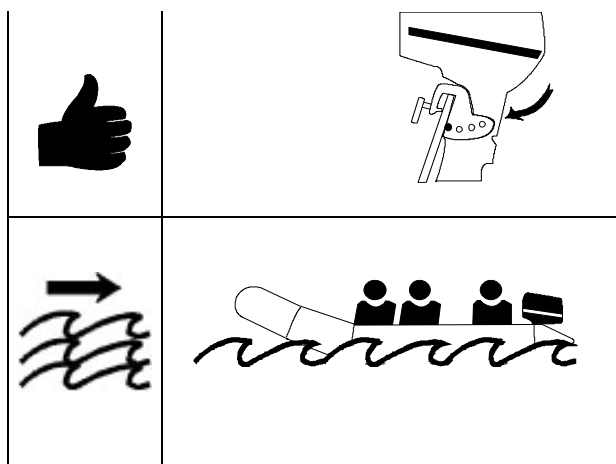



vor der See laufend

Last in den Heckbereich und bei Bedarf mit der Trimmstange den Motor einstellen.

Trimmstange in der 3. oder sogar der 4. Loch-Position arretieren

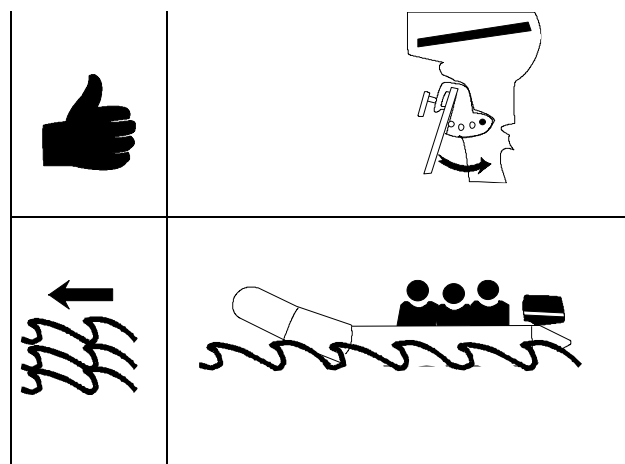
Positive TRIMMUNG



 ACHTUNG	<p>Das Boot nicht mit einer negativen Trimmung (niedriges Bug) bei hoher Geschwindigkeit fahren. Das Boot kann Schlagseite bekommen und in den Kurven instabil werden. Verwenden Sie eine negative Trimmung, um von der Fahrgeschwindigkeit zur Hydroplaning-Geschwindigkeit oder zu niedrigen Geschwindigkeiten im Kabelwasser überzugehen (wenn Ihr Motor über einen elektrischen Trimm verfügt).</p>
-------------------------------------------------------------------------------------------------------	---------------------------------------------------------------------------------------------------------------------------------------------------------------------------------------------------------------------------------------------------------------------------------------------------------------------------------------------------------------------------------------------------------

BETRIEBS - HINWEISE

SICHERHEIT AN 1. STELLE: LERNEN SIE, WIE MAN UNFÄLLE VERMEIDET.

CHECKLISTE VOR DEM ABLEGEN

 <p>WARNUNG</p>	<p>EINHOLEN DER ERFORDERLICHEN INFORMATIONEN UND HINWEISE AN IHRE PASSAGIERE:</p> <p><input checked="" type="checkbox"/> INFORMIEREN Sie sich über örtliche Vorschriften sowie über Gefahren hinsichtlich Wasseraktivitäten und Bootsbetrieb.</p> <p><input checked="" type="checkbox"/> PRÜFEN Sie Wetterbericht, örtliche Strömungen, Gezeiten-, Wasser- und Windverhältnisse.</p> <p><input checked="" type="checkbox"/> INFORMIEREN Sie eine Person an Land über Ihr Ziel und die geplante Zeit Ihrer Rückkehr.</p> <p><input checked="" type="checkbox"/> Lernen Sie, die Autonomie Ihres Bootes einzuschätzen: Die Entfernung, die Sie mit einem vollen Tank zurücklegen können, ist je nach Zustand des Meeres sehr unterschiedlich. Stellen Sie sicher, dass Ihre Tankfüllung immer ausreicht, einen Schutzhafen anzulaufen.</p> <p><input checked="" type="checkbox"/> ERKLÄREN Sie allen Passagieren die grundlegenden Fahrvorgänge.</p> <p><input checked="" type="checkbox"/> STELLEN SIE SICHER, dass einer der Passagiere im Notfall das Steuer übernehmen kann.</p>
---------------------------------------------------------------------------------------------------------	-------------------------------------------------------------------------------------------------------------------------------------------------------------------------------------------------------------------------------------------------------------------------------------------------------------------------------------------------------------------------------------------------------------------------------------------------------------------------------------------------------------------------------------------------------------------------------------------------------------------------------------------------------------------------------------------------------------------------------------------------------------------------------------------------------------------------------------------------------------------------------------------------------------------------------------------------------------------------------------------------------------------------------------------------------------------------------------------------------------------------------------

	<p style="text-align: center;">Überprüfen Sie die Funktionsfähigkeit der Ausrüstung je nach Zustand des Meeres und der Verwendung.</p> <p><input checked="" type="checkbox"/> ÜBERPRÜFEN Sie den Druck des Schlauchkörpers.</p> <p><input checked="" type="checkbox"/> ÜBERPRÜFEN Sie die Lenzventile: Entfernen Sie die Stopfen der Lenzschläuche und überprüfen Sie den Verschluss der Rumpf-Lenzventile.</p> <p><input checked="" type="checkbox"/> VERGEWISSERN Sie sich, dass die Notstoppleine korrekt funktioniert.</p> <p><input checked="" type="checkbox"/> ÜBERPRÜFEN SIE die korrekte Befestigung des Motors am Heckspiegel.</p> <p><input checked="" type="checkbox"/> ÜBERPRÜFEN UND REINIGEN SIE den eventuell vorhandenen Benzinfilter.</p> <p><input checked="" type="checkbox"/> ÜBERPRÜFEN SIE die verfügbare Benzinmenge.</p> <p><input checked="" type="checkbox"/> VERGESSEN SIE NICHT, Öl nachzufüllen, falls Ihr Motor einen separaten Öltank hat.</p> <p><input checked="" type="checkbox"/> BEFESTIGEN Sie Ihren Kraftstofftank an dem dafür vorgesehenen Platz. Kontrollieren Sie die korrekte Befestigung aller mobilen Bestandteile.</p> <p><input checked="" type="checkbox"/> ÜBERZEUGEN Sie sich, dass der Motor in Position NEUTRAL steht, bevor Sie ihn starten.</p>
	<p style="text-align: center;">SICHERHEITS-AUSRÜSTUNG: (Prüfen Sie Gesetze und Vorschriften des Landes oder der Region Ihres jeweiligen Fahrtgebietes).</p> <p><input checked="" type="checkbox"/> Eine Rettungsweste pro Person an Bord, die an die Morphologie der betreffenden Person und die Gegend angepasst ist.</p> <p><input checked="" type="checkbox"/> Fußblasebalm, Paddel (oder Ruder), Reparatursatz und Werkzeugsatz.</p> <p><input checked="" type="checkbox"/> Die vorgeschriebene Notausrüstung.</p> <p><input checked="" type="checkbox"/> Die Bootspapiere und Ihr Bootsführerschein.</p> <p><input checked="" type="checkbox"/> Eine elektrische Lampe, zusätzlich zu den vorgeschriebenen Positionsleuchten bei Fahrten ab Einbruch der Dunkelheit.</p>

BETRIEBS - HINWEISE**SICHERHEIT AN 1. STELLE: LERNEN SIE, WIE MAN UNFÄLLE VERMEIDET.****REGELN, DIE FÜR DEN FAHRBETRIEB BEACHTET WERDEN MÜSSEN.**

- Seien Sie verantwortungsbewusst: vernachlässigen Sie nicht die Sicherheitsregeln, Sie würden Ihr Leben und das Leben anderer Menschen gefährden.
- Beachten Sie die Vorfahrtregeln, die durch die Kollisionsverhütungsregeln der COLREG (Internationale Regeln zur Verhütung von Zusammenstößen auf See) definiert und vorgeschrieben wurden.
- Achten Sie darauf, immer über einen genügenden Abstand zu verfügen, um gegebenenfalls stoppen oder ausweichen zu können und einen Zusammenstoß zu vermeiden.
- Fahren Sie in Bereichen mit viel Verkehr, bei schlechten Sichtverhältnissen, starkem Wind oder hohen Wellen nicht mit maximaler Geschwindigkeit.
- Reduzieren Sie aus Höflichkeit und aus Sicherheitsgründen für Sie selbst und die Anderen die Geschwindigkeit und Ihr Kielwasser. Respektieren Sie die Bereiche mit Geschwindigkeits- und Kielwasserbeschränkungen.
- Lernen Sie, Ihr Boot zu jeder Zeit zu beherrschen und sein Sie beim Fahren permanent aufmerksam.
- Handeln Sie immer höflich und mit Respekt.
- Respektieren Sie die örtlichen Vorschriften und Praktiken.
- Fahren Sie in Strandnähe langsam und ausschließlich in den gekennzeichneten Fahrtbereichen.
- Auf See können sich die Wetterverhältnisse sehr schnell verändern. Stellen Sie sicher, dass Sie schnell genug einen Schutzhafen erreichen können.

 ACHTUNG	VORSICHT BEI WIND UND STRÖMUNGEN, DIE AUF DAS MEER HINAUSTREIBEN!
-------------------------------------------------------------------------------------------------------	--------------------------------------------------------------------------



WARNUNG

RETTUNGSWESTEN: Wir empfehlen das Tragen von Rettungswesten während der Fahrt, und in jedem Fall für Kinder und Nichtschwimmer.

LEGEN SIE IMMER DIE NOTSTOPPLEINE AN : Befestigen Sie die Leine am besten an Ihrem Handgelenk oder an einem sonstigen festen Bestandteil der Kleidung, die Sie tragen. Ergreifen Sie sämtliche Vorsichtsmaßnahmen, um ein ungewolltes Starten des Batterieschalters zu vermeiden, denn dadurch könnte ein gefährlicher Kontrollverlust beim Manövrieren resultieren.

KEIN ALKOHOL/KEINE DROGEN: Führen Sie nie ein Boot unter Einfluss von Alkohol oder Drogen. Achten Sie darauf, dass die Passagiere nüchtern sind.

ÜBERSCHREITEN SIE NICHT DIE ZULÄSSIGE PERSONENZAHL, ZULADUNG ODER MOTORLEISTUNG.

ACHTEN SIE DARAUF, DASS IHRE PASSAGIERE NIEMALS VORN AUF DEM BOOT MIT DEN BEINEN AUßENBORDES SITZEN: Ein Mann über Bord fällt direkt in die Propellertrasse.

ACHTEN SIE DARAUF, dass die Passagiere sicher installiert sind, vermeiden Sie plötzliche Richtungswechsel, außer wenn diese unbedingt erforderlich sind.

Reduzieren Sie bei Wellengang zur Sicherheit und für den Komfort aller Beteiligten die Geschwindigkeit.

Informieren Sie in jedem Fall die Passagiere über Fahrtrichtungswechsel.

VERMEIDEN SIE SCHARFE KURVEN BEI HOHER GESCHWINDIGKEIT: Sie und Ihre Passagiere könnten über Bord katapultiert werden.

SEIN SIE BESONDERS VORSICHTIG BEIM ANLEGEN. Arme und Beine können verletzt werden, wenn diese beim Manövrieren außenbords sind.

VERGESSEN SIE NICHT, DASS DER PROPELLER FÜR SCHWIMMER UND TAUCHER GEFÄHRLICH IST:

Erlauben Sie Ihren Passagieren kein Baden bei laufendem Motor und halten Sie besonders intensiv Ausschau, wenn Sie in Strandnähe fahren.

Die Alpha-Flagge zeigt die Nähe von Tauchern an. Sie **MÜSSEN** klar Abstand halten (Minimum 100 Meter).

Niemals vor Ankern oder Festmachen Ihres Bootes von Bord gehen.

BETRIEBSHINWEISE

SICHERHEIT AN 1. STELLE: LERNEN SIE, WIE MAN UNFÄLLE VERMEIDET.

REGELN, DIE FÜR DEN FAHRBETRIEB BEACHTET WERDEN MÜSSEN (FORTSETZUNG)

**WARNUNG**

- SEIN SIE VORSICHTIG: VERMEIDEN SIE jeden Kontakt des Schlauchkörpers mit scharfen Gegenständen oder aggressiven Flüssigkeiten (z.B. Säuren).**

- ACHTUNG AUF DIE BATTERIE: Hüten Sie sich vor Stromschlägen und vor der enthaltenen Säure.**

- VERMEIDEN SIE RISIKEN EINER EXPLOSIONS- ODER FEUERGEFAHR: Stellen Sie sicher, dass Ihr Kraftstoffsystem in funktionsfähigem und guten Zustand ist.**

- RAUCHEN SIE NIEMALS BEIM TANKEN.**

- SOLLTE KRAFTSTOFF AUF DEN BODEN VERSCHÜTTET WORDEN SEIN: waschen Sie diesen mit viel Wasser weg.**

IM FALLE EINES UNFALLES

Im Falle eines Unfalls geraten Sie nicht in Panik, sondern beruhigen Sie die Passagiere. Sein Sie sich bewusst, dass das Boot, selbst wenn es beschädigt sein sollte, oftmals die beste Zuflucht bleibt und erst die Ortung Ihrer Position ermöglicht. Versuchen Sie nicht, das Ufer schwimmend zu erreichen.

Ein Schlauchboot ist praktisch unsinkbar, selbst wenn es voll Wasser ist. Falls nach einem Unfall eine Luftkammer leer ist, ziehen Sie sie ins Boot, verlagern Sie die Beladung auf die der leeren Kammer entgegengesetzten Seite und fahren Sie mit reduzierter Geschwindigkeit zurück.

Im Falle einer Kollision mit einem schwimmenden Gegenstand stoppen Sie, um den Rumpf, den Schlauchkörper, den Motor und seine Anschlüsse zu kontrollieren, und fahren Sie dann mit geringer Fahrt zurück zum Land.

Bringen Sie Ihr Boot unverzüglich zu Ihrem Händler, bevor Sie es wieder einsetzen.





VERNACHLÄSSIGUNG VON INSPEKTIONEN UND REPARATUREN KANN DIE LEBENSDAUER IHRES BOOTES VERKÜRZEN UND GEFAHREN BEDINGEN.

UMWELT

VERANTWORTUNGSBEWUSSTES BOATING BEGINNT MIT IHNEN

Mit Ihrem Schlauchboot können Sie die reiche Vielfalt der maritimen Umwelt entdecken. Respektieren Sie Ihre Umwelt, indem Sie die folgenden Grundregeln befolgen:

	<ul style="list-style-type: none"> <input checked="" type="checkbox"/> RESPEKTIEREN SIE DIE MEERESTIERWELT. <input checked="" type="checkbox"/> Informieren Sie sich bezüglich der internationalen Vorschriften bezüglich der Meeresumweltverschmutzung (MARPOL) und halten Sie sich so gut wie möglich an diese Vorgaben. <input checked="" type="checkbox"/> Informieren Sie sich bezüglich der örtlichen Vorschriften bezüglich des Umweltschutzes und halten Sie sich an die bewährten Praktiken. <input checked="" type="checkbox"/> Wenn Ihr Boot über Toiletten verfügt, entleeren Sie diese oder den Inhalt der Fäkalientanks nicht in Küstennähe oder in verbotenen Zonen. Nutzen Sie hierfür die Entsorgungssysteme in Häfen oder Marinas <input checked="" type="checkbox"/> VERWENDEN SIE UMWELTFREUNDLICHE FARBEN (ANTIFOULINGS) UND REINIGUNGSMITTEL. <input checked="" type="checkbox"/> HALTEN SIE ABSTAND VON AUSGEWIESENEN BADEZONEN. <input checked="" type="checkbox"/> Beschränken Sie Lärm: Respektieren Sie die Anderen, vermeiden Sie übermäßigen Lärm und unpassende Abgasemissionen. <input checked="" type="checkbox"/> Sein Sie beim Befüllen des Kraftstofftanks vorsichtig. Der im Auffangbecken angesammelte überschüssige Kraftstoff muss sorgfältig aufgewischt und in einem passenden Müllbehälter entsorgt werden, um jegliches versehentliche Freisetzen im Meer zu vermeiden.
	<ul style="list-style-type: none"> <input checked="" type="checkbox"/> ENTLEEREN SIE KEIN ÖL ODER KRAFTSTOFF IN DIE FREIE NATUR. <input checked="" type="checkbox"/> Abfälle und Müllsäcke dürfen nicht im Wasser entsorgt werden. <input checked="" type="checkbox"/> VERMEIDEN SIE BELÄSTIGENDE HECKWELLEN UND KIELWASSER FÜR DIE ANRAINER.

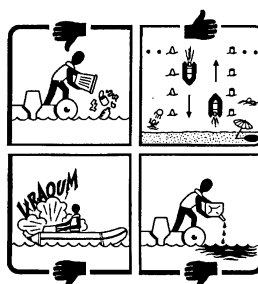

HANDHABUNG

1. ANKERN UND SCHLEPPEN

1.1 ANKERN

Schlauchboot : Benutzen Sie die lateralen D-Ringe.

GfK-Rumpf-Schlauchboot : Benutzen Sie den Bugring am Rumpf.

HINWEIS:	Vor Anker sollten die Lenzventile offen sein, damit das Regenwasser gelenzt werden kann.
-----------------	------------------------------------------------------------------------------------------



1.2 SCHLEPPEN

Schlauchboote sollten immer über ein Schlepp-V, das in die dafür vorgesehenen 2 lateralen D-Ringe (Besätze am Schlauchkörper) eingeschäkelt wird, geschleppt werden. GfK-Rumpf-Schlauchboote werden mit einer am Bugring festgemachten Zugleine geschleppt.

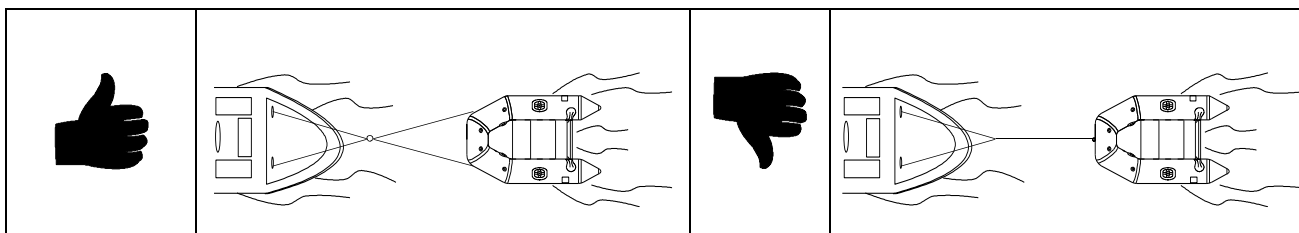

Schleppen des Schlauchbootes:

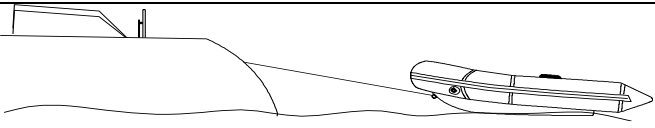

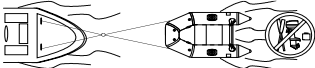
Schleppen von GfK-Rumpf-Schlauchbooten:

Verwenden Sie den Bugring		
Entladen Sie das Boot vor dem Abschleppen (Taschen, Kraftstofftank, Außenbordmotor, Ruder).		

HINWEIS:	Der Schleppvorgang sollte nur bei niedriger Geschwindigkeit und bei guten Wetterbedingungen (ruhiges Meer, schwacher Wind) erfolgen.
-----------------	--------------------------------------------------------------------------------------------------------------------------------------

 ACHTUNG	<p>Die Verankerungspunkte, welche sichtbar beschädigt sind, sollten ersetzt werden. Sie sollten deshalb regelmäßig kontrolliert werden.</p>
 ACHTUNG	<p>Ein Schleppkabel sollte immer derart befestigt werden, dass es unter Last gelöst werden kann.</p>
HINWEIS:	<p>Vergewissern Sie sich, dass die Seile zum Festmachen, die Schleppkabel, die Ankerketten, Ankertaus sowie die Anker für die beabsichtigte Nutzung des Bootes passen, insbesondere, dass die Taue und Ketten nicht 80 % der Bruchfestigkeit des betreffenden Verankerungspunkts übersteigen (siehe Band 2). Fragen Sie bei Bedarf Ihren Händler um Rat.</p>

1.3 Festmachen an einem Bootsanleger

Das Boot kann mit Hilfe von mindestens zwei Haltetauen an einem Bootsanleger festgemacht werden: ein Tau am Bug, eins am Heck.

Das Tau kann an einem fixen und ausreichend soliden Punkt des Bootes festgemacht werden:

- GfK-Rumpf-Schlauchboote: Klampe, Bugöse, Tauhalter, Hebe­punkte am Heck­spiegel (die nicht zu diesem Zweck vorgesehenen Punkte wie Keder, Griffe, Bugkorb, Handläufe, D-Ringe,... dürfen nicht benutzt werden).

- Faltbare Boote und Tender: Klampe, Hebe­punkte am Heck­spiegel, Schleppring, Bug-Tragegriff (die nicht zu diesem Zweck vorgesehenen Punkte wie Keder, Griffe, D-Ringe, ... dürfen nicht benutzt werden).



Das Boot muss unter allen Umständen vor Scheuern am Boots­anleger durch Fender geschützt werden.

Die Taue dürfen nicht am Schlauch scheuern. Wenn dies an dem vorhandenen Boots­anleger nicht vermeidbar ist, so ist der Schlauch an den Scheuerstellen zu schützen (z.B. durch dickes Tuch oder das Tau durch ein Stück Gartenschlauch schieben).

Jedes an einem Boots­anleger festgemachte Boot muss regelmäßig überwacht werden und das Tau je nach meteorologischen Konditionen eventuell verstärkt werden.

2. DAVITS

Um Ihr Boot in die Davits zu hieven und zu verlaschen, verwenden Sie die Davit-Hubösen (siehe Band 2) oder lassen Sie diese von Ihrem Händler installieren, wenn Ihr Schlauchboot nicht damit ausgerüstet sein sollte.

 WARNUNG	WÄHREND DES HIEV-VORGANGS DARF NIEMAND AN BORD SEIN.
 VORSICHT	<p>Beim Heben bzw. Davitaufhängen MUSS das Boot KOMPLETT AUSGELADEN sein.</p> <p>Die Lenzventile müssen geöffnet bleiben und das Boot zum Heck hin leicht abwärts geneigt sein, um eventuelles Wasser lenzen zu können.</p>

HANDHABUNG

3. TRANSPORT AUF EINEM TRAILER

- Das Boot muss voll aufgeblasen sein.
- Die Lenzventile müssen geöffnet bleiben.

3.1 Schlauchboote:

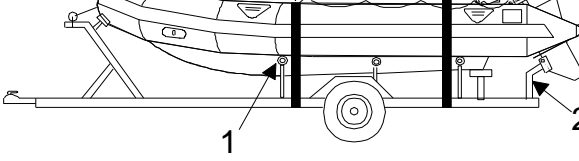
- Stellen Sie die Stützrollen (1) des Trailers so ein, dass sie die Schlauchkörper auf beiden Seiten und am Heck stützen.
 - Ziehen Sie das Boot von vorne mit den lateralen D-Ringen auf den Trailer.
 - Der Heckspiegel muss auf den Stützen des Trailers aufliegen.
- 
- Stellen Sie den Motor in senkrechte Position oder in Trailer-Position, so dass der Motor am Anhänger (2) anliegt.
 - Vergewissern Sie sich, dass das Boot gut befestigt ist und flach aufliegt.
 - Entfernen Sie sämtliches Material, das wegfliegen könnte.
 - Sichern Sie bei Bedarf das Aufliegen des Boots durch Unterlegestützen und ziehen Sie die Gurte fest. Zum Scheuerschutz für die Schlauchkörper Zwischenlagen einfügen (4).

3.2 GfK-Rumpf-Schlauchboote:

- Stellen Sie die Stützrollen-des mittleren Bootteils so ein, dass das gesamte Bootgewicht auf ihnen ruht.
- Stellen Sie die Stützrollen oder die Seitenführungen so ein, dass das Boot stabilisiert wird (Achtung auf die Planken oder Vertiefungen).
- Stellen Sie den Abstand zum Griff der Anhängerkupplung so ein, dass der Heckspiegel auf der letzten mittleren Stützrolle aufliegt.
- Stellen Sie den Motor in senkrechte Position oder in Trailer-Position, so dass er passend auf dem Anhänger (3) anliegt.
- Nutzen Sie die Schleppringe und - soweit vorhanden - den Bugring, um den Rumpf solide auf dem Anhänger zu befestigen.

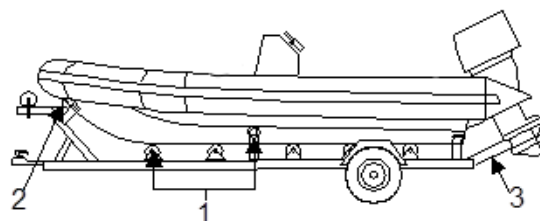

Entfernen oder befestigen Sie das Material, welches wegfliegen kann, inklusive das Zubehör und abnehmbare Bestandteile.

Achten Sie darauf, dass der Schlauchkörper gegen Scheuern gesichert ist.

 ACHTUNG	<ul style="list-style-type: none"> • BEI EINEM AUF DEM TRAILER SCHLECHT AUFLIEGENDEN BOOT KÖNNEN IRREPARABLE SCHÄDEN AUFTRETEN, DIE FUNKTIONSTÖRUNGEN NACH SICH ZIEHEN KÖNNEN. • Überschreiten Sie niemals das zulässige Gesamtgewicht des Trailers
-------------------------------------------------------------------------------------------------------	-------------------------------------------------------------------------------------------------------------------------------------------------------------------------------------------------------------------------------------------------------------------------------------------

 WARNUNG	<p>WÄHREND DES TRANSPORTS:</p> <ul style="list-style-type: none"> • Während des Trailer-Transports darf keine lose Ausrüstung im Boot sein. • Während des Trailer-Transports darf sich niemand an Bord des Bootes befinden.
-------------------------------------------------------------------------------------------------------	--------------------------------------------------------------------------------------------------------------------------------------------------------------------------------------------------------------------------------------------------------------------------

INSTANDHALTUNG UND PFLEGE

Der Schlauchkörper Ihres Bootes hat eine Bootshaut aus unverrottbarem Plastomer. Instandhaltung und Pflege ist problemlos aber sehr wichtig für die Lebenserwartung Ihres Bootes.

1. REINIGUNG

Reinigen Sie oft Ihr Boot, vor allem und unbedingt vor und nach der Einwinterung.

Es ist grundsätzlich wichtig, das Boot regelmäßig zu reinigen, insbesondere den Schlauchkörper. Sie können diese Aufgabe auch Ihrem Händler anvertrauen, der über die entsprechenden Produkte und die nötige Erfahrung verfügt, um eine gewissenhafte Reinigung durchzuführen, die die Lebensdauer Ihres Bootes verlängern wird.



**VERWENDEN SIE NIEMALS EIN
HOCHDRUCKREINIGUNGSGERÄT AUF DER BOOTSHAUT.**

1.1 Reinigung des Schlauchkörpers

Aufgeblasener Schlauchkörper:

- Öffnen Sie die Lenzventile und waschen Sie das Boot mit dem Wasserschlauch aus und entfernen so Sand und andere Partikel.
- Reinigen Sie regelmäßig den Schlauchkörper mit Seife und **frischem Wasser**, mindestens einmal pro Monat während des Nutzungszeitraums.
- Entfernen Sie alle Spuren von Teer (verwenden Sie bei hartnäckigen Flecken das bei Ihrem-Händler verfügbare Produkt).
- Prüfen Sie Schlauchkörper mit schaumigem Seifenwasser auf Leckagen.
- Spülen Sie mit frischem Wasser nach und lassen Sie das Boot trocknen.



Verwenden Sie niemals starke Reinigungsmittel (Säure, Trichloräthylen, Benzin) oder auf Silikon basierende Produkte. Sollten dennoch derartige Produkte verschüttet worden sein, waschen Sie diese mit viel Wasser ab.

Entlüften des Schlauchkörpers

- Prüfen Sie die Ventile, ob die Membranen und Dichtungen nicht beschädigt sind (Leckagen, Sand, usw.).
- Prüfen Sie, ob die Lenzventile nicht verstopft sind.

1.2 Prüfen Sie die Luftdichtigkeit Ihres Schlauchkörpers:

HINWEIS:	<p><i>Dank dem Manometer</i> (bei manchen Modellen im Zubehör oder sonst bei Ihrem Händler verfügbar) können Sie den Druckverlust innerhalb von 24 Stunden messen.</p> <p>DRUCKVERLUST:</p> <ul style="list-style-type: none"> • Ein Druckverlust von bis zu 20 % in 24 Stunden ist zulässig <p>(ISO 6185). Wenn Sie Druckverluste oberhalb von den folgenden Werten feststellen:</p> <table style="margin-left: 40px;"> <tr> <td>Schlauchkörper</td> <td>= 0.145 PSI (0.010 Bar)/5 Stunden</td> </tr> <tr> <td>Hochdruck-Luftboden</td> <td>= 0.5 PSI (0.035 Bar)/5 Stunden</td> </tr> </table> <p>Überprüfen Sie bitte die Dichtheit</p> <ul style="list-style-type: none"> • Die Temperatur hat einen großen Einfluss auf den Druck. Eine Veränderung von 1 °C bewirkt eine analoge Veränderung des Drucks von etwa +/-0,004 Bar. <p>Haben Sie ein Problem mit einer Undichtigkeit: prüfen Sie zunächst, ob alle Ventile intakt sind und die Membranen anliegen (keine Verunreinigungen). Fragen Sie Ihren Händler um Rat.</p>	Schlauchkörper	= 0.145 PSI (0.010 Bar)/5 Stunden	Hochdruck-Luftboden	= 0.5 PSI (0.035 Bar)/5 Stunden
Schlauchkörper	= 0.145 PSI (0.010 Bar)/5 Stunden				
Hochdruck-Luftboden	= 0.5 PSI (0.035 Bar)/5 Stunden				

1.3 ZUSÄTZLICHE MASSNAHME BEI GFK-RUMPF-SCHLAUCHBOOTEN: REINIGUNG DES RUMPFES.

- Ziehen Sie den Schlauchkörper ab (bei Booten mit abnehmbarem Schlauchkörper).
- Waschen Sie Deck und Rumpf mit Seife und klarem Wasser ab. Völlig abtrocknen lassen.
- Prüfen Sie, ob die Lenzventile nicht verstopft sind.
- Öffnen Sie die Verschlusskappen der Rumpflerzer, um eventuelles Wasser abzulassen.
- Montieren Sie gegebenenfalls den Schlauchkörper

INSTANDHALTUNG UND PFLEGE

1.4 Pflege von rostfreiem Stahl

Die von uns für unsere Produkte verwendeten rostfreien Stahlsorten haben Top-Qualität. Sie verfügen über einen verstärkten Oberflächenschutz. Dennoch wird auf See durch die Kombination von Wasser und Salz auch rostfreier Stahl scharf angegriffen.

HINWEIS:	<p>Auch rostfreier Stahl ist nicht unverwüstlich und bedarf somit ein Minimum an Pflege und Vorsichtsmaßnahmen.</p> <ul style="list-style-type: none"> • Vermeiden Sie Verunreinigungen, die durch Kontakt mit eisenhaltigen Werkzeugen entstehen. Verwenden Sie verchromtes Werkzeug. • Vermeiden Sie Kratzer auf der Oberfläche. • Waschen Sie häufig die Oberfläche mit frischem Wasser ab. • Bei Bedarf den Schutzfilm mit einem Passiviermittel wieder herstellen (fragen Sie Ihren Händler).
-----------------	-----------------------------------------------------------------------------------------------------------------------------------------------------------------------------------------------------------------------------------------------------------------------------------------------------------------------------------------------------------------------------------------------------------------------------------------------------------------------------------------------------------------------------------------------------

1.5 Instandhaltung und Pflege von Polstern und anderen Materialien

Waschen Sie Polster und Bodenelemente mit Seife und frischem Wasser ab und lassen Sie diese völlig trocknen.

Farben und Lackierungen sind nicht nur dekorative Elemente, sondern schützen auch die Materialien. Sobald Sie oberflächliche Farbabbblätterungen bemerken, streichen Sie mit Farbe - basierend auf Polyurethan - nach.

2. EINWINTERUNG - LAGERUNG

Wenn Sie Ihr Boot über Winter einlagern, so lagern Sie es an einem sauberen und trockenen Ort, an dem die großen Temperaturschwankungen und andere Schadensfaktoren nicht unmittelbar einwirken können.

Sie können Ihr Boot lagern:

- Entlüftet und aufgerollt verpackt im Packsack.
- Aufgebaut und leicht aufgeblasen.

	<ul style="list-style-type: none"> • Bei einer Langzeiteinlagerung in der Sonne (besonders in tropischen Regionen) schützen Sie Ihr Boot mit einer Schutzabdeckung aus unserem Angebot. • Nagetiere (Mäuse, Ratten) kauen Gewebe einschließlich Schlauchbootmaterial. LAGERN SIE IHR BOOT FREI VON NAGETIEREN. • Falls Sie ihr Boot aufgeblasen lagern, stellen Sie sicher, dass es nicht deformiert lagert.
-------------------------------------------------------------------------------------	--------------------------------------------------------------------------------------------------------------------------------------------------------------------------------------------------------------------------------------------------------------------------------------------------------------------------------------------------------------------------------------------------------------------------------------------------------------------

3. REGELMÄSSIGE ÜBERPRÜFUNGEN

- Prüfen Sie häufig Ihre Lenkgestänge, Gurte und Leinen. Ersetzen Sie verbrauchte Artikel.
- Kontrollieren Sie häufig alle Schrauben und Muttern auf deren festen Sitz, insbesondere die Motorverbolzung am Heckspiegel.
- Prüfen Sie regelmäßig Ihr Kraftstoff-System. Ersetzen Sie verbrauchte oder gealterte Bestandteile. Prüfen Sie den festen Sitz der Schlauchschellen.

INSTANDHALTUNG UND PFLEGE

4. WIE MAN KLEINE REPARATUREN AUSFÜHRT

HINWEIS:	<p>Ihr Boot wird mit einem Reparatursatz geliefert, der an Bord sein muss.</p> <p>Reparaturen während der Fahrt sind ein schwieriges Unterfangen. Halten Sie sich so viel und so gut wie möglich an die nachstehenden Anweisungen. Sobald Sie wieder an Land sind, erneuern Sie die Reparatur oder lassen Sie diese von Ihrem Händler erneut machen.</p>
-----------------	----------------------------------------------------------------------------------------------------------------------------------------------------------------------------------------------------------------------------------------------------------------------------------------------------------------------------------------------------------

REPARATURSATZ	<p>Reinigung:</p> <ul style="list-style-type: none"> ➤ Mildes Lösungsmittel für die Reinigung (Ethylacetat, nicht inbegriffen) <p>Reparieren:</p> <ul style="list-style-type: none"> ➤ Flicken ➤ Klebetube oder zur Verfügung gestellter Reparaturpatch (Patch'n Go) ➤ Pinsel - Bürste.(nicht inbegriffen) ➤ Gebrauchsanleitung
MINDESTANFORDERUN GEN FÜR EINE ERFOLGREICHE REPARATUR	<ul style="list-style-type: none"> ➤ Relative Luftfeuchtigkeit darf 60 % nicht überschreiten. ➤ Temperatur sollte zwischen 18 und 25 °C betragen. ➤ Vermeiden Sie Reparaturen in direkter Sonneneinstrahlung und im Regen ➤ Prüfen Sie, ob der Schlauchkörper völlig entlüftet ist und flach aufliegt.
VORBEREITUNG	<ul style="list-style-type: none"> ➤ Die Leckagen ausfindig machen, bei Bedarf, wenn nicht direkt sichtbar, mit Seifenwasser ➤ Schneiden Sie einen kreisrunden Flicken aus, der mindestens 5 cm größer ist als der Schaden (Riss oder Loch). ➤ Markieren Sie den Umriss des Flickens exakt an der Stelle, wo er aufgeklebt werden soll. ➤ Reinigen Sie die beschädigte Fläche und die entsprechende Seite des Flickens mit einem Fett-Entferner. ➤ Lassen Sie die Flächen 5 Minuten abtrocknen.
KLEBEN	<ul style="list-style-type: none"> ➤ Tragen Sie in 3 Arbeitsgängen je 1 dünne Lage Kleber auf den Flicken und die betreffende Fläche des Bootes auf. Lassen Sie die Flächen nach jeder Beschichtung 3 - 5 Minuten abtrocknen (der Kleber darf nicht mehr am Finger haften, aber auch nicht zu trocken sein).

FLICKEN AUFSETZEN	<ul style="list-style-type: none"> ➤ Sobald die 3. Lage Kleber angetrocknet ist, legen Sie den Flicker ohne Druck auf; falls erforderlich Lage korrigieren. ➤ Drücken Sie von innen nach außen eventuelle Luftblasen unter dem Flicker heraus. ➤ Glätten Sie den Flicker mit einem abgerundeten Gegenstand (z.B.: Teelöffel) von der Mitte des Flicker nach außen. ➤ Entfernen Sie bei Bedarf überschüssigen Kleber mit Lösungsmittel.
BEHANDLUNG DES BOOTES NACH DER REPARATUR	<ul style="list-style-type: none"> ➤ Setzen Sie die reparierte Stelle weder Sonne noch Regen aus. ➤ Lassen Sie die Verklebung 24 Stunden trocknen, bevor Sie den Schlauchkörper wieder aufblasen.
<div style="text-align: center;">  <p>ACHTUNG</p> </div>	<p>Setzen Sie die Tube weder Sonne, noch Wärmequellen oder offenem Feuer aus.</p> <p>Arbeiten Sie an einem belüfteten Ort. Vermeiden Sie es, Ausdünstungen oder Dämpfe des Klebers einzusatmen oder zu schlucken. Vermeiden Sie Kontakt mit Haut oder Augen.</p>

5. SCHLAUCHBOOTE MIT GFK-RUMPF: KLEINE REPARATUREN AM RUMPF

- Kleinere Kratzer können mit Politur oder ähnlich angepassten Produkten entfernt werden.
- Tiefere Kratzer können mit Polyesterspachtelmasse oder Gelcoat repariert werden. In diesem Fall wenden Sie sich bitte an Ihren Händler.

HINWEIS:	Für eine größere Reparatur am Schlauchkörper oder Rumpf sollten Sie Ihr Boot zu Ihrem Händler bringen, der über die geeigneten Produkte, Werkzeuge und die notwendige Erfahrung verfügt, um qualitativ hochwertige Reparaturen durchzuführen.
-----------------	-----------------------------------------------------------------------------------------------------------------------------------------------------------------------------------------------------------------------------------------------

FEHLERSUCHE: FEHLERURSACHE UND -BEHEBUNG

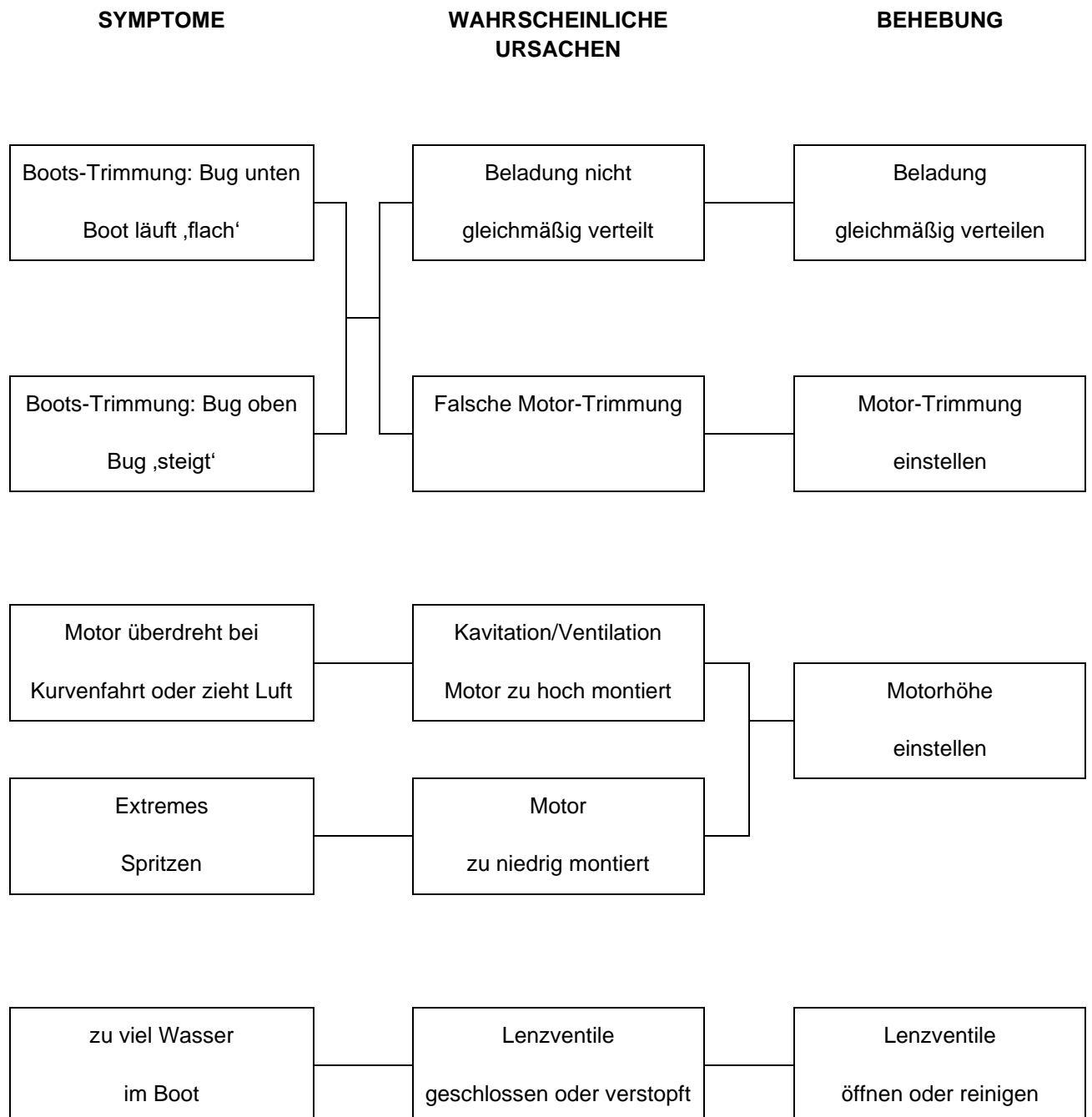

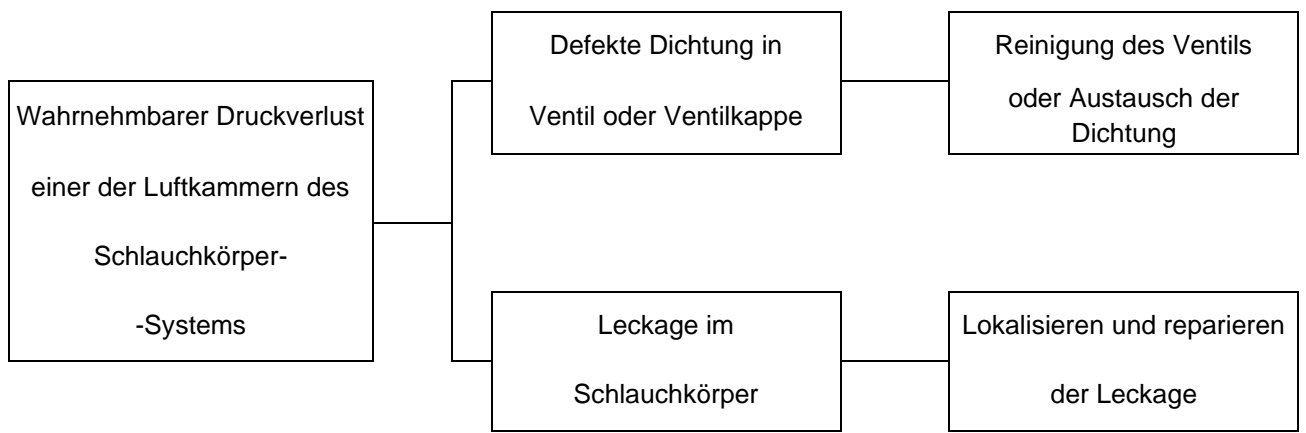
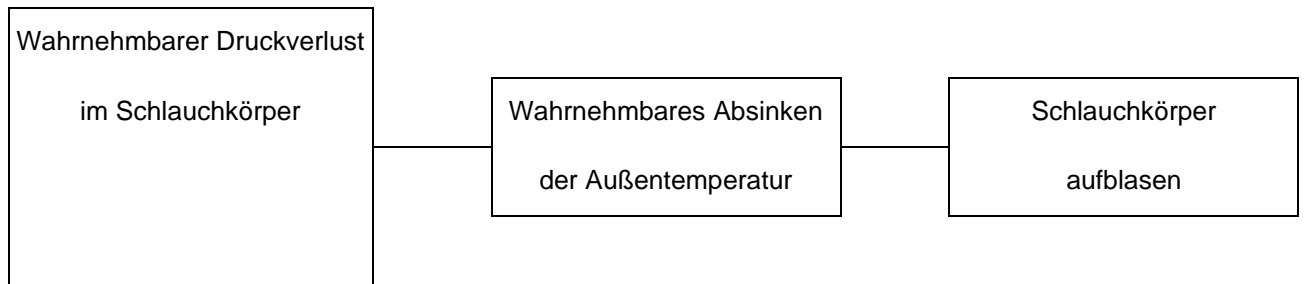

GARANTIE - ALLGEMEINE BEDINGUNGEN

HINWEIS:	<p>Vergewissern Sie sich bei Ihrem Händler, dass er Ihr Boot korrekt eingetragen hat, damit die Herstellergarantie in Kraft tritt. Er wird Sie über die Anwendungsbedingungen informieren.</p> <p>Jeglicher Garantieanspruch muss ebenfalls über Ihren Händler laufen.</p>
-----------------	----------------------------------------------------------------------------------------------------------------------------------------------------------------------------------------------------------------------------------------------------------------------------

Wesentliche Einschränkungen in der Anwendung oder Ausschluss dieser Garantie betreffen folgendes:

- Das Boot darf nicht verändert werden und/oder mit einem Motor ausgerüstet werden, der den vom Hersteller zugelassenen Leistungswert überschreitet, oder für Aktivitäten verwendet werden, die außerhalb der normalen Freizeit-Nutzung liegen (Rennen, professionelle Verwendung usw.).
- Betrieb mit Zuladungen, die größer sind als die vom Hersteller zugelassene Zuladung des Bootes.
- Nichtbeachtung oder Vernachlässigung der Hinweise zum Betriebsdruck, Auf- und Abbau-Anleitung sowie Handhabungs-Verfahren.
- Nichtbeachtung oder Vernachlässigung der Empfehlungen zur Pflege/Instandhaltung und Lagerung.
- Die Garantie erstreckt sich nicht auf Teile und Zubehör, die vom Hersteller nicht geliefert wurden, oder auf Mängel, die als Folge aus der Installation solcher Teile und Zubehör an seinen Produkten entstehen.

 WARNUNG	<p>Ihr Boot wurde in Übereinstimmung mit den Normen und für eine bestimmte Verwendung hergestellt. Jegliche Modifizierung oder Veränderung des Bootes oder die Verwendung eines Motors mit einer höheren Motorleistung als der vom Hersteller zugelassenen, können ernste Risiken für den Benutzer zur Folge haben und bedingen in jedem Fall den Verlust jeglicher Garantieansprüche.</p>
-------------------------------------------------------------------------------------------------------	--------------------------------------------------------------------------------------------------------------------------------------------------------------------------------------------------------------------------------------------------------------------------------------------------------------------------------------------------------------------------------------------

HINWEIS:	<p>ALLE REPARATUREN IM RAHMEN DER GARANTIE DÜRFEN NUR VON EINEM VON UNS ZUGELASSENEM HÄNDLER AUSGEFÜHRT WERDEN.</p>
-----------------	----------------------------------------------------------------------------------------------------------------------------

**Z NAUTIC
2 chemin la Val Priout
31450 AYGUESVIVES
FRANKREICH**

611957. - A

Manual del propietario

Tomo 1 ASPECTOS GENERALES - PRECAUCIONES - SEGURIDAD

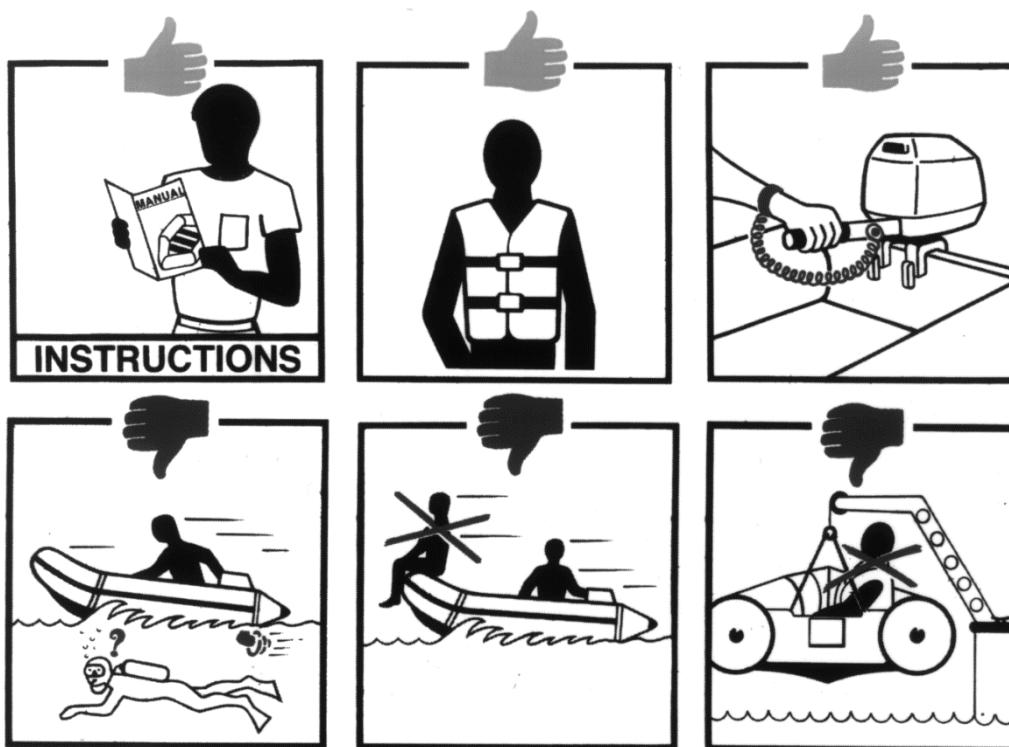

- LEA DETENIDAMENTE ESTE MANUAL ANTES DE PUESTA EN SERVICIO DE SU EMBARCACIÓN.
- EL MANUAL DEL PROPIETARIO SE DIVIDE EN DOS TOMOS

ADVERTENCIA	
--------------------	--

<p>NOTA:</p>	<p>El manual del propietario se divide en dos tomos:</p> <p>El tomo 1</p> <p>Trata de un modo general sobre las precauciones de uso y consejos a tener en cuenta a bordo de la embarcación y en el agua.</p> <p>El tomo 2</p> <p>Trata más detalladamente sobre las características técnicas y el montaje de la embarcación y su equipamiento.</p>
---------------------	-------------------------------------------------------------------------------------------------------------------------------------------------------------------------------------------------------------------------------------------------------------------------------------------------------------------------------------------------------------------------

	<p>Navegar es un placer y queremos que lo disfrute durante muchos años.</p> <p>Por favor, lea detenidamente este manual del propietario para familiarizarse con los consejos de navegación y las medidas de seguridad que en él aparecen.</p> <p>Y recuerde, ¡la seguridad ante todo!</p>
-------------------------------------------------------------------------------------	----------------------------------------------------------------------------------------------------------------------------------------------------------------------------------------------------------------------------------------------------------------------------------------------------------------

TOMO 1

ASPECTOS GENERALES - PRECAUCIONES - SEGURIDAD



ÍNDICE

	Página		Página
⇒ Señales de seguridad	2	⇒ Manipulación	
		1. fondeo y remolcado	15
⇒ Mensaje importante - Validez	3	2. izado - colocación en pescantes	15
		3. puesta en remolque	16
⇒ Identificación - Certificación	4		
		⇒ Mantenimiento	
⇒ Placa del constructor	4-6	1. limpieza	17-18
		2. Invernaje - Almacenaje	18
⇒ Elección y ajustes del motor		3. comprobaciones diversas	18
1. elección del motor	7	4. reparación de pequeños pinchazos	19
2. elección de la hélice	7	5. semi-rígidas: pequeñas reparaciones	19
3. instalación del motor	8		
4. ajustes	8-9	⇒ Anomalías - causas / soluciones	20
⇒ Consejos de navegación	10-13	⇒ Condiciones generales de la garantía	21
⇒ Medio ambiente	14	⇒ A su servicio	22



SEÑALES DE SEGURIDAD

Este manual contiene información esencial para la protección de los usuarios y del material. Los símbolos que figuran a continuación representan las advertencias relativas a cada situación.

RECOMENDACIONES DE SEGURIDAD

 <p>PELIGRO</p>	<p>Significa que hay un peligro extremadamente grave que, con alta probabilidad, podría ocasionar la muerte o lesiones irreparables si no se toman medidas especiales.</p>
 <p>ADVERTENCIA</p>	<p>Significa que hay un peligro que podría provocar lesiones o la muerte si no se toman medidas especiales.</p>
 <p>ATENCIÓN</p>	<p>Indica un recordatorio de las medidas de seguridad o una llamada de atención sobre prácticas peligrosas que podrían provocar lesiones personales o dañar la embarcación o sus componentes.</p>

RECOMENDACIONES GENERALES

	<p>El procedimiento seguido o el comportamiento a adoptar son conformes a las prescripciones.</p>
	<p>El procedimiento seguido o el comportamiento a adoptar no son conformes a las prescripciones y hay riesgo de dañar gravemente el material o el entorno.</p>
<p>NOTA:</p>	<p>Llama la atención sobre indicaciones importantes.</p>

MENSAJE IMPORTANTE

Es usted propietario de una embarcación neumática, le agradecemos su confianza y le aconsejamos que lea atentamente este manual.

Se ha redactado para ayudarle a utilizar su embarcación de manera placentera, cómoda y segura. El Tomo 2 contiene la descripción de la embarcación, los equipamientos incluidos o instalados, y los métodos e indicaciones necesarios para su puesta en servicio y su mantenimiento. Léalo con atención y familiarícese con la embarcación antes de utilizarla.

El piloto es responsable del buen funcionamiento de la embarcación y de la seguridad de sus pasajeros. Si se trata de su primera embarcación y no está familiarizado con nuestros productos, para su confort y seguridad, asegúrese de que tiene una mínima experiencia antes de asumir "el mando". Su vendedor, concesionario, federación náutica nacional o club, estarán encantados de informarle acerca de escuelas de navegación e instructores competentes.

 ATENCIÓN	<ul style="list-style-type: none"> • Le aconsejamos que guarde el manual del propietario a bordo de su embarcación, en un lugar seco, seguro y fácilmente accesible, para que lo pueda consultar el piloto. • TAMBIÉN SE RECOMIENDA CONSERVAR JUNTO AL MANUAL LAS INSTRUCCIONES ENTREGADAS POR LOS FABRICANTES DEL EQUIPAMIENTO DE LA EMBARCACIÓN (MOTOR, BATERÍAS, ETC.). • El presente manual forma parte del equipamiento de la embarcación y debe incluirlo en caso de cesión o reventa.
-------------------------------------------------------------------------------------------------------	----------------------------------------------------------------------------------------------------------------------------------------------------------------------------------------------------------------------------------------------------------------------------------------------------------------------------------------------------------------------------------------------------------------------------------------------------------------------------------------------------------------------------------------------------

VALIDEZ

Deseosos de que nuestros clientes se beneficien de la evolución constante de nuestros productos, nos reservamos el derecho de modificar sin previo aviso las características y disponibilidad de modelos de nuestras gamas.

La información recogida en este manual corresponde a las características de la embarcación en el momento de la edición. Esta información no es en ningún caso contractual.

NOTA:	El incumplimiento de las instrucciones recogidas en este manual liberaría de toda responsabilidad al fabricante.
--------------	-------------------------------------------------------------------------------------------------------------------------

HOMOLOGACIÓN / CERTIFICACIÓN / IDENTIFICACIÓN

Nuestras embarcaciones cumplen la norma ISO 6185, establecida por la organización internacional de estandarización. Son conformes a la Directiva Europea 2013/53/EU.

Somos también miembros de la Asociación de Fabricantes de la Industria Náutica de los Estados Unidos (NMMA), de la Federación de Industrias Náuticas (FIN) francesa y de la Asociación para el recreo eco-responsable (APER), que permite a los propietarios desmantelar su embarcación matriculada en Francia al final de su vida útil de manera gratuita.

Para asegurar la identificación de su embarcación (seguros, Servicio Post Venta, etc.), ponga sobre la placa (figura más abajo) las indicaciones importantes que figuran en la placa del fabricante fijada en el interior del espejo de popa.

Anote especialmente el modelo (1), y número de serie (2) de su embarcación, así como el número de identificación individual grabado en la pequeña placa (11) fijada en el interior del espejo de popa, cerca del motor.

① Placa del fabricante

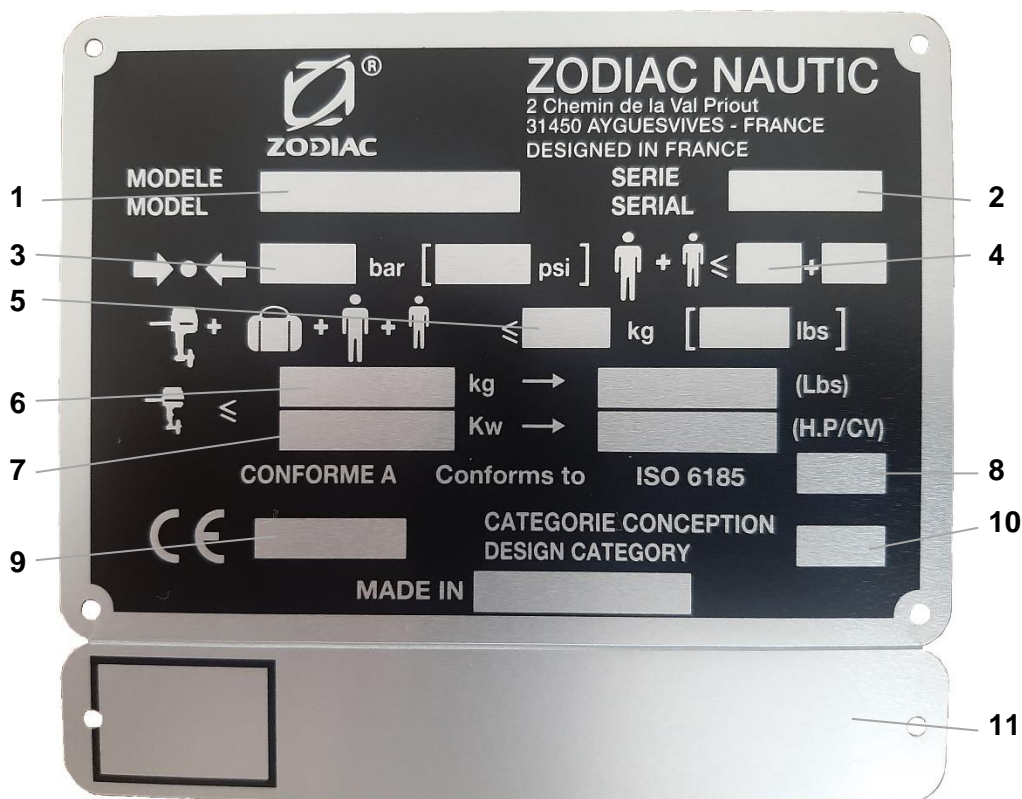

PLACA DEL FABRICANTE

Las indicaciones que figuran en la placa del constructor situada sobre el espejo de popa, son importantes.

Indican principalmente las limitaciones impuestas por las normas vigentes en la mayoría de países y el tipo de uso para el que está diseñada la embarcación.

Las indicaciones que le facilitamos **no forman una lista exhaustiva**: las exigencias generales relativas a la navegación (equipo de seguridad obligatorio de la embarcación, distancia máxima autorizada desde un abrigo etc.) pueden variar según el país. **Infórmese y cúmplalas siempre en las reglamentaciones nacionales y locales del país en el que navegue.**

(1) **Modelo**: Nombre comercial de la serie.

(2) **Número de serie**: Identifica la serie de la embarcación. Hay que recordarlo para cualquier operación del SPV, compra de piezas o accesorios.

(3) **Presión nominal de inflado** los flotadores en Bares y en PSI. Otras partes de la embarcación pueden tener presiones diferentes. Infórmese en el capítulo INFLADO (TOMO 2 del Manual del Propietario) o en las indicaciones que figuran en las válvulas.

(4) **Número máximo de personas** autorizadas a bordo de la embarcación en el caso de un equipamiento adaptado (adultos + eventualmente 1 niño) según las normas ISO.

(5) **Carga total máxima** autorizada por el constructor expresada en Kilogramos y en Libras (personas + motor y su depósito lleno + equipamiento (consola, asientos, barra de seguridad + cargas diversas)), determinado según la norma ISO 14945 vigente.

(6) **Peso máximo del motor** autorizado para la embarcación, en Kilogramos y en Libras (pounds).

(7) **Potencia máxima del motor** autorizada para la embarcación, en Kilovatios y en Caballos (Horse-Power).

(8) **Categoría ISO**:

Su embarcación cumple la norma ISO 6185. Su escala de motorización define su categoría.

Categoría ISO	II	V	VII
Escala de motorización en KW	0 - 4,5 kW	4,5 - 15 kW	>15 kW
Escala de motorización en CV	0 - 6 CV	6 - 20 CV	>20 CV

(9) **CE**: Marca de conformidad con la directiva europea 2013/53/EU (a partir de una longitud total de 2,5 m), seguida del número del organismo certificador (solo para embarcaciones con categoría de diseño B).

(10) **La categoría de diseño (directiva Europea 2013/53/EU)** (a partir de una longitud total de 2,5 m):

Según el diseño de su embarcación, está autorizado para navegar en diferentes categorías:

Categoría	B	C	D
Tipo de navegación	"En alta mar"	"En aguas costeras"	"En aguas protegidas"
Fuerza del viento (escala de Beaufort)	Hasta 8 inclusive	Hasta 6 inclusive	Hasta 4 inclusive
Altura significativa de la ola (m)*	Hasta 4 inclusive	Hasta 2 inclusive	Hasta 0,5 inclusive

**Representa la altura media del tercio superior de las olas, lo que se corresponde aproximadamente a la altura de la ola estimada por un observador experimentado. Algunas olas tendrán el doble de altura de este valor.*

Algunas de nuestras embarcaciones están homologadas para dos categorías de navegación. Para una indicación completa de las características relativas a cada categoría, disponen de dos placas de fabricante distintas.

(11) Placa pequeña, generalmente fijada en la cara exterior del espejo de popa, que indica el número individual de identificación de la embarcación (CIN – Craft Identification Number).

 ADVERTENCIA	<p>Compórtese de forma responsable: establezca su plan de navegación teniendo en cuenta estos parámetros, y no se haga a la mar si corre el riesgo de sobrepasarlos.</p>
---------------------------------------------------------------------------------------------------------	---------------------------------------------------------------------------------------------------------------------------------------------------------------------------------

ELECCIÓN DEL MOTOR Y LA HÉLICE

1. ELECCIÓN DEL MOTOR

1.1 Potencia del motor

- Las potencias aconsejadas y máximas se hallan en la tabla de características técnicas de la embarcación (tomo 2 del Manual del Propietario).
- Para potencias menores, escoja los motores de mando popero.

Para más de 25 CV, le recomendamos el uso de un mando a distancia, obligatorio en España, que ofrece mayor confort y seguridad.

 ADVERTENCIA	<p>Si utiliza un motor con una potencia superior a la potencia máxima autorizada (la indicada en la placa del fabricante) podría perder el control y cometería una infracción.</p>
-----------------------------------------------------------------------------------------------------------	-------------------------------------------------------------------------------------------------------------------------------------------------------------------------------------------

NOTA:	<p>La potencia máxima autorizada, cuando sea superior a la potencia máxima recomendada, debe utilizarse con extrema prudencia. Está dirigida exclusivamente a usuarios expertos, utilizando su embarcación en condiciones muy específicas (transporte de cargas pesadas, etc.).</p> <p>Le aconsejamos escoja su motor en función del principal uso que haga de su embarcación y que se ajuste a la potencia aconsejada (tomo 2).</p> <p>Demasiado motorizada, su embarcación corre el riesgo de ser delicada de maniobrar: Insuficientemente motorizada, corre el riesgo de no poseer un margen de seguridad suficiente para remontar vientos y corrientes.</p>
--------------	-----------------------------------------------------------------------------------------------------------------------------------------------------------------------------------------------------------------------------------------------------------------------------------------------------------------------------------------------------------------------------------------------------------------------------------------------------------------------------------------------------------------------------------------------------------------------------------------------------------------------------------------------------------------

1.2 Peso del motor

El peso del motor tiene gran influencia sobre la capacidad de planeo, la estabilidad y las prestaciones de la embarcación. Para igual potencia, le aconsejamos que escoja un motor ligero.

No instale nunca un motor con un peso superior al indicado en la placa del fabricante.

1.3 Tamaño del eje del motor

Hay 4 tipos de eje de motor: **S/L/XL/XXL**. Cada embarcación está diseñada para uno u otro, **sin cambio posible**. Verifique el tipo de eje que se adapta a su embarcación (tomo 2).

2. ELECCIÓN DE LA HÉLICE

• Para poder escoger la hélice adecuada, su embarcación y su motor deben probarse en el agua. Solicite ayuda a su agente.

• En general, la hélice suministrada con el motor es adecuada para cualquier tipo de navegación. Sin embargo, en función del principal uso que haga de su embarcación, opte por:

Un paso corto cuando la embarcación necesite un fuerte empuje para el planeo (embarcación muy cargada, esquí acuático, etc.).

Un paso largo aumentará el potencial de velocidad (si la embarcación está poco cargada).



PELIGRO

El contacto con la hélice en rotación puede provocar graves lesiones e incluso la muerte.

Manténgase siempre a una distancia prudencial de la hélice.

INSTALACIÓN Y AJUSTES DEL MOTOR

3. INSTALACIÓN DEL MOTOR

- Instale el motor en la línea de crujía de la embarcación, en el centro de la placa de refuerzo (4).
- Apriete a mano los tornillos de fijación (1) y vuélvalos a apretar tras 15 minutos de navegación en la primera instalación.
- Para la fijación de los motores, diríjase a su agente más cercano.
- Amarre el motor con un cabo (2) al puente (3) y a los tornillos de fijación (1).
- Todos los motores de más de 4 CV están equipados con un dispositivo cortacircuitos (5), un elemento esencial de seguridad: sujételo siempre a su muñeca (más información en el capítulo "Consejos de Navegación").

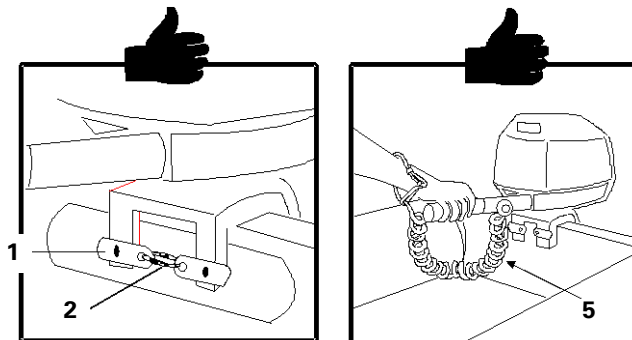
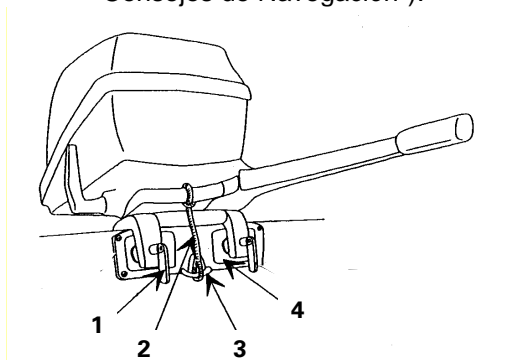

ATENCIÓN

- La fijación del motor se recomienda a partir de 10 cv y es obligatoria a partir de 25 cv.
- Para potencias a partir de 25 cv, recomendamos el uso de un mando a distancia.



ADVERTENCIA

- PARA MOTORES SIN FIJAR: REVISE PERIÓDICAMENTE EL APRIETE DE LOS TORNILLOS de fijación.
- Para los mandos a distancia: revise regularmente su buen funcionamiento.

NOTA:

La fijación del motor sobre el espejo se efectúa después de haber afinado su posicionamiento. Confíe esta operación a su agente.

4. AJUSTES

El motor necesita un doble ajuste de posicionamiento en inclinación y altura respecto al espejo de popa, que tiene una influencia directa e importante sobre el comportamiento de la embarcación.

Una vez correctamente instalado en altura, el motor no necesitará más modificación de posicionamiento. Por el contrario, para optimizar las prestaciones y asegurar la buena maniobrabilidad de la embarcación, es posible que tenga que modificar la inclinación del motor en función de las condiciones de navegación (barra de ajuste o trim eléctrico).

4.1. Altura del motor

El motor se monta directamente sobre el espejo de popa. Según la marca del motor, para un mismo tipo de eje, el tamaño puede variar en algunos centímetros. Quizás sea necesario instalar una galga de ajuste para asegurar el correcto posicionamiento del motor:

Motor con el trimado muy alto = el motor se revoluciona mucho (ventilación)

Motor con el trimado muy bajo = entradas de agua imprevistas (apilado)

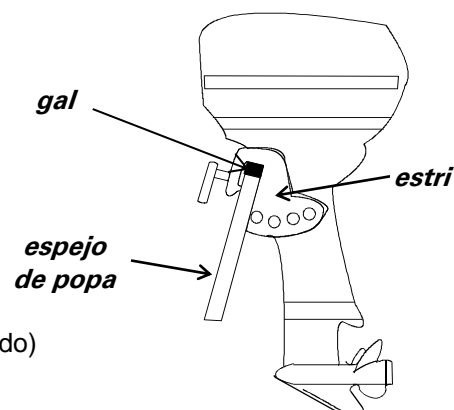

AJUSTES DEL MOTOR



4.2 Trimado del motor

En general, el motor debe estar inclinado de modo que el eje de la hélice esté paralelo a la superficie del agua.

Sin embargo, en ciertas situaciones puede ser conveniente ajustar una inclinación diferente (ver capítulo CONSEJOS DE NAVEGACIÓN).

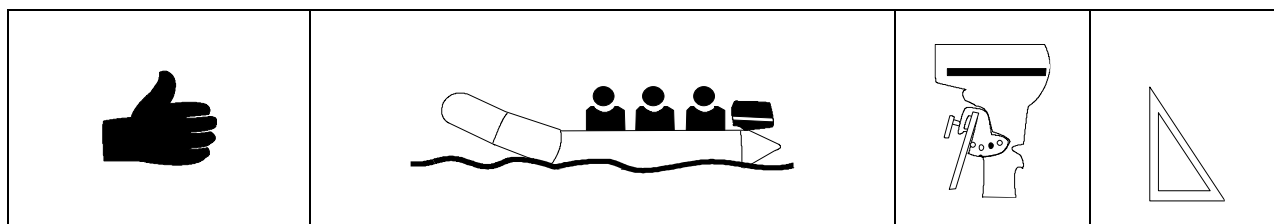
El ajuste del trimado del motor puede efectuarse manualmente o con ayuda del Trim, en los motores que lo integren.

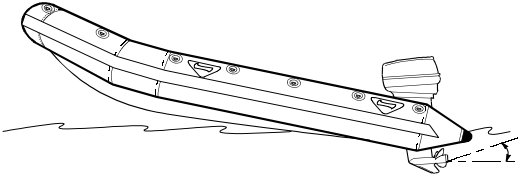
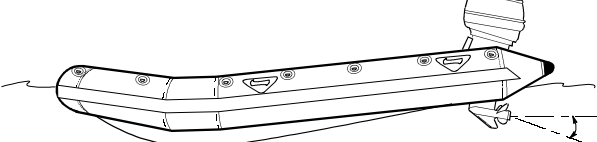

 	<p>Motor demasiado alejado del espejo: La embarcación se encabrita.</p>  <p>Motor demasiado cerca del espejo: La embarcación se hunde de proa.</p> 
------------------------------------------------------------------------------------------------------------------------------------------------------------------------	-------------------------------------------------------------------------------------------------------------------------------------------------------------------------------------------------------------------------------------------------------------------------------------------------------------------------

 ADVERTENCIA	<p>Si el ajuste de la inclinación de su motor es manual, párelo antes de realizar cualquier modificación.</p>
---------------------------------------------------------------------------------------------------------	----------------------------------------------------------------------------------------------------------------------

NOTA:	<p>Para más información acerca de su motor en particular, consulte las instrucciones del constructor.</p>
--------------	-----------------------------------------------------------------------------------------------------------

CONSEJOS DE NAVEGACIÓN

Reparto de la carga:

- Reparta las cargas de modo equilibrado. (Por ejemplo, fijar la nodriza en proa puede ayudar a compensar el peso del motor en popa).
- Durante el pilotaje con timón, el piloto debe estar situado a estribor.

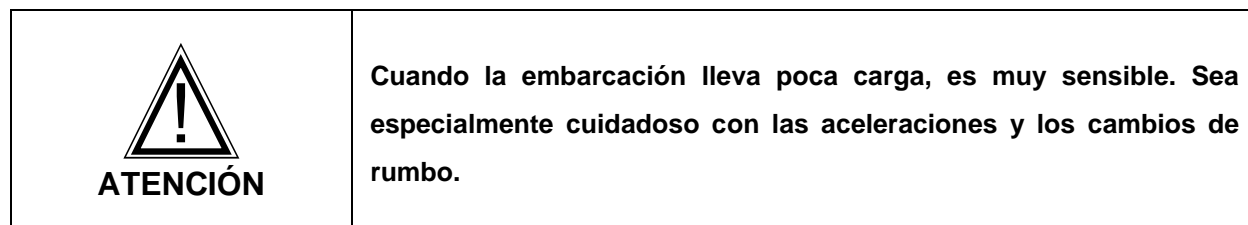
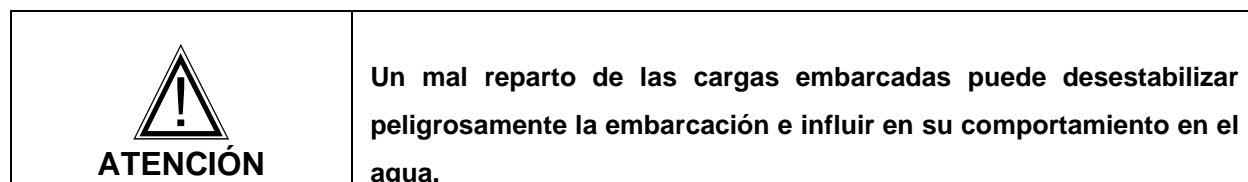
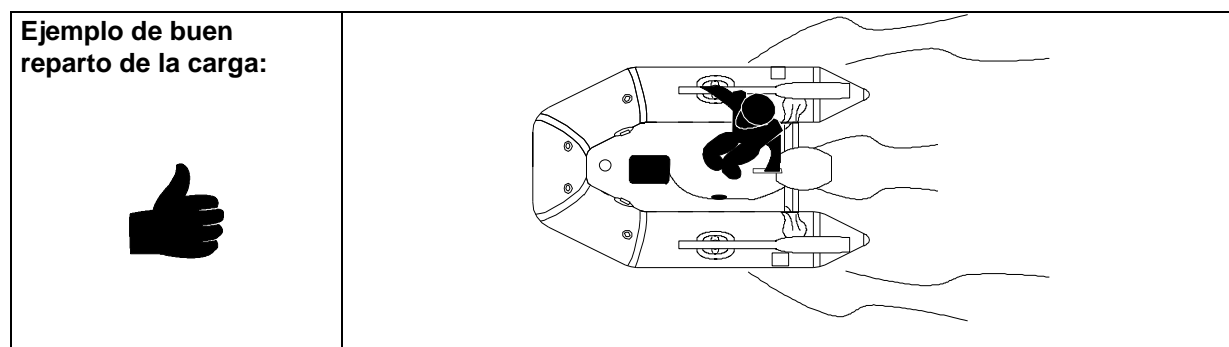

Según las condiciones de navegación y el estado de la mar, puede ser necesario modificar el reparto de la carga y la inclinación del motor:

Mar agitado de proa

Cargue la embarcación en la proa y, si es necesario, ajuste la barra de inclinación del motor

al primer o segundo orificio

TRIM Negativo

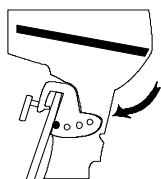

Mar agitado de popa

Cargue la embarcación en la popa y, si es necesario, ajuste la barra de inclinación del motor

al tercer o cuarto orificio

TRIM Positivo

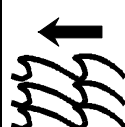
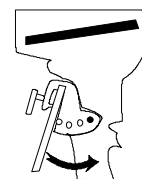

ATENCIÓN

No haga navegar la embarcación con un ajuste de asiento negativo (cáncamo de roda bajo) a gran velocidad. Esto podría hacer que la embarcación se balancee y puede provocar inestabilidad en los virajes. Utilice un asiento negativo para cambiar de la velocidad de desplazamiento a la velocidad de hidroplaneo, y a velocidades inferiores con el mar agitado (si su motor dispone de trim eléctrico).

CONSEJOS DE NAVEGACIÓN

LA SEGURIDAD ANTE TODO: Sepa prevenir el riesgo de accidentes.

COMPROBACIONES ANTES DE SALIR

 ADVERTENCIA	<p style="text-align: center;">Infórmese e informe a los pasajeros:</p> <ul style="list-style-type: none"> <input checked="" type="checkbox"/> INFÓRMESE SOBRE LAS REGLAMENTACIONES Y PELIGROS EVENTUALES ESPECÍFICOS DE LA NAVEGACIÓN LOCAL. <input checked="" type="checkbox"/> CONSULTE el parte meteorológico: infórmese de los peligros debidos a las condiciones climáticas, mareas, vientos y corrientes, así como el estado del mar. <input checked="" type="checkbox"/> INFORME a alguien que se quede en tierra de su destino y de la hora aproximada de su vuelta. <input checked="" type="checkbox"/> APRENDA a determinar la autonomía de su embarcación: la distancia que puede cubrir con el depósito lleno de combustible varía sensiblemente según el estado de la mar. Asegúrese de llevar siempre una reserva suficiente para alcanzar un refugio. <input checked="" type="checkbox"/> EXPLIQUE las maniobras básicas a todos los pasajeros. <input checked="" type="checkbox"/> ASEGÚRESE de que uno de sus pasajeros sepa gobernar la embarcación en caso de emergencia.
	<p style="text-align: center;">Verifique el buen funcionamiento del material según el estado del mar y el uso.</p> <ul style="list-style-type: none"> <input checked="" type="checkbox"/> VERIFIQUE la presión del flotador. <input checked="" type="checkbox"/> VERIFIQUE los pasacascos: retire los tapones de achique y compruebe el cierre de los espiches en el interior de la embarcación. <input checked="" type="checkbox"/> VERIFIQUE el buen funcionamiento del cortacircuitos. <input checked="" type="checkbox"/> VERIFIQUE la correcta fijación del motor al espejo de popa. <input checked="" type="checkbox"/> VERIFIQUE y limpie el filtro de gasolina, si dispone de él. <input checked="" type="checkbox"/> VERIFIQUE la cantidad de combustible disponible. <input checked="" type="checkbox"/> PROCURE rellenar el aceite si su motor tiene depósito de aceite separado. <input checked="" type="checkbox"/> AMARRE su depósito en el emplazamiento designado. Revise la fijación de todos los elementos móviles. <input checked="" type="checkbox"/> VERIFIQUE que su motor está en punto muerto antes de arrancar.

	<p style="text-align: center;">MATERIAL A EMBARCAR: (infórmese sobre la reglamentación de su país).</p> <p><input checked="" type="checkbox"/> Un chaleco salvavidas por cada persona a bordo y adaptado a la morfología de la persona y a la zona de navegación.</p> <p><input checked="" type="checkbox"/> El inflador, las pagayas (o remos), el maletín de reparaciones, las herramientas del motor.</p> <p><input checked="" type="checkbox"/> El material de seguridad obligatorio.</p> <p><input checked="" type="checkbox"/> La documentación de la embarcación y su carnet de piloto.</p> <p><input checked="" type="checkbox"/> Una linterna eléctrica (además de las luces de navegación reglamentarias) en caso de navegación nocturna.</p>
--	--------------------------------------------------------------------------------------------------------------------------------------------------------------------------------------------------------------------------------------------------------------------------------------------------------------------------------------------------------------------------------------------------------------------------------------------------------------------------------------------------------------------------------------------------------------------------------------------------------------------------------------------------------------------------------------------------------------------------------------------------------------------

CONSEJOS DE NAVEGACIÓN

LA SEGURIDAD ANTE TODO: SEPA PREVENIR LOS RIESGOS DE ACCIDENTES.

REGLAS QUE SEGUIR EN LA NAVEGACIÓN

- Comportese de forma responsable, no ponga en peligro su vida ni la de otros por negligencia en el cumplimiento de las reglas de seguridad.
- Respete las normas de prioridad definidas por las reglas de rumbo y gobierno impuestas por el COLREG (Reglamento Internacional para Prevenir los Abordajes en Mar – RIPAM)
- Asegúrese de mantener siempre una distancia suficiente para detenerse o maniobrar si fuese necesario para evitar una colisión.
- No navegue a la máxima velocidad en zonas con tráfico intenso, ni en caso de visibilidad reducida, fuertes vientos o grandes olas.
- Reduzca la velocidad y la formación de estelas, por cortesía y para su propia seguridad y la de los demás. Respete las zonas con limitación de velocidad y de estelas.
- Mantenga siempre el control de su embarcación y preste una atención constante durante la navegación.
- Comportese siempre de modo respetuoso y cortés.
- Respete las reglamentaciones vigentes en su zona de navegación.
- Cuando se acerque a la orilla, navegue por los canales balizados y a baja velocidad.
- En el mar, las condiciones meteorológicas pueden empeorar rápidamente. Asegúrese siempre de poder alcanzar un refugio rápidamente.



¡DESCONFÍE DE VIENTOS Y CORRIENTES QUE LE LLEVEN HACIA ALTA MAR!



ADVERTENCIA

CHALECOS SALVAVIDAS: recomendamos llevar puesto el chaleco salvavidas durante la navegación y, sin excepción, los niños y los no nadadores.

CORTACIRCUITOS: póngaselo siempre, preferentemente en la muñeca, o en su lugar, en una parte fija de la vestimenta que lleve. Tome todas las precauciones para evitar que accione accidentalmente el cortacircuitos, lo que ocasionaría una pérdida de control, especialmente peligrosa durante las maniobras.

NI ALCOHOL, NI DROGAS: no pilote después de haber consumido alcohol o drogas. Controle la sobriedad de sus pasajeros.

No supere nunca los valores admisibles de pasajeros, de potencia o de peso.

Procure que los pasajeros no vayan nunca sentados en la proa con las piernas por fuera: En caso de caída, la persona que está en el agua se halla en el camino de la hélice.

PROCURE que los pasajeros se encuentren en posición de seguridad, y evite cambios de rumbo bruscos a menos que sea absolutamente necesario.

Reduzca la velocidad en las olas para garantizar el confort y la seguridad de todos.

En cualquier caso, avise a los pasajeros antes de realizar la maniobra.

Evite los virajes cerrados a gran velocidad: Corre el riesgo de que sus pasajeros y usted mismo sean lanzados fuera de la embarcación.

TENGA UN ESPECIAL CUIDADO EN EL MOMENTO DEL ATRAQUE: pueden producirse lesiones en brazos y piernas si están en el exterior cuando se efectúe la maniobra.

NO OLVIDE QUE LA HÉLICE ES UN PELIGRO PARA LOS BAÑISTAS Y BUCEADORES:

No permita que sus pasajeros se bañen cuando el motor esté en marcha y tenga mucho cuidado cuando navegue cerca de una zona de baño.

La bandera Alpha indica la presencia de buceadores: es absolutamente obligatorio desviar el rumbo de la embarcación (100 m mínimo).

No abandone nunca la embarcación sin haberla amarrado o fondeado.

CONSEJOS DE NAVEGACIÓN

LA SEGURIDAD ANTE TODO: Sepa prevenir el riesgo de accidentes.

Reglas que seguir en la navegación (continuación)

 <p>ADVERTENCIA</p>	<ul style="list-style-type: none"><input checked="" type="checkbox"/> TENGA CUIDADO: Evite cualquier contacto del flotador con objetos cortantes o agentes agresivos (como el ácido). <input checked="" type="checkbox"/> ATENCIÓN A LA BATERÍA: Tenga cuidado con las descargas eléctricas y el ácido que contiene. <input checked="" type="checkbox"/> EVITE LOS RIESGOS DE EXPLOSIÓN O INCENDIO: Elija cuidadosamente el sistema de alimentación de combustible y manténgalo en buen estado. <input checked="" type="checkbox"/> NO FUME mientras llena el depósito de combustible. <input checked="" type="checkbox"/> Si el combustible se derrama por el fondo de la embarcación, aclárelo con abundante agua.
-------------------------------------------------------------------------------------------------------------	--------------------------------------------------------------------------------------------------------------------------------------------------------------------------------------------------------------------------------------------------------------------------------------------------------------------------------------------------------------------------------------------------------------------------------------------------------------------------------------------------------------------------------------------------------------------------------------------------------------------------------------------------------------------------------------------------------------------------------------------------------------------------------------------------------------------

EN CASO DE ACCIDENTE

En caso de accidente no entre en pánico y tranquilice a los pasajeros. Sepa que la embarcación, incluso deteriorada, será a menudo el mejor resguardo y facilitará su localización. No intente alcanzar la costa a nado.

Una embarcación hinchable es prácticamente insumergible, incluso llena de agua. Si después de un accidente, un compartimiento se deshincha, tire de él hacia el interior de la embarcación y vuelva al abrigo más próximo a velocidad reducida.

En caso de colisión o impacto con un objeto flotante, deténgase para examinar el fondo (el casco en las semi-rígidas), los flotadores, el motor y sus fijaciones antes de volver a velocidad reducida.

Antes de su próxima salida, confíe su embarcación a su concesionario, quien efectuará una inspección rigurosa.





No realizar un examen de los daños y las reparaciones correspondientes, reduce la resistencia y la vida útil de su embarcación y puede originar de futuros accidentes.

MEDIO AMBIENTE

Para una navegación responsable

Su embarcación le permitirá descubrir la riqueza natural del medio ambiente marino, nosotros le invitamos a respetarlo aplicando las siguientes reglas básicas:

	<ul style="list-style-type: none"> <input checked="" type="checkbox"/> Respete la vida de la fauna marina. <input checked="" type="checkbox"/> Infórmese sobre las normativas internacionales contra la contaminación del medio marino (MARPOL) y respétalas en la mayor medida posible. <input checked="" type="checkbox"/> Manténgase informado de las normativas locales sobre el respeto al medio ambiente y siga los códigos de buenas prácticas. <input checked="" type="checkbox"/> Si su embarcación está equipada con aseos y depósitos de retención, no los descargue cerca de la costa ni en zonas prohibidas. Para ello, utilice el sistema de bombeo de los puertos. <input checked="" type="checkbox"/> Utilice pinturas (antifouling) y productos de limpieza que no sean contaminantes. <input checked="" type="checkbox"/> Aléjese de las zonas reservadas a los bañistas. <input checked="" type="checkbox"/> Limite los ruidos: sea respetuoso con los demás, evite los ruidos excesivos y las emisiones de gas del tubo de escape. <input checked="" type="checkbox"/> Preste atención mientras llena el depósito de combustible. El combustible sobrante recogido en la bandeja de retención debe enjugarse cuidadosamente y tirarse a un contenedor de residuos adaptado para evitar que se vierta accidentalmente al mar.
	<ul style="list-style-type: none"> <input checked="" type="checkbox"/> No arroje hidrocarburos (aceites y carburantes) en el medio natural. <input checked="" type="checkbox"/> No arroje al agua sus residuos o bolsas de basura. <input checked="" type="checkbox"/> No provoque remolinos y estelas molestas para las personas que están en la orilla.

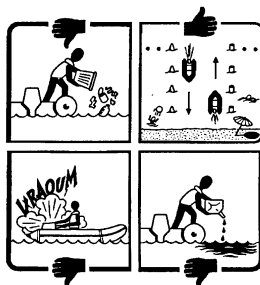

MANIPULACIÓN

1. FONDEO Y REMOLCADO

1.1 Fondeo

Embarcaciones plegables: utilice las anillas laterales del flotador.

Embarcaciones semi-rígidas: utilice el cáncamo de roda.

NOTA:	En fondeo prolongado, los achiques pueden permanecer abiertos para asegurar la evacuación de agua en caso de lluvia abundante.
--------------	--------------------------------------------------------------------------------------------------------------------------------



1.2 Remolcado

Para amarrar una embarcación plegable a un remolque en navegación, utilice un cabo pasado en forma de "V" por las dos anillas laterales del flotador previstas a tal efecto. Para las embarcaciones semi-rígidas, amarre directamente el cabo al cáncamo de roda del casco.

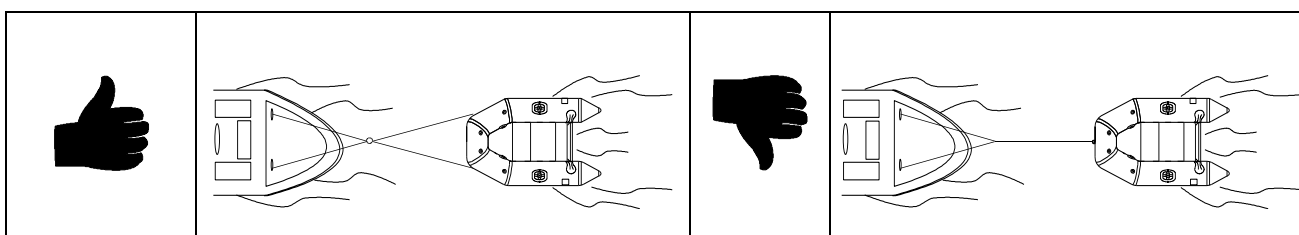

Remolcado de embarcaciones plegables:

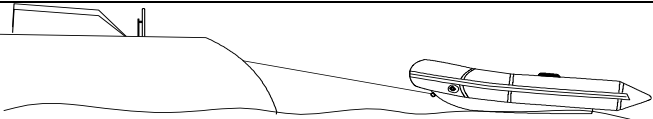

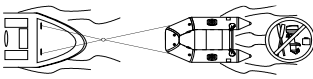
Remolcado de semi-rígidas:

Utilice el cáncamo de roda		
Descargue la embarcación de todo peso antes del remolcado (bolsas, depósitos, motor, remos).		

NOTA:	el remolcado solo debe efectuarse a velocidad baja y en condiciones meteorológicas favorables (mar en calma, viento suave).
--------------	-----------------------------------------------------------------------------------------------------------------------------

 <p>ATENCIÓN</p>	<p>Los puntos de anclaje que presenten signos visibles de deterioro deben cambiarse. Deben ser revisados regularmente.</p>
 <p>ATENCIÓN</p>	<p>Un cable de remolque debe estar siempre amarrado de forma que pueda lanzarse con carga.</p>
<p>NOTA:</p>	<p>Asegúrese de que los cabos de amarre, los cables de remolque, las cadenas y las líneas de fondeo, así como las anclas, sean adecuados para el uso previsto de la embarcación, sobre todo, que las líneas o cadenas no superen el 80% de la resistencia a la rotura del punto de anclaje correspondiente (consulte el tomo 2). Si es necesario, solicite ayuda a su agente.</p>

1.3 Amarre a un muelle o pantalán

La embarcación puede amarrarse a un muelle o pantalán con, al menos, dos cabos llamados amarras: Una en la proa y la otra en la popa.

La amarra puede atarse a un punto fijo y con la fuerza suficiente de la embarcación:

- Embarcaciones semi-rígidas: Cornamusa, cáncamo de roda, bita de amarre, anilla del espejo de popa. (No utilice los puntos no previstos en este fin: relinga/guirnalda, asa de transporte, púlpito, pasamanos, anilla pequeña del flotador, etc.)

- Embarcaciones plegables y anexos: Cornamusa, anillo del espejo de popa, anilla de remolque, asa de proa. (No utilice los puntos no previstos en este fin: relinga/guirnalda, asa de transporte, anilla pequeña del flotador, etc.)



La embarcación debe estar protegida obligatoriamente con defensas frente a los roces contra el muelle/pantalán.

Las amarras no deben rozar contra el flotador. Si la configuración del muelle/pantalán no permite evitarlo, el flotador debe estar protegido en las áreas de roce (tejido grueso o manguera alrededor de la amarra, por ejemplo).

Todas las embarcaciones amarradas a un muelle o pantalán deben ser vigiladas / controladas con regularidad y el amarre debe reforzarse según las condiciones meteorológicas.

2. IZADO - COLOCACIÓN EN PESCANTES:

Para el izado o la colocación en pescantes, utilice las anillas de izado previstas para ello (consulte el tomo 2) o pida a su agente que se las instale.

 ADVERTENCIA	No debe haber nadie a bordo durante el izado con grúa
 ATENCIÓN	<p>La embarcación debe estar descargada de cualquier material durante el izado con grúa o la colocación de pescantes.</p> <p>Los achicadores deben estar abiertos y la embarcación un poco inclinada hacia popa para asegurar la evacuación del agua.</p>

MANIPULACIÓN

3. PUESTA EN REMOLQUE

- La embarcación debe estar bien inflada.
- Los achicadores deben estar abiertos.

3.1 Embarcaciones plegables:

- Ajuste los rodillos (1) del remolque de modo que aguanten los flotadores de ambos lados y de popa.
- Ice la embarcación por la proa, utilizando las anillas laterales.
- La parte inferior del espejo de popa debe apoyarse en el remolque.
- Ponga el motor en posición de navegación de modo que encuentre un apoyo disponible en el remolque (2).
- Asegúrese de que la embarcación esté bien fijada y en plano.
- Retire/amarre todo el material que pueda salir volando.
- Asegure la estabilidad de la embarcación mediante cuñas si es necesario, y apriete firmemente las correas, intercalando protecciones entre éstas y los flotadores para evitar el frotamiento (4).

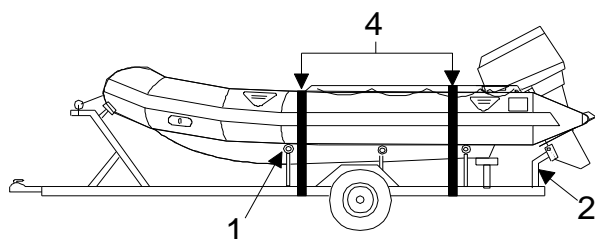

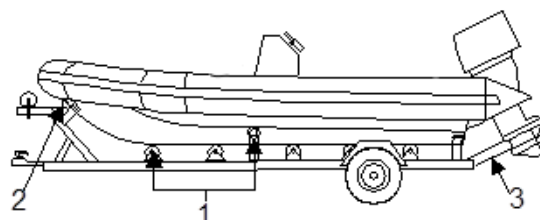

3.2 Embarcaciones semi-rígidas:

- Ajuste los rodillos de la parte central de modo que todo el peso de la embarcación se apoye sobre estos rodillos.
- Ajuste los rodillos o los patines laterales de forma que se estabilice la embarcación (atención, fuera de las tracas y redanes)
- Ajuste la longitud del enganche para que el espejo quede apoyado sobre el último rodillo central.
- Ponga el motor en posición de navegación de modo que encuentre un apoyo disponible en el remolque (3).
- Utilice los anillos de remolque y el cáncamo de roda (si la embarcación está equipada con ellos) para fijar firmemente el casco al remolque.



- Retire o amarre el material que pueda salir volando, incluidos los accesorios y partes móviles.
- Por motivos de seguridad vial, debe cubrir la hélice con una protección eficaz.

 <p>ATENCIÓN</p>	<ul style="list-style-type: none"> • UNA MALA COLOCACIÓN DE LA EMBARCACIÓN SOBRE EL REMOLQUE PUEDE OCASIONAR DEFORMACIONES IRREPARABLES QUE PUEDEN DERIVAR EN VICIOS DE FUNCIONAMIENTO. • No sobrepase nunca el peso máximo admisible del remolque.
------------------------------------------------------------------------------------------------------------	-------------------------------------------------------------------------------------------------------------------------------------------------------------------------------------------------------------------------------------------------------------------------------------------

 <p>ADVERTENCIA</p>	<p>EN CARRETERA:</p> <ul style="list-style-type: none"> • Remolque la embarcación siempre descargada de cualquier material que no esté firmemente atado. • No debe haber ningún pasajero a bordo cuando la embarcación sea remolcada.
---------------------------------------------------------------------------------------------------------------	------------------------------------------------------------------------------------------------------------------------------------------------------------------------------------------------------------------------------------------------------------------------------------

MANTENIMIENTO

El flotador de su embarcación está confeccionado con tejido a base de plastómero. Requiere un mantenimiento sencillo pero necesario para que pueda prolongar la vida útil de su material.

1. LIMPIEZA

Limpie la embarcación frecuentemente, y obligatoriamente antes y después del invernaje.

Es fundamental limpiar regularmente su embarcación, especialmente el flotador. También puede encargarse esta tarea a su agente, el cual dispone de todos los productos y la experiencia necesarios para efectuar una limpieza minuciosa que prolongará la vida útil de su embarcación.



**NO UTILICE MATERIAL DE LIMPIEZA
A ALTA PRESIÓN SOBRE LOS TEJIDOS.**

1.1 Limpieza del flotador

Flotador inflado:

- Abra los achicadores y aclare la embarcación con un chorro de agua para eliminar la arena y otros residuos.
- Limpie el flotador regularmente con **agua dulce y jabón**, al menos una vez al mes durante la temporada de uso.
- Elimine las manchas de alquitrán (para las más resistentes, utilice los productos disponibles en su concesionario).
- Inspeccione el flotador con ayuda de agua jabonosa para detectar y reparar posibles fugas de aire.
- Aclare con agua dulce y deje secar.



No utilice detergentes agresivos (ácido, tricloro, gasolina, acetona) ni productos a base de silicona. En caso de derrame sobre el flotador, aclárelo abundantemente con agua.

Al desinflar:

- Compruebe el buen estado y limpieza de las válvulas y sus juntas (estanqueidad, restos de arena, etc.).
- Compruebe que los achicadores no estén obstruidos.

1.2 Compruebe la estanqueidad del flotador:

NOTA:	<p>Con la ayuda de un manómetro (incluido en algunos modelos o disponible en su concesionario), mida la pérdida de presión en el transcurso de 24 horas.</p> <p>BAJADA DE PRESIÓN:</p> <ul style="list-style-type: none"> • Es normal constatar hasta un 20 % de bajada de presión en 24 h. (Normas ISO 6185). Si observa bajadas de presión superiores a: 0,145 PSI (0,010 Bar) / 5 horas para el flotador 0,5 PSI (0,035 Bar) / 5 horas para el suelo hinchable de alta presión <p>revise la estanqueidad.</p> <ul style="list-style-type: none"> • La temperatura influye mucho en la presión. Una variación de 1 °C ocasiona una variación en el mismo sentido de 0,06 PSI (0,004 bar = 4 milibares). <p>Si constata una bajada anómala de presión, verifique minuciosamente las válvulas y sus juntas. Solicite consejo a su agente.</p>
--------------	----------------------------------------------------------------------------------------------------------------------------------------------------------------------------------------------------------------------------------------------------------------------------------------------------------------------------------------------------------------------------------------------------------------------------------------------------------------------------------------------------------------------------------------------------------------------------------------------------------------------------------------------------------------------------------------------------------------------------------------------------------------------------------------------------------------------------------------------------------------------------------------------

1.3 Operación adicional para las embarcaciones semi-rígidas: limpieza del casco.

- Retire el flotador (en las embarcaciones con flotador extraíble).
- Lave el puente y la carena con agua jabonosa, aclare con agua dulce y deje secar.
- Compruebe que los achicadores no estén obstruidos.
- Abra el tapón de espiche para evacuar el agua que pueda haber en el casco.
- Vuelva a montar el flotador si es el caso.

MANTENIMIENTO

1.4 Mantenimiento de las guarniciones inoxidable

Seleccionamos aceros inoxidable de gran calidad con resistencia reforzada a la corrosión. Sin embargo, en el medio marino, están sometidos a fuertes agresiones conjuntas del sol y el agua.

NOTA:	<p>El acero inoxidable no es inalterable y requiere un mínimo de precauciones y mantenimiento:</p> <ul style="list-style-type: none"> • Evite contaminarlo con el contacto de objetos de hierro: Utilice objetos cromados. • Evite rayar la superficie. • Aclárelo a menudo con agua dulce. • Aplique según necesite una capa protectora con una pasta de pasivado (consulte a su agente).
--------------	---------------------------------------------------------------------------------------------------------------------------------------------------------------------------------------------------------------------------------------------------------------------------------------------------------------------------------------------------------------------------------------------------------------------------------------------

1.5 Mantenimiento de la tapicería y otros materiales

Limpie la tapicería y el contrachapado marino con agua dulce y jabón y séquelos.

El barniz y las pinturas no son únicamente elementos decorativos, tienen también una función protectora. Cuando la superficie esté desconchada o descolorida, repíntela con productos a base de poliuretano.

2. INVERNAJE - ALMACENAJE

Fuera de los períodos de utilización, guarde su embarcación en un lugar limpio y seco, al abrigo de grandes cambios de temperatura y de agresiones climáticas externas.

Puede almacenar su embarcación de dos maneras :

- Plegada en su bolsa.
- Montada y ligeramente desinflada.

	<ul style="list-style-type: none"> • En caso de un almacenaje de larga duración expuesta al sol (sobre todo en los trópicos), proteja su embarcación con un toldo de nuestra gama. • Proteja su embarcación de pequeños roedores (ratones y ratas) que pueden agujerear el neumático. • Si guarda su embarcación inflada, tenga cuidado de que no sufra deformaciones.
-------------------------------------------------------------------------------------	------------------------------------------------------------------------------------------------------------------------------------------------------------------------------------------------------------------------------------------------------------------------------------------------------------------------------------------------------------------------------------------------------------------------------

3. COMPROBACIONES DIVERSAS

- Compruebe periódicamente el estado de la timonera, drizas y correas. Haga cambiar las piezas que tengan signos de desgaste.
- Revise frecuentemente el ajuste de los tornillos y tuercas y, en particular, la fijación del motor.
- Examine regularmente el estado del sistema de alimentación e combustible. Haga cambiar las piezas que tengan signos de desgaste o envejecimiento. Verifique el ajuste de las abrazaderas.

MANTENIMIENTO

4. REPARACIÓN DE PEQUEÑOS PINCHAZOS

NOTA:	<p>Su embarcación se entrega con un maletín de reparaciones que debe llevar a bordo.</p> <p>Las reparaciones durante la navegación son delicadas. Respete al máximo y siempre que sea posible estas instrucciones. Una vez en tierra, vuelva a efectuar la reparación o pídaselo a su agente.</p>
--------------	---------------------------------------------------------------------------------------------------------------------------------------------------------------------------------------------------------------------------------------------------------------------------------------------------

MALETÍN DE REPARACIONES	<p>Para limpiar :</p> <ul style="list-style-type: none"> ➤ Disolvente suave para la limpieza (acetona) (no incluido). <p>Para reparar :</p> <ul style="list-style-type: none"> ➤ Trozos de tejido. ➤ Tubo de pegamento o parche de reparación (Patch'n Go) ➤ Pincel - lija (no incluidos) ➤ Ficha de instrucciones
CONDICIONES PARA UNA CALIDAD DE REPARACIÓN ÓPTIMA	<ul style="list-style-type: none"> ➤ Porcentaje de humedad templada: higrometría <60%. ➤ Temperatura entre 18 y 25 °C. ➤ Realice la reparación protegido del sol y en seco. ➤ Flotador en plano, desinflado.
PREPARACIÓN	<ul style="list-style-type: none"> ➤ Localice las fugas (con agua jabonosa si la fuga no se ve a simple vista) ➤ Recorte una pieza redonda que sobrepase en al menos 5 cm el desgarrón del flotador o utilice un parche adaptado del maletín de reparaciones. ➤ Marque sobre el flotador la ubicación del parche. ➤ Limpie el parche y la zona alrededor del desgarrón con disolvente. ➤ Déjelo secar 5 minutos.
ENCOLADO	<ul style="list-style-type: none"> ➤ Encole el flotador y la pieza, aplicando a cada uno 3 capas finas de cola, dejando secar de 3 a 5 m entre cada capa (la cola no debe adherirse al dedo pero no debe quedarse demasiado seca).

<p>COLOCACIÓN DEL PARCHE</p>	<ul style="list-style-type: none"> ➤ Cuando se seque la última capa, coloque el parche sin presionar para poder rectificar un posible mal centrado. ➤ Presione desde el centro hacia afuera para aplastar las posibles burbujas de aire. ➤ Alise fuertemente la pieza con un objeto redondeado empezando por el centro. ➤ Si es necesario, limpie el excedente de cola con disolvente.
<p>ANTES DE UTILIZAR LA EMBARCACIÓN DE NUEVO</p>	<ul style="list-style-type: none"> ➤ Evite exponer la reparación al sol y la lluvia cuando sea posible. ➤ Deje secar durante 24 horas antes de proceder al inflado.
<div style="text-align: center;">  <p>ATENCIÓN</p> </div>	<p>No deje el tubo de cola a pleno sol o cerca de una llama o de un foco de calor.</p> <p>Trabaje siempre en un local aireado. Evite respirar los vapores de la cola, ingerirla, y que entre en contacto con la piel.</p>

5. SEMI-RÍGIDAS: REPARACIÓN DE ARAÑAZOS EN EL CASCO

- Los pequeños arañazos pueden disimularse o eliminarse utilizando pasta para pulir o algodón para dar brillo.
- Los arañazos más profundos se pueden reparar con ayuda de masilla de polyester o de gelcoat de reparación. En este caso, pida consejo a su agente.

<p>NOTA:</p>	<p>Para una reparación importante del flotador o el casco, consulte su agente, el cual dispone de las herramientas, de los productos y de la experiencia necesarios para realizar unas reparaciones de excelente calidad.</p>
---------------------	-------------------------------------------------------------------------------------------------------------------------------------------------------------------------------------------------------------------------------

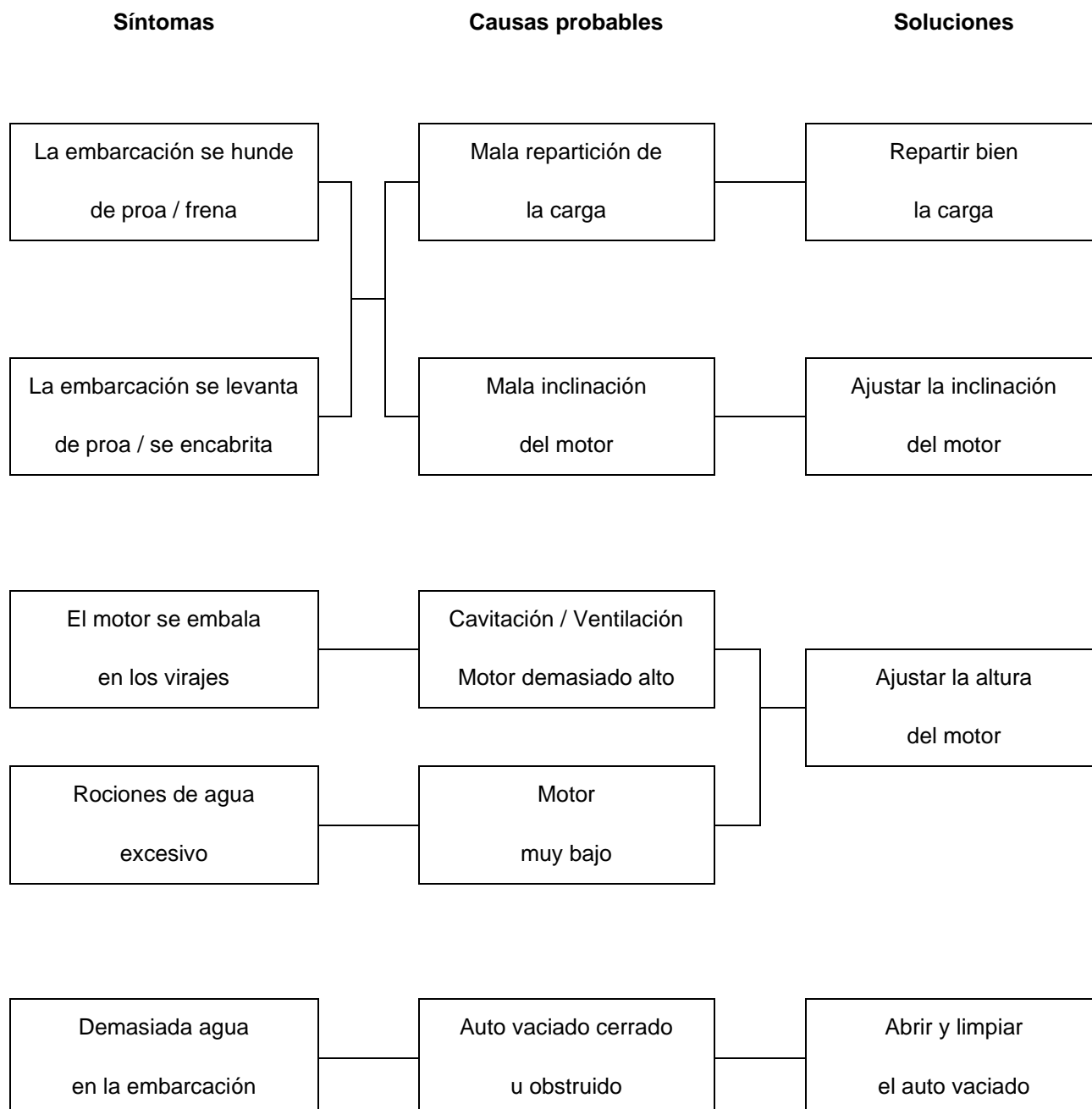
ANOMALÍAS: CAUSAS Y SOLUCIONES

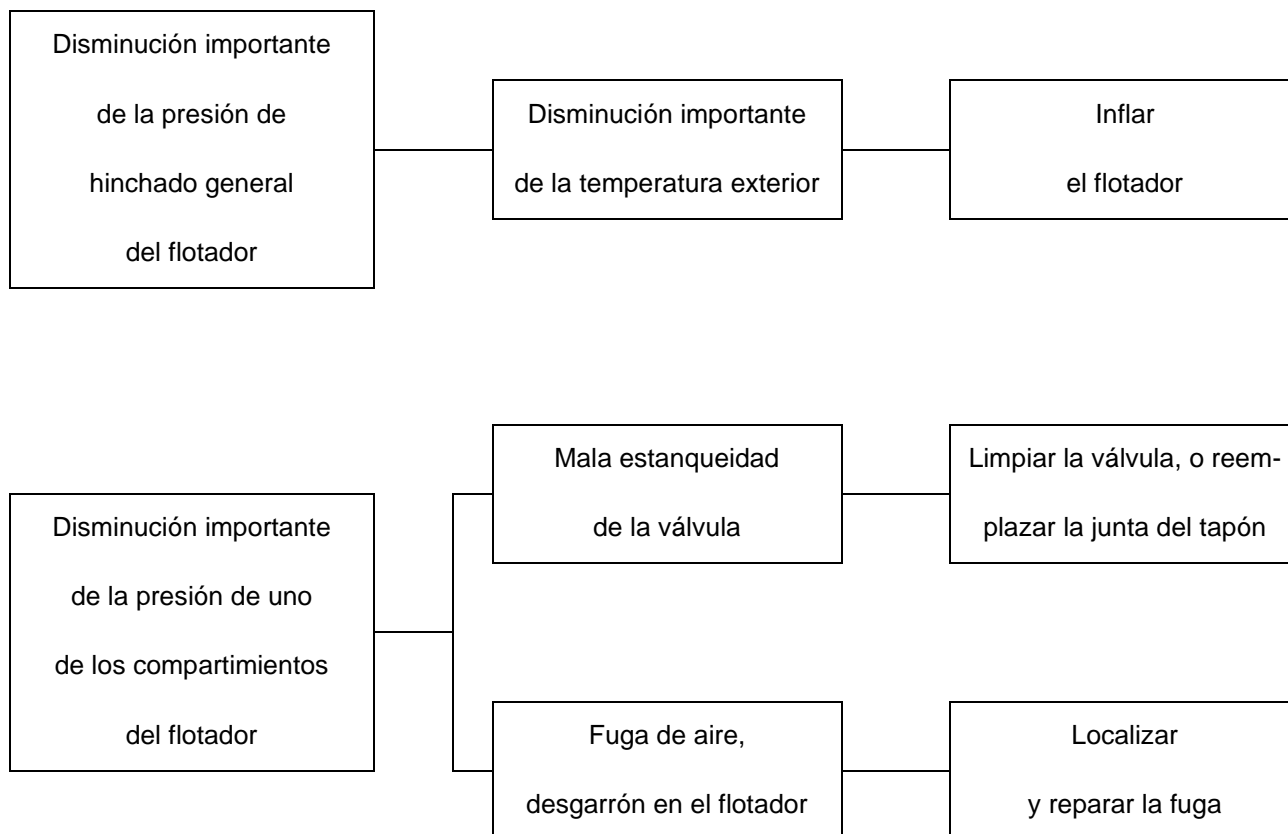

CONDICIONES GENERALES DE LA GARANTÍA

NOTA:	<p>Asegúrese de que su agente haya inscrito correctamente su embarcación para que entre en vigor la garantía del fabricante. Él le informará de las condiciones de su aplicación.</p> <p>Cualquier reclamación en garantía deberá pasar también por su agente.</p>
--------------	--------------------------------------------------------------------------------------------------------------------------------------------------------------------------------------------------------------------------------------------------------------------

Las principales restricciones para la aplicación de la garantía son las siguientes:

- La embarcación no debe haber sido transformada, modificada, sobremotorizada ni utilizada fuera del ámbito de su utilización (competiciones, usos profesionales).
- No deberá haberse sobrepasado el peso máximo de carga.
- Deberán haberse respetado las presiones de inflado, los procedimientos de montaje/desmontaje y de manipulación.
- No se deberán haber descuidado el mantenimiento y las condiciones de almacenaje.
- Esta garantía no se aplica a los elementos no suministrados por el constructor, ni a defectos derivados del montaje de dichos elementos.

 ADVERTENCIA	<p>Su embarcación ha sido diseñada conforme a las normas y para una utilización específica. Las modificaciones, transformaciones o sobremotorizaciones efectuadas con el fin de modificar sus prestaciones, suponen un riesgo grave para el usuario y conlleva la anulación de la garantía.</p>
-----------------------------------------------------------------------------------------------------------	-------------------------------------------------------------------------------------------------------------------------------------------------------------------------------------------------------------------------------------------------------------------------------------------------

NOTA:	<p>Las reparaciones en garantía serán atendidas exclusivamente por nuestra red de servicios post venta</p>
--------------	------------------------------------------------------------------------------------------------------------

**Z NAUTIC
2 Chemin La Val Priout
31450 Ayguesvives
FRANCIA**

Manuale del proprietario

Volume 1

INFORMAZIONI GENERALI-PRECAUZIONI-SICUREZZA

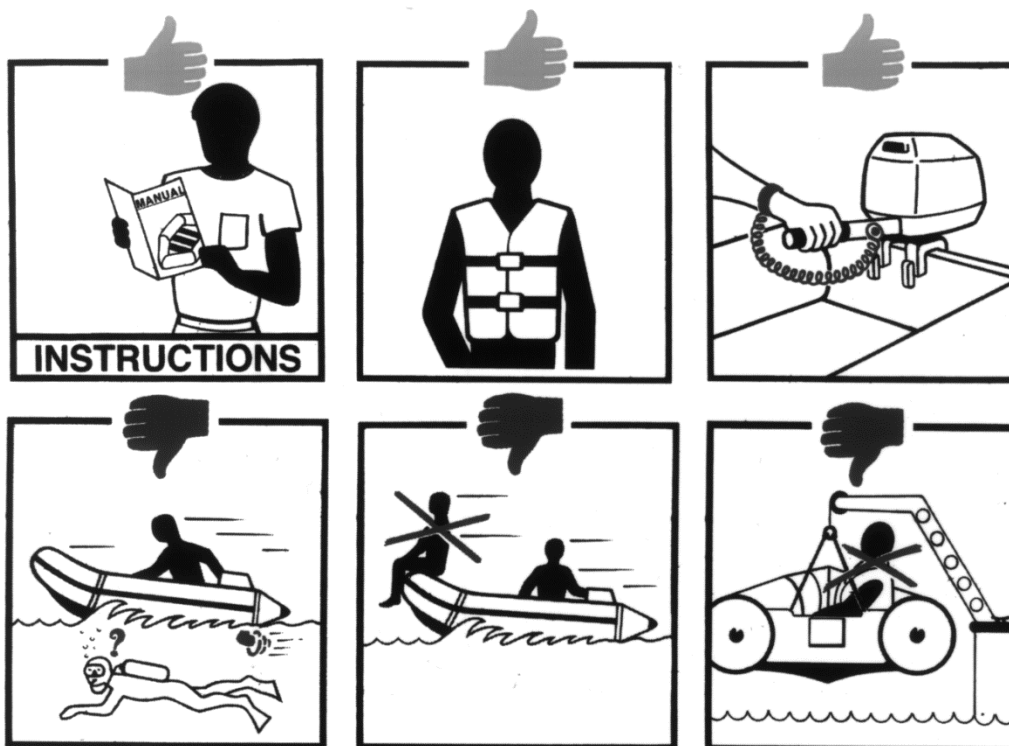

AVVERTENZA

● LEGGERE ATTENTAMENTE QUESTO MANUALE PRIMA DELLA MESSA IN SERVIZIO DELLA PROPRIA IMBARCAZIONE

● IL MANUALE DEL PROPRIETARIO SI DIVIDE IN DUE VOLUMI

<p>NOTA:</p>	<p>Il manuale del proprietario si divide in due volumi:</p> <p>Il volume 1</p> <p>Espone in maniera generale le precauzioni d'uso e contiene le raccomandazioni da rispettare a bordo e in navigazione.</p> <p>Il volume 2</p> <p>Espone in modo particolareggiato le caratteristiche tecniche e il montaggio dell'imbarcazione e del suo equipaggiamento.</p>
---------------------	-------------------------------------------------------------------------------------------------------------------------------------------------------------------------------------------------------------------------------------------------------------------------------------------------------------------------------------------------------------------------------------

	<p>Navigare è divertente, e abbiamo fatto in modo che possiate approfittarne per lunghi anni.</p> <p>Si raccomanda di leggere attentamente questo manuale del proprietario per comprendere i consigli di navigazione e le misure di sicurezza che contiene.</p> <p>Non dimenticare: la sicurezza prima di tutto!</p>
-------------------------------------------------------------------------------------	-------------------------------------------------------------------------------------------------------------------------------------------------------------------------------------------------------------------------------------------------------------------------------------------------------------------------------------------

volume 1

GENERALITÀ - PRECAUZIONI - SICUREZZA



INDICE

	Pagina		Pagina
⇒ Segnaletica di sicurezza	2	⇒ Movimentazione	
		1. ormeggio e rimorchio	15
⇒ Messaggio importante - Validità	3	2. sollevamento - posizionamento sulla gru	15
		3. sistemazione su rimorchio stradale	16
⇒ Identificazione - Certificazione	4		
		⇒ Manutenzione	
⇒ Targa costruttore	4-6	1. pulizia	17-18
		2. svernamento - magazzinaggio	18
⇒ Scelta e regolazione del motore		3. verifiche diverse	18
1. scelta del motore	7	4. riparazioni delle piccole forature	19
2. scelta dell'elica	7	5. imbarcazioni semirigide: piccole riparazioni	19
3. installazione del motore	8		
4. regolazioni	8-9	⇒ Anomalie - cause e rimedi	20
⇒ Consigli per la navigazione	10-13	⇒ Condizioni generali di garanzia	21
⇒ Ambiente	14	⇒ Al vostro servizio	22



SEGNALETICA DI SICUREZZA

Il manuale contiene le informazioni essenziali per la protezione degli utilizzatori e del materiale. I simboli riportati di seguito forniscono le avvertenze proprie a ogni situazione.

Raccomandazioni di sicurezza

 <p>PERICOLO</p>	<p>Significa che esiste un pericolo estremamente grave che può comportare un'alta probabilità di decesso o di lesioni irreparabili se non vengono adottate misure particolari.</p>
 <p>AVVERTENZA</p>	<p>Indica l'esistenza di un pericolo che può comportare lesioni o il decesso se non vengono adottate misure opportune.</p>
 <p>ATTENZIONE</p>	<p>Ricorda che si devono adottare misure di sicurezza o attirare l'attenzione su pratiche pericolose in grado di provocare lesioni alle persone o danneggiare l'imbarcazione o i suoi componenti.</p>

RACCOMANDAZIONI GENERALI

	<p>La procedura utilizzata o il comportamento da adottare è conforme alle prescrizioni.</p>
	<p>La procedura utilizzata o il comportamento da adottare non è conforme alle prescrizioni e rischia di danneggiare gravemente il materiale o di nuocere all'ambiente.</p>
<p>NOTA:</p>	<p>Attira l'attenzione su indicazioni importanti.</p>

MESSAGGIO IMPORTANTE

Siete diventati proprietari di un'imbarcazione pneumatica o semirigida. Vi ringraziamo della vostra fiducia e vi consigliamo di leggere attentamente questo manuale.

È stato redatto per aiutarvi a usare la vostra imbarcazione in maniera piacevole, confortevole e in tutta sicurezza. Il volume 2 contiene la descrizione dell'imbarcazione, degli equipaggiamenti forniti o installati, i metodi e le indicazioni necessarie al suo montaggio e manutenzione. Leggerlo attentamente e familiarizzare con l'imbarcazione prima di utilizzarla.

Il conduttore è responsabile del buon funzionamento dell'imbarcazione e della sicurezza dei suoi passeggeri. Se si tratta della vostra prima imbarcazione e non conoscete i nostri prodotti, per il vostro comfort e la vostra sicurezza fate un'esperienza di apprendistato corretta prima di prendere il "comando". Il rivenditore, il concessionario, il vostro club nautico o la federazione della nautica del vostro paese saranno felici di consigliarvi scuole e istruttori competenti.

 ATTENZIONE	<ul style="list-style-type: none"> • Consigliamo di tenere il manuale del proprietario a bordo dell'imbarcazione, in un luogo facilmente accessibile, per essere consultato dal conduttore. • Si consiglia inoltre di conservare le istruzioni fornite dai costruttori degli equipaggiamenti dell'imbarcazione (motore, batterie, ecc.) insieme al manuale. • Il manuale fa parte degli equipaggiamenti dell'imbarcazione e deve accompagnarla in caso di cessione o rivendita.
---------------------------------------------------------------------------------------------------------	---------------------------------------------------------------------------------------------------------------------------------------------------------------------------------------------------------------------------------------------------------------------------------------------------------------------------------------------------------------------------------------------------------------------------------------------------------------------------------------------------------------------------------------

VALIDITÀ

Per offrire ai nostri clienti prodotti con tecnologia sempre aggiornata noi ci riserviamo il diritto di modificare senza preavviso le caratteristiche e la disponibilità dei modelli delle nostre gamme.

Le informazioni fornite in questo manuale si riferiscono alle caratteristiche dell'imbarcazione al momento dell'edizione. Queste informazioni non sono in alcun caso contrattuali.

NOTA:	Il mancato rispetto delle direttive indicate in questo manuale esime il costruttore da ogni responsabilità.
--------------	--------------------------------------------------------------------------------------------------------------------

OMOLOGAZIONE/CERTIFICAZIONE/IDENTIFICAZIONE

Le nostre imbarcazioni sono conformi alla norma ISO 6185 definita dall'organizzazione internazionale per la standardizzazione. Sono inoltre conformi alla direttiva europea 2013/53/EU.

Siamo anche membri dell'Associazione dei fabbricanti dell'industria nautica degli Stati Uniti (NMMA), della Fédération des Industries Nautiques (FIN) francese e dell'Association pour la Plaisance Eco-Responsable (APER nautica da diporto) che permette ai proprietari di far smantellare gratuitamente la propria imbarcazione a fine vita immatricolata in Francia.

Per consentire l'identificazione della propria imbarcazione (assicurazioni, furto, servizio post-vendita, ecc.), riportare sulla targa (riproduzione qui sotto) le indicazioni contenute sulla targa costruttore fissata all'interno dello specchio di poppa.

Non dimenticare di annotare, in particolare, il modello (1) e il numero di serie (2) dell'imbarcazione, oltre al numero di identificazione individuale inciso sulla targhetta (11) fissata all'esterno dello specchio di poppa in prossimità del motore.

① Targa costruttore

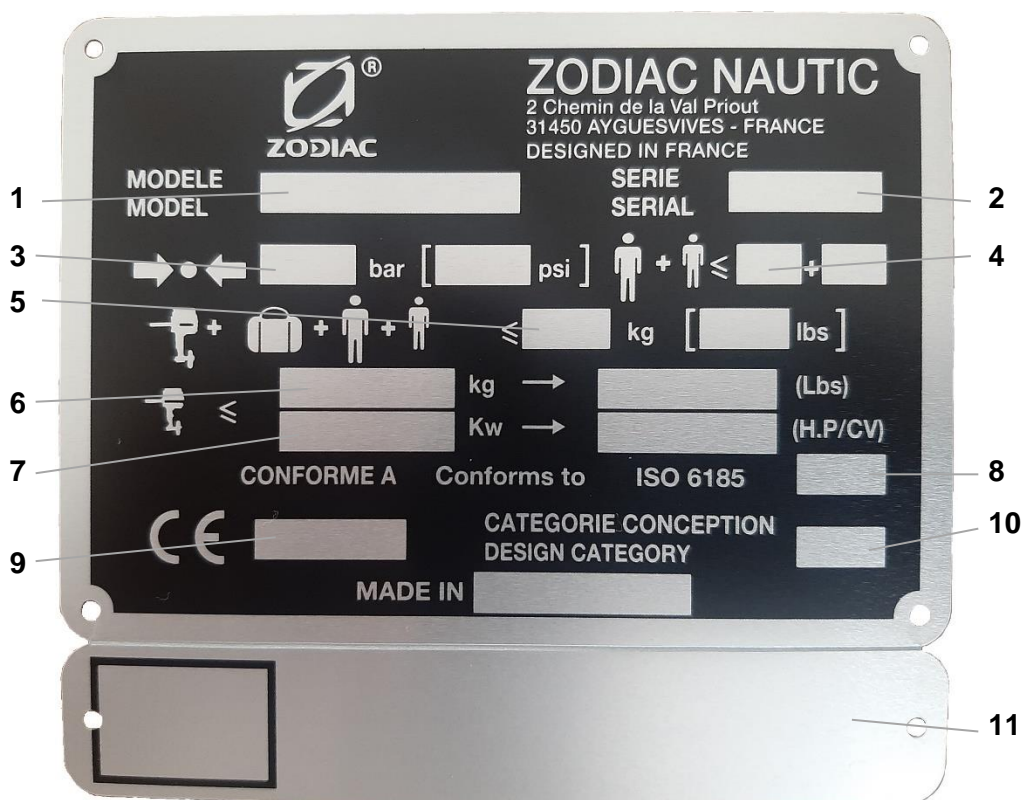

TARGA COSTRUTTORE

Le indicazioni riportate sulla targa costruttore posta sullo specchio di poppa sono molto importanti.

Esse si riferiscono principalmente ai limiti imposti dalla normativa in vigore nella maggior parte dei paesi e dal tipo di utilizzazione per il quale l'imbarcazione è stata progettata.

Le indicazioni che forniamo **non costituiscono un elenco completo**: le esigenze in materia di navigazione (dotazioni di sicurezza obbligatorie, distanza massima da un riparo ecc.) possono differire da stato a stato o anche da regione a regione. **Informarsi e conformarsi sempre ai regolamenti nazionali e locali dei paesi in cui si naviga.**

- (1) **Modello**: Nome commerciale della serie.
- (2) **Numero di serie**: identifica la serie dell'imbarcazione. Da ricordare per ogni operazione del servizio post-vendita, acquisto di pezzi di ricambio e accessori.
- (3) **Pressione di gonfiaggio** dei tubolari in Bar e PSI. Altre parti dell'imbarcazione possono avere pressioni differenti. Fate riferimento al capitolo GONFIAGGIO (VOLUME 2 del Manuale del Proprietario) o alle indicazioni riportate sulle valvole.
- (4) **Numero massimo di persone** autorizzate a bordo dell'imbarcazione in caso di equipaggiamento adatto (adulti + bambini) secondo le norme ISO.
- (5) **Carico massimo totale** autorizzato dal costruttore, espresso in chilogrammi e in libbre (persone + motore e serbatoio pieno + equipaggiamento, ossia consolle, sedili, roll bar + carichi vari, ecc.) definito conformemente alla norma ISO 14945 in vigore
- (6) **Peso massimo del motore** autorizzato per l'imbarcazione, espresso in chilogrammi e in libbre.
- (7) **Potenza massima del motore** autorizzata per l'imbarcazione in chilowatt e in cavalli (kW e CV).
- (8) **La categoria ISO**:

L'imbarcazione è conforme alla norma ISO CD 6185. La sua categoria di appartenenza è definita in funzione del range di motorizzazione.

Categoria ISO	II	V	VII
Range di motorizzazione in kW	0 - 4,5 kW	4,5 - 15 kW	>15 kW
Motorizzazione in CV	0 - 6 CV	6 - 20 CV	>20 CV

(9) **CE**: Marcatura di conformità alla direttiva europea 2013/53/EU (a partire da una lunghezza fuori tutto di 2,5 m), seguita dal numero dell'organismo di certificazione (solo per imbarcazioni di categoria di progettazione B).

(10) **La categoria di progettazione (direttiva europea 2013/53/EU)** (a partire da una lunghezza fuori tutto di 2,5 m):

In funzione della progettazione della propria imbarcazione, si è abilitati a navigare in differenti categorie:

Categoria	B	C	D
Tipo di navigazione	"Al Largo"	"In prossimità della costa"	"In acque protette"
Forza del vento (scala di Beaufort)	Fino a 8 compreso	Fino a 6 compreso	Fino a 4 compreso
Altezza significativa dell'onda (m)*	Fino a 4 compreso	Fino a 2 compreso	Fino a 0,5 compreso

**Questa rappresenta l'altezza media del terzo superiore delle onde, che corrisponde approssimativamente all'altezza dell'onda stimata da un osservatore esperto. Alcune onde avranno un'altezza doppia rispetto a questo valore.*

Alcune delle nostre imbarcazioni sono omologate per due categorie di navigazione. Per permettere l'indicazione completa delle caratteristiche relative a ogni categoria, queste hanno due targhe costruttore distinte.

(11) Targa piccola, generalmente fissata sul lato esterno dello specchio di poppa e indicante in numero individuale di identificazione dell'imbarcazione (CIN – Craft Identification Number).

 AVVERTENZA	<p>Agire responsabilmente: stabilire il proprio programma di navigazione tenendo conto di questi parametri e non prendere il mare se esiste il rischio che non vengano rispettati.</p>
--------------------------------------------------------------------------------------------------------	-----------------------------------------------------------------------------------------------------------------------------------------------------------------------------------------------

SCELTA DEL MOTORE E DELL'ELICA

1. SCELTA DEL MOTORE

1.1 Potenza del motore

- Le potenze del motore, consigliata e massima, sono riportate nella tabella delle caratteristiche dell'imbarcazione (Volume 2 del Manuale del Proprietario).
- Per le potenze ridotte, preferire i motori con comando a barra.

Sopra i 25 CV suggeriamo invece l'impiego del comando a distanza, che offre maggiore comfort e sicurezza.

 AVVERTENZA	<p>L'utilizzo di un motore con potenza superiore a quella massima autorizzata (indicata sulla targa costruttore) può causare la perdita di controllo e non è contemplato dalla normativa.</p>
----------------------------------------------------------------------------------------------------------	------------------------------------------------------------------------------------------------------------------------------------------------------------------------------------------------------

NOTA:	<p>Qualora la potenza massima consentita sia superiore alla potenza massima raccomandata, questa deve essere utilizzata con la massima prudenza. Si rivolge esclusivamente a utilizzatori sperimentati, che utilizzano l'imbarcazione in condizioni molto specifiche (trasporto di carichi pesanti ecc.).</p> <p>Consigliamo pertanto di scegliere la potenza del motore in funzione dell'utilizzo principale che verrà fatto dell'imbarcazione e di fare riferimento alla potenza suggerita (vedere volume 2).</p> <p>Con un motore troppo potente l'imbarcazione rischia di essere difficile da pilotare. Se è insufficientemente motorizzata, questa rischia invece di non possedere un margine di sicurezza sufficiente per contrastare il vento e le correnti.</p>
--------------	-------------------------------------------------------------------------------------------------------------------------------------------------------------------------------------------------------------------------------------------------------------------------------------------------------------------------------------------------------------------------------------------------------------------------------------------------------------------------------------------------------------------------------------------------------------------------------------------------------------------------------------------------------------------------------------------------------------------------------------------------------------------------

1.2 Peso del motore

Il peso del motore ha una grande incidenza sulla capacità di planata, sulla stabilità e sulle prestazioni dell'imbarcazione. A pari potenza consigliamo di scegliere il motore più leggero.

Non installare un motore di peso superiore a quello indicato sulla targa costruttore.

1.3 Tipo di albero motore

Esistono 4 tipi di albero motore: **S/L/XL/XXL**. Ciascun modello è stato progettato per l'uno o per l'altro tipo, **senza possibilità di modifica**. Verificare quale tipo di albero è adatto alla propria imbarcazione (vedere VOLUME 2).

2. SCELTA DELL'ELICA

• Per scegliere l'elica che si adatta di più al tipo di impiego, l'imbarcazione e il motore devono essere provati in acqua. Chiedere l'assistenza del proprio agente.

• L'elica fornita con il motore si presta in generale per ogni tipo di navigazione. Tuttavia, in funzione dell'utilizzo principale che si prevede di fare con l'imbarcazione, scegliere:

Un passo corto quando l'imbarcazione necessita di una forte spinta per planare (imbarcazione molto carica, sci nautico...).

Un passo lungo aumenterà il potenziale di velocità (se l'imbarcazione è poco carica).

 <p>PERICOLO</p>	<p>Qualsiasi contatto con l'elica in rotazione può causare gravi lesioni e persino la morte.</p> <p>Tenersi sempre a distanza dall'elica.</p>
------------------------------------------------------------------------------------------------------------	-------------------------------------------------------------------------------------------------------------------------------------------------------------

INSTALLAZIONE E REGOLAZIONE DEL MOTORE

3. INSTALLAZIONE DEL MOTORE

- Sistemare il motore sull'asse dell'imbarcazione, al centro della piastra di rinforzo (4).
- Serrare a mano i morsetti di fissaggio (1); alla prima installazione, controllare il serraggio dopo 15 minuti di navigazione.
- Per il serraggio dei bulloni dei motori, rivolgersi al proprio agente più vicino.
- Assicurare il motore con un cavetto (2) al ponticello (3) e ai morsetti (1).
- Tutti i motori da più di 4 CV sono dotati di un interruttore di sicurezza (5), che è essenziale alla sicurezza: assicurarli sempre al proprio polso (fare riferimento al capitolo "consigli per la navigazione).

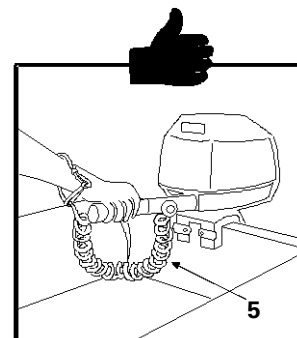
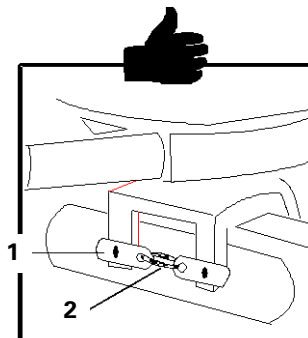
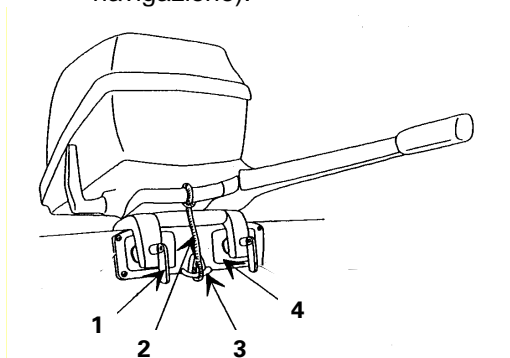

 ATTENZIONE	<ul style="list-style-type: none"> • Il serraggio dei bulloni del motore è raccomandato a partire da 10 cv ed è obbligatorio oltre i 25 cv. • A partire da 25 cv, raccomandiamo l'uso di un comando a distanza.
----------------------------------------------------------------------------------------------------------	-----------------------------------------------------------------------------------------------------------------------------------------------------------------------------------------------------------------------------------------

 AVVERTENZA	<ul style="list-style-type: none"> • Per i motori con i bulloni non serrati: verificare il corretto serraggio dei morsetti periodicamente. • Per i comandi a distanza: verificare regolarmente il loro corretto funzionamento.
----------------------------------------------------------------------------------------------------------	--------------------------------------------------------------------------------------------------------------------------------------------------------------------------------------------------------------------------------------------------------

NOTA:	<p>Il serraggio dei bulloni del motore sullo specchio si effettua dopo aver regolato il suo posizionamento. Affidare questa operazione al proprio agente.</p>
--------------	---------------------------------------------------------------------------------------------------------------------------------------------------------------

4. REGOLAZIONE

Il motore richiede una doppia regolazione di posizionamento: in altezza e in inclinazione rispetto allo specchio di poppa, che influisce direttamente e in modo molto importante sul comportamento dell'imbarcazione.

Una volta installato correttamente in altezza, il motore non avrà più bisogno di regolazioni di questo tipo. Per ottimizzare le prestazioni e assicurare la corretta manovrabilità dell'imbarcazione, potrà essere necessario modificare l'inclinazione del motore in funzione delle condizioni di navigazione (barra di regolazione o trim elettrico).

4.1. Altezza del motore

Il motore si monta direttamente sullo specchio di poppa. A seconda del marchio del motore, per uno stesso tipo di albero, la dimensione può variare di qualche centimetro. Talvolta è necessario aggiungere uno spessore di regolazione per assicurare il corretto posizionamento del motore:

Motore troppo alto = il motore va fuori giri (cavitazione)
Motore troppo basso = risalite d'acqua intempestive (fontana).

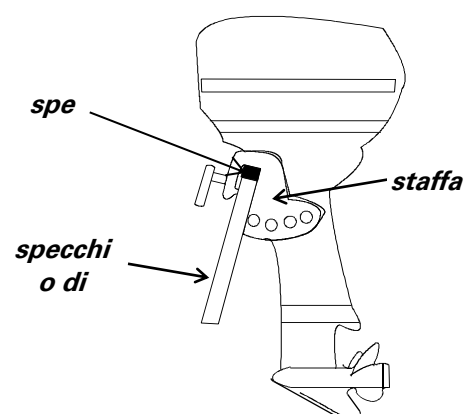

REGOLAZIONE DEL MOTORE



4.2 Inclinazione del motore

In generale il motore deve presentarsi inclinato in modo che l'asse dell'elica sia parallelo alla superficie dell'acqua.

Tuttavia in alcune situazioni può rendersi necessaria una diversa regolazione dell'inclinazione (vedere il capitolo CONSIGLI PER LA NAVIGAZIONE).

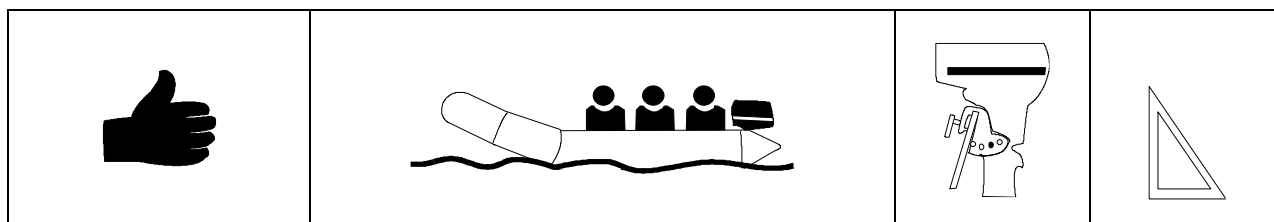
La regolazione dell'inclinazione si può effettuare tanto manualmente quanto con il Trim nei motori che sono dotati di questo dispositivo.

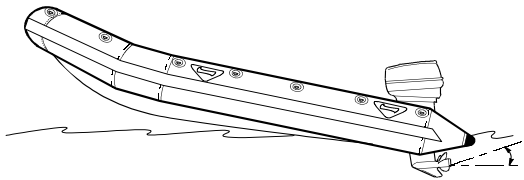

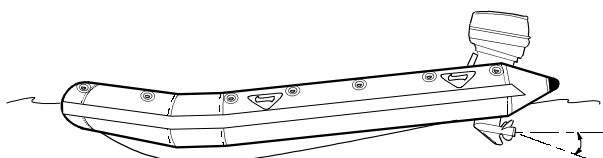
	<p>Motore troppo distante dallo specchio: L'imbarcazione si appoppa.</p> 
	<p>Motore troppo vicino allo specchio: L'imbarcazione si apprua.</p> 

 AVVERTENZA	<p>Se la regolazione dell'inclinazione del motore è manuale, spegnerlo prima di effettuare le modifiche.</p>
--------------------------------------------------------------------------------------------------------	---------------------------------------------------------------------------------------------------------------------

NOTA:	<p>Per le informazioni relative al motore fare riferimento al libretto del costruttore del motore.</p>
--------------	--------------------------------------------------------------------------------------------------------

CONSIGLI PER LA NAVIGAZIONE

Ripartizione del carico:

- Ripartire i carichi in modo equilibrato. (Per esempio, fissare il serbatoio a prua può aiutare a compensare il peso del motore a poppa).
- Durante il comando a barra, il pilota deve essere posizionato a tribordo

Esempio di buona ripartizione del carico:

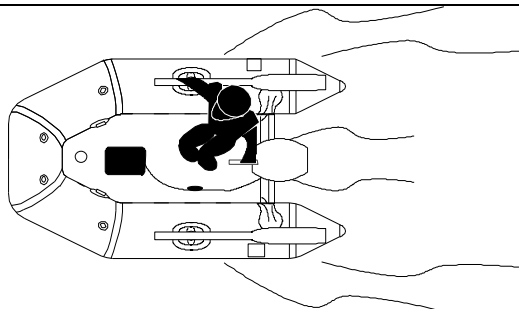

ATTENZIONE

Un'errata ripartizione del carico a bordo può destabilizzare l'imbarcazione e influire sul suo comportamento in mare.



ATTENZIONE

Quando l'imbarcazione è poco carica, reagisce in modo molto sensibile. Prestare particolare attenzione durante le accelerazioni e i cambiamenti di rotta.

In particolari condizioni di navigazione e di moto ondosso può essere necessario apportare delle modifiche alla ripartizione del carico e all'inclinazione del motore:

Mare forte di prua

Caricare l'imbarcazione a prua e, se necessario regolare la barra di inclinazione del motore

sul 1° o 2° foro.

TRIM negativo

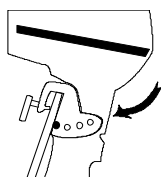

Mare forte di poppa

Caricare l'imbarcazione sulla poppa e, se necessario, regolare la barra di inclinazione del motore

sul 3° o 4° foro.

TRIM positivo

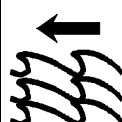
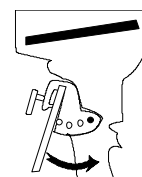

ATTENZIONE

Non far navigare l'imbarcazione con una regolazione dell'assetto negativa (prua bassa) a velocità elevata. Questo può far sbandare l'imbarcazione e può causare un'instabilità nelle virate. Usare un assetto negativo per passare dalla velocità di spostamento a quella di idroplanaggio e a velocità inferiori in caso di maretta (se il motore dispone di un trim elettrico).

CONSIGLI PER LA NAVIGAZIONE

LA SICUREZZA PRIMA DI TUTTO: Saper prevenire i rischi di incidente

VERIFICHE PRIMA DELLA PARTENZA

 <p>AVVERTENZA</p>	<p style="text-align: center;">Informarsi e informare i passeggeri:</p> <ul style="list-style-type: none"> <input checked="" type="checkbox"/> Informarsi sui regolamenti e sugli eventuali pericoli specifici per la navigazione locale. <input checked="" type="checkbox"/> Consultare i bollettini meteorologici; informarsi sui pericoli dovuti alle condizioni climatiche, alle maree, ai venti e alle correnti e sullo stato della superficie dell'acqua. <input checked="" type="checkbox"/> Informare qualcuno a terra sulla propria destinazione e sull'ora approssimativa di ritorno. <input checked="" type="checkbox"/> Determinare l'autonomia della propria imbarcazione: la distanza che si potrà percorrere con un serbatoio pieno può variare a seconda delle condizioni del mare. Controllare di avere sempre una riserva sufficiente per poter raggiungere la riva. <input checked="" type="checkbox"/> Spiegare le operazioni di base a tutti i passeggeri. <input checked="" type="checkbox"/> Assicurarsi che almeno uno dei passeggeri sappia manovrare l'imbarcazione in caso di emergenza.
	<p style="text-align: center;">Verificare il corretto funzionamento del materiale in funzione dello stato del mare e dell'utilizzo</p> <ul style="list-style-type: none"> <input checked="" type="checkbox"/> Controllare la pressione del tubolare. <input checked="" type="checkbox"/> Controllare i passa-scafo; rimuovere il tappo di scarico rapido e controllare la chiusura dei fori di aleggìo esterni dell'imbarcazione. <input checked="" type="checkbox"/> Controllare il corretto funzionamento dell'interruttore di sicurezza. <input checked="" type="checkbox"/> Controllare il corretto fissaggio del motore sullo specchio di poppa. <input checked="" type="checkbox"/> Verificare e pulire il filtro della benzina se presente. <input checked="" type="checkbox"/> Controllare la quantità di carburante disponibile. <input checked="" type="checkbox"/> Rabboccare l'olio lubrificante se il motore è dotato di serbatoio dell'olio separato. <input checked="" type="checkbox"/> Fissare il serbatoio alla sede definita. Controllare il fissaggio di tutti gli elementi mobili. <input checked="" type="checkbox"/> Verificare che il motore sia in folle prima di avviarlo.

	<p style="text-align: center;">MATERIALE DA IMBARCARE: (Fare riferimento ai regolamenti in vigore nel proprio paese).</p> <p><input checked="" type="checkbox"/> Un giubbotto di salvataggio per ogni persona a bordo, adatto alla morfologia della persona e alla zona di navigazione.</p> <p><input checked="" type="checkbox"/> Pompa, pagaie (o remi), il kit riparazioni, gli utensili per il motore.</p> <p><input checked="" type="checkbox"/> Il materiale di sicurezza obbligatorio.</p> <p><input checked="" type="checkbox"/> I documenti dell'imbarcazione e la patente.</p> <p><input checked="" type="checkbox"/> Oltre alle luci di navigazione regolamentari, è sempre prudente tenere a bordo una torcia elettrica in caso di navigazione notturna.</p>
--	-------------------------------------------------------------------------------------------------------------------------------------------------------------------------------------------------------------------------------------------------------------------------------------------------------------------------------------------------------------------------------------------------------------------------------------------------------------------------------------------------------------------------------------------------------------------------------------------------------------------------------------------------------------------------------------------------------------------------------------------------------------------------------------

CONSIGLI PER LA NAVIGAZIONE**LA SICUREZZA PRIMA DI TUTTO: SAPER PREVENIRE I RISCHI DI INCIDENTE****REGOLE DA OSSERVARE IN NAVIGAZIONE**

- Tenere sempre un comportamento responsabile, non mettere a rischio la propria vita e quella degli altri con il mancato rispetto delle regole di sicurezza.
- Osservare le regole di priorità, come quelle definite dalle norme di governo e manovra e imposte da COLREG (Regolamento Internazionale per Prevenire gli Abbordi in Mare – RIPAM)
- Assicurarsi di avere sempre una distanza sufficiente per arrestarsi o effettuare manovre, se necessario, al fine di evitare una collisione.
- Non navigare alla massima velocità in zone di intenso traffico, in caso di visibilità ridotta, di venti forti o di onde alte.
- Ridurre la velocità e la scia dell'imbarcazione, come cortesia e come misura di sicurezza per sé stessi e gli altri. Rispettare le zone di limitazione della velocità e della scia.
- Essere sempre in grado di gestire l'imbarcazione e adottare una sorveglianza costante durante la navigazione.
- Agire sempre con rispetto e cortesia.
- Osservare i regolamenti in vigore nella zona di navigazione.
- In prossimità della riva navigare solo nei canali contrassegnati.
- In mare, le condizioni del tempo possono peggiorare rapidamente. Controllare di essere sempre in grado di raggiungere la riva o un riparo se necessario.

**ATTENZIONE****PRESTARE ATTENZIONE AI VENTI E ALLE CORRENTI CHE
PORTANO VERSO IL LARGO!**



AVVERTENZA

GIUBBOTTI DI SALVATAGGIO: suggeriamo di indossare sempre il giubbotto di salvataggio durante la navigazione, facendolo indossare senza eccezioni ai bambini e ai non nuotatori.

INTERRUTTORE DI SICUREZZA: allacciare sempre l'interruttore di sicurezza al proprio polso, oppure a una parte fissa dei propri abiti. Prendere tutte le precauzioni al fine di evitare lo scatto intempestivo dell'interruttore, che comporterebbe una perdita di controllo pericolosa durante una manovra.

NIENTE ALCOL O DROGA: non pilotare dopo aver consumato alcool o droghe. Verificare anche la sobrietà dei passeggeri

Non superare mai i valori autorizzati di passeggeri, di potenza o di peso.

VERIFICARE CHE I PASSEGGERI non siano mai a prua con le gambe verso l'esterno. In caso di caduta la persona in acqua si trova sulla rotta dell'elica.

Verificare che i passeggeri siano in posizione sicura, evitare qualsiasi modifica di rotta improvvisa, salvo in caso di assoluta necessità.

Ridurre la velocità in caso di onde, per la comodità e la sicurezza degli occupanti.

In tutti i casi, avvisare i passeggeri prima della manovra.

EVITARE LE VIRATE STRETTE A ELEVATA VELOCITÀ: Si rischia di cadere e di far cadere i passeggeri.

PRESTARE PARTICOLARE ATTENZIONE AL MOMENTO DELL'ACCOSTO: Le braccia o le gambe si possono ferire se tenute all'esterno durante la manovra.

NON DIMENTICARE CHE L'ELICA RAPPRESENTA UN PERICOLO PER I BAGNANTI E PER I SUB:

Non autorizzare i passeggeri a fare il bagno quando il motore è acceso e prestare particolare attenzione quando si naviga in una zona di balneazione.

Il pallone con bandiera Alfa indica la presenza di sub: è obbligatorio tenersi lontani (almeno 100 metri).

Non lasciare mai l'imbarcazione senza aver effettuato l'ormeggio o l'ancoraggio.

CONSIGLI PER LA NAVIGAZIONE

LA SICUREZZA PRIMA DI TUTTO: Saper prevenire i rischi di incidente

Regole da osservare durante la navigazione (continuazione)

**AVVERTENZA**

- PRESTARE ATTENZIONE:** Evitare ogni contatto con oggetti taglienti o liquidi aggressivi (come l'acido).
- ATTENZIONE ALLA BATTERIA:** Fare attenzione alle scariche elettriche e all'acido che contiene.
- PREVENIRE I RISCHI DI ESPLOSIONE O D'INCENDIO:** Scegliere con cura il sistema di alimentazione del carburante e tenerlo sempre in buone condizioni.
- EVITARE DI FUMARE A BORDO** durante il riempimento del serbatoio di carburante.
- In caso di spandimento di benzina sul fondo dell'imbarcazione, sciacquare con abbondante acqua.**

IN CASO DI INCIDENTE

In caso di incidente non farsi prendere dal panico e assicurare i passeggeri. L'imbarcazione, anche se danneggiata, resta sempre il miglior sostegno e faciliterà il soccorso. Non tentare di raggiungere la riva a nuoto.

Un'imbarcazione pneumatica è praticamente insommergibile, anche se è piena d'acqua. Se si sgonfiasse un compartimento, recarsi verso l'interno dell'imbarcazione, riequilibrare il carico dalla parte opposta del compartimento sgonfio e rientrare a velocità ridotta.

In caso di collisione o di urto con un oggetto affiorante fermarsi per esaminare il fondo (lo scafo per le imbarcazioni semirigide), i tubolari, il motore e i suoi dispositivi di fissaggio prima di rientrare a velocità ridotta.

Prima di uscire di nuovo portare l'imbarcazione dal concessionario che provvederà a controllarla minuziosamente.



**ATTENZIONE**

Una negligenza nell'esame dei danni e la mancata riparazione che ciò implica riducono la resistenza e la durata di vita dell'imbarcazione e possono causare incidenti.

AMBIENTE

Per una navigazione responsabile

L'imbarcazione permetterà di scoprire la bellezza e la ricchezza dell'ambiente marino, che invitiamo a rispettare applicando queste regole di base:

	<ul style="list-style-type: none"> <input checked="" type="checkbox"/> Rispettare la vita degli animali marini. <input checked="" type="checkbox"/> Informarsi sui regolamenti internazionali contro l'inquinamento marino (MARPOL) e rispettarli il più possibile. <input checked="" type="checkbox"/> Restare informati sui regolamenti locali in materia di rispetto dell'ambiente e attenersi ai codici di buona pratica. <input checked="" type="checkbox"/> Se l'imbarcazione ne è dotata, non scaricare le toilette o il contenuto dei serbatoi di stoccaggio vicino alle coste o nelle zone vietate. Usare il sistema di pompaggio dei porti. <input checked="" type="checkbox"/> Usare vernici (antifouling) e agenti pulenti non inquinanti. <input checked="" type="checkbox"/> Tenersi distanti dalle zone riservate ai bagnanti. <input checked="" type="checkbox"/> Limitare i rumori: rispettare gli altri, evitare i rumori eccessivi e le emissioni di gas di scarico. <input checked="" type="checkbox"/> Prestare attenzione durante il riempimento del serbatoio di carburante. Il carburante in eccesso raccolto nella vasca di raccolta deve essere attentamente asciugato e gettato in un contenitore adatto per evitare qualsiasi fuoriuscita accidentale in mare.
	<ul style="list-style-type: none"> <input checked="" type="checkbox"/> Non disperdere idrocarburi (oli e carburanti) nella natura. <input checked="" type="checkbox"/> Non gettare in acqua i propri rifiuti e i sacchi della spazzatura. <input checked="" type="checkbox"/> Non provocare onde o scie che disturbano le persone a riva.

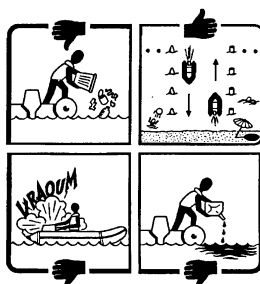

MOVIMENTAZIONE

1. ORMEGGIO E RIMORCHIO

1.1 Ormeggio

Imbarcazioni pieghevoli: usare gli anelli laterali del tubolare.

Imbarcazioni semirigide: utilizzare l'anello posto a prua.

NOTA:

In caso di ormeggio prolungato è possibile aprire lo scarico rapido per permettere lo scarico dell'acqua in caso di piogge abbondanti.



1.2 Rimorchio

Per rimorchiare l'imbarcazione pieghevole in navigazione, usare un ormeggio passato a "V" nei due anelli laterali del tubolare previsti a questo scopo. Per le imbarcazioni semirigide, fissare direttamente al golfare del dritto di prua dello scafo.

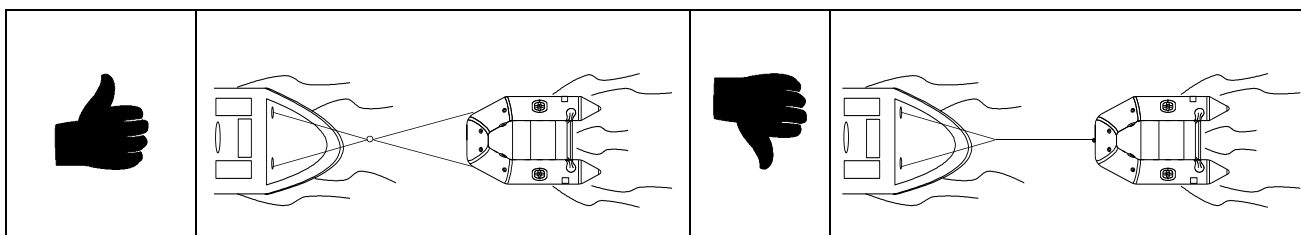
Rimorchio delle imbarcazioni pieghevoli:



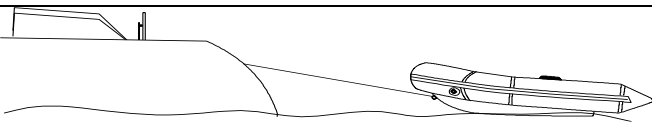

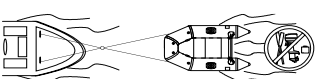
Rimorchio delle imbarcazioni semirigide:

Usare il golfare del dritto di prua		
Scaricare l'imbarcazione (sacchi, serbatoio, motore, remi) prima di rimorchiarla.		

NOTA:

Il rimorchio si deve effettuare a bassa velocità e in condizioni meteorologiche favorevoli (mare calmo e vento debole).

 ATTENZIONE	<p>I punti di ancoraggio che presentano segni visibili di deterioramento devono essere sostituiti. Devono quindi essere oggetto di un controllo regolare.</p>
 ATTENZIONE	<p>Un cavo di rimorchio deve essere sempre fissato in modo da poter essere mollato sotto carico.</p>
NOTA:	<p>Assicurarsi che le corde di ormeggio, i cavi di rimorchio, le catene e le linee di ancoraggio, così come le ancore, siano adeguati all'uso previsto dell'imbarcazione. In particolare, le linee o le catene non devono superare l'80% della resistenza alla rottura del punto di ancoraggio corrispondente (vedere Volume 2). Se necessario, chiedere l'assistenza del proprio agente.</p>

1.3 Ormeggio al pontile

L'imbarcazione può essere ormeggiata al pontile con almeno due tipi di ormeggio chiamati ormeggi di punta: Uno di prua, l'altro di poppa.

L'ormeggio può essere fissato a un punto fisso e abbastanza solido dell'imbarcazione:

Imbarcazioni semirigide: Galloccia, golfare di prua, bitta di ormeggio, lande dello specchio di poppa (non usare i punti non previsti a tale scopo: Ralinga, maniglia, pulpito, tientibene, anello piccolo del tubolare, ecc.)

- Imbarcazioni pieghevoli e annessi: Galloccia, lande di specchio, anello di rimorchio, maniglia anteriore (non usare i punti non previsti a questo scopo: Ralinga, maniglia per il trasporto, anello piccolo del tubolare, ecc.)



L'imbarcazione deve essere assolutamente protetta dallo sfregamento contro il pontile usando parabordi.

Gli ormeggi non devono sfregare contro il tubolare. Se il pontile ha una configurazione non adatta, il tubolare dovrà essere protetto al livello delle zone di sfregamento (tela spessa o ormeggio inserito in un tubo di gomma, per esempio).

Ogni imbarcazione ormeggiata ad un pontile deve essere regolarmente controllata. Ci sarà da rinforzare eventualmente l'ormeggio secondo le condizioni meteorologiche.

2. SOLLEVAMENTO- POSIZIONAMENTO SULLA GRU

Per il sollevamento o per il posizionamento sulla gru utilizzare gli appositi anelli. Se l'imbarcazione non ne fosse dotata (vedere Volume 2), farli applicare dal proprio agente.

 AVVERTENZA	Nessun passeggero a bordo durante il gruaggio
 ATTENZIONE	<p>In caso di gruaggio o di posizionamento sulla gru, tutto il materiale deve essere scaricato dall'imbarcazione.</p> <p>Gli scarichi rapidi devono essere aperti e l'imbarcazione deve essere inclinata sulla poppa per assicurare l'eventuale scarico dell'acqua.</p>

MOVIMENTAZIONE

3. SISTEMAZIONE SU RIMORCHIO STRADALE

- L'imbarcazione deve essere correttamente gonfiata.
- Gli scarichi rapidi devono essere aperti.

3.1 Imbarcazioni pieghevoli:

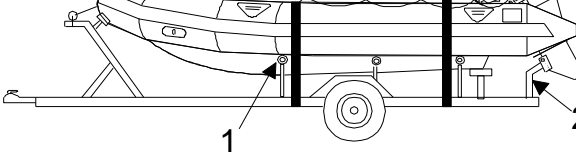
- Regolare i rulli (1) del rimorchio in modo che sostengano i tubolari da ciascun lato e a poppa.
 - Issare l'imbarcazione dalla prua, utilizzando gli anelli laterali.
 - La parte inferiore dello specchio di poppa deve poggiare sul rimorchio.
- 
- Sistemare il motore in posizione di navigazione facendolo poggiare su un sostegno opportunamente applicato al rimorchio (2).
 - Assicurarsi che l'imbarcazione sia ben fissata e posizionata orizzontalmente.
 - Rimuovere/fissare tutto il materiale che può volare via
 - Se necessario, assicurare il posizionamento con degli spessori e serrare fortemente le cinghie inserendo delle protezioni sui tubolari per evitare l'attrito (4).

3.2 Imbarcazioni semirigide:

- Regolare i rulli della parte centrale in modo che tutto il peso dell'imbarcazione sia appoggiato a questi.
- Regolare i rulli o i pattini laterali in modo da stabilizzare l'imbarcazione (attenzione al di fuori del fasciame o redan)
- Regolare la distanza della testina di aggancio in modo che lo specchio sia appoggiato sull'ultimo rullo centrale.
- Sistemare il motore in posizione di navigazione facendolo poggiare su un sostegno opportunamente applicato al rimorchio (3).
- Usare gli anelli di rimorchio e il golfare del dritto di prua (per le imbarcazioni che ne sono dotate) per fissare saldamente lo scafo sul rimorchio

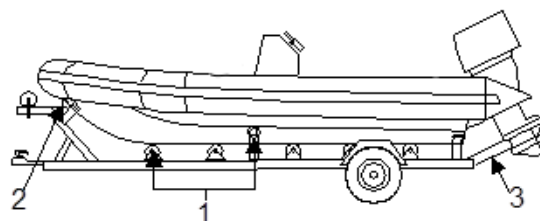

Rimuovere o fissare il materiale che può volare via, inclusi gli accessori e le parti amovibili.

Per ragioni di sicurezza stradale è necessario coprire l'elica con una protezione efficace.

 <p>ATTENZIONE</p>	<ul style="list-style-type: none"> • Il posizionamento scorretto dell'imbarcazione sul rimorchio rischia di provocare deformazioni irrimediabili, che possono causare difetti di funzionamento. • Non superare mai il peso massimo autorizzato dal rimorchio.
--------------------------------------------------------------------------------------------------------------	---------------------------------------------------------------------------------------------------------------------------------------------------------------------------------------------------------------------------------------------------------------------------------------

 <p>AVVERTENZA</p>	<p>SU STRADA:</p> <ul style="list-style-type: none"> • Scaricare sempre tutto il materiale non saldamente fissato dall'imbarcazione prima di rimorchiarla. • Nessun passeggero a bordo durante il trasporto su rimorchio.
--------------------------------------------------------------------------------------------------------------	----------------------------------------------------------------------------------------------------------------------------------------------------------------------------------------------------------------------------------------------------------

MANUTENZIONE

Il tubolare della propria imbarcazione è realizzato in tessuto imputrescibile. Richiede una manutenzione semplice ma indispensabile per garantire la massima durata dell'imbarcazione.

1. PULIZIA

Pulire l'imbarcazione regolarmente e di frequente. Sempre, prima di ogni svernamento.

È fondamentale pulire l'imbarcazione regolarmente, in particolare il tubolare. È anche possibile affidare questo compito al proprio agente, che dispone dei prodotti e dell'esperienza necessari per realizzare una pulizia meticolosa, che prolungherà la durata di vita dell'imbarcazione.



**NON USARE DISPOSITIVI DI PULIZIA
AD ALTA PRESSIONE SUI TESSUTI**

1.1 Pulizia del tubolare

A tubolari gonfi:

- Aprire lo scarico rapido e sciacquare l'imbarcazione con un getto d'acqua dolce per asportare la sabbia e i detriti.
- Pulire regolarmente il tubolare con **acqua dolce e sapone**, almeno una volta al mese durante il periodo di utilizzo.
- Rimuovere le tracce di catrame (per le macchie resistenti, usare il prodotto disponibile presso il proprio agente).
- Controllare i tubolari con acqua e sapone per individuare eventuali piccole perdite.
- Risciacquare con acqua dolce e lasciare asciugare.



Non usare detergenti aggressivi (acido, tricloro, benzina, acetone) o prodotti a base di silicone. In caso di versamento sul tubolare, sciacquare subito con abbondante acqua.

Al momento dello sgonfiaggio:

- Verificare il buono stato e la pulizia delle valvole e delle loro guarnizioni (tenuta, sabbia ecc.).
- Verificare che lo scarico rapido non sia ostruito.

1.2 Controllare la tenuta dei tubolari:

NOTA:	<p>Con l'indicatore di pressione (fornito con certi modelli o disponibile presso il proprio agente) misurare la perdita di pressione dopo 24 ore.</p> <p>CALI DI PRESSIONE:</p> <ul style="list-style-type: none"> • È normale rilevare un calo di pressione fino al 20% in 24 ore. <p>(Norma ISO CD 6185). Se si notano dei cali di pressione superiori a:</p> <p style="padding-left: 40px;">0,145 PSI (0,010 Bar)/5 ore per il tubolare</p> <p style="padding-left: 40px;">0,5 PSI (0,035 Bar)/5 ore per il fondo gonfiabile ad alta pressione</p> <p>verificare la tenuta.</p> <ul style="list-style-type: none"> • La temperatura influenza fortemente la pressione. Una variazione di 1°C causa una variazione nello stesso senso prossima a 0,06 PSI (0,004 Bar = 4 millibar). <p>Ogni calo di pressione anomalo richiede una verifica attenta delle valvole e delle loro guarnizioni. Chiedere consulenza al proprio agente.</p>
--------------	-------------------------------------------------------------------------------------------------------------------------------------------------------------------------------------------------------------------------------------------------------------------------------------------------------------------------------------------------------------------------------------------------------------------------------------------------------------------------------------------------------------------------------------------------------------------------------------------------------------------------------------------------------------------------------------------------------------------------------------------------------------------------------------------------------------------------------------------------------------------------------------------------------------------------------------------------------------------------------

1.3 Operazione supplementare per le imbarcazioni semirigide: pulizia dello scafo:

- Rimuovere i tubolari (per le imbarcazioni con tubolare amovibile).
- Lavare la coperta e la carena con acqua e sapone, sciacquare con acqua dolce e lasciare asciugare.
- Verificare che lo scarico rapido non sia ostruito.
- Togliere il tappo dal foro di alleggio per svuotare l'acqua eventualmente contenuta nello scafo.
- Rimontare il tubolare se del caso.

MANUTENZIONE

1.4 Manutenzione delle parti in inox

Selezioniamo acciai inox di grande qualità con elevata resistenza alla corrosione. Essi, tuttavia, sono sottoposti nell'ambiente marino all'aggressione combinata del sale e dell'acqua.

NOTA:	<p>Un acciaio inox non è inalterabile e richiede un minimo di precauzioni e di manutenzione:</p> <ul style="list-style-type: none"> • Evitare di contaminarlo a contatto con strumenti ferrosi: Usare strumenti cromati. • Evitare di rigare la superficie. • Risciacquare di frequente con acqua dolce. • Se necessario, ripristinare la pellicola protettiva con una pasta passivante (rivolgersi al proprio agente).
--------------	--------------------------------------------------------------------------------------------------------------------------------------------------------------------------------------------------------------------------------------------------------------------------------------------------------------------------------------------------------------------------------------------------------------------------------------------------------------------------

1.5 Manutenzione della cuscineria e degli altri materiali

Pulire la cuscineria e il compensato marino con acqua dolce e sapone, poi asciugare.

Le vernici e le pitture non sono soltanto elementi decorativi ma hanno anche un'importante funzione protettiva. Se la superficie si scrosta o si deteriora, fare riverniciare con prodotti a base di resine poliuretaniche.

2. Svernamento - stoccaggio

Al di fuori dei periodi di utilizzazione l'imbarcazione va rimessata in un ambiente pulito e asciutto, al riparo da brusche variazioni di temperatura e dalle aggressioni degli agenti esterni.

È possibile rimessare l'imbarcazione in due modi:

- Ripiegata nella sua sacca.
- Montata e leggermente sgonfia.

	<ul style="list-style-type: none"> • in caso di rimessaggio prolungato al sole (in particolare ai tropici) proteggere l'imbarcazione con un telo della nostra gamma. • Proteggere l'imbarcazione contro i piccoli roditori (ratti, topi) che possono forare lo pneumatico. • Se si rimessa l'imbarcazione gonfiata, prestare attenzione a non sottoporla a deformazioni.
-------------------------------------------------------------------------------------	--------------------------------------------------------------------------------------------------------------------------------------------------------------------------------------------------------------------------------------------------------------------------------------------------------------------------------------------------------------------------------------------------------------------------------

3. VERIFICHE DIVERSE

- Controllare periodicamente le condizioni della timoneria, delle drizze e delle cinghie. Fare sostituire i pezzi che presentano tracce di usura.
- Controllare frequentemente il serraggio delle viti e dei dadi, in particolare il serraggio dei bulloni del motore.
- Esaminare regolarmente lo stato del sistema di alimentazione di carburante. Fare sostituire i pezzi che presentano tracce di usura o di invecchiamento. Verificare il serraggio delle fascette.

MANUTENZIONE

4. RIPARAZIONE DELLE PICCOLE FORATURE

NOTA:	<p>L'imbarcazione è fornita con il necessario per la riparazione, che deve essere a bordo.</p> <p>Le riparazioni durante la navigazione sono delicate. Rispettare il più possibile le istruzioni riportate di seguito. Al rientro a terra, ripetere le riparazioni o farle ripetere dal proprio agente.</p>
--------------	-------------------------------------------------------------------------------------------------------------------------------------------------------------------------------------------------------------------------------------------------------------------------------------------------------------

MATERIALE NECESSARIO PER LE RIPARAZIONI	<p>Per pulire:</p> <ul style="list-style-type: none"> ➤ Solvente leggero per la pulizia (acetato di etile) (non fornito) <p>Per riparare:</p> <ul style="list-style-type: none"> ➤ Pezze di tessuto. ➤ Tubo di colla o patch di riparazione messo a disposizione (Patch'n Go) ➤ Pennello - strumento per levigatura (non forniti) ➤ Scheda di istruzioni
CONDIZIONI PER UNA RIPARAZIONE DI QUALITÀ OTTIMALE	<ul style="list-style-type: none"> ➤ Tasso di umidità temperata: igrometria <60 %. ➤ Temperatura compresa tra 18 e 25°C. ➤ Riparare in un ambiente asciutto e all'ombra. ➤ Tubolare orizzontale, sgonfio.
PREPARAZIONE	<ul style="list-style-type: none"> ➤ Individuare le perdite (con acqua e sapone se la perdita non è visibile) ➤ Tagliare una pezza rotonda che sia più grande di almeno 5 cm della lacerazione del tubolare o usare una pezza adatta del materiale necessario alla riparazione. ➤ Segnare sul tubolare il preciso posizionamento della pezza. ➤ Pulire la pezza e la zona intorno alla lacerazione con solvente ➤ Lasciare asciugare per 5 minuti.
INCOLLAGGIO	<ul style="list-style-type: none"> ➤ Incollare il tubolare e la pezza, passare su ognuno 3 strati sottili di colla e lasciare asciugare 3-5 minuti tra ogni strato (la colla non deve più aderire al dito, ma non deve essere troppo asciutta).

<p>APPLICAZIONE DELLA PEZZA</p>	<ul style="list-style-type: none"> ➤ Dopo l'asciugatura dell'ultimo strato, applicare la pezza senza premere per poter correggere un eventuale posizionamento errato. ➤ Premere dal centro verso l'esterno per espellere eventuali bolle d'aria. ➤ Lisciare energicamente la pezza con un oggetto arrotondato, cominciando dal centro. ➤ Se necessario, pulire la colla in eccesso con del solvente.
<p>PRIMA DI RIUSARE L'IMBARCAZIONE</p>	<ul style="list-style-type: none"> ➤ Evitare se possibile di esporre la riparazione al sole o alla pioggia. ➤ Lasciare asciugare per 24 ore prima di procedere al rigonfiaggio.
<div style="text-align: center;">  <p>ATTENZIONE</p> </div>	<p>Non lasciare il tubetto di colla al sole, in prossimità di una fiamma o di una fonte di calore.</p> <p>Lavorare sempre in un ambiente aerato, evitare di respirare i vapori di colla, di ingerirla; evitare di portarla a contatto con la pelle.</p>

5. IMBARCAZIONI SEMIRIGIDE: RIPARAZIONE DELLE RIGATURE SULLO SCAFO

- È possibile ridurre le piccole rigature utilizzando pasta per lucidare o dell'ovatta per lucidare.
- Le rigature più profonde si possono riparare con mastice in poliестere o gelcoat di riparazione. In tal caso, chiedere consulenza al proprio agente.

<p>NOTA:</p>	<p>In caso di riparazione importante del tubolare o dello scafo, consultare il proprio agente che dispone dei prodotti, degli strumenti e dell'esperienza necessari per realizzare riparazioni di alta qualità.</p>
---------------------	---------------------------------------------------------------------------------------------------------------------------------------------------------------------------------------------------------------------

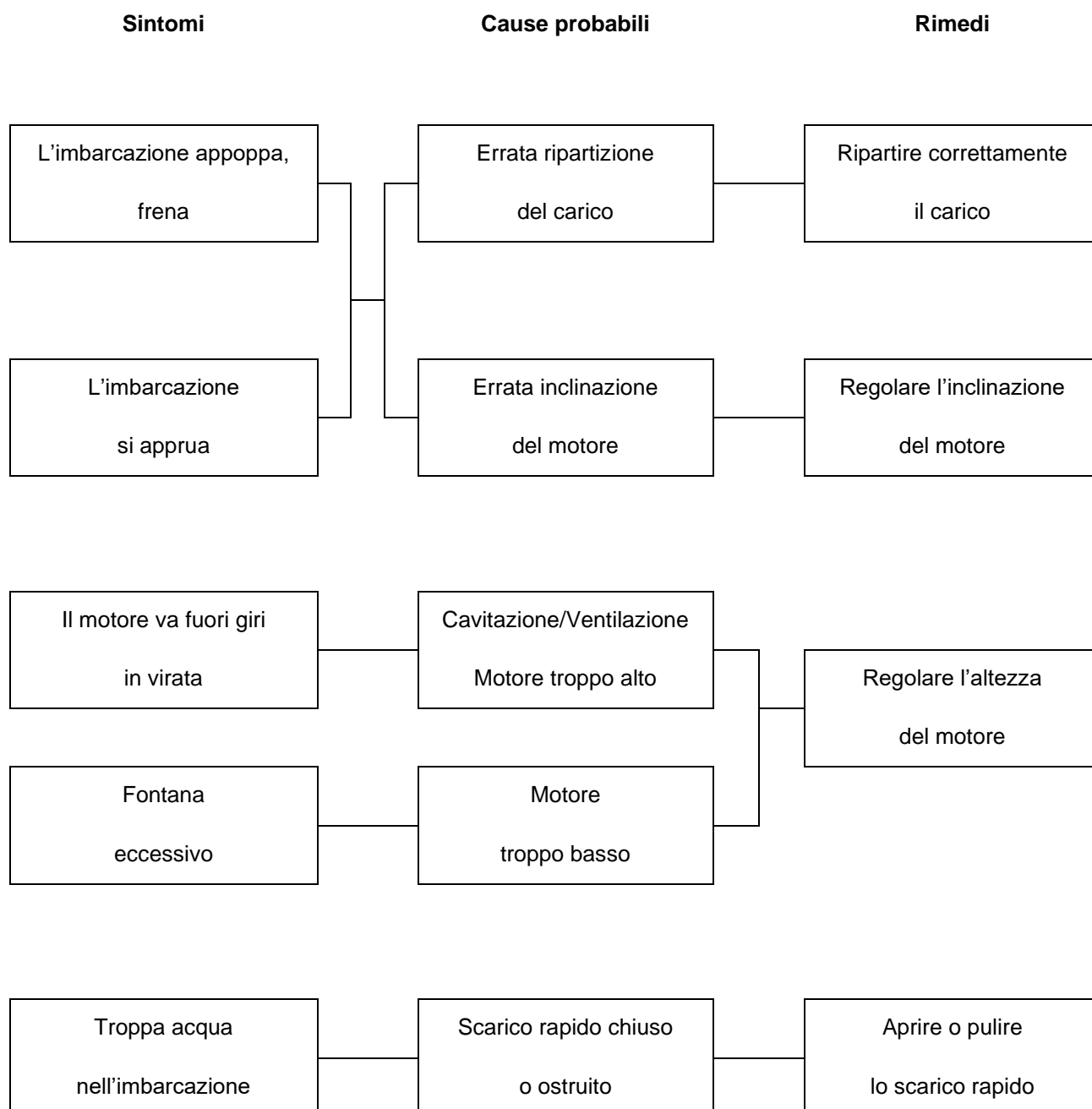
ANOMALIE: CAUSE E RIMEDI

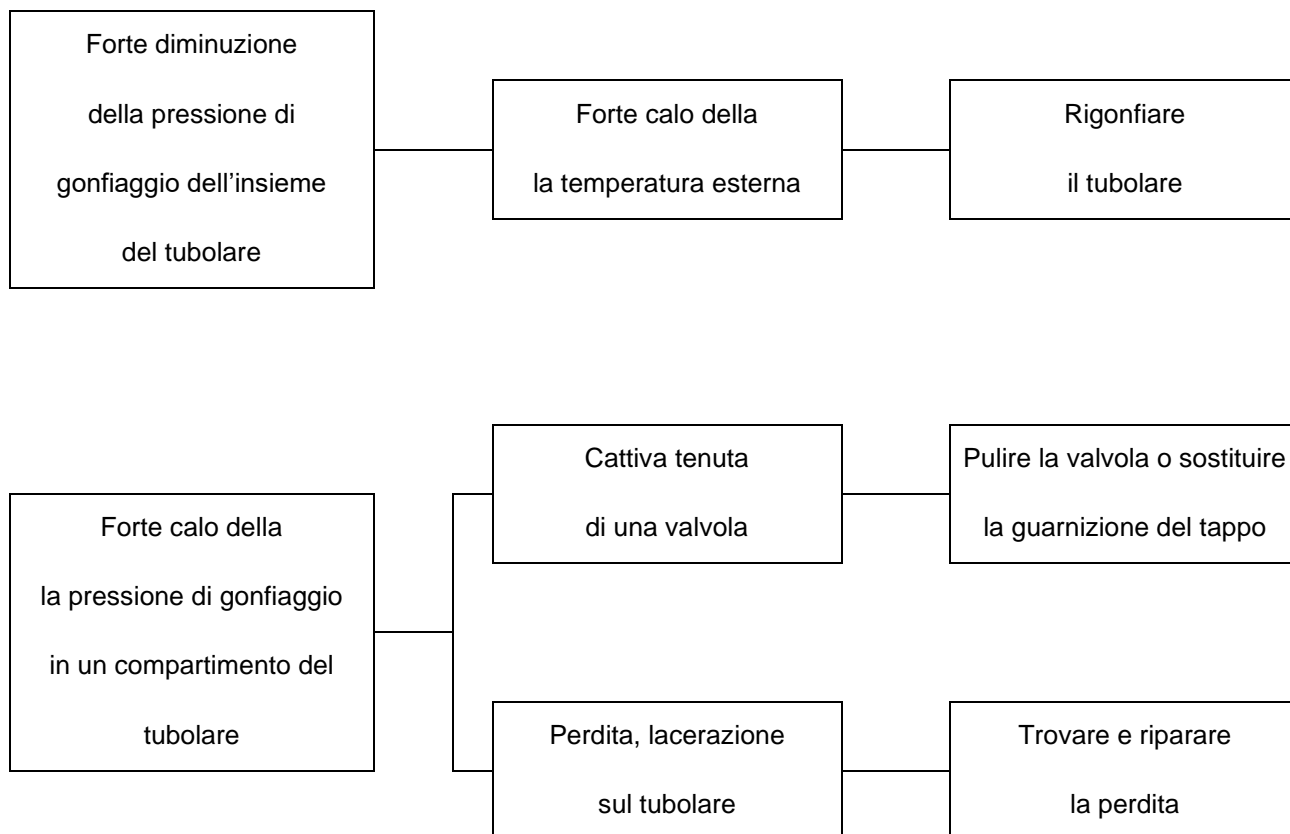

CONDIZIONI GENERALI DI GARANZIA

NOTA:	<p>Assicurarsi presso il proprio agente che abbia registrato l'imbarcazione per la garanzia del costruttore. Si riceveranno informazioni sulle condizioni della sua applicazione.</p> <p>Il ricorso alla garanzia deve avvenire tramite l'agente.</p>
--------------	---------------------------------------------------------------------------------------------------------------------------------------------------------------------------------------------------------------------------------------------------------------------

Le principali restrizioni all'applicazione della garanzia sono le seguenti:

- L'imbarcazione non dovrà essere stata trasformata, modificata, sovramotorizzata o utilizzata al di fuori del suo impiego previsto (competizioni, impieghi professionali).
- Il peso del carico massimo non deve essere stato superato.
- Le pressioni di gonfiaggio, le procedure di montaggio e smontaggio e quelle di movimentazione dovranno essere state rispettate.
- La manutenzione e le condizioni di rimessaggio non dovranno essere state trascurate.
- La presente garanzia non si applica agli elementi non forniti dal costruttore o ai difetti provocati dal montaggio di questi elementi.

 AVVERTENZA	<p>L'imbarcazione è stata progettata in conformità con la normativa vigente e per un uso specifico. Le modifiche, le trasformazioni o le sovramotorizzazioni realizzate allo scopo di modificare le prestazioni comportano rischi gravi per l'utente e implicano l'annullamento della garanzia.</p>
----------------------------------------------------------------------------------------------------------	------------------------------------------------------------------------------------------------------------------------------------------------------------------------------------------------------------------------------------------------------------------------------------------------------------

NOTA:	<p>Le riparazioni a titolo di garanzia verranno effettuate esclusivamente dalla nostra rete autorizzata.</p>
--------------	---------------------------------------------------------------------------------------------------------------------

Z NAUTIC
2 Chemin La Val Priout
31450 Ayguesvives
FRANCE

611957 - A

Eierhåndbok

Bind 1 GENERELT-FORHOLDSREGLER-SIKKERHET

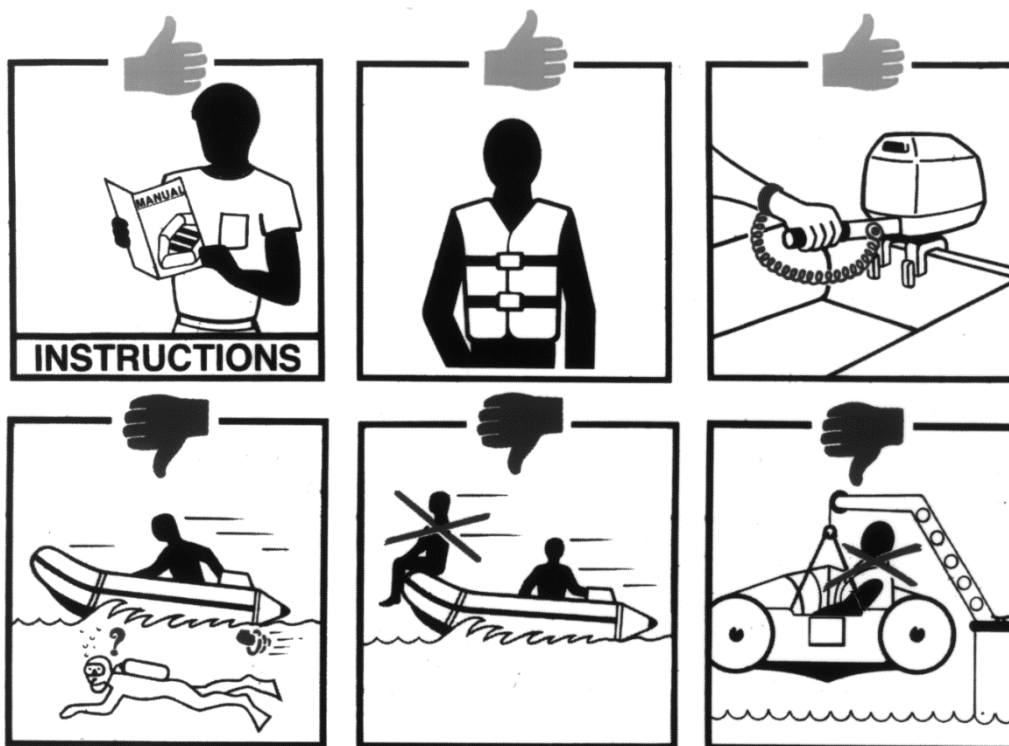

- LES DENNE EIERHÅNDBOKEN NØYE FØR DU TAR I BRUK OG SETTER BÅTEN I DRIFT
- EIERHÅNDBOKEN ER DELT I TO BIND

<p>MERK:</p>	<p>Eierhåndboken er delt i to bind:</p> <p>Bind 1</p> <p>Behandler generelt vanlige forholdsregler og anbefalinger som må respekteres ombord i båten og på vannet.</p> <p>Bind 2</p> <p>Behandler mer spesielt båtens tekniske karakteristikk og hvordan den monteres og utstyres.</p>
---------------------	-------------------------------------------------------------------------------------------------------------------------------------------------------------------------------------------------------------------------------------------------------------------------------------------------------------

	<p>Å navigere er en glede, og vi vil at du skal ha glede av navigering i mange år.</p> <p>Ta deg tid til å lese denne eierhåndboken nøye for å lære av navigasjonsrådene og sikkerhetstiltakene som beskrives i den.</p> <p>Ikke glem: sikkerheten gjelder foran alt!</p>
-------------------------------------------------------------------------------------	----------------------------------------------------------------------------------------------------------------------------------------------------------------------------------------------------------------------------------------------------------------------------------

BIND 1

GENERELT - FORHOLDSREGLER - SIKKERHET

INNHOLD



	Side		Side
⇒ Sikkerhetssymboler	2	⇒ Håndtering	
		1. ankring og sleping	15
⇒ Viktig melding - gyldighet	3	2. løfting - plassering på davit	15
		3. plassering på tilhenger	16
⇒ Identifisering - Sertifisering	4		
⇒ Merkeplate	4-6	⇒ Vedlikehold	
		1. rengjøring	17-18
⇒ Valg og innstillinger av motor		2. vinteropplag - lagring	18
1. valg av motor	7	3. diverse kontroller	18
2. valg av propell	7	4. reparasjon av små sprekker	19
3. installasjon av motoren	8	5 RIB-båter: små reparasjoner	19
4. innstillinger	8-9	⇒ Feil - årsaker / løsninger	20
⇒ Navigasjonsråd	10-13	⇒ Generelle garantibetingelser	21
⇒ Miljøet	14	⇒ Service	22

SIKKERHETSSYMBOLER



Denne håndboken inneholder opplysninger som er svært viktige for å beskytte brukerne og utstyret.

Symbolene nedenfor angir advarsler som spesifikt gjelder hver situasjon.

SIKKERHETSANBEFALINGER

 <p>FARE</p>	<p>Betyr at det finnes en ytterst alvorlig fare som med stor sannsynlighet føre til dødsfall eller uheldelige skader hvis det ikke treffes spesifikke egnede tiltak.</p>
 <p>ADVARSEL</p>	<p>Betyr at det finnes en fare som kan medføre personskade eller dødsfall hvis det ikke treffes spesifikke egnede tiltak.</p>
 <p>OBS</p>	<p>Minner om sikkerhetstiltakene eller henleder oppmerksomheten på farlige måter å gjøre ting på som kan forårsake personskade eller skade båten eller dens komponenter.</p>

GENERELLE ANBEFALINGER

	<p>Fremgangsmåten som brukes eller personers oppførsel oppfyller forskriftene.</p>
	<p>Fremgangsmåten som brukes eller personers oppførsel oppfyller ikke forskriftene og risikerer å påføre utstyret alvorlig skade eller skade miljøet.</p>
<p>MERK:</p>	<p>Henleder oppmerksomheten på viktige angivelser.</p>

VIKTIG MELDING

Du er nå eier av en gummibåt eller RIB. Takk for tilliten du viser oss. Vi anbefaler at du leser denne håndboken grundig.

Den er skrevet for å hjelpe deg med å få glede av båten, i full komfort og sikkerhet. Den inneholder, i Bind 2, en beskrivelse av båten, levert eller installert utstyr, samt arbeidsmetoder og indikasjoner som trengs for bruk og vedlikehold. Les håndboken grundig, og gjør deg fortrolig med båten før du bruker den.

Føreren er ansvarlig for at båten fungerer riktig og for passasjerenes sikkerhet. Hvis dette er din første båt eller du ikke er fortrolig med våre produkter, må du forvise deg om å ha tilstrekkelig erfaring av å ta i bruk båter før du tar ansvar som "kommandant", dette både av hensyn til sikkerhet og komfort. Din selger, din forhandler, det nasjonale båtforbundet eller din lokale båtklubb vil kunne gi deg råd om navigasjonsopplæring og kompetente instruktører.

**OBS**

- **Det anbefales å oppbevare eierhåndboken ombord på båten, på et sikkert sted som er lett tilgjengelig for føreren.**
- **DET ANBEFALES OGSÅ AT DE FORSKJELLIGE BRUKSANVISNINGENE FRA BÅTUTSTYRETS PRODUSENTER OPPBEVARES SAMMEN MED HÅNDBOKEN (motor, batterier, etc.).**
- **DENNE HÅNDBOKEN ER DEL AV BÅTENS UTSTYR OG SKAL FØLGE BÅTEN VED SALG ELLER VIDERESALG.**

GYLDIGHET

Vi gjør vårt ytterste for at våre kunder skal kunne nyte fordelene av den konstante utviklingen våre produkter er i, og forbeholder oss derfor retten til å endre karakteristikkene og tilgjengeligheten til modellene i våre serier.

Opplysningene i denne håndboken gjelder båtens karakteristikker i det øyeblikk de ble redigert. De er ikke i noe tilfelle kontraktmessig bindende.

MERK:

manglende respekt for retningslinjene i denne håndboken opphever ethvert ansvar fra produsentens side.

GODKJENNING / SERTIFISERING / IDENTIFISERING

Våre båter oppfyller kravene i standarden ISO 6185 fra Den internasjonale standardiseringsorganisasjonen. De er i overensstemmelse med det europeiske direktivet 2013/53/EU.

Vi er også medlemmer av den amerikanske National Marine Manufacturers Association (NMMA), det franske båtindustriforbundet (Fédération des Industries Nautiques (FIN)) og foreningen for øko-ansvarlig fritidsbåtbruk (Association pour la Plaisance Eco-Responsable (APER Plaisance)) som gjør det mulig for eierne å ta fra hverandre eller hugge gratis opp båter som er registrert i Frankrike etter endt levetid.

For å sikre båtens sporbarhet (forsikringer, tyveri, ettersalgsservice, osv.), noter på platen (gjengivelse nedenfor) de viktige indikasjonene som er gitt på merkeplaten som er festet på innsiden av speilhekken.

Noter spesielt båtens modell (1) og serienummer (2), samt det individuelle identifikasjonsnummeret som er gravert på den lille platen (11) festet på utsiden av speilhekken, nær motoren.

① Merkeplate

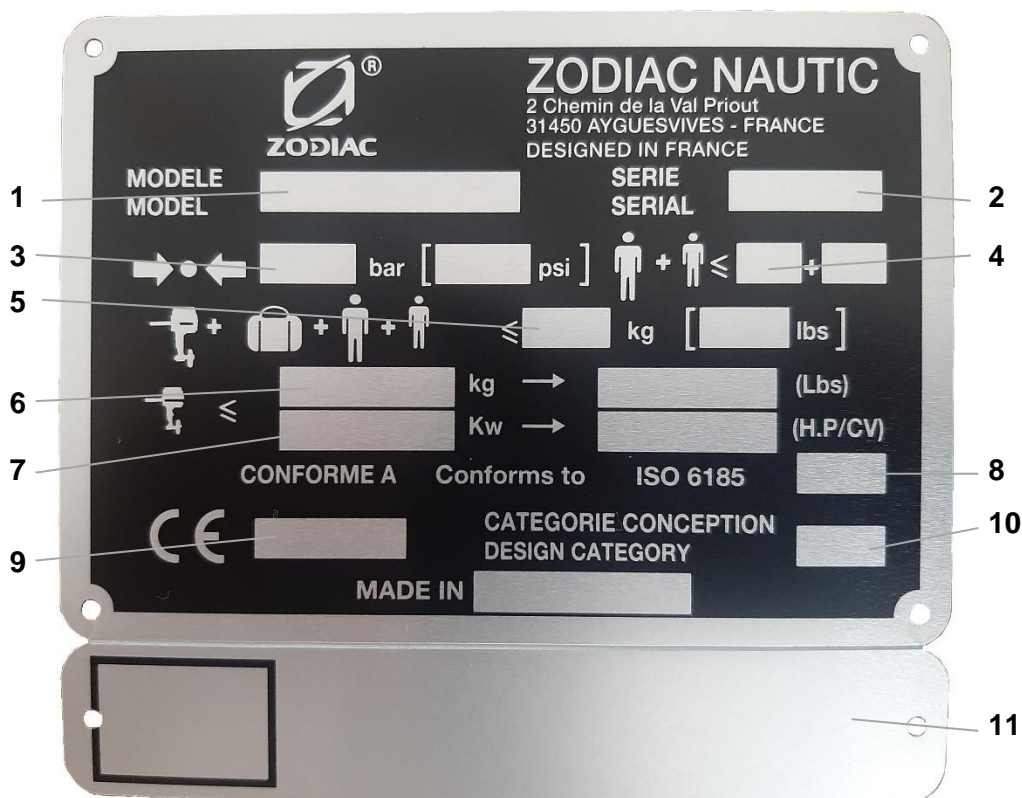

MERKEPLATE

Indikasjonene som er angitt på merkeplaten festet på speilhekken, er viktige.

De informerer hovedsakelig om begrensningene som er knyttet til gjeldende normer i de fleste landene og til den typen bruk båten er beregnet på.

De indikasjonene som er angitt **utgjør ikke en utfyllende liste**: kravene i forhold til navigering (obligatorisk sikkerhetsutstyr i båten, maksimal tillatt avstand fra sikkert fortøyningssted i le, osv.) kan

variere fra land til land eller mellom stater. **Informér deg og respekter alltid nasjonale og lokale lover og forskrifter i landet der du navigerer.**

(1) **Modell:** Seriens handelsnavn.

(2) **Serienummer:** identifiserer båtserien. Må oppgis ved alle serviceinngrep og ved kjøp av reservedeler eller tilbehør.

(3) **Nominelt trykk til oppblåsing** av tubene i Bar eller PSI. Andre deler av båten kan ha andre trykk. Se kapitlet OPPBLÅSING (eierhåndbokens BIND 2) eller indikasjonene på ventilene.

(4) **Maksimalt antall personer** som er tillatt ombord i båten med egnet utstyr (voksne + eventuelt 1 barn) iht. ISO-standardene

(5) **Maksimal total last** som er tillatt av fabrikanten, uttrykt i kilogram og pund (personer + motor og full drivstofftank + diverse last...) definert i iht. gjeldende ISO-norm 14945

(6) **Maksimal motorvekt** som er tillatt for båten, i kilogram og pund.

(7) **Maksimal motoreffekt** som er tillatt for båten, i kilowatt og hestekrefter.

(8) **ISO-kategori:**

Båten din oppfyller kravene i normen ISO 6185. Hvilken kategori den tilhører, bestemmes av motorens nominelle ytelse.

ISO-kategori	II	V	VII
Nominell motorytelse i kW	0 - 4,5 kW	4.5 - 15 kW	>15 kW
Nominell motorytelse i HK	0 - 6 HK	6 - 20 HK	>20 HK

(9) **EU:** Merking i samsvar med det europeiske direktivet 2013/53/EU (fra største lengde på 2,5 m) etterfulgt av nummeret til sertifiseringsorganet (kun for båter i utformingskategori B)

(10) **Utformingskategori (europeisk direktiv 2013/53/EU)** (fra største lengde på 2,5 m):

Avhengig av hvilken utformingskategori båten din tilhører, vil du være godkjent til å kunne navigere i ulike kategorier:

Kategori	B	C	D
Type navigasjon	"i åpent hav"	"nær kysten"	"i smult farvann"
Vindstyrke (Beauforts skala)	Opp til og med 8	Opp til og med 6	Opp til og med 4
Signifikativ bølgehøyde (m)*	Opp til og med 4	Opp til og med 2	Opp til og med 0,5

*Den representerer gjennomsnittshøyden på den øvre tredjedelen av bølgene, noe som tilsvarer tilnærmet antatt bølgehøyde beregnet av en erfaren observatør. Enkelte bølger har dobbelt så stor høyde som denne verdien.

Enkelte av våre båter er godkjent for to navigasjonskategorier. For å kunne indikere alle karakteristikk for hver kategori, er de utstyrt med to ulike merkeplater.

(11) **Liten plate**, vanligvis festet til utsiden av speilhekken, og som angir båtens individuelle identifikasjonsnummer (CIN – Craft Identification Number).

 ADVARSEL	<p>Opptre ansvarlig: opprett et navigasjonsprogram hvor du tar hensyn til alle nevnte parametre. Dra ikke ut på sjøen dersom disse risikerer å bli overskredet.</p>
------------------------------------------------------------------------------------------------------	---------------------------------------------------------------------------------------------------------------------------------------------------------------------

VALG AV MOTOR OG PROPELL

1. VALG AV MOTOR

1.1. Motorens effekt

- De anbefalte og maksimale effektene er angitt i tabellen over båtens tekniske karakteristikk (jvf. eierhåndbokens BIND 2).
- Ved lave effekter bør du foretrekke motorer med roppinnestyring.

Over 25 HK anbefaler vi at du bruker fjernstyring som gir større komfort og sikkerhet.

 ADVARSEL	<p>Bruk av en motor med større effekt enn den maksimalt tillatte effekten (angitt på merkeplaten), kan føre til tap av kontroll og er dermed reglementstridig.</p>
--------------------------------------------------------------------------------------------------------	---------------------------------------------------------------------------------------------------------------------------------------------------------------------------

MERK:	<p>Den tillatte maksimaleffekten, når den er over den anbefalte, må brukes med ekstrem varsomhet. Den gjelder utelukkende for erfarne brukere som benytter båten under svært spesifikke forhold (transport av tung last osv.).</p> <p>Vi anbefaler at du velger motorens effekt ut fra din vanligste måte å bruke båten på og at du sjekker anbefalt effekt (se BIND 2).</p> <p>Bruk av tillatt maksimal effekt risikerer å gjøre styringen vanskelig. Ved utilstrekkelig effekt risikerer du at båten ikke har tilstrekkelig sikkerhetsmargin til å stå imot sterk vind og strøm.</p>
--------------	----------------------------------------------------------------------------------------------------------------------------------------------------------------------------------------------------------------------------------------------------------------------------------------------------------------------------------------------------------------------------------------------------------------------------------------------------------------------------------------------------------------------------------------------------------------------------------------

1.2 Motorens vekt

Motorens vekt har stor innvirkning på båtens planing, stabilitet og ytelser. Ved lik effekt anbefales det å velge den letteste motoren.

Du må aldri installere en motor som er tyngre enn maksimalvekten som er oppført på merkeplaten.

1.3 Motorens akselstørrelse

Det finnes 4 typer motorakslar: **S/L/XL/XXL**. Alle båter er beregnet på en bestemt akseltype. **De kan ikke byttes om.** Sjekk hvilken akseltype som passer for din båt (jvf. BIND 2).

2. VALG AV PROPELL

- For å velge propellen som passer til din bruk av båten, må båten og motoren prøves på vann. Be forhandler om hjelp.
- Propellen som fulgte med motoren, passer generelt til alle typer navigasjon. Men ut fra den viktigste bruken av båten bør du velge:

En kort stigning når båten trenger sterk skyvekraft for planing (båt med tung last, vannski ...).

En lang stigning øker ditt hastighetspotensial (hvis båten er lite lastet).

 <p>FARE</p>	<p>All kontakt med en roterende propell kan medføre alvorlige skader og til og med død.</p> <p>Hold deg alltid på god avstand fra propellen.</p>
------------------------------------------------------------------------------------------------------	----------------------------------------------------------------------------------------------------------------------------------------------------------------

INSTALLASJON OG INNSTILLING AV MOTOREN

3. INSTALLASJON AV MOTOREN

- Installer motoren i båtens akse, midt på monteringsplaten (4).
- Trekk helt til brakettene (1) for hånd, og trekk dem til igjen etter 15 minutters navigasjon ved første installasjon.
- For all festing av motorene med bolter, ta kontakt med din nærmeste agent.
- Fest motoren til løkken (3) med en sikkerhetskabel (2) og til klemmeskruene (1).
- Alle motorer på mer enn 4 HK er utstyrt med nødstop (5), som er et ekstremt viktig sikkerhetselement. Fest den alltid rundt håndleddet ditt (se kapitlet "navigasjonsråd").

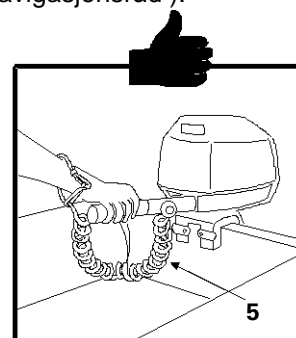
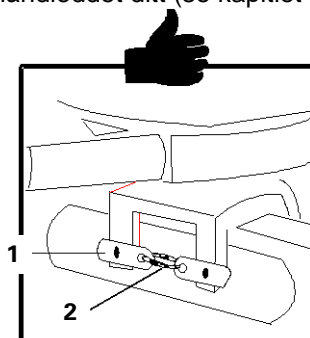
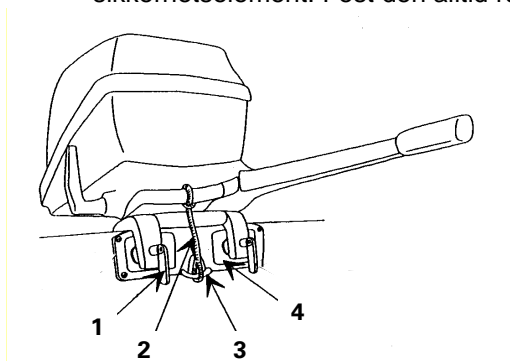

 OBS	<ul style="list-style-type: none"> • FESTING AV MOTOREN MED BOLTER ER ANBEFALT FRA 10 HK, OG ER HELT NØDVENDIG OVER 25 hk. • Fra 25 hk anbefaler vi bruk av fjernstyring.
---------------------------------------------------------------------------------------------------	----------------------------------------------------------------------------------------------------------------------------------------------------------------------------------------------------------

 ADVARSEL	<ul style="list-style-type: none"> • For de motorene som ikke er festet med bolter: sjekke stramningen på brakettene regelmessig. • For fjernstyringer: kontroller regelmessig at de fungerer som de skal.
--------------------------------------------------------------------------------------------------------	------------------------------------------------------------------------------------------------------------------------------------------------------------------------------------------------------------------------------------

MERK:	Bolting må ikke gjøres før motoren er nøyaktig plassert. Be forhandler om hjelp.
--------------	-----------------------------------------------------------------------------------------

4. INNSTILLINGER

Motoren krever dobbelt innstilling av posisjonen i høyden og helning (tilt) i forhold til speilhekk, og dette har stor direkte innvirkning på båtens oppførsel.

Du trenger bare å justere motoren i høyden én gang. Derimot vil du nok bli nødt til å endre motorens helning (tilt) i forhold til navigasjonsforholdene (justeringspinne eller elektrisk trim) for å optimere båtens ytelser og manøvrerbarhet.

4.1. Motorens høyde

Motoren monteres direkte på den bakre speilhekk. Alt etter motormerke, med samme type aksel, kan størrelsen variere med noen centimeter.

Noen er det nødvendig å legge på justeringsshim for å sikre riktig plassering av motoren:

Motoren stilt inn for høyt = motoren løper løpsk (ventilering)
 Motoren stilt inn for lavt = utilsiktet vannsprøyt (spruting)

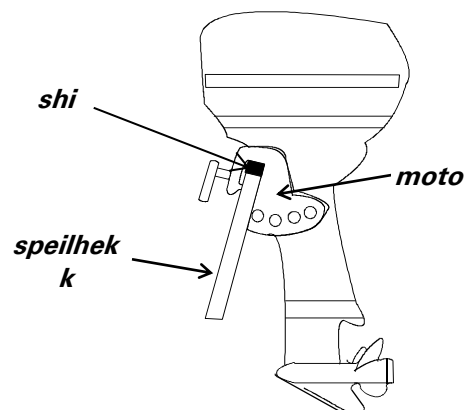

MOTORENS INNSTILLINGER

4.2 Motorens helning

Vanligvis skal motoren helles slik at propellens akse er parallell med vannoverflaten.

Men en annen helningsinnstilling kan anbefales i andre situasjoner (se kapitlet NAVIGASJONS RÅD).

Innstilling av motorens helning kan skje manuelt eller med trim for motorer som har dette.

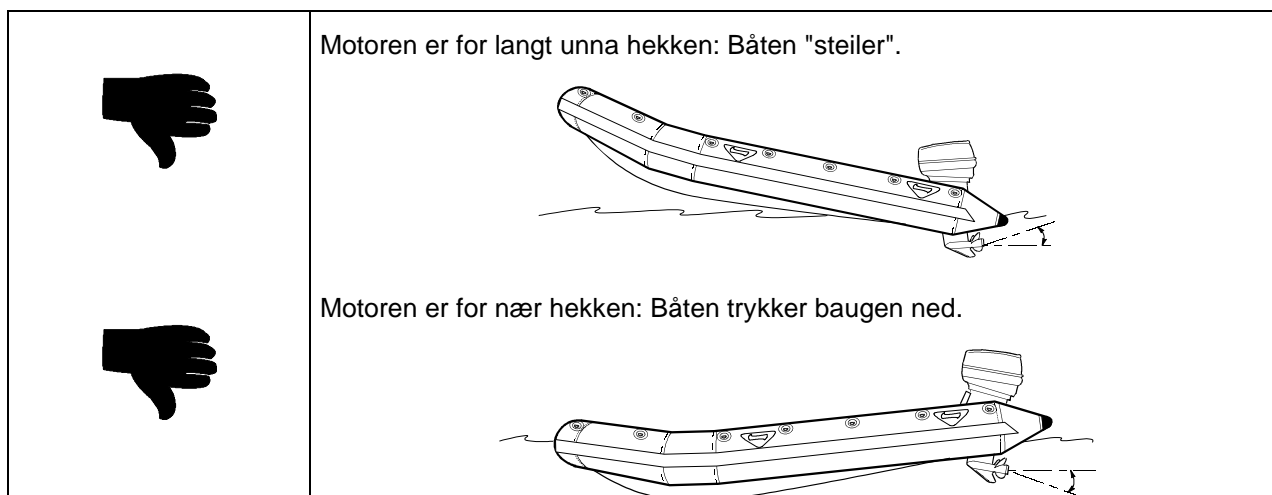
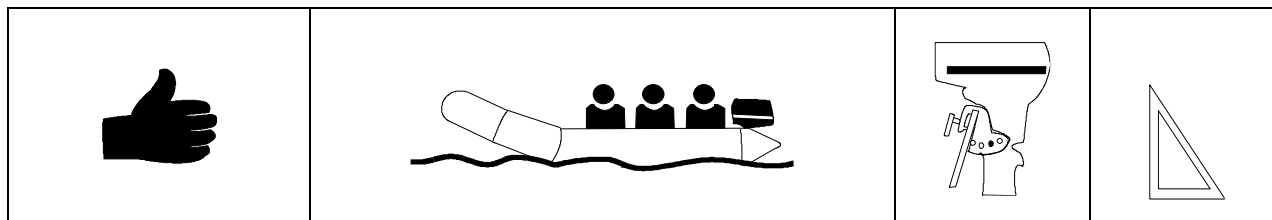

 <p>ADVARSEL</p>	<p>Dersom motorens helning stilles inn manuelt, stans motoren før det utføres endringer.</p>
<p>MERK:</p>	<p>Se produsentens håndbok når det gjelder informasjon om den spesifikke motoren.</p>

NAVIGASJONSRÅD**Fordeling av lasten:**

- Fordel lasten jevnt. (Du kan for eksempel feste drivstofftanken foran for å utligne motorens vekt bak).
- Ved styring med rorpinne skal føreren befinne seg babord i båten.

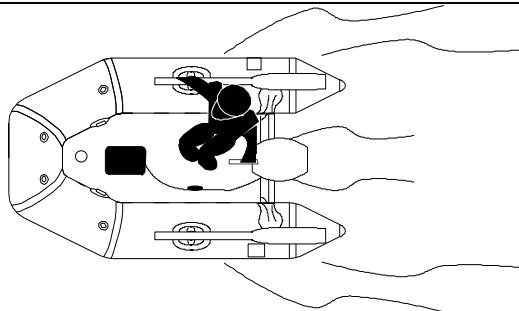
Eksempel på riktig fordeling av lasten:**OBS**

Dårlig fordeling av lasten om bord kan destabilisere båten og ha konsekvenser for hvordan den oppfører seg på sjøen.

**OBS**

Når båten er lite lastet, reagerer den svært følsomt. Vær spesielt årvåken ved akselereringer og endring av retning.

Avhengig av navigasjons- og sjøforholdene, vil det kanskje bli nødvendig å utføre endringer i lastfordelingen og på motorens helning:

Sterk sjø forfra:
 Laste båten i baugen og, hvis nødvendig, justere motorens tiltpinne i 1. eller 2. hull
 Negativ trim

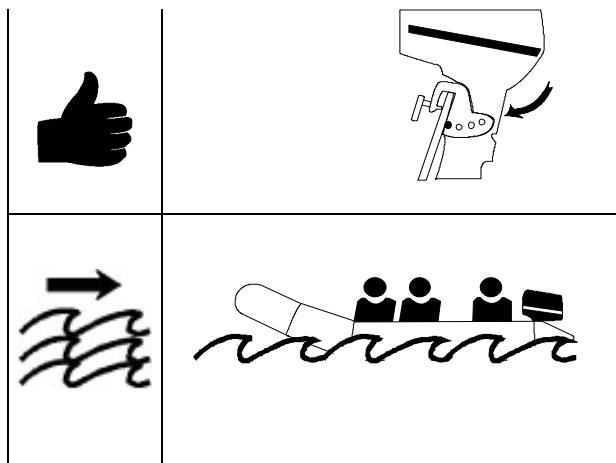

Sterk sjø bakfra:
 Laste båten akter og, hvis nødvendig, justere motorens tiltpinne i 3. eller 4. hull
 Positiv trim

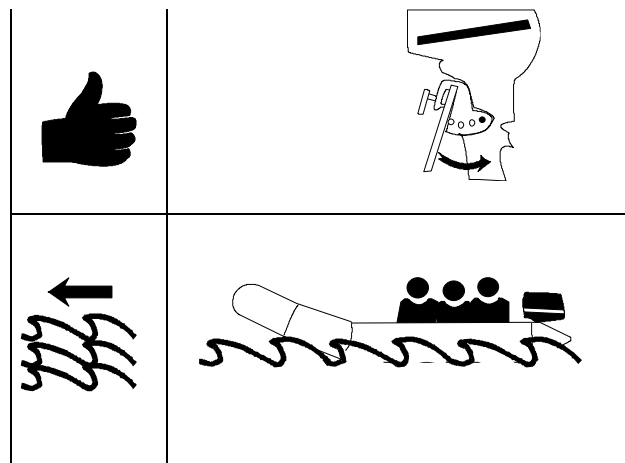

 OBS	<p>Ikke kjør båten med negativ triminnstilling (lav baug) i stor hastighet. Båten kan få salgside og føre til at den blir ustabil i svingene. Bruk negativ trim for å gå fra bevegelseshastighet til vannplaningshastighet, og til lavere hastigheter i bølger (dersom motoren har elektrisk trim)</p>
---------------------------------------------------------------------------------------------------	---------------------------------------------------------------------------------------------------------------------------------------------------------------------------------------------------------------------------------------------------------------------------------------------------------------

NAVIGASJONS RÅD

SIKKERHET FORAN ALT Du må vite hvordan du forhindrer risiko for ulykker

KONTROLLER FØR START

 ADVARSEL	<p style="text-align: center;">Informér deg selv og passasjerene:</p> <ul style="list-style-type: none"> <input checked="" type="checkbox"/> INFORMER DEG OM FORSKRIFTENE OG EVENTUELLE FARER SOM GJELDER SPESIFIKT VED LOKAL NAVIGASJON. <input checked="" type="checkbox"/> SJEKK VÆRMELDINGEN: informér deg om farer grunnet klimatiske forhold, tidevann, vind og strømmer samt forholdene på sjøen. <input checked="" type="checkbox"/> INFORMER en person på land om hvor du skal og når omtrent du skal være tilbake. <input checked="" type="checkbox"/> LÆR DEG HVOR STOR AUTONOMI BÅTEN DIN HAR: den distansen du kan kjøre med full drivstofftank kan variere mye alt etter forholdene på sjøen. Sørg for at du alltid har tilstrekkelig drivstoff til å komme til en nødhavn. <input checked="" type="checkbox"/> FORKLAR basisoperasjonene for samtlige passasjerer. <input checked="" type="checkbox"/> FORSIKRE DEG om at en av passasjerene kan manøvrere i nødstilfelle.
	<p style="text-align: center;">Kontroller at materiellet fungerer som det skal iht. forholdene på sjøen og bruken.</p> <ul style="list-style-type: none"> <input checked="" type="checkbox"/> KONTROLLER trykket i tuben. <input checked="" type="checkbox"/> KONTROLLER skroggjennomføringene: fjern proppene fra lenseventilene og sjekk at lenseproppene på utsiden av båten er stengt. <input checked="" type="checkbox"/> KONTROLLER at nødstoppen fungerer riktig. <input checked="" type="checkbox"/> KONTROLLER at motoren er godt festet til speilhekken. <input checked="" type="checkbox"/> KONTROLLER og rengjør bensinfilteret, hvis det finnes. <input checked="" type="checkbox"/> KONTROLLER drivstoffmengden du har til rådighet. <input checked="" type="checkbox"/> HUSK å etterfylle olje hvis motoren har en egen oljetank. <input checked="" type="checkbox"/> FESTE drivstofftanken på den plassen som er forutsett for denne. Kontroller at alle mobile deler er festet. <input checked="" type="checkbox"/> KONTROLLER at motoren er i nøytral før du starter motoren.

	<p style="text-align: center;">MATERIELL OMBORD: (se lover og forskrifter i ditt land).</p> <p><input checked="" type="checkbox"/> En redningsvest til hver person ombord. Den skal være tilpasset personens morfologi og området det navigeres i.</p> <p><input checked="" type="checkbox"/> Fotpumpen, padleårene (eller vanlige årer), reparasjonssettet, motorens verktøy.</p> <p><input checked="" type="checkbox"/> Det obligatoriske sikkerhetsutstyret.</p> <p><input checked="" type="checkbox"/> Båtpapirene og ditt sertifikat.</p> <p><input checked="" type="checkbox"/> En elektrisk lampe (i tillegg til de påbudte lanternene) for eventuell navigasjon om natten.</p>
--	---------------------------------------------------------------------------------------------------------------------------------------------------------------------------------------------------------------------------------------------------------------------------------------------------------------------------------------------------------------------------------------------------------------------------------------------------------------------------------------------------------------------------------------------------------------------------------------------------------------------------------------------------------------------------------------------------

NAVIGASJONS RÅD**SIKKERHET FORAN ALT VIT HVORDAN DU FOREBYGGER FARER FOR ULYKKE****REGLER SOM MÅ RESPEKTERES VED NAVIGASJON**

- Opptre ansvarlig. Du må aldri utsette deg eller andre for livsfare på grunn av manglende overholdelse av sikkerhetsreglene.
- Overhold forkjøringsreglene slik de defineres i sjøveisreglene fra COLREG (konvensjonen om internasjonale regler til forebygging av sammenstøt på sjøen)
- Forsikre deg om at du alltid har nødvendig avstand for å kunne stanse eller styre unna for å unngå kollisjon hvis nødvendig.
- Ikke kjør med full hastighet i områder med stor trafikk eller ved nedsatt sikt, sterk vind eller store bølger.
- Senk hastigheten og reduser kjølvannet av høflighet og av sikkerhetshensyn både for deg selv og andre. Respekter områdene med begrenset hastighet og kjølvann.
- Du må alltid kunne beherske båten, og vær alltid årvåken når du navigerer.
- Vær alltid respektfull og høflig.
- Følg gjeldende lover og forskrifter i navigasjonslandet.
- Når du navigerer nær land, følg merkede leder og kjør med lav hastighet.
- Værforholdene kan forverres raskt til sjøs. Sørg alltid for at du vil komme raskt i le.

**OBS****VÆR FORSIKTIG MED FRALANDSVIND OG -STRØMMER!**



ADVARSEL

REDNINGSVESTER: vi anbefaler bruk av redningsvest under navigasjon, og uten unntak for barn og personer som ikke kan svømme.

NØDSTOPP: Fest alltid nødstoppen, helst på håndleddet, eller dersom dette ikke er mulig, på en fast del av plagget du har på. Ta alle forholdsregler for å unngå utilsiktet utløsning av nødstoppen da dette vil føre til spesielt vanskelig tap av kontroll under manøvrering.

VERKEN ALKOHOL ELLER NARKOTISKE STOFFER: Du må ikke føre båten hvis du har inntatt alkohol eller narkotiske stoffer. Kontroller at passasjerene ikke er påvirket.

Overstig aldri de tillatte verdiene for effekt og vekt, og heller ikke antall passasjerer.

SØRG FOR AT PASSASJERENE aldri befinner seg i baugen med beina på utsiden av båten: Ved fall i sjøen er vedkommende i propellens bane.

SØRG FOR at passasjerene befinner seg i sikre posisjoner og unngå brå retningsendringer med unntak i absolutt nødvendige tilfeller.

Reduser hastigheten i bølger for å gi passasjerene komfort og sikkerhet.

I alle tilfeller må du varsle passasjerene før manøveren.

UNNGÅ SKARP SVINGING MED HØY HASTIGHET: Du risikerer at passasjerene eller du selv slynges ut av båten.

VÆR SPESIELT OPPMERKSOM NÅR DU LEGGER TIL LAND: Armer og bein kan bli utsatt for skade dersom de befinner seg på utsiden av båten under manøvreringen.

IKKE GLEM AT PROPELLEN ER EN FARE FOR BADENDE OG DYKKERE:

Du må ikke tillate at passasjerene bader mens motoren går, og være særlig varsom når du navigerer nær et område der det bades.

Alfa-flagg betyr at det er dykkere tilstede: det må holdes stor avstand til båten (minst 100 meter).

Gå aldri ut av båten uten å ha fortøyd eller forankret den.

NAVIGASJONS RÅD

SIKKERHET FORAN ALT Du må vite hvordan du forhindrer risiko for ulykker

Regler som skal overholdes ved navigasjon (fortsettelse)

 <p>ADVARSEL</p>	<ul style="list-style-type: none"><input checked="" type="checkbox"/> VÆR FORSIKTIG: Unngå at tuben kommer i kontakt med skjærende gjenstander eller etsende væsker (f.eks. syre). <input checked="" type="checkbox"/> VÆR OBS PÅ BATTERIET: Pass deg for elektriske utladninger og batterisyre. <input checked="" type="checkbox"/> UNNGÅ EKSPLOSJONS- OG BRANNFARE: Velg ditt system for drivstofftilførsel og hold det i god stand. <input checked="" type="checkbox"/> DET ER FORBUDT Å RØYKE under fylling av drivstofftanken. <input checked="" type="checkbox"/> Dersom det blir sølt bensin i bunnen av båten, skyll ut med store mengder vann.
----------------------------------------------------------------------------------------------------------	-------------------------------------------------------------------------------------------------------------------------------------------------------------------------------------------------------------------------------------------------------------------------------------------------------------------------------------------------------------------------------------------------------------------------------------------------------------------------------------------------------------------------------------------------------------------------------------------------------------------------------------------------------------------------------------------------------------------------------------------------------

VED ULYKKE

Unngå panikk ved ulykke, og sørg for å berolige passasjerene. Selv om den er skadet, forblir båten ofte det beste vernet og den gjør at redningsmannskaper finner deg lettere. Ikke prøv å svømme inn til land.

En gummibåt synker praktisk talt aldri, selv om den er full av vann. Hvis luften går ut av et luftkammer etter en ulykke, må du trekke det inn mot innsiden av båten, plassere lasten på motsatt side av det tomme luftkammeret og kjøre til land med redusert hastighet.

I tilfelle kollisjon eller sammenstøt med en flytende gjenstand, stopp for å undersøke bunnen (skroget på RIB-båter), tubene, motoren og motorfestene før du kjører til land igjen med redusert hastighet.

Før neste tur må du be forhandleren om å foreta grundig inspeksjon av båten.



**OBS**

Dersom skadene ikke undersøkes nøye eller ikke blir reparert, kan det føre til redusert resistens og kortere levetid for båten din, noe som også kan være en årsak til uhell.

MILJØET

For ansvarsbevisst navigering

Båten gjør det mulig å oppdage den naturlige rikdommen i havmiljøet, og vi ber deg respektere miljøet ved å følge disse grunnreglene:

	<ul style="list-style-type: none"> <input checked="" type="checkbox"/> Respekter livet til dyrene som lever i og rundt havet. <input checked="" type="checkbox"/> Gjør deg kjent med internasjonale regler mot forurensing til havs (MARPOL), og overhold disse så langt det lar seg gjøre. <input checked="" type="checkbox"/> Hold deg informert om lokale miljøvernregler og følg disse i praksis. <input checked="" type="checkbox"/> Dersom båten din er utstyrt med toaletter, må ikke disse eller innholdet i samletankene tømmes nær land eller i forbudte områder. Bruk pumpesystemet i havnene eller på marinaene til dette. <input checked="" type="checkbox"/> Bruk ikke-forurensende maling (antifouling) og rengjøringsmidler. <input checked="" type="checkbox"/> Hold avstand fra områder som er reservert for bading. <input checked="" type="checkbox"/> Begrens støy: vis hensyn overfor andre og unngå overdreven støy og unødig eksosutslipp. <input checked="" type="checkbox"/> Vær oppmerksom under fylling av drivstofftanken. Overflødig drivstoff som samler seg i oppsamlingskaret må nøye fjernes og kastes i en egnet søppelkasse for å unngå utilsiktet drivstoffsøl i havet.
	<ul style="list-style-type: none"> <input checked="" type="checkbox"/> Ikke slipp hydrokarboner (oljer og drivstoff) ut i naturen. <input checked="" type="checkbox"/> Ikke kast avfall og søppelsekker på sjøen. <input checked="" type="checkbox"/> Ikke fremkall bølger og kjølevann som er til sjenanse for folk på land.

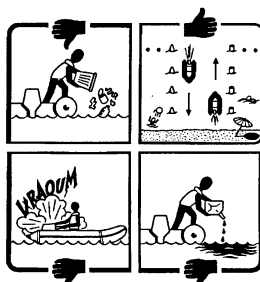

VEDLIKEHOLD

1. ANKRING OG SLEPING

1.1 Ankring

Sammenleggbare båter: bruk ringene på siden av tuben.

RIB-båter: bruk ringen i forstavnen.

MERK:	Ved lengre tids ankring kan lenseventilene være åpne for at vannet føres ut hvis det regner mye.
--------------	--------------------------------------------------------------------------------------------------



1.2 Sleping

For å ta en sammenleggbar båt på slep på sjøen, bruk en "V"-formet fortøyning gjennom de to ringene på begge sider av tuben som er forutsett for dette. For RIB-båter, fortøy direkte i ringen i forstavnen på skroget.

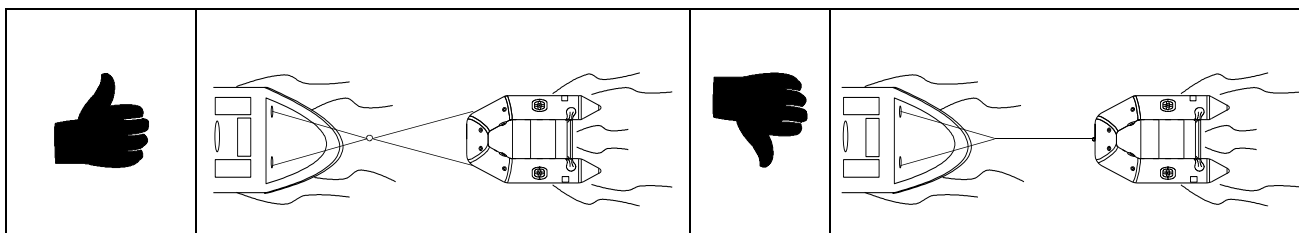

Sleping av sammenleggbare båter:

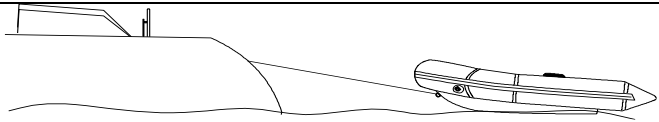

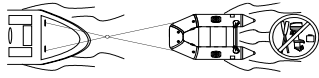
Sleping av RIB-båter:

Bruk førtøyningsringen i forstavnen		
Tøm båten (bager, drivstofftank, motor, årer) før sleping.		

MERK:	Slepingen må foregå ved lav hastighet og under gode meteorologiske forhold (stille sjø og svak vind).
--------------	-------------------------------------------------------------------------------------------------------

 <p>OBS</p>	<p>Forankringspunkter som viser synlige tegn på forringelse må skiftes ut. De må være gjenstand for regelmessig kontroll.</p>
 <p>OBS</p>	<p>En slepekabel må alltid være fortøyd på en slik måte at den kan kastes loss under belastning.</p>
<p>MERK:</p>	<p>Forsikre deg om at fortøyningstrosser, slepekabler, kjettinger og forankringsliner samt ankrene er egnet for den bruken båten er bestemt for. Spesielt må ikke linene eller kjettingene overskride 80% av bruddstyrken til det tilsvarende forankringspunktet (jfr. Bind 2). Be forhandleren din om hjelp hvis nødvendig.</p>

1.3 Forankring på brygge

Båten kan forankres på en brygge ved hjelp av minst to trosser: én i baugen og én i akterenden.

Trossen kan festes på et fast, tilstrekkelig solid sted på båten:

- RIB-båter: klampe, fortøyningsring i forstavn, fortøyningspullert, røstjern på speilhekken (ikke bruk stedene som ikke er beregnet på dette: reling, håndtak, dekk, håndlist, liten ring på tube...)
- Gummibåter og joller: Klamp, røstjern i stavn, slepering, håndtak forut (ikke bruk de stedene som ikke er beregnet på dette: Reling, bærehåndtak, liten ring på tuben, ...).



Båten må absolutt beskyttes med fendere mot gnidning mot brygga.

Trossene må ikke gni mot tubene. Dersom bryggas konfigurasjon er slik at dette ikke kan unngås, må tuben beskyttes på de aktuelle gnidningsstedene (f. eks. et tykt stoff eller trosse tredd inn i en hageslange).

Enhver båt som forankres på brygge må overvåkes regelmessig, og trossen må eventuelt forsterkes ut fra værforholdene.

2. LØFTING - DAVITER

For løfting og plassering på davit, bruk løfteringene som er forutsett for dette (se Bind 2) eller du må få forhandleren din til å montere de for deg.

 ADVARSEL	<p>Ingen passasjerer ombord under løftingen.</p>
 OBS	<p>Båten må være tømt for alt utstyr når den løftes eller plasseres på davit. Lenseventilene må være åpne og båten må ha helning akter for å sikre eventuell tømming av vann.</p>

VEDLIKEHOLD

3. SETTE BÅTEN PÅ TILHENGER

- Båten skal være godt pumpet opp.
- Lenseventilene skal være åpne.

3.1 Gummibåter:

- Juster rullene (1) på tilhengeren slik at de støtter tubene på begge sider og bak.
 - Trekk båten opp på tilhengeren med sideringene.
 - Bunnen av speilhekken skal hvile på tilhengeren.
-
- Plasser motoren i navigasjonsposisjon slik at den får riktig støtte på tilhengeren (2).
 - Sørg for at båten er godt festet og ligger flatt.
 - Fjern/surr til alt utstyr som kan løsne og slynges ut.
 - Sørg for plassering med klosser om nødvendig, og trekk godt til stroppene. Legg inn beskyttelser på tubene for å unngå gnidning (4).

3.2 RIB-båter:

- Juster rullene i den midtre delen slik at hele båtens vekt hviler på disse rullene.
- Juster rullene eller sidestøttene slik at de stabiliserer båten (obs! utenom bordganger eller redaner)
- Juster avstanden til håndkoblingen slik at akterspeilet hviler på det siste, midtre hjulet.
- Plasser motoren i navigasjonsposisjon slik at den får riktig støtte på tilhengeren (3).
- Bruk sleperingene og ringen i forstavnen (for de som er utstyrt med dette) for å feste skroget godt på tilhengeren.

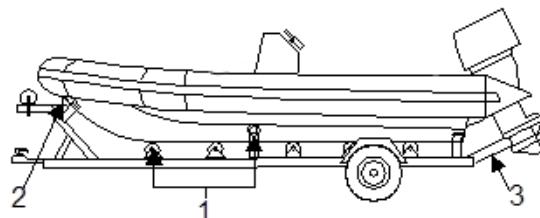

- Fjern eller surr til alt utstyr som kan løsne og slynges ut, også ekstrautstyr og avtakbare deler
- Av sikkerhetsgrunner må propellen dekkes til med en effektiv beskyttelse under kjøring på vei.

 OBS	<ul style="list-style-type: none"> • DERSOM BÅTEN PLASSERES GALT PÅ TILHENDEREN KAN DET RISIKERE Å FØRE TIL UREPARERBARE DEFORMASJONER SOM IGJEN KAN FØRE TIL FUNKSJONSFEIL. • MAKSIMUM TILLATT VEKT FOR TILHENDEREN MÅ ALDRI OVERSKRIDES.
---------------------------------------------------------------------------------------------------	--------------------------------------------------------------------------------------------------------------------------------------------------------------------------------------------------------------------------------------------------------------------

 ADVARSEL	<p>PÅ VEIEN:</p> <ul style="list-style-type: none"> • BÅTEN MÅ ALLTID VÆRE TOM FOR ALT MATERIELL SOM IKKE ER SKIKKELIG FESTET NÅR DEN FRAKTES PÅ TILHENDER. • INGEN PASSASJERER OMBORD UNDER TRANSPORT PÅ TILHENDER.
--------------------------------------------------------------------------------------------------------	-----------------------------------------------------------------------------------------------------------------------------------------------------------------------------------------------------------------------------------------------------

VEDLIKEHOLD

Båtens tube er laget i stoffer som ikke kan råtne. Båten krever enkelt, men uunnværlig vedlikehold fra en samvittighetsfull eier som er opptatt av utstyret skal vare lenge.

1. RENGJØRING

Rengjør båten ofte, spesielt før og etter vinteropplagring.

Det er absolutt nødvendig å rengjøre båten regelmessig, særlig tuben. Du kan også la forhandleren utføre dette da denne har både de nødvendige produktene og den riktige erfaringen til å foreta grundig rengjøring av båten - noe som vil forlenge dens levetid.



**IKKE BRUK HØYTRYKKS-
SPYLER PÅ STOFFENE**

1.1 Rengjøring av tuben

Oppblåst tube:

- Åpne lenseventilen, og skyll båten med vannslange for å fjerne sand og smuss.
- Rengjør tuben regelmessig med **ferskvann og såpe**, minst en gang i måneden i bruksperioden.
- Fjern tjære-/asfaltflekker (for vanskelig flekker, bruk det produktet som er tilgjengelig hos forhandleren).
- Inspiser tuben og se etter eventuelle lekkasjer. Bruk såpevann.
- Skyll med ferskvann, og la båten tørke.



Ikke bruk aggressive rengjøringsmidler (syre, triklor, bensin, aceton) eller silikonbaserte produkter. Dersom det skulle komme sprut på tuben, skyll av med rikelig med vann.

Når luften tas ut:

- Sjekk at ventilene og deres pakninger (tetthet, sand osv.) er i god stand og rene.

- Kontroller at lenseventilen ikke er tilstoppet.

1.2 Sjekk tettheten til tuben:

Merk:	<p>Bruk trykkindikatoren (leveres med enkelte modeller eller kan skaffes fra forhandler), og mål trykkfallet etter 24 timer.</p> <p>TRYKKFALL:</p> <ul style="list-style-type: none"> • Det er normalt å konstatere opptil 20 % trykkfall på 24 timer. <p>(Normer ISO 6185). Dersom du merker større trykkfall enn:</p> <p style="text-align: center;">0,145 PSI (0,010 Bar) / 5 timer for tuben</p> <p style="text-align: center;">0,5 PSI (0,035 Bar) / 5 timer for oppblåsbar dørk Høytrykk</p> <p>Sjekk tettheten.</p> <ul style="list-style-type: none"> • Temperaturen har sterk innvirkning på trykket. En variasjon på 1°C medfører en variasjon i samme retning på nær 0,06 PSI (0,004 Bar = 4 millibar) <p>Ethvert unormalt trykkfall må føre til grundig kontroll av ventilene og deres pakninger. Be forhandler om råd.</p>
--------------	---------------------------------------------------------------------------------------------------------------------------------------------------------------------------------------------------------------------------------------------------------------------------------------------------------------------------------------------------------------------------------------------------------------------------------------------------------------------------------------------------------------------------------------------------------------------------------------------------------------------------------------------------------------------------------------------------------------------------------------------------------------------------------------------------------------------------------------------------------------------------------------------------

1.3 Tilleggsoperasjon for RIB-båter: rengjøring av skroget.

- Fjern tuben (for båter med avtakbar tube).
- Vask dekket og kjølen med såpevann, skyll med ferskvann, og la båten tørke.
- Kontroller at lenseventilen ikke er tilstoppet.
- Åpne lenseproppen for å tømme eventuelt vann som har samlet seg i skroget.
- Tilbakemonter tuben om nødvendig.

VEDLIKEHOLD

1.4 Vedlikehold av deler i rustfritt stål

Vi velger rustfritt stål av toppkvalitet som har forsterket motstandsdyktighet mot rust. Men i havmiljø er det naturligvis utsatt for sterke angrep av salt og vann i kombinasjon.

MERK:	<p>Rustfritt stål er ikke uslitelig og krever et minimum av forholdsregler og vedlikehold:</p> <ul style="list-style-type: none"> • Unngå å kontaminere det i kontakt med jernholdig verktøy: Bruk forkrommet verktøy. • Unngå å lage riper i overflaten. • Skyll hyppig med ferskvann. • Hvis nødvendig kan du gjenopprette den beskyttende filmen med en passiviseringspasta (ta kontakt med forhandleren din).
--------------	--------------------------------------------------------------------------------------------------------------------------------------------------------------------------------------------------------------------------------------------------------------------------------------------------------------------------------------------------------------------------------------------------------------------------------------------------------------------

1.5 Vedlikehold av seter og annet utstyr

Rengjør setene og kryssfinéren med ferskvann og såpe, og tørk deretter av.

Lakk og maling er ikke bare dekorative elementer, de har også en beskyttende rolle. Når overflaten blir flaket eller falmet må du få malt den på nytt med produkter basert på polyuretan.

2. VINTEROPPLAGRING - LAGRING

Utenfor bruksperiodene må du lagre båten på et rent og tørt sted, som er beskyttet mot store temperatursvingninger og uvær.

Du kan lagre båten på to måter:

- Enten brettet sammen i sekken sin.
- Eller montert og ikke fullt oppblåst.

	<ul style="list-style-type: none"> • VED LANGTIDSOPPLAGRING I SOLEN (SPESIELT I TROPISKE OMRÅDER), MÅ BÅTEN BESKYTTES MED EN PRESENING FRA VÅRT UTVALG. • BESKYTT BÅTEN MOT SMÅ GNAGERE (rotter, mus) som kan lage hull i tuben. • DERSOM DU LAGRER BÅTEN DIN OPPBLÅST, SØRG FOR AT DEN IKKE FÅR NOEN DEFORMASJONER.
-------------------------------------------------------------------------------------	----------------------------------------------------------------------------------------------------------------------------------------------------------------------------------------------------------------------------------------------------------------------------------------------------------------------------------------------------------------------------

3. DIVERSE KONTROLLER

- Kontroller regelmessig standen til roret, signallinene og stroppene. Få skiftet ut delene som har spor etter slitasje.
- Kontroller regelmessig at skruene og mutrene er trukket til, særlig motorens bolting.
- Undersøk regelmessig standen til systemet for drivstofftilførsel. Få skiftet ut delene som har spor etter slitasje eller aldring. Sjekk at kragene er trukket til.

VEDLIKEHOLD

4. REPARASJON AV SMÅ PUNKTERINGER

MERK:	<p>Båten leveres med et reparasjonssett som må være ombord.</p> <p>Reparasjoner under navigasjon er vanskelig. Respekter mest mulig instruksjonene nedenfor. Reparer på nytt eller la forhandleren din utføre den så snart du kommer til land igjen.</p>
--------------	----------------------------------------------------------------------------------------------------------------------------------------------------------------------------------------------------------------------------------------------------------

REPARASJONSSETT	<p>Slik går du frem for å rengjøre:</p> <ul style="list-style-type: none"> ➤ Mildt løsemiddel til rengjøringen (etylacetat) (leveres ikke med) <p>Slik reparerer du:</p> <ul style="list-style-type: none"> ➤ Stoffdeler. ➤ Limtube eller reparasjonspatch til disposisjon (Patch'n Go) ➤ Pensel - skrape (leveres ikke med) ➤ Instruksjonsark
BETINGELSER FOR OPTIMAL REPARASJONSKVALITET	<ul style="list-style-type: none"> ➤ Temperert fuktighetsgrad: hygrometri <60%. ➤ Temperatur på mellom 18 og 25°C. ➤ Utfør reparasjoner i skyggen og på et tørt sted. ➤ Tuben må være flat, luften tatt ut.
FORBEREDELSE	<ul style="list-style-type: none"> ➤ Finn lekkasjene (med såpevann dersom ikke lekkasjen kan ses tydelig) ➤ Klipp en rund lapp som overlapper hullet i tuben med minst 5 cm eller bruk en egnet patch fra reparasjonssettet. ➤ Strek opp på tuben der hvor lappen skal plasseres. ➤ Rengjør lappen og området rundt hullet med et løsemiddel ➤ La det tørke i 5 minutter.
LIMING	<ul style="list-style-type: none"> ➤ Smør lim på tuben og på lappen. Smør 3 tynne lag med lim på hver, og la det tørke i 3 til 5 minutter mellom hvert lag (limet skal ikke lenger feste seg til fingeren, men må heller ikke være for tørt).

<p>MONTERING AV LAPPEN</p>	<ul style="list-style-type: none"> ➤ Etter at det siste laget har tørket, sett lappen på tuben uten å trykke slik at den kan justeres i tilfelle feil sentrering. ➤ Trykk fra midten og utover for å fjerne eventuelle luftbobler. ➤ Stryk hardt over lappen med en avrundet gjenstand, og begynn på midten av lappen. ➤ Rengjør eventuelle limrester med løsemidlet.
<p>FØR DU BRUKER BÅTEN PÅ NYTT</p>	<ul style="list-style-type: none"> ➤ Unngå å utsette reparasjonen for sol og regn hvis mulig. ➤ La det tørke i 24 timer før du blåser opp tuben igjen.
<div style="text-align: center;">  <p>OBS</p> </div>	<p>Ikke la limtuben ligge i solen eller i nærheten av en flamme eller varmekilde.</p> <p>Du må alltid arbeide i et godt luftet lokale. Unngå å innånde limdamp og å svelge lim, og unngå kontakt med huden.</p>

5. RIB-er: REPARASJON AV RIPER I SKROGET

- Små riper kan reduseres eller fjernes med en pussepasta og pussevatt.
- Dypere riper kan repareres med polyestermastikk eller gelcoat for reparasjon. Be forhandler om råd.

<p>MERK:</p>	<p>Ved større reparasjon av tuben eller skroget, ta kontakt med forhandleren som har de nødvendige produktene, verktøyene og erfaringene for å utføre reparasjoner av høy kvalitet.</p>
---------------------	-----------------------------------------------------------------------------------------------------------------------------------------------------------------------------------------

FEIL: ÅRSAKER OG LØSNINGER

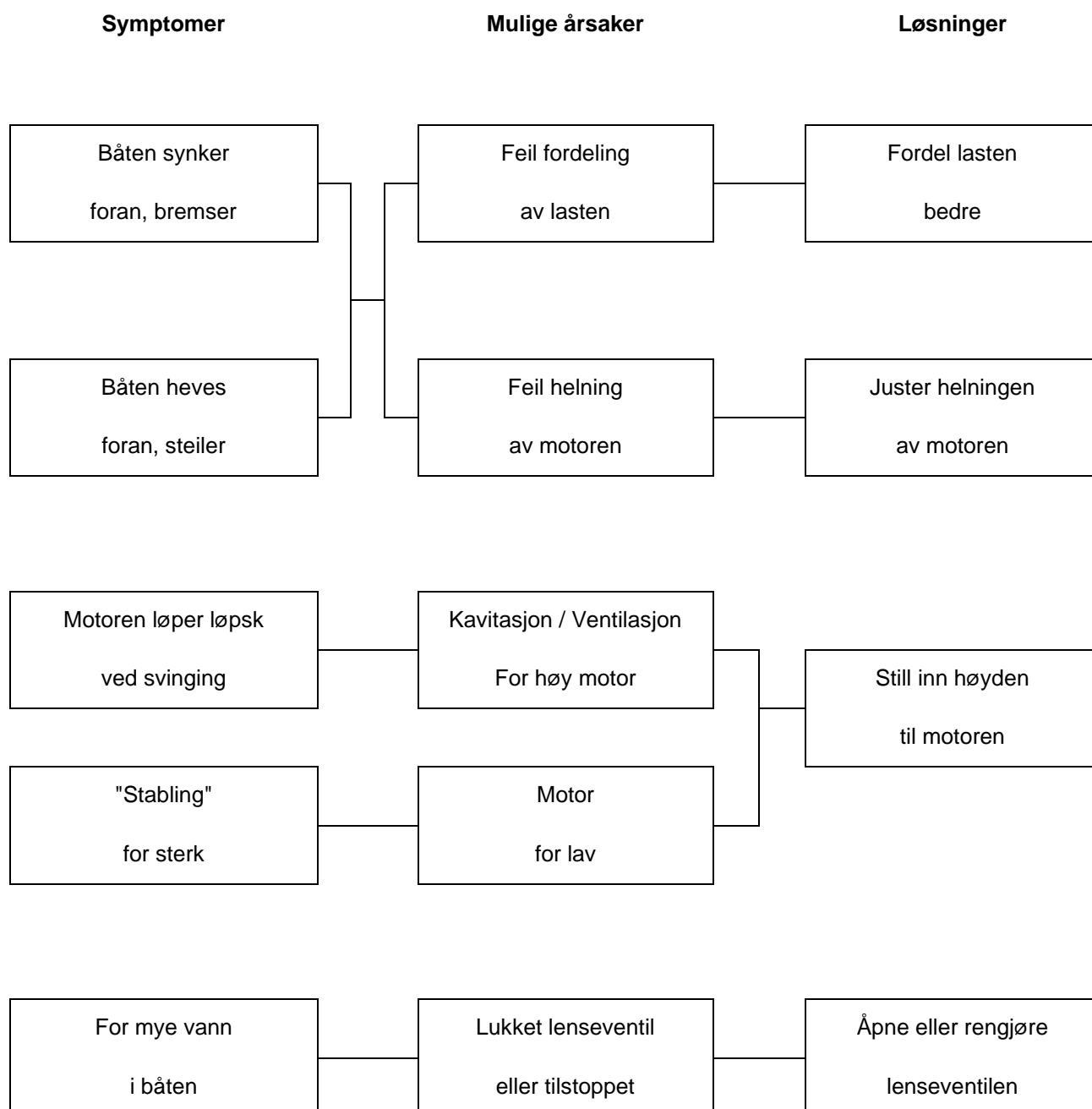

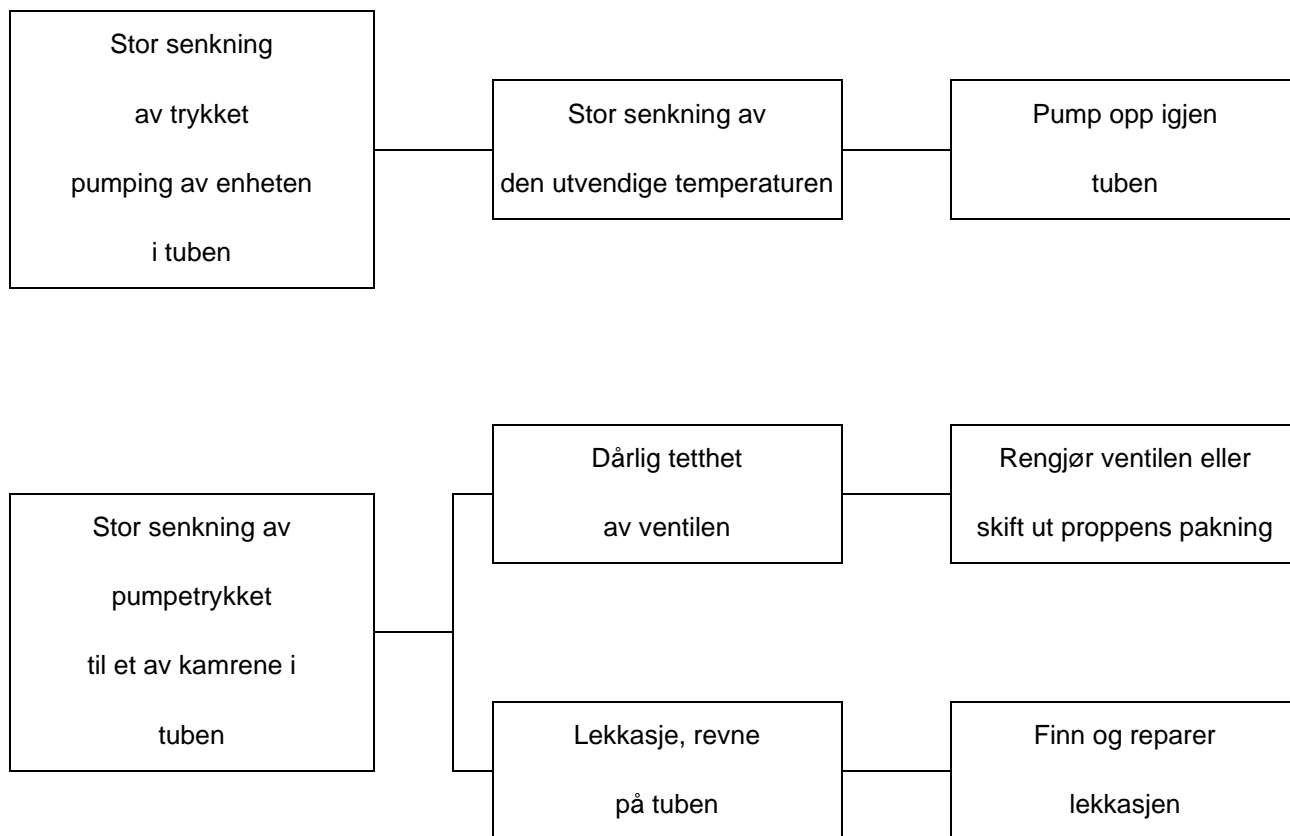

GENERELLE GARANTIBETINGELSER

MERK:	<p>Forsikre deg om at forhandleren har registrert båten din slik at fabrikantgarantien kan opprettes. Forhandleren vil informere deg om betingelsene for iverksettelsen av denne.</p> <p>All påberopelse av denne garantien må også skje via forhandleren din.</p>
--------------	--------------------------------------------------------------------------------------------------------------------------------------------------------------------------------------------------------------------------------------------------------------------

Følgende hovedbegrensninger gjelder ved anvendelsen av denne garantien:

- Båten må ikke ombygges, endres, overmotoriseres eller brukes utenfor tiltenkt bruksområde (race, profesjonell bruk).
- Den maksimale lastvekten må ikke overskrides.
- Oppblåsingstrykket, prosedyrene for montering/demontering og håndtering må respekteres.
- Vedlikeholdet og lagringsbetingelsene må ikke overses.
- Denne garantien gjelder ikke elementer levert av andre enn av produsenten eller feil som skyldes montering av disse elementene.

 ADVARSEL	<p>Båten er blitt fremstilt i samsvar med standardene og for en spesifikk bruk. Endringer, ombygginger eller overmotorisering som er utført for å endre båtens ytelser utgjør en alvorlig risiko for brukeren og fører til opphevelse av garantien.</p>
--------------------------------------------------------------------------------------------------------	---------------------------------------------------------------------------------------------------------------------------------------------------------------------------------------------------------------------------------------------------------

MERK:	<p>Reparasjoner innenfor rammen av garantien vil kun bli utført av vårt godkjente garantinettverk</p>
--------------	-------------------------------------------------------------------------------------------------------

Z NAUTIC
2 Chemin La Val Priout
31450 Ayguesvives
FRANKRIKE