



Operator's Manual PB-580 H/T Power Blower

WARNING

The engine exhaust from this product contains chemicals known to the State of California to cause cancer, birth defects, or other reproductive harm.

WARNING



Read and understand all provided literature before use. Failure to do so could result in serious injury.

This product complies with CAN ICES-2/NMB-2.

TABLE OF CONTENTS

| | |
|--|----|
| Table of Contents..... | 2 |
| Introduction | 3 |
| Servicing Information | 3 |
| Parts/Serial Number..... | 3 |
| Service | 4 |
| ECHO Consumer Product Support..... | 4 |
| Product Registration | 4 |
| Additional Literature | 4 |
| Safety..... | 4 |
| Manual Safety Symbols and Important Information..... | 4 |
| | 5 |
| International Symbols | 5 |
| Personal Condition and Safety Equipment | 7 |
| Equipment..... | 12 |
| Emission Control (Exhaust & Evaporative) | 13 |
| CARB And EPA Emissions Control Information | 13 |
| Description | 14 |
| Contents..... | 18 |
| Assembly..... | 19 |
| Install Blower Pipes and Stick Handle | 19 |
| Install Blower Pipes | 20 |
| Operation | 23 |
| Fuel..... | 24 |
| Fuel | 27 |
| Starting Warm Engine..... | 31 |
| Stopping Engine | 31 |
| Operating Blower | 32 |
| Cold Weather Operation | 34 |
| Adjust the Harness | 35 |
| Maintenance | 36 |
| Skill Levels..... | 36 |
| Maintenance Intervals..... | 37 |
| Cooling System..... | 40 |
| Carburetor Adjustment..... | 44 |
| Throttle Cable Adjustment | 45 |
| Troubleshooting | 47 |
| Storage | 49 |
| Long Term Storage (Over 30 Days)..... | 49 |
| Specifications..... | 50 |
| Product Registration | 51 |

INTRODUCTION

Specifications, descriptions and illustrative material in this literature are as accurate as known at the time of publication, but are subject to change without notice. Illustrations may include optional equipment and accessories, and may not include all standard equipment.



Read and understand all provided literature. Literature contains specifications and information for safety, operation, maintenance, storage and assembly specific to this product. Scan QR codes for more information.



For additional literature, including safety manuals where applicable, or questions regarding terms used in this manual, visit:

<https://www.echo-usa.com/manuals>

OR



<https://www.shindaiwa-usa.com/manuals>

SERVICING INFORMATION

Parts/Serial Number

Genuine ECHO Parts and Assemblies for your ECHO products are available only from an Authorized ECHO Dealer. When you do need to buy parts always have the Model Number and Serial Number of the unit with you. For future reference write them in the space provided below.



Model No. _____
Serial No. _____

Service

Service of this product during the warranty period must be performed by an Authorized ECHO Service Dealer. For the name and address of the Authorized ECHO Service Dealer nearest you, ask your retailer or call: 1-800-432-ECHO (3246). Dealer information is also available on our Web Site www.echo-usa.com. When presenting your unit for Warranty service/repairs, proof of purchase is required.

ECHO Consumer Product Support

If you require assistance or have questions concerning the application, operation, or maintenance of this product, call the ECHO Consumer Product Support Department at 1-800-432-ECHO (3246) from 8:00 am to 5:00 pm (Central Standard Time) Monday through Friday. Before calling, please know the model and serial number of your unit.

Product Registration

Register your ECHO equipment on-line at www.echo-usa.com or by filling out the product registration sheet included in this manual. Registering your product confirms warranty coverage and provides a direct link to ECHO if we find it necessary to contact you.

Additional Literature

In addition to finding information online, information is available from your Authorized ECHO Service Dealer, or by contacting ECHO Inc., 400 Oakwood Road, Lake Zurich, IL 60047 (1-800-432-ECHO (3246)).

SAFETY

Manual Safety Symbols and Important Information

Throughout this manual and on the product itself, you will find safety alerts and helpful, informational messages preceded by symbols or key words. The following is an explanation of those symbols and key words and what they mean to you.

DANGER

The safety alert symbol accompanied by the word “DANGER” calls attention to an act or condition which WILL lead to serious personal injury or death if not avoided.

! WARNING

The safety alert symbol accompanied by the word “WARNING” calls attention to an act or condition which CAN lead to serious personal injury or death if not avoided.

! CAUTION

The safety alert symbol accompanied by the word “CAUTION” calls attention to an act or condition which may lead to minor or moderate personal injury if not avoided.

NOTICE

The enclosed message provides information necessary for the protection of the unit.

Note: This enclosed message provides tips for use, care and maintenance of the unit.













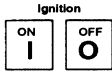

CIRCLE AND SLASH SYMBOL

This symbol means the specific action shown is prohibited. Ignoring these prohibitions can result in serious or fatal injury.

International Symbols

| Symbol | Description | Symbol | Description |
|--------|---|----------|--|
| | Read and Understand the Operator’s Manual | H | Carburetor Adjustment - High Speed Mixture |
| | Wear Eye, Ear and Head Protection | T | Carburetor Adjustment - Idle Speed |
| | Wear Hand Protection | L | Carburetor Adjustment - Low Speed Mixture |
| | Safety/Alert | | Emergency Stop |

| Symbol | Description | Symbol | Description |
|---|---|---|---|
|  | Hot Surface |  | Fuel and Oil Mixture |
|  | Idle speed |  | Fast speed |
|  | Finger severing |  | Primer Bulb |
|  | DO NOT Allow Flames or Sparks Near Fuel |  | Ignition ON / OFF |
|  | DO NOT Smoke Near Fuel |  | Choke Control "COLD START" Position (Choke Closed) |
|  | Choke Control "RUN" Position (Choke Open) |  | Wear Slip Resistant Footwear |
|  | | Beware of thrown objects | |
|  | | Keep Bystanders and Helpers Away 15 m (50 ft.). | |



LOOK BEFORE YOU PUMP!
Ethanol Percentage
0% - 10% 15% - 30% - 50% - 85%
USE E10 OR LESS FUEL
Do not use any fuel containing greater than 10 percent ethanol (E10) in this equipment. It may cause damage or failure and is prohibited by Federal Law.
For Details, see the "Fuel" Section of your Operators Manual

Personal Condition and Safety Equipment

WARNING

Cancer and Reproductive Harm
www.P65Warnings.ca.gov

WARNING



The muffler or catalytic muffler and surrounding cover may become extremely hot. Always keep clear of exhaust and muffler area, otherwise serious personal injury may occur.

WARNING

Users of this product risk injury to themselves and others if the unit is used improperly and/or safety precautions are not followed. Proper clothing and safety gear must be worn when operating unit.

Physical Condition

Your judgment and physical dexterity may not be good:

- If you are tired or sick
- If you are taking medication
- If you have taken alcohol or drugs

Operate unit only if you are physically and mentally well.

Eye Protection

WARNING

- ◆ **Eye protection that meets ANSI Z87.1 or CE requirements must be worn whenever you operate the unit.**
- ◆ **For additional safety, a full-face shield may be worn over safety glasses or goggles to provide protection from sharp branches or flying debris.**

Hand Protection

Wear sturdy, no-slip, rubber work gloves to improve your grip on the handles. Gloves also provide protection against cuts and scratches, cold environments, and reduce the transmission of machine vibration to your hands.

Hearing/Ear Protection

ECHO recommends wearing personal protection whenever unit is used.

Breathing Protection

Operators who are sensitive to dust or other common airborne allergens may need to wear a dust mask to prevent inhaling these materials while operating unit. Dust masks can provide protection against dust, plant debris, and other plant matter such as pollen. Make sure the mask does not impair your vision, and replace the mask as needed to prevent air restrictions.

Proper Clothing

Wear snug-fitting, durable clothing:

- Pants should have long legs, shirts should have long sleeves.
- **DO NOT WEAR SHORTS.**
- **DO NOT WEAR TIES, SCARVES, JEWELRY,** or clothing with loose or hanging items that could become entangled in moving parts or surrounding growth.
- Keep clothing buttoned or zipped, and keep shirt tails tucked in.
- Wear sturdy work shoes with nonskid rubber soles:
- **DO NOT WEAR OPEN TOED SHOES.**
- **DO NOT OPERATE UNIT BAREFOOTED.**

Keep long hair away from engine and air intake. Retain hair with cap or net.

Heavy protective clothing can increase operator fatigue, which may lead to heat stroke. Schedule heavy work for early morning or late afternoon hours when temperatures are cooler.

WARNING

The components of this machine generate an electromagnetic field during operation, which may interfere with some pacemakers. To reduce the risk of serious or fatal injury, persons with pacemakers should consult with their physician and the pacemaker manufacturer before operating this machine. In the absence of such information, ECHO does not recommend the use of this machine by anyone who has a pacemaker.

Extended Operation / Extreme Conditions

CAUTION

Prolonged exposure to cold and/or vibration may result in injury. Read and follow all safety and operation instructions to minimize risk of injury. Failure to follow instructions may result in painful wrist/hand/arm injuries.

It is believed that a condition called Raynaud's Phenomenon, which affects the fingers of certain individuals, may be brought about by exposure to vibration and cold. Exposure to vibration and cold may cause tingling and burning sensations, followed by loss of color and numbness in the fingers. The following precautions are strongly recommended, because the minimum exposure, which might trigger the ailment, is unknown.

- Keep your body warm, especially the head, neck, feet, ankles, hands, and wrists.
- Maintain good blood circulation by performing vigorous arm exercises during frequent work breaks, and also by not smoking.
- Limit the hours of operation. Try to fill each day with jobs where operating the unit or other hand-held power equipment is not required.
- If you experience discomfort, redness, and swelling of the fingers followed by whitening and loss of feeling, consult your physician before further exposing yourself to cold and vibration.

Repetitive Stress Injuries (RSI)

It is believed that overusing the muscles and tendons of the fingers, hands, arms, and shoulders may cause soreness, swelling, numbness, weakness, and extreme pain in those areas. Certain repetitive hand activities may put you at a high risk for developing a Repetitive Stress Injury (RSI). An extreme RSI condition is Carpal Tunnel Syndrome (CTS), which could occur when your wrist swells and squeezes a vital nerve that runs through the area. Some believe that prolonged exposure to vibration may contribute to CTS. CTS can cause severe pain for months or even years.

To reduce the risk of RSI/CTS, do the following:

- Avoid using your wrist in a bent, extended, or twisted position. Instead try to maintain a straight wrist position. Also, when grasping, use your whole hand, not just the thumb and index finger.
 - Take periodic breaks to minimize repetition and rest your hands.
 - Reduce the speed and force with which you do the repetitive movement.
- 
- Do exercises to strengthen the hand and arm muscles.
 - Immediately stop using all power equipment and consult a doctor if you feel tingling, numbness, or pain in the fingers, hands, wrists, or arms. The sooner RSI/CTS is diagnosed, the more likely permanent nerve and muscle damage can be prevented.

DANGER

All over head electrical conductors and communications wires can have electricity flow with high voltages. This unit is not insulated against electrical current. Never touch wires directly or indirectly, otherwise serious injury or death may result.

 **DANGER**

Do not operate this product indoors or in inadequately ventilated areas. Engine exhaust contains poisonous emissions and can cause serious injury or death.

Read the Manual

- Provide all users of this equipment with literature for instructions on safe operation.

Clear the Work Area

- Clear the area of children, bystanders, and pets. At a minimum, keep all children, bystanders, and pets outside a 15 m (50 ft.) radius; outside the 15 m (50 ft.) zone, there is still a risk of injury from thrown objects. Bystanders should be encouraged to wear eye protection. If you are approached, stop the engine.
- Avoid blowing debris towards people, pets, open windows, or vehicles when using unit.
- Review area to be cleared. Look for potential hazards such as stones or metal objects.

Keep a Firm Grip

- To prevent from dropping the unit, hold the handle in one hand, with thumb and fingers encircling the handle.

Keep a Solid Stance

- Maintain footing and balance at all times. Do not stand on slippery, uneven or unstable surfaces. Do not work in odd positions or on ladders. Do not over reach.

Avoid Hot Surfaces

- Keep exhaust area clear of flammable debris. Avoid contact during and immediately after operation.



Equipment

WARNING

Use only approved attachments. Serious injury may result from the use of a non-approved attachment combination. ECHO, INC. will not be responsible for the failure of cutting devices, attachments or accessories which have not been tested and approved by ECHO. Read and comply with all safety instructions listed in this manual.

- ◆ Check unit for loose/missing nuts, bolts, and screws. Tighten and/or replace as needed.
- ◆ Do not use blower if any part is missing or damaged.
- ◆ Have repairs done only by an authorized service dealer.

WARNING

Moving parts can amputate fingers or cause severe injuries. Keep hands, clothing and loose objects away from all openings.

- ◆ **ALWAYS** stop engine, disconnect spark plug, and make sure all moving parts have come to a complete stop before removing obstructions, clearing debris, or servicing unit.
- ◆ **DO NOT** start or operate unit unless all guards and protective covers are properly assembled to unit.
- ◆ **NEVER** reach into any opening while the engine is running. Moving parts may not be visible through openings.

WARNING

Periodically Check fuel system (fuel lines, vent, grommet, fuel tank, and fuel cap) for leaks especially if the unit is dropped. If damage or leaks are found, do not use unit, otherwise serious personal injury or property damage may occur. Have unit repaired by an authorized servicing dealer before using.

EMISSION CONTROL (EXHAUST & EVAPORATIVE)

CARB And EPA Emissions Control Information

The emission control system for the engine is EM (engine modification) and, if the second to last character of the Engine Family on the Emission Control Information label (sample below) is "B", "C", "K", or "T", the emission control system is EM and TWC (3-way catalyst). The fuel tank/fuel line emission control system is EVAP (evaporative emissions). Evaporative emissions for California models are only applicable to fuel tanks and fuel feed lines.

An Emission Control Label is located on the engine. (This is an EXAMPLE ONLY, information on label varies by engine FAMILY).

Product Emission Durability (Emission Compliance Period)

The 50 or 300 hour emission compliance period is the time span selected by the manufacturer certifying the engine emissions output meets applicable emissions regulations, provided that approved maintenance procedures are followed as listed in the Maintenance Section of this manual.



DESCRIPTION

PB-580 H

Locate the safety decal(s) on your unit. Make sure the decal(s) is legible and that you understand and follow the instructions on it. If a decal cannot be read, a new one can be ordered from your ECHO dealer. The safety decal is for example only. Your label may appear slightly different.

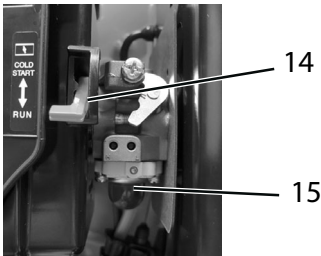
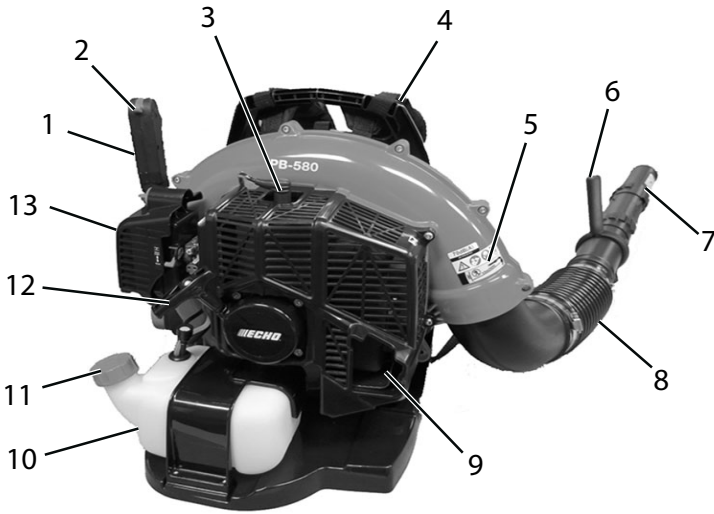

70dB(A)
per ANSI B175.2



1. Handle
2. Throttle Position Lever/stop Switch
3. Spark Plug
4. Shoulder Harness
5. Safety Decal
6. Stick Handle
7. Blower Pipes
8. Flexible Pipes
9. Spark Arrestor Muffler (with or without Catalyst)
10. Fuel Tank
11. Fuel Tank Cap
12. Recoil Starter Handle
13. Air Cleaner
14. Choke
15. Purge Bulb

PB-580T

Locate the safety decal(s) on your unit. Make sure the decal(s) is legible and that you understand and follow the instructions on it. If a decal cannot be read, a new one can be ordered from your ECHO dealer. The safety decal is for example only. Your label may appear slightly different.

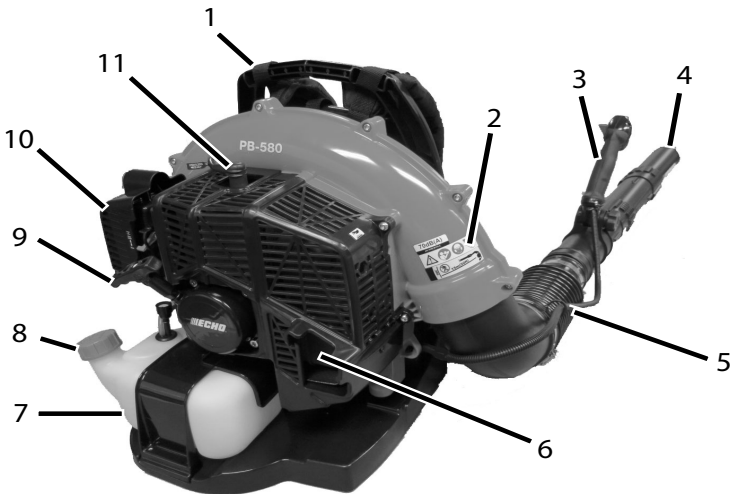
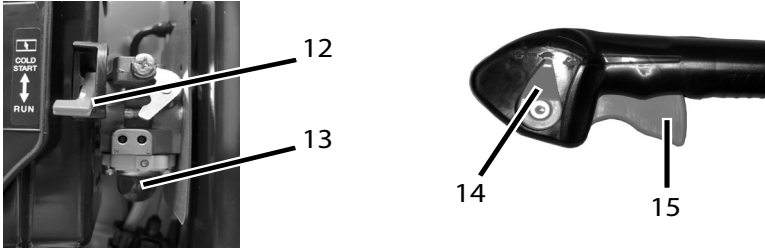

1. Shoulder Harness
2. Safety Decal
3. Throttle Control
4. Blower Pipes
5. Flexible Pipes
6. Spark Arrestor Muffler (with or without Catalyst)
7. Fuel Tank
8. Fuel Tank Cap
9. Recoil Starter Handle
10. Air Cleaner
11. Spark Plug
12. Choke
13. Purge Bulb
14. Throttle Position Lever
15. Throttle Switch

CONTENTS

The ECHO product you purchased has been factory pre-assembled for your convenience. Due to packaging restrictions, some assembly may be necessary.

After opening the carton, check for damage. Immediately notify your retailer or ECHO Dealer of damaged or missing parts. Use the contents list to check for missing parts.

PB-580 H

- 1 Power Head
- 1 Flex Pipe
- 1 Pipe With Swivel
- 1 Straight Pipe
- 1 Straight Pipe With Decal
- 1 Quick Start Guide
- 1 Warranty Statement
- 2 Clamps With Screws
- 1 Stick Handle
- 1 Bolt 6 x 45 mm
- 1 Washer 6 mm
- 1 Wing nut

PB-580 T

- 1 Power Head
- 1 Flex Pipe
- 1 Pipe With Swivel
- 1 Straight Pipe
- 1 Straight Pipe With Decal
- 1 Quick Start Guide
- 1 Warranty Statement
- 2 Clamps With Screws

ASSEMBLY

PB-580 H

WARNING

Never perform maintenance or assembly procedures with engine running or serious personal injury may result.

Install Blower Pipes and Stick Handle

1. Assemble clamps (A) onto both ends of flexible pipe (B).

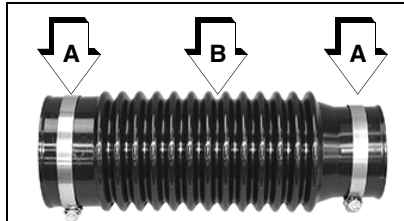

2. Assemble straight pipe with swivel (C) into flexible pipe (B).
3. Assemble flexible pipe (B) to elbow (D) on blower and tighten clamps (A).

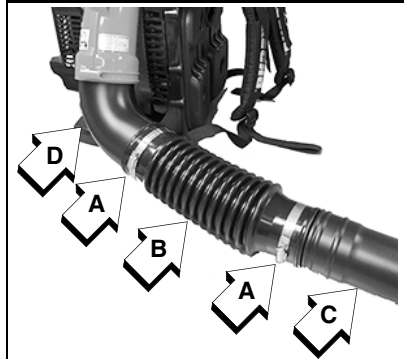

Note: A light lubricant may be used to ease assembly of flexible pipe to blower elbow.

4. Loosen wing nut (E) completely and expand stick handle clamp (F). Align notches (G) in handle clamp with tabs (H).
5. Slide stick handle onto swivel pipe (C). Stick handle (F) should be angled away from operator.
6. Position stick handle (F) for comfortable operation. Tighten wing nut (E).

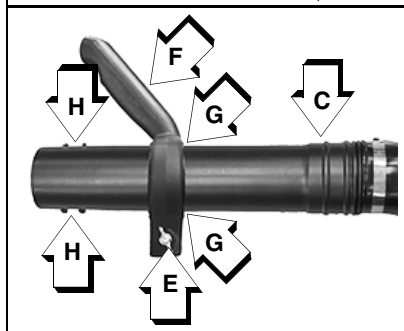

7. Assemble straight pipe (J) onto swivel pipe (C), until you feel light resistance. Hold swivel pipe and turn straight pipe clockwise, engaging positive locking channels, until connection is firm. Do not force connection.
8. Assemble straight pipe with decal (K) to straight pipe (J) as in step 7.

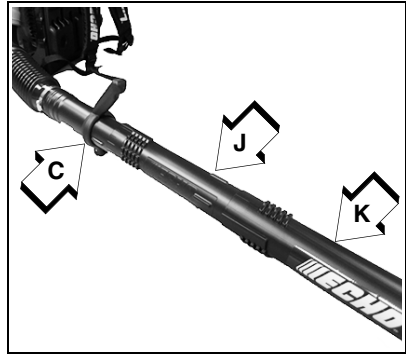

Note: Blower use will eventually loosen pipe connections. Exclusive positive locking system allows pipes to be tightened. If loosening occurs, remove two straight pipes and install according to instructions 7 & 8.

PB-580T

⚠ WARNING

Never perform maintenance or assembly procedures with engine running or serious personal injury may result.

Install Blower Pipes

1. Assemble clamps (A) and (G) onto both ends of flexible pipe (B).

Note: Clamp with cable guide loop (G) fits elbow end of flexible pipe.

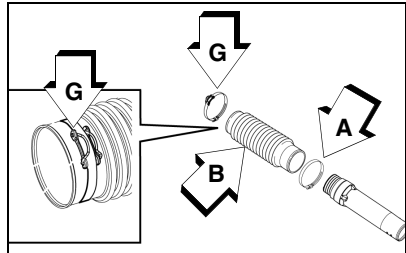

Note: Anti-static wire before installation.

- 2. Route anti-static wire below fan housing and clip wire into throttle cable retaining clip (X). Position wire outside blower elbow.

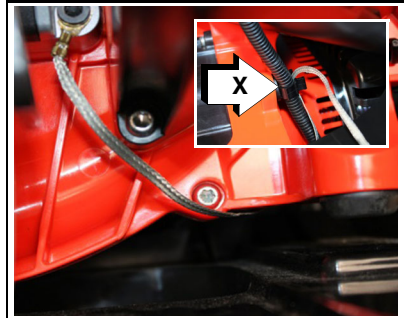

- 3. Insert anti-static wire through flex tube. Leave enough slack in anti-static wire to allow for full rotation of elbow.

Note: A light lubricant may be used to ease assembly of flexible pipe to blower elbow.



- 4. Assemble flexible pipe to elbow (D) on blower. Position clamp with cable guide loop (G) on outside of flexible pipe and tighten clamp.

Note: Hang handle freely from blower to assure throttle cable is not twisted before installing handle (E).

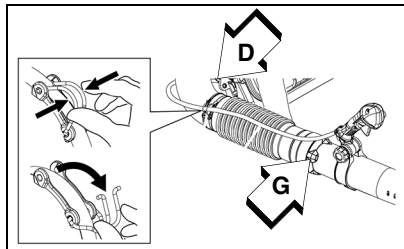

5. Position throttle cable along the outside of elbow. Loosen knob (H) on handle (E). Align notches in handle with tabs (F) and install onto swivel pipe (C) past long ridges in pipe.

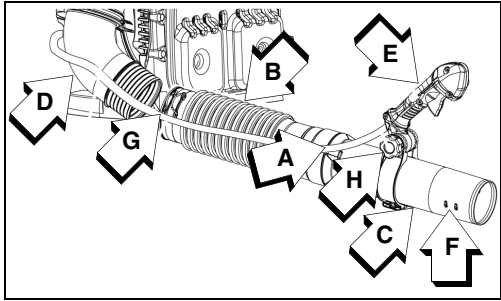

6. Insert anti-static wire through swivel pipe (wire will hang freely in pipe).
7. Assemble swivel pipe into flexible pipe and tighten clamp (A).
8. Clip throttle cable into throttle cable guide loop.
9. Move handle (E) to desired position. Tighten knob (H) hand tight.

10. Assemble straight pipe (K) onto swivel pipe, until you feel light resistance. Hold swivel pipe and turn straight pipe clockwise, engaging positive locking channels, until connection is firm. Do not force connection.

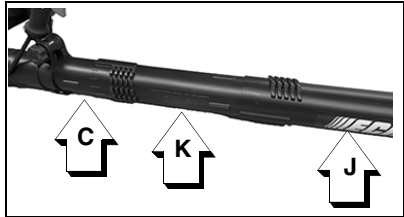

11. Assemble straight pipe with decal (J) to straight pipe as in step 10.

Note: Blower use will eventually loosen pipe connections. Exclusive positive locking system allows pipes to be tightened. If loosening occurs, remove two straight pipes and install according to instructions 10 & 11.

OPERATION

 WARNING

Moving parts can amputate fingers or cause severe injuries. Keep hands, clothing and loose objects away from all openings. Always stop engine, disconnect spark plug, and make sure all moving parts have come to a complete stop before removing obstructions, clearing debris, or servicing unit. Blower housing may contain shredder blades and other sharp edges that can cause serious injuries if touched, even if engine is off and blades are not moving. Wear gloves to protect hands from sharp edges and hot surfaces.

 WARNING

Operation of this equipment may create sparks that can start fires around dry vegetation. This unit is equipped with a spark arrestor to prevent discharge of hot particles from the engine. Contact local fire authorities for laws or regulations regarding fire prevention requirements.

 WARNING

Engine exhaust IS HOT, and contains Carbon Monoxide (CO), a poison gas. Breathing CO can cause unconsciousness, serious injury, or death. Exhaust can cause serious burns. ALWAYS position unit so that exhaust is directed away from your face and body.

 WARNING

- ◆ This blower should be used for clearing leaves, grass, debris, and dust in yards, gardens, driveways, and parking lots only.
- ◆ Always maintain a direct, clear line of site to the unit and the work being performed.
- ◆ Always be alert for changes in operation of unit.
- ◆ Always shut engine off before transporting unit to new location.
- ◆ Always secure the unit during transportation to prevent turnover, fuel spillage, and damage to the unit.

Fuel

 **WARNING**

Diesel fuels and alternative fuels, such as E-15 (15% ethanol), E-85 (85% ethanol) or any fuels not meeting ECHO requirements are NOT approved for use in ECHO 2-stroke gasoline engines. Use of diesel or alternative fuels may cause performance problems, loss of power, overheating, fuel vapor lock, and unintended machine operation, including, but not limited to, improper clutch engagement. Diesel or alternative fuels may also cause premature deterioration of fuel lines, gaskets, carburetors and other engine components.

Fuel Requirements

Gasoline - Use 89 Octane [R+M/2] (mid grade or higher) gasoline known to be good quality. Gasoline may contain up to 10% Ethanol (grain alcohol) or 15% MTBE (methyl tertiary-butyl ether). Gasoline containing methanol (wood alcohol) is **NOT** approved. Use of ECHO branded fuel is recommended to extend engine life in all air-cooled 2-stroke and 2/4-stroke hybrid engines.

Two Stroke Oil - A two-stroke engine oil, such as ECHO branded 2-stroke oils, meeting ISO-L-EGD (ISO/CD 13738) and J.A.S.O. FD Standards must be used. ECHO branded 2-stroke oils meet these standards. Engine problems due to inadequate lubrication caused by failure to use an ISO-L-EGD (ISO/CD 13738) and J.A.S.O. M345-FD certified oil will void the two-stroke engine warranty.

 **WARNING**

2-Stroke engine oil contains petroleum distillates and other additives that may be harmful if swallowed. Heated oil can release vapors that can cause flash fire, or ignite with explosive force. Read and follow the oil manufacturer's instructions, and observe all safety warnings and precautions for handling flammable liquids. For more detailed safety and first aid information, visit www.echo-usa.com for a copy of the Material Safety Data Sheet.

- ◆ **KEEP OUT OF REACH OF CHILDREN.**
- ◆ **If swallowed, do not induce vomiting. CALL PHYSICIAN OR A POISON CONTROL CENTER IMMEDIATELY.**
- ◆ **WEAR SAFETY GLASSES when mixing or handling.**

- ◆ AVOID repeated or prolonged skin contact.
- ◆ AVOID inhaling oil mists or vapors.

NOTICE

ECHO branded 2-stroke oils may be mixed at 50:1 ratio for application in all ECHO engines sold in the past regardless of ratio specified in those manuals.

Handling Fuel

DANGER

Fuel is VERY flammable. Use extreme care when mixing, storing or handling, or serious personal injury may result.

- ◆ ***Use an approved fuel container. Mark fuel containers as containing 2-stroke mixture fuel.***
- ◆ ***DO NOT smoke near fuel.***
- ◆ ***DO NOT allow flames or sparks near fuel.***
- ◆ ***Fuel tanks/cans may be under pressure. Always loosen fuel caps slowly allowing pressure to equalize.***
- ◆ ***NEVER refuel a unit when the engine is HOT or RUNNING!***
- ◆ ***DO NOT fill fuel tanks indoors. ALWAYS fill fuel tanks outdoors over bare ground.***
- ◆ ***DO NOT overfill fuel tank. Wipe up spills immediately.***
- ◆ ***Securely tighten fuel tank cap and close fuel container after refueling.***
- ◆ ***Inspect for fuel leakage. If fuel leakage is found, do not start or operate unit until leakage is repaired.***
- ◆ ***Move at least 3 m (10 ft.) from refueling location before starting the engine.***

DANGER

Gasoline vapor is heavier than air, and can travel along the ground to nearby sources of ignition such as electrical motors, pilot lights, and hot or running engines. Vapors ignited by an ignition source can flash back to the fuel container, resulting in an explosion, fire, serious or fatal injuries, and extensive property damage.

Mixing Instructions

1. Fill an approved fuel container with half of the required amount of gasoline.
2. Add the proper amount of 2-stroke oil to gasoline.
3. Close container and shake to mix oil with gasoline.
4. Add remaining gasoline, close fuel container, and remix.

| Fuel to Oil Mix – 50:1 Ratio | | | |
|------------------------------|--------|--------|-----|
| US | | Metric | |
| Gas | Oil | Gas | Oil |
| gal. | fl.oz. | L | cc |
| 1 | 2.6 | 5 | 100 |
| 2 | 5.2 | 10 | 200 |
| 5 | 13 | 25 | 500 |

NOTICE

Spilled fuel is a leading cause of hydrocarbon emissions. Some locations may require the use of automatic fuel shut-off containers to reduce fuel spillage.

Storage - Fuel storage laws vary by locality. Contact your local government for the laws affecting your area. As a precaution, store fuel in an approved, airtight container. Store in a well-ventilated, unoccupied building, away from sparks and flames.

- Empty the fuel tank prior to storing the unit. Return unused fuel to an approved fuel storage container.

NOTICE

Stored fuel ages. Do not mix more fuel than you expect to use in 30 days, 90 days when a fuel stabilizer is added.

NOTICE

Stored two-stroke fuel may separate. ALWAYS shake fuel container thoroughly before each use.

NOTICE

Used oil and gasoline, and soiled towels are hazardous waste materials. Disposal laws vary by locality.

Fuel

WARNING

Diesel fuels and alternative fuels, such as E-15 (15% ethanol), E -85 (85% ethanol) or any fuels not meeting ECHO requirements are NOT approved for use in ECHO 2-stroke gasoline engines. Use of diesel or alternative fuels may cause performance problems, loss of power, overheating, fuel vapor lock, and unintended machine operation, including, but not limited to, improper clutch engagement. Diesel or alternative fuels may also cause premature deterioration of fuel lines, gaskets, carburetors and other engine components.

Fuel Requirements

Gasoline - Use 89 Octane [R+M/2] (mid grade or higher) gasoline known to be good quality. Gasoline may contain up to 10% Ethanol (grain alcohol) or 15% MTBE (methyl tertiary-butyl ether). Gasoline containing methanol (wood alcohol) is **NOT** approved. Use of ECHO branded fuel is recommended to extend engine life in all air-cooled 2-stroke and 2/4-stroke hybrid engines.

Two Stroke Oil - A two-stroke engine oil, such as ECHO branded 2-stroke oils, meeting ISO-L-EGD (ISO/CD 13738) and J.A.S.O. FD Standards must be used. ECHO branded 2-stroke oils meet these standards. Engine problems due to inadequate lubrication caused by failure to use an ISO-L-EGD (ISO/CD 13738) and J.A.S.O. M345-FD certified oil will void the two-stroke engine warranty.

WARNING

2-Stroke engine oil contains petroleum distillates and other additives that may be harmful if swallowed. Heated oil can release vapors that can cause flash fire, or ignite with explosive force. Read and follow the oil manufacturer's instructions, and observe all safety warnings and precautions for handling flammable liquids. For more detailed safety and first aid information, visit www.echo-usa.com for a copy of the Material Safety Data Sheet.

- ◆ **KEEP OUT OF REACH OF CHILDREN.**
- ◆ **If swallowed, do not induce vomiting. CALL PHYSICIAN OR A POISON CONTROL CENTER IMMEDIATELY.**
- ◆ **WEAR SAFETY GLASSES when mixing or handling.**

- ◆ AVOID repeated or prolonged skin contact.
- ◆ AVOID inhaling oil mists or vapors.

NOTICE

ECHO branded 2-stroke oils may be mixed at 50:1 ratio for application in all ECHO engines sold in the past regardless of ratio specified in those manuals.

Handling Fuel

DANGER

Fuel is VERY flammable. Use extreme care when mixing, storing or handling, or serious personal injury may result.

- ◆ Use an approved fuel container. Mark fuel containers as containing 2-stroke mixture fuel.
- ◆ DO NOT smoke near fuel.
- ◆ DO NOT allow flames or sparks near fuel.
- ◆ Fuel tanks/cans may be under pressure. Always loosen fuel caps slowly allowing pressure to equalize.
- ◆ NEVER refuel a unit when the engine is HOT or RUNNING!
- ◆ DO NOT fill fuel tanks indoors. ALWAYS fill fuel tanks outdoors over bare ground.
- ◆ DO NOT overfill fuel tank. Wipe up spills immediately.
- ◆ Securely tighten fuel tank cap and close fuel container after refueling.
- ◆ Inspect for fuel leakage. If fuel leakage is found, do not start or operate unit until leakage is repaired.
- ◆ Move at least 3 m (10 ft.) from refueling location before starting the engine.

DANGER

Gasoline vapor is heavier than air, and can travel along the ground to nearby sources of ignition such as electrical motors, pilot lights, and hot or running engines. Vapors ignited by an ignition source can flash back to the fuel container, resulting in an explosion, fire, serious or fatal injuries, and extensive property damage.

Mixing Instructions

1. Fill an approved fuel container with half of the required amount of gasoline.
2. Add the proper amount of 2-stroke oil to gasoline.
3. Close container and shake to mix oil with gasoline.
4. Add remaining gasoline, close fuel container, and remix.

| Fuel to Oil Mix – 50:1 Ratio | | | |
|------------------------------|--------|--------|-----|
| US | | Metric | |
| Gas | Oil | Gas | Oil |
| gal. | fl.oz. | L | cc |
| 1 | 2.6 | 5 | 100 |
| 2 | 5.2 | 10 | 200 |
| 5 | 13 | 25 | 500 |

NOTICE

Spilled fuel is a leading cause of hydrocarbon emissions. Some locations may require the use of automatic fuel shut-off containers to reduce fuel spillage.

Storage - Fuel storage laws vary by locality. Contact your local government for the laws affecting your area. As a precaution, store fuel in an approved, airtight container. Store in a well-ventilated, unoccupied building, away from sparks and flames.

- Empty the fuel tank prior to storing the unit. Return unused fuel to an approved fuel storage container.

NOTICE

Stored fuel ages. Do not mix more fuel than you expect to use in 30 days, 90 days when a fuel stabilizer is added.

NOTICE

Stored two-stroke fuel may separate. ALWAYS shake fuel container thoroughly before each use.

NOTICE

Used oil and gasoline, and soiled towels are hazardous waste materials. Disposal laws vary by locality.

Starting Cold Engine

- Recoil starter: Use short pulls - only 1/2- 2/3 of rope length for starting. Do not allow the rope to snap back in. Always hold the unit firmly.
- (PB-580H): Rotate spring loaded throttle arm downward to a comfortable operating position.

1. Throttle Lever

Move throttle lever (A) to IDLE position.

2. Choke

Move choke (B) UP to COLD START () position.

3. Purge Bulb

Pump purge bulb (C) until fuel is visible. Pump bulb an additional 4 or 5 times.

4. Recoil Starter

Pull recoil starter handle (D) until engine fires, or a maximum of 5 pulls

5. Choke

After engine fires (or 5 pulls), move choke lever back to RUN () position, then pull starter handle/rope until engine starts and runs. Allow unit to warm up at idle for several minutes.

Note: If engine does not start with choke in "RUN" position after 5 pulls, move choke to COLD START () position, and repeat steps 3- 5.

6. Throttle Lever

Allow engine to warm up for several minutes before use.

7. Throttle Lever

After engine warm-up, move throttle lever gradually to increase engine RPM to desired operating speed.

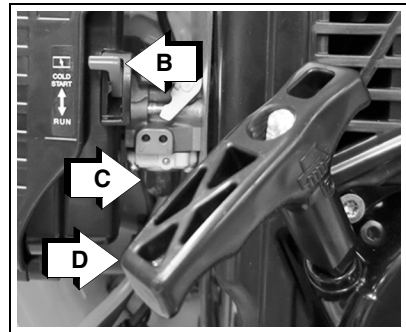
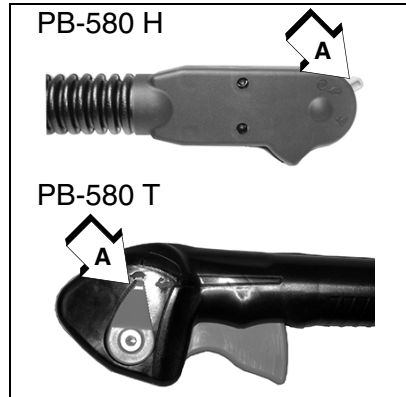

Starting Warm Engine

The starting procedure is the same as Cold Start except DO NOT close the choke.v

1. *Throttle Lever*
Move throttle lever (A) to IDLE position.
2. *Purge Bulb*
Pump purge bulb (C) until fuel is visible. Pump bulb an additional 4 or 5 times.

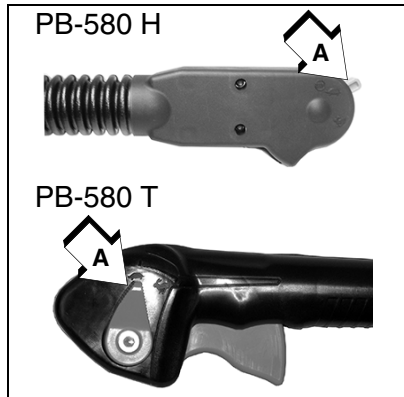

3. *Recoil Starter*
Pull recoil starter handle (D) and engine should start. Do not use choke (B)

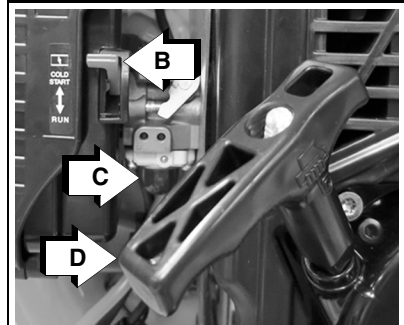

Note: If engine does not start after 5 pulls, use cold start procedures.

Stopping Engine

- **PB-580 H**

1. *Throttle Lever*
Move throttle lever (A) to IDLE position and allow engine to return to idle before shutting off engine.
2. *Throttle Lever*
Move throttle lever (A) to "O" (STOP) position.

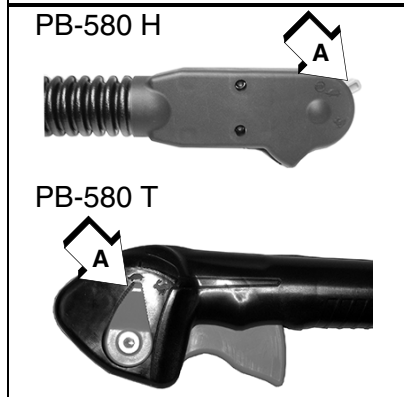

- PB-580 T1. *Throttle Lever*

Release throttle trigger. Move Throttle Lever (A) forward to idle position and allow engine to return to idle before shutting off engine.

2. *Throttle Lever*

Move Throttle Lever (A) all the way forward to STOP position.

 **WARNING**

If engine does not stop when stop switch is moved to STOP position, close choke - COLD START position - to stall engine. Have your dealer repair stop switch before using unit again.

Operating Blower **WARNING**

Engine exhaust IS HOT, and contains Carbon Monoxide (CO), a poison gas. Breathing CO can cause unconsciousness, serious injury, or death. Exhaust can cause serious burns. ALWAYS position unit so that exhaust is directed away from your face and body.

 **WARNING**

Always wear safety glasses, hearing protection and a face filter mask or serious personal injury may result. Do not point the blower pipe in the direction of people or pets.

NOTICE

Use reduced speed only when performing light-duty tasks or to comply with local noise regulations. Continuous low speed operation may allow fuel/oil residue to build-up on the piston and cause rapid build-up of carbon on the spark arrestor screen, resulting in overheating and engine damage. To reduce harmful build-up, run engine at wide open throttle for at least 5 minutes every hour, and inspect/clean the spark arrestor screen after approximately 40 hours of operation.

Read the Safety Section carefully.

NOTICE

To avoid engine damage due to over-revving, do not block blower pipe.

- 1. Use only during appropriate hours. Contact your local government for the ordinances affecting your area.
- 2. To reduce sound levels, limit the number of pieces of equipment used at any one time.
- 3. Allow the engine to warm up at a fast idle for a few minutes.

4. PB-580 H

Set engine speed with throttle lever (A).

PB-580 T

Control engine speed with throttle trigger (B), or for continuous use, set engine speed with throttle lever (A).

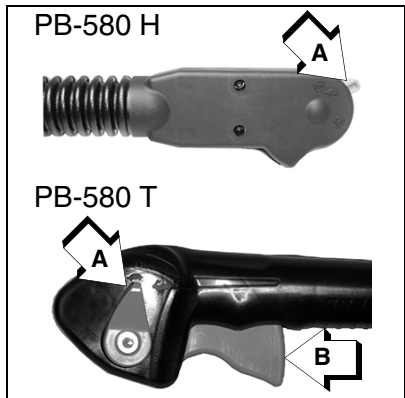

- 5. Use lower speed to blow dry leaves from walks, patios and drives. Use rakes and brooms to loosen debris before blowing.
- 6. Additional speed may be necessary to clean grass and leaves from a lawn or flower bed.
- 7. Higher speed may be necessary to move gravel, dirt, snow, bottles or cans from a driveway, street, parking lot or stadium.
- 8. Always stop unit using stop engine procedure.

Note: Never use a higher speed setting than necessary to perform a task. Remember, the higher the engine speed, the louder the blower noise.

- 9. Minimize dust by using blower at lower speeds or dampen surface with water. Blower can be used to clean most surfaces when water conservation is desired.
- 10. Use the full blower pipe configuration when blowing.
- 11. After using blowers and other equipment, CLEAN UP! Dispose of debris in trash receptacles.

⚠ CAUTION

Contacting blower pipe tip on abrasive surfaces can create sharp cutting edges and can result in personal injury if touched. Do not scrape or drag blower pipe tip when operating or transporting unit. Replace blower pipe assembly if protective metal ring is worn, cracked or deformed.

Cold Weather Operation**Plug**

For operation in cold weather, install plug in cold weather position (C), otherwise icing can occur.

For operation in normal weather, install plug in warm weather position (D), otherwise over heating can occur.

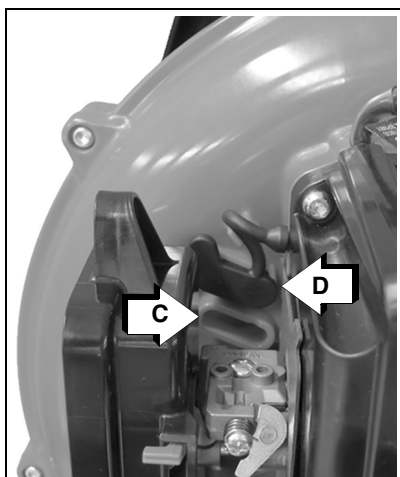
**Intake Cover (optional)**

In cold weather, intake cover can be installed for operator comfort. Intake cover is not included.

1. Remove back cushion (A) from frame.

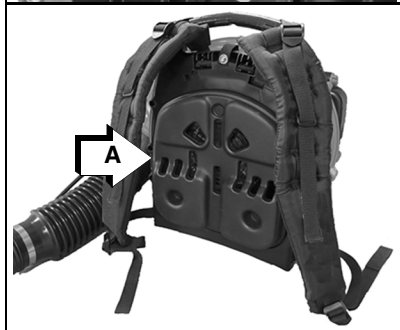

2. Install intake cover (B) on frame over air intake.
3. Install back cushion (A) to frame over intake cover.

Note: Blower performance may be reduced slightly.

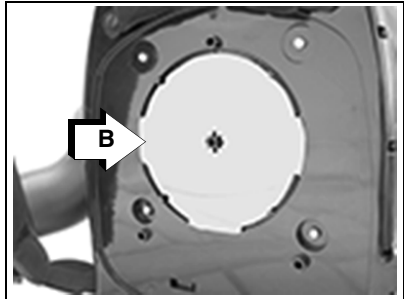

Adjust the Harness

1. Loosen upper and lower buckles (A), then put blower on your back.
2. Pull strap (B) downward to adjust position of blower.
3. Pull (C) to adjust angle between your back and the blower.

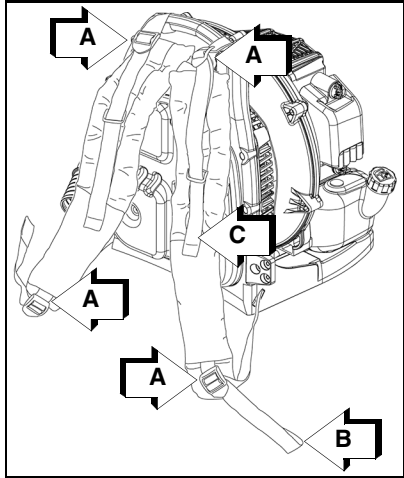

MAINTENANCE

 **WARNING**

Moving parts can amputate fingers or cause severe injuries. Keep hands, clothing and loose objects away from all openings. Always stop engine, disconnect spark plug, and make sure all moving parts have come to a complete stop before removing obstructions, clearing debris, or servicing unit. Allow unit to cool before performing service. Wear gloves to protect hands from sharp edges and hot surfaces.

 **WARNING**

Operating a poorly maintained unit can result in serious injuries to operator or bystanders. Always follow all maintenance instructions as written, otherwise serious personal injury may result.

Your unit is designed to provide many hours of trouble free service. Regular scheduled maintenance will help your unit achieve that goal. If you are unsure or are not equipped with the necessary tools, we recommend that you take your unit to a Servicing Dealer for maintenance. To help you decide whether you want to DO-IT-YOURSELF or have the Dealer do it, each maintenance task has been graded. If the task is not listed, see your Dealer for repairs.

NOTICE

The use of emission control components other than those specifically designed for this unit is a violation of federal law.

Skill Levels

Level 1 = Easy to do. Common tools may be required.

Level 2 = Moderate difficulty. Some specialized tools may be required.

Level 3 = See your dealer.

Click [HERE](#) or go to <http://www.echo-usa.com/products/maintenance-kit>

or

[HERE https://www.shindaiwa-usa.com/you-can.aspx](https://www.shindaiwa-usa.com/you-can.aspx)

For information about maintenance kits.

Maintenance Intervals

| COMPONENT/SYSTEM | MAINTENANCE PROCEDURE | SKILL LEVEL |
|----------------------------|--------------------------------------|-------------|
| Daily or Before Use | | |
| Air Filter | Inspect/Clean ¹ | 1 |
| Choke Shutter | | |
| Fuel System | Inspect | |
| Cooling System | Inspect/Clean | 2 |
| Recoil Starter Rope | Inspect/Clean ¹ | 1 |
| Screws/Nuts/Bolts | Inspect/Tighten/Replace ¹ | |
| Every Refuel | | |
| Fuel System | Inspect ¹ | 1 |
| Cooling System | Inspect/Clean | 2 |
| 3 Months | | |
| Air Filter | Replace ¹ | 1 |
| Fuel Filter | Inspect ¹ | |
| Fuel Cap Gasket | | |
| Spark Plug | Inspect/Clean/Replace ¹ | 2 |
| Muffler Spark Arrestor | | |
| Cylinder Exhaust Port | Inspect/Clean/De-carbon | |
| Yearly | | |
| Fuel Filter | Inspect/Replace ¹ | 1 |
| Fuel Cap Gasket | Replace ¹ | |

IMPORTANT NOTE - Time intervals shown are maximum. Actual use and your experience will determine the frequency of required maintenance.

MAINTENANCE PROCEDURE NOTES:

1. Replacement is recommended based on the finding of damage or wear during inspection.

Air Filter

Level 1.

Parts Required: Tune Up Kit.

1. CLOSE choke (COLD START [] position). This prevents dirt from entering the carburetor throat when the air filter is removed. Brush accumulated dirt from air cleaner area.
2. Remove air filter cover. Brush dirt from inside cover.
3. Remove air filter and lightly brush debris from filter. Replace filter if it is damaged, fuel soaked, very dirty, or the rubber sealing edges are deformed.
4. If filter can be reused, be certain it:
 - Fits tightly in the air filter cavity
 - Is installed with the original side out
5. Install air filter cover.



Fuel Filter

Level 1.

Parts Required: Tune Up Kit.

DANGER

Fuel is VERY flammable. Use extreme care when mixing, storing or handling, or serious personal injury may result.

1. Use a clean rag to remove loose dirt from around fuel cap and empty fuel tank.
2. Pull the fuel line and filter from the tank.
3. Remove the filter from the line and install the new filter.

Note: Federal EPA regulations require all model year 2012 and later gasoline powered engines produced for sale in the United States to be equipped with a special low permeation fuel supply hose between the carburetor and fuel tank. When servicing model year 2012 and later equipment, only fuel supply hoses certified by EPA can be used to replace the original equipment supply hose. Fines up to \$37,500 may be enforced for using an un-certified replacement part.

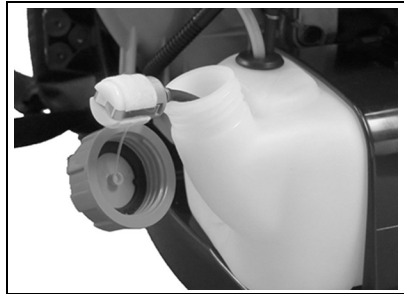

Spark Plug

Level 2.

Parts Required: Tune Up Kit.

NOTICE

Use only NGK BPM8Y spark plug (BPMR8Y in Canada) otherwise severe engine damage may occur.

1. Remove spark plug and check for fouling, worn and rounded center electrode.
2. Clean the plug or replace with a new one. **DO NOT** sand blast to clean. Remaining sand will damage engine.
3. Adjust spark plug gap by bending outer electrode.
4. Tighten spark plug to 150-170 kgf • cm (130-150 in • lbf).

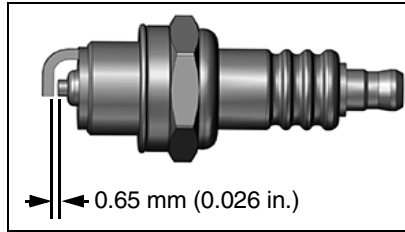

Cooling System

Level 2.

NOTICE

To maintain proper engine operating temperatures, cooling air must pass freely through the cylinder fin area. This flow of air carries combustion heat away from the engine.

Overheating and engine seizure can occur when:

- Air intakes are blocked, preventing cooling air from reaching the cylinder.
- Dust and grass build up on the outside of the cylinder. This build up insulates the engine and prevents the heat from leaving.

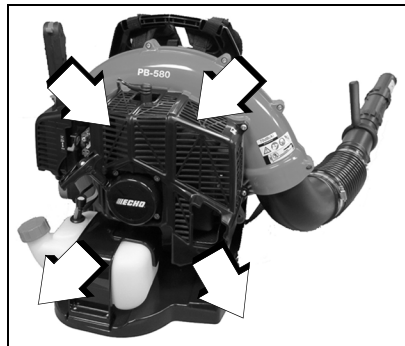

Removal of cooling passage blockages or cleaning of cooling fins is considered "Normal Maintenance." Any failure attributed to lack of maintenance is not warranted.

Cleaning Grill

1. Brush accumulated debris from intake grill between backpack frame and blower housing.

Cleaning Cylinder Fins

1. Remove spark plug.
2. Remove starter
3. Remove engine cover.
4. Clean cylinder fins (A) to allow cooling air to pass freely
5. Assemble components in reverse order.

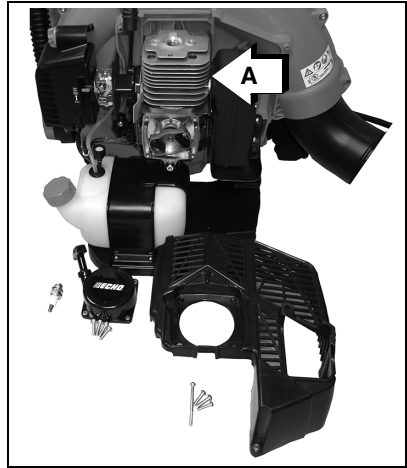

Exhaust System

Spark Arrestor Screen

Level 2.

Parts Required: Spark Arrestor Screen, Gasket

NOTICE

Carbon deposits in muffler will cause a drop in engine output and overheating. Spark arrestor screen must be checked periodically.

1. Remove spark plug.
2. Remove starter.
3. Remove engine cover.
4. Place piston at Top Dead Center (TDC) to prevent carbon/dirt from entering cylinder.
5. Remove spark arrestor cover (A), gasket (B) and spark arrestor screen (C) from muffler.
6. Clean carbon deposits from muffler components.

Note: When cleaning carbon deposits, be careful not to damage the catalytic element inside muffler.

7. Replace screen if it is cracked, plugged, or has holes burned through.
8. Replace gasket.
9. Assemble components in reverse order.

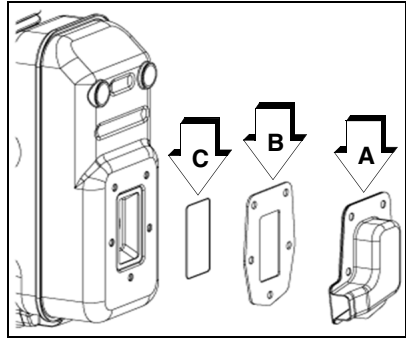

Exhaust Port Cleaning

Level 2.

Parts Required: Heat Shield

1. Remove spark plug.
2. Remove starter
3. Remove engine cover.
4. Place piston at top dead center. Remove muffler (A) heat shield (B).
5. Use a wood or plastic scraping tool to clean deposits from cylinder exhaust port.

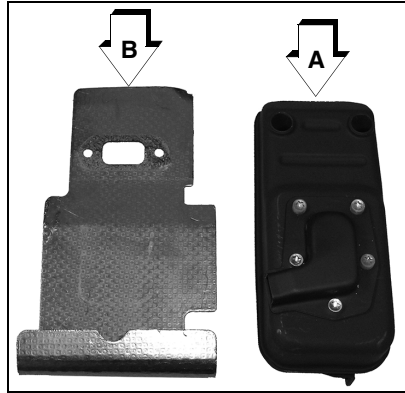

NOTICE

Never use a metal tool to scrape carbon from the exhaust port. Do not scratch the cylinder or piston when cleaning the exhaust port. Do not allow carbon particles to enter the cylinder.

6. Replace heat shield.

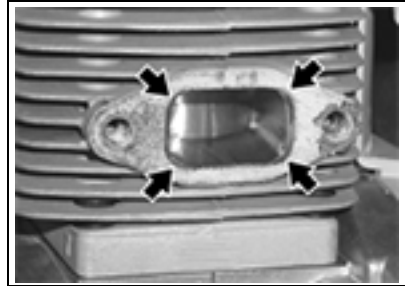

NOTICE

Assure heat shield is installed correctly behind rib (A) and in front of rib (B) in fan case.

7. Install muffler.
8. Tighten muffler mounting bolts (or nuts) to 90-110 kgf • cm (80-95 in • lbf).
9. Assemble components in reverse order.
10. Start engine, and warm to operating temperature.
11. Stop engine, and re-tighten mounting bolts (or nuts) to specifications.

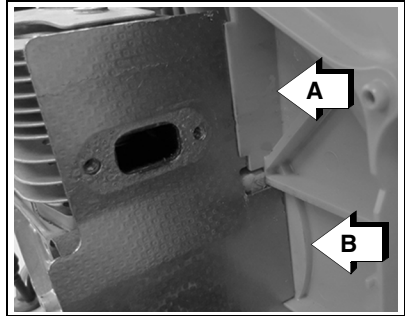

Carburetor Adjustment

Engine Break-In

New engines must be operated a minimum duration of two tanks of fuel break-in before carburetor adjustments can be made. During the break-in period your engine performance will increase and exhaust emissions will stabilize. Idle speed can be adjusted as required.

High Altitude Operation

This engine has been factory adjusted to maintain satisfactory starting, emission, and durability performance up to 1,100 feet above sea level (ASL) (96.0 kPa). To maintain proper engine operation and emission compliance above 1,100 feet ASL the carburetor may need to be adjusted by an authorized service dealer.

NOTICE

If the engine is adjusted for operation above 1,100 feet ASL, the carburetor must be re-adjusted when operating the engine below 1,100 feet ASL, otherwise severe engine damage may result.

Level 2.

Note: Every unit is run at the factory and the carburetor is set in compliance with emission regulations. Carburetor adjustments, other than idle speed, must be performed by an authorized dealer.

Idle Adjustment

Before adjustment make sure that:

- Air filter is clean and properly installed.
 - Spark arrestor screen and muffler are free of carbon.
 - Blower pipes are installed.
1. Start engine, run at idle for one minute.
 2. Complete warm up by running at full throttle for 5 minutes, operating choke twice to clear air from carburetor chambers.
 3. Check idle speed and reset if necessary. If a tachometer is available, idle speed screw (A) should be set to the specifications found on "Specifications" Page of this manual. Turn idle screw (A) clockwise to increase idle speed; counter clockwise to decrease idle speed.

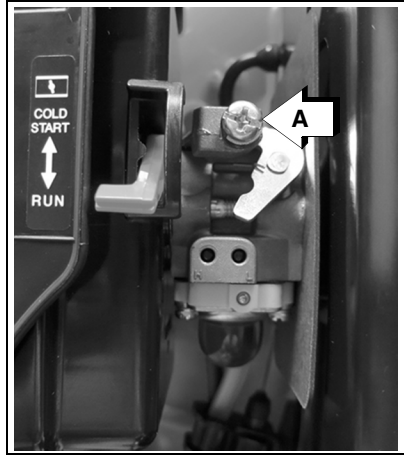

Throttle Cable Adjustment

Level 1

If engine idle speed changes when blower pipe is moved, or engine will not reach full wide open throttle speed, adjust throttle cable.

1. Loosen handle adjustment knob (C) and tilt Tube Throttle handle forward to expose Adjustment Screw (D).

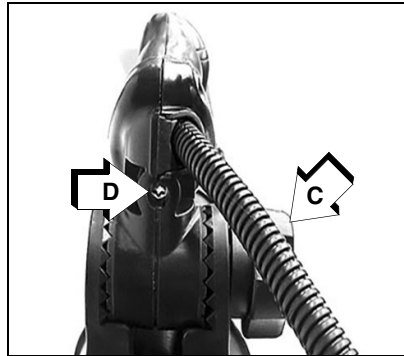

2. Turn Adjustment Screw until Throttle Trigger free play is 4 - 6 mm (3/16-1/4 in.).
3. After adjustment, squeeze and release Throttle Trigger several times to verify Carburetor Throttle Shaft has full range of movement from idle to wide open throttle positions.

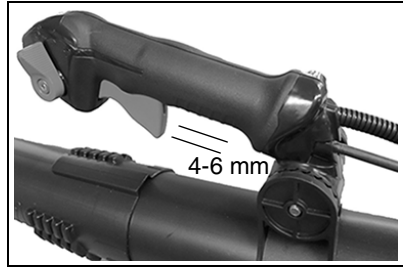

TROUBLESHOOTING

DANGER

Fuel vapors are extremely flammable and may cause fire and/or explosion. Never test for ignition spark by grounding spark plug near cylinder plug hole, otherwise serious personal injury may result.

| ENGINE PROBLEM TROUBLESHOOTING CHART | | | | |
|---|---------------------------|-----------------------|---|---|
| Problem | Check | Status | Cause | Remedy |
| Engine starts hard or Engine does not start | Fuel at carburetor | No fuel at carburetor | Fuel strainer or fuel line obstructed | Clean or replace See your dealer |
| | | Fuel at cylinder | No fuel at cylinder | Carburetor |
| Engine starts hard or Engine does not start | Spark at end of plug wire | | Muffler wet with fuel | Fuel mixture too rich |
| | | Spark at plug | No spark | Ignition at STOP position |
| | | | | Electrical problem |
| | | | Interlock switch | |
| | | | Incorrect gap - Covered with carbon - Fouled with fuel - Plug defective | Adjust to 0.65mm (0.026 in.) Clean or replace plug |

| ENGINE PROBLEM TROUBLESHOOTING CHART | | | | |
|--|-----------------------|---------------------------------|--|--------------------------------|
| Problem | Check | Status | Cause | Remedy |
| Engine runs, but dies or Engine does not accelerate properly | Air filter | Air filter dirty | Normal wear | Clean or replace |
| | Fuel filter | Fuel filter dirty | Contaminants or residue in fuel | Replace filter or replace fuel |
| | Fuel vent | Fuel vent plugged | Contaminated fuel | Clean or replace |
| | Spark plug | Plug dirty or worn | Normal wear | Clean and adjust or replace |
| | Carburetor | Improper adjustment | Vibration | Adjust |
| | Cooling system | Cooling system dirty or plugged | Extended operation in dirty or dusty locations | Clean |
| | Spark arrestor screen | Spark arrestor screen plugged | Normal wear | Replace |
| Engine does not crank | N/A | | Internal engine problem | See your dealer |

STORAGE

WARNING

During operation the muffler or catalytic muffler and surrounding cover become hot. Always keep exhaust area clear of flammable debris during transportation or when storing, otherwise serious property damage or personal injury may result.

Long Term Storage (Over 30 Days)

Do not store your unit for a prolonged period of time (30 days or longer) without performing protective storage maintenance which includes the following:

1. Store unit in a dry, dust free place, out of the reach of children.

DANGER

Do not store in enclosure where fuel fumes may accumulate or reach an open flame or spark.

2. Place the stop switch or lever in the "OFF" position.
3. Remove accumulation of grease, oil, dirt and debris from exterior of unit.
4. Perform all periodic lubrication and services that are required.
5. Tighten all the screws and nuts.
6. Drain fuel tank completely. Press purge bulb 6 -7 times to remove remaining fuel from carburetor then drain the tank again. Close choke, start and run the engine until it stops due to lack of fuel.
7. Allow engine to cool. Remove the spark plug lead from the spark plug. Remove the spark plug. Pour 7 cc (0.25 oz.) of fresh, clean, two-stroke engine oil into the cylinder through the spark plug hole.
8. Pull the recoil starter handle 2-3 times to distribute the oil inside the engine.
9. Observe the piston location through the spark plug hole. Pull the recoil handle slowly until the piston reaches the top of its travel and leave it there.
10. Install the spark plug. Connect the spark plug lead to the spark plug.
11. Remove blower pipe assembly from unit.

SPECIFICATIONS

| MODEL | PB-580 H | PB-580 T |
|---|--|--------------------|
| Length (w/o pipes) | 379 mm (14.92in.) | 379 mm (14.92 in.) |
| Width (w/o pipes) | 537 mm (21.14 in.) | 478 mm (18.82 in.) |
| Height (w/o pipes) | 459 mm (18.07 in.) | |
| Weight (dry) (w/o pipes) | 9.4 kg (20.7 lb.) | 9.3 kg (20.5 lb.) |
| Engine Type | Air cooled, two-stroke, single cylinder gasoline engine | |
| Bore | 46.0 mm (1.81 in.) | |
| Stroke | 35.0 mm (1.38 in.) | |
| Displacement | 58.2 cc (3.55 cu. in.) | |
| Exhaust | Spark arrestor muffler or spark arrestor muffler with catalyst | |
| Carburetor | Diaphragm w/purge pump | |
| Ignition System | Flywheel magneto, capacitor discharge ignition type | |
| Spark Plug | NGK BPM8Y (NGK BPMR8Y in Canada) (Gap 0.65 mm [0.026 in.]) | |
| Fuel | Mixed (Gasoline and Two-stroke Oil) | |
| Gasoline/Oil Ratio | 50:1 | |
| Gasoline | Use 89 Octane unleaded. Do not use fuel containing methyl alcohol, more than 10% ethyl alcohol or 15% MTBE. Do not use alternative fuels such as E-15 or E-85. | |
| Oil | ISO-L-EGD (ISO/CD 13738) and J.A.S.O. M345- <u>FD</u> , two-stroke, air-cooled engine oil. | |
| Fuel Tank Capacity | 1.83 L (62 US fl. oz.) | |
| Starter System | Automatic Recoil Starter, centrifugal type | |
| Idle Speed | 2,700 RPM | |
| Wide Open Throttle Speed (W.O.T.) | 6,550 RPM | |
| Maximum Air Speed w/ pipes | 96.4 m/sec (216 mph) | |
| Air Volume | 14.7 m ³ /min. (517 ft. ³ /min.) | |
| Sound Level at 50 ft. dB(A) scale per ANSI B175.2 | 70 dB(A) | |

PRODUCT REGISTRATION

Thank you for choosing ECHO Power Equipment

Please go to <http://www.echo-usa.com/Warranty/Register-Your-ECHO> to register your new product on-line. It's **FAST** and **EASY!** NOTE: your information will never be sold or misused by ECHO, Inc. Registering your purchase enables us to contact you in the unlikely event of a service update or product recall, and verifies your ownership for warranty consideration.

If you do not have access to the Internet, you can complete the form below and mail to:

ECHO Incorporated, Product Registration, PO Box 1139, Lake Zurich IL 60047.



PRODUCT REGISTRATION CARD : TARJETA DE REGISTRO : CARTE D'ENREGISTREMENT DU PRODUIT

ONLINE OPTION: Register online and save a stamp! You will be alerted of product updates and/or be sent new ECHO product information and special offers. Simply go to: www.echo-usa.com

OPCIÓN POR INTERNET: Regístrese en la página web y ahorre una estampilla. Le alertarán sobre actualizaciones del producto y/o se le enviarán ofertas especiales. Simplemente visite: www.echo-usa.com

OPTION EN LIGNE: Enregistrer en ligne et épargner un timbre! Vous serez informé sur les nouveaux produits ECHO et les mises à jour de produit ainsi que les offres spéciales. Simplement visitez le: www.echo-usa.com

Please Print : Por Favor Escribe Con Letra De Molde : En Lettre Carré S.V.P.

Confidential: Information provided will not be shared or sold

Purchaser's Name : Nombre del Comprador : Nom de l'acheteur

Address : Dirección : Adresse

City : Ciudad : Ville

State : Estado :
Province

Zip Code : Código Postal : Code Postal

E-Mail Address : Dirección De Correo Electrónico : Courriel Électronique

Phone Number : Número De Teléfono : Téléphone

Date of Purchase : Fecha de la Compra :
Date de l'achat

Where Purchased : Nombre del Almacén donde fue Comprado : Lieu d'achat

Model Number : Número del Modelo : No. de modèle Serial Number : Número de Serie : No. de série

Registering your purchase enables us to contact you in the unlikely event of a service update or product recall and verifies your purchase. We will never give your personal information to anyone else. We will contact you if we have a special offer for you or as an advance notice of a service or product recall. We will also contact you if we have a special offer for you or as an advance notice of a service or product recall. L'enregistrement de votre achat nous permettra de vous contacter dans le cas improbable de modifications des instructions d'entretien ou de rappel du produit et vérifier que vous êtes le propriétaire en cas de vol ou de perte.

Primary use of tool: Professional Homeowner Rental Equip.

Uso primario de la herramienta: Profesional Dueño de casa Alquiler

Usage principal: Professionnel Residential Location

Do you wish to receive periodic ECHO product information and special offers

by e-mail? Yes No

¿Desea usted recibir información periódica y ofertas especiales por correo elec-

trónico sobre el producto ECHO? Yes No

Souhaitez-vous recevoir périodiquement de l'information sur les produits

ECHO et les offres spéciales par courrier électronique? Oui Non

Did you visit the ECHO website before purchasing your product?

Yes No

Visitó usted la página web ECHO antes de comprar su producto?

Sí No

Avez-vous visité le site d'ECHO avant de procurer votre produit?

Oui Non

What factor(s) most influenced your purchase?

Performance Price Dealer

Reliability Prior Experience Quality

Friend/Family Brand Warranty

¿Que factor(es) influenció más en su compra?

Funcionamiento Precio Distribuidor

Confiabilidad Experiencia Anterior Calidad

Amigo/Familia Marca Garantía

Quel facteur (facteurs) vous a influencé le plus?

Performance Prix Marchand

Fiabilité Expérience Qualité

Ami/Famille Marque Garantie

ECHO INC., 400 Oakwood Rd., Lake Zurich, IL 60047

1.800.432.ECHO WWW.ECHO-USA.COM

X7572270206 02-2012



H P44713001001 - P44713999999
P48013001001 - P48013999999
T P44813001865 - P44813999999
P48113001865 - P48113999999



ECHO INCORPORATED

400 Oakwood Road
Lake Zurich, IL 60047

www.echo-usa.com