



Operator's Manual 99944200640 Mid-Reach Hedge Trimmer Attachment

FOR MODELS: SRM-2100SB, 2400SB, 210SB, 211SB, 225SB, 260SB, 261SB, PAS-2100, 2400, 2601, 210, 211, 225, 225VP, 225VPB, 230, 231, 260, 261, 265, 266, 280, 2620

WARNING

The engine exhaust from this product contains chemicals known to the State of California to cause cancer, birth defects, or other reproductive harm.

WARNING



Read and understand all provided literature before use. Failure to do so could result in serious injury.

TABLE OF CONTENTS

Introduction	3
Servicing Information	3
Parts/Serial Number.....	3
Service	4
ECHO Consumer Product Support.....	4
Product Registration	4
Additional Literature	4
Safety	4
Manual Safety Symbols and Important Information.....	4
International Symbols	5
Personal Condition and Safety Equipment	7
Equipment.....	11
Description	13
Contents.....	14
Assembly.....	14
Power Head Shaft to Lower Shaft Assembly	14
Operation	15
Hedge Trimming.....	15
Maintenance	16
Skill Levels.....	17
Maintenance Intervals.....	17
Lubrication	18
Blades.....	19
Storage	21
Storage Hook Installation.....	21
Specifications.....	22
Product Registration.....	22

INTRODUCTION

Specifications, descriptions and illustrative material in this literature are as accurate as known at the time of publication, but are subject to change without notice. Illustrations may include optional equipment and accessories, and may not include all standard equipment.



Read and understand all provided literature. Literature contains specifications and information for safety, operation, maintenance, storage, and assembly specific to this product. Scan QR codes for more information.



For additional literature, including safety manuals where applicable, or questions regarding terms used in this manual, visit:

<https://www.echo-usa.com/manuals>

OR



<https://www.shindaiwa-usa.com/manuals>

SERVICING INFORMATION

Parts and Serial Number

Genuine ECHO Parts and Assemblies for your ECHO products are available only from an Authorized ECHO Dealer. When you do need to buy parts always have the Model Number and Serial Number of the unit with you. For future reference write them in the space provided below.

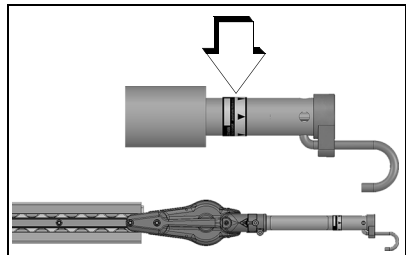

Model No. _____ Serial No. _____

Service

Service of this product during the warranty period must be performed by an Authorized ECHO Service Dealer. For the name and address of the Authorized ECHO Service Dealer nearest you, ask your retailer or call: 1-800-432-ECHO (3246). Dealer information is also available on our Web Site www.echo-usa.com. When presenting your unit for Warranty service/repairs, proof of purchase is required.

ECHO Consumer Product Support

If you require assistance or have questions concerning the application, operation, or maintenance of this product, call the ECHO Consumer Product Support Department at 1-800-432-ECHO (3246) from 8:00 am to 5:00 pm (Central Standard Time) Monday through Friday. Before calling, please know the model and serial number of your unit.

Product Registration

Register your ECHO equipment on-line at www.echo-usa.com or by filling out the product registration sheet included in this manual. Registering your product confirms warranty coverage and provides a direct link to ECHO if we find it necessary to contact you.

Additional Literature

In addition to finding information online, information is available from your Authorized ECHO Service Dealer, or by contacting ECHO Incorporated, 400 Oakwood Road, Lake Zurich, IL 60047, 1-800-432-ECHO (3246).

SAFETY

Manual Safety Symbols and Important Information

Throughout this manual and on the product itself, you will find safety alerts and helpful, informational messages preceded by symbols or key words. The following is an explanation of those symbols and key words and what they mean to you.



The safety alert symbol accompanied by the word “DANGER” calls attention to an act or condition which WILL lead to serious personal injury or death if not avoided.

! WARNING

The safety alert symbol accompanied by the word “WARNING” calls attention to an act or condition which CAN lead to serious personal injury or death if not avoided.

! CAUTION

The safety alert symbol accompanied by the word “CAUTION” calls attention to an act or condition which might lead to minor or moderate personal injury if not avoided.

NOTICE

The enclosed message provides information necessary for the protection of the unit.

Note: This enclosed message provides tips for use, care and maintenance of the unit.















CIRCLE AND SLASH SYMBOL

This symbol means the specific action shown is prohibited. Ignoring these prohibitions can result in serious or fatal injury.

International Symbols

Symbol	Description	Symbol	Description
	Warning, see Operator's Manual		Safety / Alert
	Wear eye, ear and head protection		Finger severing
	Wear hand and foot protection		Rotating cutting attachment
	Wear face shield		Wear slip resistant footwear

Symbol	Description	Symbol	Description
	<p>Keep feet away from blade</p>		<p>Do not operate closer than 15 m (50 ft.) from electrical hazards. Keep bystanders at least 15 m (50 ft.) away</p>
	<p>DO NOT USE BLADES - line head only</p>	 	<p>Beware of thrown objects</p>
	<p>Plan retreat path from falling objects.</p>	 	<p>Hot surface</p>
	<p>DO NOT USE LINE HEAD - blades only</p>		
	<p>Keep bystanders and helpers away 15 m (50 ft.).</p>		
	<p>Beware thrown objects. Wear eye protection.</p>		
		<p>Keep bystanders and helpers away 15 m (50 ft.).</p>	
		<p>Keep bystanders and helpers away 15 m (50 ft.).</p>	

Read the Manuals

- Provide all users of this equipment with the Operator’s Manual and Safety Manual for instructions on Safe Operation.

Clear the Work Area

- Spectators and fellow workers must be warned, and children and animals prevented from coming nearer than 15 m (50 ft.) while the unit is in use.

Keep a Firm Grip

- Hold the front and rear handles with thumbs and fingers encircling the grips.

Keep a Solid Stance

- Maintain footing and balance at all times. Do not stand on slippery, uneven or unstable surfaces. Do not work in odd positions or on ladders. Do not over reach.

Avoid Hot Surfaces

- During operation, the drive shaft housing and attachment bearing housing may become very hot, too hot to touch. Avoid contact during and immediately after operation.



Equipment

 WARNING

Use this attachment with ECHO approved models only. Serious injury may result from the use of this attachment combined with a non approved ECHO product.

- ◆ ***Check unit for loose/missing nuts, bolts, and screws. Tighten and/or replace as needed.***
- ◆ ***Never adjust blades when the engine is operating.***
- ◆ ***Check that the blade assembly is firmly attached and in safe operating condition. Dull, loose or damaged blades should not be used.***

Note: ECHO, INC. will not be responsible for the failure of cutting devices, attachments or accessories which have not been tested and approved by ECHO.

 **WARNING**

Moving parts can amputate fingers or cause severe injuries. Keep hands, clothing and loose objects away from all openings.

- ◆ *ALWAYS stop engine, disconnect spark plug, and make sure all moving parts have come to a complete stop before removing obstructions, clearing debris, or servicing unit.*
- ◆ *DO NOT start or operate unit unless all guards and protective covers are properly assembled to unit.*
- ◆ *NEVER reach into any opening while the engine is running. Moving parts may not be visible through openings.*

DESCRIPTION

Locate the safety decal(s) on your unit. Make sure the decal(s) is legible and that you understand and follow the instructions on it. If a decal cannot be read, a new one can be ordered from your ECHO dealer. Safety label is for example only. Your label may appear slightly different.

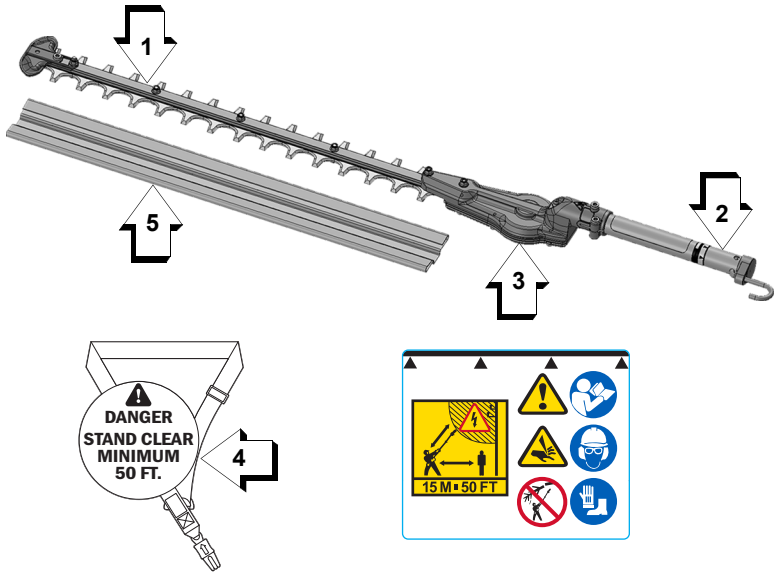

1. BLADES
2. DRIVE SHAFT ASSEMBLY
3. GEAR HOUSING ASSEMBLY
4. SHOULDER HARNESS
5. BLADE COVER

CONTENTS

The ECHO product you purchased has been factory pre-assembled for your convenience. Due to packaging restrictions, some assembly may be necessary.

After opening the carton, check for damage. Immediately notify your retailer or ECHO Dealer of damaged or missing parts. Use the contents list to check for missing parts.

- 1 Mid-Reach Hedge Clipper Attachment
- 1 Blade Cover
- 1 Shoulder Harness
- 1 Storage Hook Assembly
- 1 Operator's Manual

ASSEMBLY

Power Head Shaft to Lower Shaft Assembly



Do not perform maintenance or assembly procedures with engine running.

Parts Required: PAS or SRM-SB Power Head Shaft and Coupling

1. Set Power Head/Shaft Assembly on a level surface.
2. Pull locator pin (A) out, and turn counterclockwise one-quarter turn to lock-out position.
3. Remove storage hook and cap from attachment drive shaft.

Note: Your coupler may appear different than coupler shown.
Earlier model power heads may have shorter couplings.

- 4. Carefully fit attachment drive shaft assembly into coupler (B). Rotate the shaft (C) to make sure the inner lower drive shaft engages the square upper drive shaft socket.

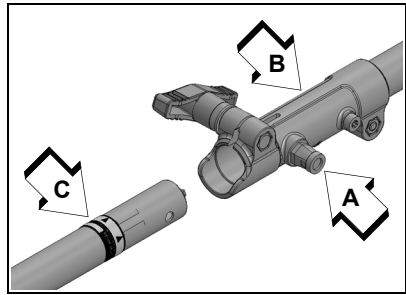

Note: Lower bearing housing and head assembly must be in line with the engine.

Note: Some models have an assembly line decal to assist in assembly.

- 5. Rotate locator pin (A) one-quarter turn clockwise to engage lower shaft hole. Make sure locator pin is fully engaged by rotating the lower drive shaft. Locator pin should snap flush in coupler. Full engagement will prevent further shaft rotation.

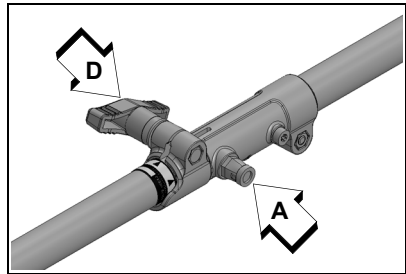

- 6. Secure lower shaft assembly to coupler by tightening clamping knob (D).

OPERATION

! WARNING

Moving parts can amputate fingers or cause severe injuries. Keep hands, clothing and loose objects away from all openings. Always stop engine, disconnect spark plug, and make sure all moving parts have come to a complete stop before removing obstructions, clearing debris, or servicing unit.

Note: Refer to your PAS power source Operator's Manuals for correct engine fueling, starting and stopping instructions.

Hedge Trimming

Shoulder Harness (if included)

1. Loosen harness clamp screw (A).
2. Put harness on and attach it to harness clamp ring (B).
3. Adjust harness for comfortable operation.
4. Tighten harness clamp screw (A).

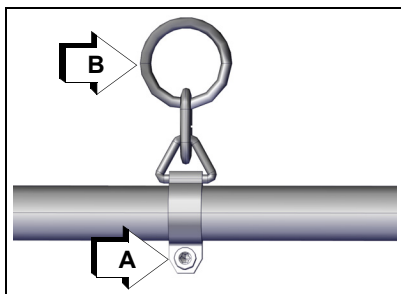

WARNING

Hedge Trimmer blades are very sharp. Touching them may lead to severe personal injury. Avoid touching blades whenever possible, and always wear gloves to protect hands.

WARNING

Never remove hands from unit when blades are moving. The engine continues running even when the blades have stopped due to an obstruction. If this occurs, stop the engine, disconnect ignition cable and remove the obstruction.

1. Always grip throttle handle with right hand and support handle with left hand.
2. Hold trimmer firmly and squeeze throttle trigger to accelerate engine.
3. Tilt trimmer so cutting teeth are angled slightly toward the hedge or shrub and proceed to cut.

WARNING

Gear case becomes extremely hot during use. Wear gloves to protect hands. Otherwise serious personal injury may result.

MAINTENANCE

WARNING

Moving parts can amputate fingers or cause severe injuries. Keep hands, clothing and loose objects away from all openings. Always stop engine, disconnect spark plug, and make sure all moving parts have come to a complete stop before removing obstructions, clearing debris, or servicing unit. Allow unit to cool before performing service. Wear gloves to protect hands from sharp edges and hot surfaces.

WARNING

Operating a poorly maintained unit can result in serious injuries to operator or bystanders. Always follow all maintenance instructions as written, otherwise serious personal injury can result.

Your unit is designed to provide many hours of trouble free service. Regular scheduled maintenance will help your unit achieve that goal. If you are unsure or are not equipped with the necessary tools, we recommend that you take your unit to a Servicing Dealer for maintenance. To help you decide whether you want to DO-IT-YOURSELF or have the Dealer do it, each maintenance task has been graded. If the task is not listed, see your Dealer for repairs.

NOTICE

The use of emission control components other than those specifically designed for this unit is a violation of federal law.

Skill Levels

Level 1 = Easy to do. Common tools may be required.

Level 2 = Moderate difficulty. Some specialized tools may be required.

Level 3 = See your dealer.

Click [HERE](#) or go to <http://www.echo-usa.com/products/maintenance-kit>

or

[HERE](http://www.shindaiwa-usa.com/you-can.aspx) <http://www.shindaiwa-usa.com/you-can.aspx>

For information about maintenance kits.

Maintenance Intervals

Component	Maintenance Procedure	Skill Level	Interval
Drive Shaft	Apply lithium based grease.	1	Every 25 hours of use.
Gear Housing			Every 15 - 25 hours of use.
Blades	Lubrication	2	As needed.
	Sharpen		
	Adjust		
Screws/Nuts/Bolts	Inspect/Tighten/Replace	1	Before each use.

IMPORTANT - Time intervals shown are maximum. Actual use and your experience will determine the frequency of required maintenance.

Lubrication

Blades

Level 1.

Parts Required: 20W Engine Oil (blade lubrication), 50-50 mixture of kerosene and 20W oil (blade cleaning).

! WARNING

Hedge Trimmer blades are very sharp. Touching them may lead to severe personal injury. Avoid touching blades whenever possible, and always wear gloves to protect hands.

1. Brush loose debris from blade and coat both sides of blade with the 50-50 cleaning mixture.
2. Allow cleaning mixture to soften the remaining gummy residue then wipe it from the blade.
3. Apply clean oil to the entire length of the blade. Be certain the blade bolts are lubricated.
4. Wipe excess oil from the blade before putting the unit back in service.

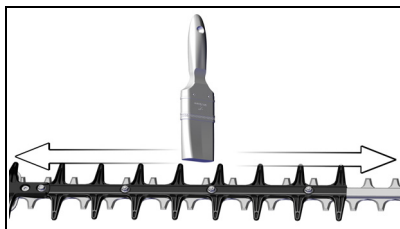

Gear Case

Level 1.

Parts Required: A grease gun with lithium based grease.

1. Clean dirt from the grease fitting (A).
2. Carefully pump grease into fitting (A). DO NOT force grease. Too much pressure will force grease past seals and cause damage. Apply 1 - 2 pumps of grease every 15 - 25 hours of operation.
3. Wipe excess grease from around grease fitting.

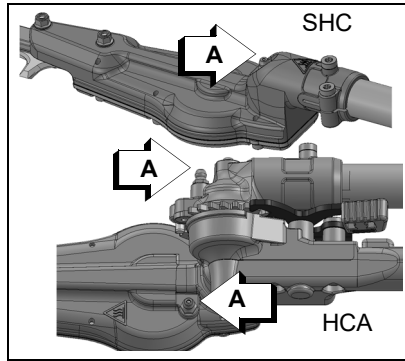

Drive Shaft Assembly

Level 1.

Parts Required: Lithium based grease.

! WARNING

Hedge Trimmer blades are very sharp. Touching them may lead to severe personal injury. Avoid touching blades whenever possible, and always wear gloves to protect hands.

1. Remove gear housing locating screw (A) and loosen clamping screw (B). Remove the gear housing assembly from the drive shaft housing.

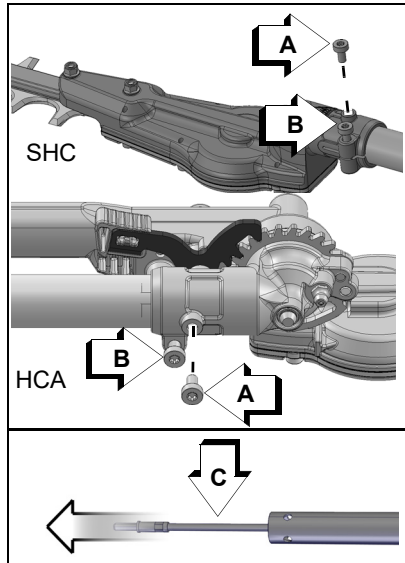

2. Pull the drive shaft (C) from the housing, wipe clean, then apply 15 ml (0.5 oz.) of grease.

3. Slide the drive shaft back in the drive housing being careful not to get dirt on the flex shaft.
4. Install the gear housing assembly.

Blades

! WARNING

Hedge trimmer blades are very sharp, touching them may lead to severe personal injury. Use long hex wrenches and sockets with extensions when tightening blade screws and blade lock nuts to keep hands at a safe distance from sharp blades.

NOTICE

Blades should only be removed and reinstalled by an authorized servicing dealer, otherwise premature wear or internal damage may occur.

Sharpening

Level 2.

NOTICE

If a power grinder is used DO NOT allow blade to over heat.

1. Move stop switch to STOP position.
2. Disconnect spark plug wire.
3. Remove blade guard.
4. Slide blades to allow file clearance using slots (A) on bottom of blade. Do not pry against cutting edges.
5. File each edge carefully. Follow the original shape of the blade.
6. Install blade guard.

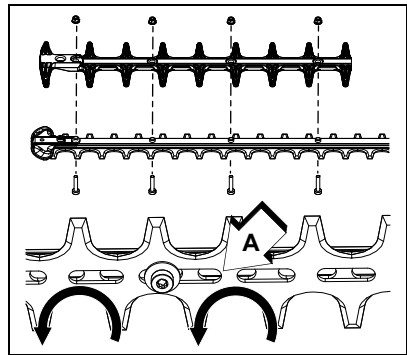

NOTICE

Use new lock nuts each time blade guard is installed. See dealer for correct nuts.

7. Lubricate blades (see "Lubrication").
8. Connect spark plug wire.

Adjustment

Level 2.

NOTICE

Locking ability of hedge trimmer blade lock nuts will diminish each time they are removed. Replace if turning resistance is not felt when installing lock nuts.

1. Tighten blade screws securely.
2. Hold blade screws (A) to prevent turning, and tighten lock nuts (B).

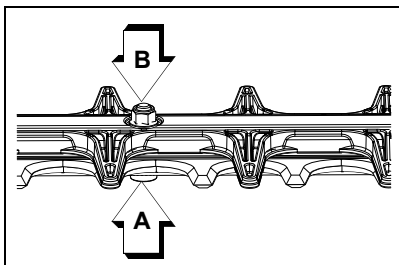

STORAGE

NOTICE

Always install blade cover when transporting or storing unit.

1. Clean and lubricate cutting blades and gear case.
2. Sharpen cutting blades as required.
3. Apply a light coating of clean 20W engine oil along entire length of blades and on blade bolts.
4. Install blade cover onto hedge clipper cutting blades.
5. Store hedge clipper attachment in a dry, dust free place out of the reach of children, using supplied storage hook.

Storage Hook Installation

1. Insert small end of hook into locating hole on attachment shaft.
2. Slide plastic cap onto end of attachment shaft.

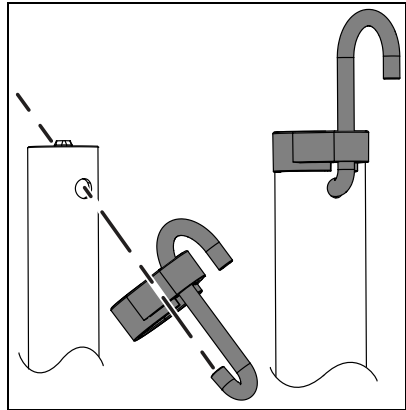

SPECIFICATIONS

MODEL	99944200640
Length	962 mm (37.9 in.)
Width	80 mm (3.1 in.)
Weight	1.65 kg (3.63 lb.)
Gear Case	4.6:1
Cutter	Double Reciprocating Blade - Double Edge
Blade Length	557 mm (21.9 in.)
Pitch	35 mm (1.4 in.)
Maximum Cut	
Soft Materials	25.4 mm (1 in.) diameter
Woody Materials	13 mm (0.5 in.) diameter

PRODUCT REGISTRATION

Thank you for choosing ECHO Power Equipment

Please go to <http://www.echo-usa.com/Warranty/Register-Your-ECHO> to register your new product on-line. It's **FAST** and **EASY!** NOTE: your information will never be sold or misused by ECHO, Incorporated. Registering your purchase enables us to contact you in the unlikely event of a service update or product recall, and verifies your ownership for warranty consideration.

If you do not have access to the Internet, you can complete the form below and mail to:

***ECHO Incorporated, Product Registration, PO Box 1139,
Lake Zurich, IL 60047.***



PRODUCT REGISTRATION CARD : TARJETA DE REGISTRO : CARTE D'ENREGISTREMENT DU PRODUIT

ONLINE OPTION: Register online and save a stamp! You will be alerted of product updates and/or be sent new ECHO product information and special offers. Simply go to: www.echo-usa.com

OPCIÓN POR INTERNET: Regístrese en la página web y ahorre una estampilla. Le alertarán sobre actualizaciones del producto y/o se le enviarán información y ofertas especiales de ECHO. Simplemente visite: www.echo-usa.com

OPTION EN LIGNE: Enregistrer en ligne et épargner un timbre! Vous serez informé sur les nouveaux produits ECHO et les mises à jour de produit ainsi que les offres spéciales. Simplement visitez le: www.echo-usa.com

Please Print : Por Favor Enscriba Con Letra De Molde : En Lettre Carré S.V.P.

Confidential: Information provided will not be shared or sold

Purchaser's Name : Nombre del Comprador : Nom de l'acheteur	
Address : Dirección : Adresse	
City : Ciudad : Ville	State : Estado : Province
	Zip Code : Código Postal : Code Postal
E-Mail Address : Dirección De Correo Electrónico : Courriel Electronique	
Phone Number : Número De Teléfono : Téléphone	Date of Purchase : Fecha de la Compra : Date de l'achat
Where Purchased : Nombre del Almacén donde fue Comprado : Lieu d'achat	
Model Number : Numero del Modelo : No. de modèle	
Serial Number : Numero de Serie : No. de série	

Primary use of tool: Professional Homeowner Rental Equip.
 Uso primario de la herramienta: Profesional Dueño de casa Alquiler
 Usage principal: Professionnel Residential Location
 Do you wish to receive periodic ECHO product information and special offers by e-mail? Yes No

¿Desea usted recibir información periódica y ofertas especiales por correo electrónico sobre el producto ECHO? Yes No

Souhaitez-vous recevoir périodiquement de l'information sur les produits ECHO et les offres spéciales par courrier électronique ? Oui Non

Did you visit the ECHO website before purchasing your product?

Yes No

Visité usted la página web ECHO antes de comprar su producto?

Si No

Avez-vous visité le site d'ECHO avant de procurer votre produit?

Oui Non

What factor(s) most influenced your purchase?

- Performance Price Dealer
 Reliability Prior Experience Quality
 Friend/Family Brand Warranty

- ¿Que factor(es) influenció más en su compra?
 Funcionamiento Precio Distribuidor
 Confiabilidad Experiencia Anterior Calidad
 Amigo/Familia Marca Garantía

What factor (factors) vous a influencé le plus?

- Performance Prix Marchand
 Fiabilité Expérience Qualité
 Ami/Famille Marque Garantie

Registering your purchase enables us to contact you in the unlikely event of a service update or product recall and verifies your purchase. We will never give your information to anyone else without your permission. We will contact you if you do not respond to our service or recall notices within the time frame provided. Please allow 4-6 weeks for processing. Thank you for your purchase!
 L'enregistrement de votre achat nous permettra de vous contacter dans le cas improbable de modifications des instructions d'entretien ou de rappel du produit et vérifier que vous êtes le propriétaire en cas de vol ou de perte.

ECHO INC., 400 Oakwood Rd., Lake Zurich, IL 60047
 1.800.432.ECHO WWW.ECHO-USA.COM

X7572270206 02-2012



NOTES

NOTES

T96900001001 - T96900999999



ECHO INCORPORATED

400 Oakwood Road
Lake Zurich, IL 60047

www.echo-usa.com