



# Operator's Manual 99944200540 Trimmer Attachment

FOR MODELS: SRM-2100SB, 2400SB, 210SB, 211SB, 225SB, 260SB, 261SB, PAS-2100, 2400, 2601, 210, 211, 225, 225VP, 225VPB, 225SB, 230, 231, 260, 261, 265, 266, 280, 2620

## WARNING

*The engine exhaust from this product contains chemicals known to the State of California to cause cancer, birth defects, or other reproductive harm.*

## WARNING



*Read and understand all provided literature before use. Failure to do so could result in serious injury.*

---

**TABLE OF CONTENTS**

---

Table of Contents.....	2
Introduction .....	3
Servicing Information .....	3
Parts/Serial Number.....	3
Service .....	4
ECHO Consumer Product Support.....	4
Product Registration .....	4
Additional Literature .....	4
Safety.....	4
Manual Safety Symbols and Important Information.....	4
International Symbols .....	5
Personal Condition and Safety Equipment.....	7
Equipment.....	12
Description .....	13
Contents.....	14
Assembly.....	14
Power Head Shaft to Lower Shaft Assembly .....	14
Operation .....	15
Operation With Blades.....	15
Blade Selection .....	17
Applications .....	18
Operating Techniques - Nylon Line Head:.....	18
Operating Techniques - metal or plastic blade .....	19
Reaction Forces.....	20
Blade Cutting Problems .....	22
Maintenance .....	22
Skill Levels.....	23
Maintenance Intervals.....	23
Lubrication .....	24
Nylon Line Replacement.....	25
Storage .....	27
Storage Hook Installation.....	27
Specifications.....	27
Product Registration.....	28
Notes .....	30

# INTRODUCTION

Specifications, descriptions and illustrative material in this literature are as accurate as known at the time of publication, but are subject to change without notice. Illustrations may include optional equipment and accessories, and may not include all standard equipment.



Read and understand all provided literature. Literature contains specifications and information for safety, operation, maintenance, storage, and assembly specific to this product. Scan QR codes for more information.



For additional literature, including safety manuals where applicable, or questions regarding terms used in this manual, visit:

<https://www.echo-usa.com/manuals>

OR



<https://www.shindaiwa-usa.com/manuals>

# SERVICING INFORMATION

## Parts/Serial Number

Genuine ECHO Parts and Assemblies for your ECHO products are available only from an Authorized ECHO Dealer. When you do need to buy parts always have the Model Number and Serial Number of the unit with you. For future reference write them in the space provided below.

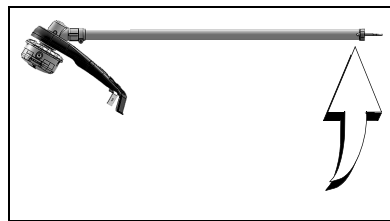

Model No. \_\_\_\_\_ Serial No. \_\_\_\_\_

## Service

Service of this product during the warranty period must be performed by an Authorized ECHO Service Dealer. For the name and address of the Authorized ECHO Service Dealer nearest you, ask your retailer or call: 1-800-432-ECHO (3246). Dealer information is also available on our Web Site [www.echo-usa.com](http://www.echo-usa.com). When presenting your unit for Warranty service/repairs, proof of purchase is required.

## ECHO Consumer Product Support

If you require assistance or have questions concerning the application, operation, or maintenance of this product, call the ECHO Consumer Product Support Department at 1-800-432-ECHO (3246) from 8:00 am to 5:00 pm (Central Standard Time) Monday through Friday. Before calling, please know the model and serial number of your unit.

## Product Registration

Register your ECHO equipment on-line at [www.echo-usa.com](http://www.echo-usa.com) or by filling out the product registration sheet included in this manual. Registering your product confirms warranty coverage and provides a direct link to ECHO if we find it necessary to contact you.

## Additional Literature

In addition to finding information online, information is available from your Authorized ECHO Service Dealer, or by contacting ECHO Inc., 400 Oakwood Road, Lake Zurich, IL 60047 1-800-432-ECHO (3246).

## SAFETY

---

### Manual Safety Symbols and Important Information

Throughout this manual and on the product itself, you will find safety alerts and helpful, informational messages preceded by symbols or key words. The following is an explanation of those symbols and key words and what they mean to you.

### **DANGER**

***The safety alert symbol accompanied by the word “DANGER” calls attention to an act or condition which WILL lead to serious personal injury or death if not avoided.***

**! WARNING**

*The safety alert symbol accompanied by the word “WARNING” calls attention to an act or condition which CAN lead to serious personal injury or death if not avoided.*

**! CAUTION**

*The safety alert symbol accompanied by the word “CAUTION” calls attention to an act or condition which might lead to minor or moderate personal injury if not avoided.*

**NOTICE**

*The enclosed message provides information necessary for the protection of the unit.*

Note: This enclosed message provides tips for use, care and maintenance of the unit.















**CIRCLE AND SLASH SYMBOL**

This symbol means the specific action shown is prohibited. Ignoring these prohibitions can result in serious or fatal injury.

**International Symbols**

Symbol	Description	Symbol	Description
	Warning, see Operator's Manual		Safety / Alert
	Wear eye, ear and head protection		Finger severing
	Wear hand and foot protection		Rotating cutting attachment
	Wear face shield		Wear slip resistant footwear

Symbol	Description	Symbol	Description
	Keep feet away from blade		Do not operate closer than 15 m (50 ft.) from electrical hazards. Keep bystanders at least 15 m (50 ft.) away
	DO NOT USE BLADES - line head only	 	Beware of thrown objects
	Plan retreat path from falling objects.	 	Hot surface
	DO NOT USE LINE HEAD - blades only		
			Keep bystanders and helpers away 15 m (50 ft.).  Beware thrown objects. Wear eye protection.
			Keep bystanders and helpers away 15 m (50 ft.).
			Keep bystanders and helpers away 15 m (50 ft.)

**Personal Condition and Safety Equipment**

** WARNING**

*Cancer and Reproductive Harm  
www.P65Warnings.ca.gov*

** WARNING**



*The muffler or catalytic muffler and surrounding cover may become extremely hot. Always keep clear of exhaust and muffler area, otherwise serious personal injury might occur.*

** WARNING**

*Users of this product risk injury to themselves and others if the unit is used improperly and/or safety precautions are not followed. Proper clothing and safety gear must be worn when operating unit.*

**Physical Condition**

Your judgment and physical dexterity may not be good:

- If you are tired or sick
- If you are taking medication
- If you have taken alcohol or drugs

Operate unit only if you are physically and mentally well.

**Eye Protection**

** WARNING**

- ◆ Eye protection that meets ANSI Z87.1 or CE requirements must be worn whenever you operate the unit.
- ◆ For additional safety, a full-face shield can be worn over safety glasses or goggles to provide protection from sharp branches or flying debris.

## **Hand Protection**

Wear sturdy, no-slip, rubber work gloves to improve your grip on the handles. Gloves also provide protection against cuts and scratches, cold environments, and reduce the transmission of machine vibration to your hands.

## **Hearing/Ear Protection**

ECHO recommends wearing personal protective equipment whenever unit is used.

## **Breathing Protection**

Operators who are sensitive to dust or other common airborne allergens may need to wear a dust mask to prevent inhaling these materials while operating unit. Dust masks can provide protection against dust, plant debris, and other plant matter such as pollen. Make sure the mask does not impair your vision, and replace the mask as needed to prevent air restrictions.

## **Proper Clothing**

Wear snug-fitting, durable clothing:

- Pants should have long legs, shirts should have long sleeves.
- DO NOT WEAR SHORTS.
- DO NOT WEAR TIES, SCARVES, JEWELRY, or clothing with loose or hanging items that could become entangled in moving parts or surrounding growth.
- Keep clothing buttoned or zipped, and keep shirt tails tucked in.
- Wear sturdy work shoes with nonskid rubber soles.
- DO NOT WEAR OPEN TOED SHOES.
- DO NOT OPERATE UNIT WITH BARE FEET.

Keep long hair away from engine and air intake. Retain hair with cap or net.

Heavy protective clothing can increase operator fatigue, which may lead to heat stroke. Schedule heavy work for early morning or late afternoon hours when temperatures are cooler.



 **WARNING**

***The components of this machine generate an electromagnetic field during operation, which can interfere with some pacemakers. To reduce the risk of serious or fatal injury, persons with pacemakers should consult with their physician and the pacemaker manufacturer before operating this machine. In the absence of such information, ECHO does not recommend the use of this machine by anyone who has a pacemaker.***

**Extended Operation / Extreme Conditions** **CAUTION**

***Prolonged exposure to cold and/or vibration can result in injury. Read and follow all safety and operation instructions to minimize risk of injury. Failure to follow instructions can result in painful wrist/hand/arm injuries.***

It is believed that a condition called Raynaud's Phenomenon, which affects the fingers of certain individuals, may be brought about by exposure to vibration and cold. Exposure to vibration and cold may cause tingling and burning sensations, followed by loss of color and numbness in the fingers. The following precautions are strongly recommended, because the minimum exposure, which might trigger the ailment, is unknown.

- Keep your body warm, especially the head, neck, feet, ankles, hands, and wrists.
- Maintain good blood circulation by performing vigorous arm exercises during frequent work breaks, and also by not smoking.
- Limit the hours of operation. Try to fill each day with jobs where operating the unit or other hand-held power equipment is not required.
- If you experience discomfort, redness, and swelling of the fingers followed by whitening and loss of feeling, consult your physician before further exposing yourself to cold and vibration.

## Repetitive Stress Injuries (RSI)

It is believed that overusing the muscles and tendons of the fingers, hands, arms, and shoulders may cause soreness, swelling, numbness, weakness, and extreme pain in those areas. Certain repetitive hand activities may put you at a high risk for developing a Repetitive Stress Injury (RSI). An extreme RSI condition is Carpal Tunnel Syndrome (CTS), which could occur when your wrist swells and squeezes a vital nerve that runs through the area. Some believe that prolonged exposure to vibration may contribute to CTS. CTS can cause severe pain for months or even years.

To reduce the risk of RSI/CTS, do the following:

- Avoid using your wrist in a bent, extended, or twisted position. Instead try to maintain a straight wrist position. Also, when grasping, use your whole hand, not just the thumb and index finger.
  - Take periodic breaks to minimize repetition and rest your hands.
  - Reduce the speed and force with which you do the repetitive movement.
- 
- Do exercises to strengthen the hand and arm muscles.
  - Immediately stop using all power equipment and consult a doctor if you feel tingling, numbness, or pain in the fingers, hands, wrists, or arms. The sooner RSI/CTS is diagnosed, the more likely permanent nerve and muscle damage can be prevented.

## DANGER

***All over head electrical conductors and communications wires can have electricity flow with high voltages. This unit is not insulated against electrical current. Never touch wires directly or indirectly, otherwise serious injury or death can result.***

 **DANGER**

***Do not operate this product indoors or in inadequately ventilated areas. Engine exhaust contains poisonous emissions and can cause serious injury or death.***

**Read Manuals**

- Provide all users of this equipment with literature for instructions on safe operation.

**Clear The Work Area**

- Always clear the work area of foreign objects such as rocks, broken glass, nails, wire, or string, and check for any hidden hazards. Spectators and fellow workers must be warned, and children and animals prevented from coming nearer than 50 ft. (15 m) while the unit is in use.
- Outside the 15 m (50 ft) zone, there is still a risk of injury from thrown objects.
- Bystanders should be encouraged to wear eye protection.
- If you are approached, stop the engine and cutting attachment.
- When a bladed unit is used, there is the added risk of injury to bystanders being struck with the moving blade in the event of a blade thrust or other unexpected reaction of the blade.

**Keep A Firm Grip**

- Always hold throttle handle and support handle with thumbs and fingers tightly encircling the handles.

**Keep A Solid Stance**

- Maintain footing and balance at all times. Do not stand on slippery, uneven or unstable surfaces. Do not work in odd positions or on ladders. Do not over reach.
- Keep cutting attachment below waist.
- Keep all body parts away from rotating cutting attachment

**Avoid Hot Surfaces**

- Keep exhaust area clear of flammable debris. Avoid contact during and immediately after operation.



## Equipment

### **WARNING**

*Use this attachment with ECHO approved models only. Serious injury may result from the use of this attachment combined with a non approved ECHO product.*

- ◆ Check unit for loose/missing nuts, bolts, and screws. Tighten and/or replace as needed.
- ◆ Inspect shield for damage and ensure that the cut-off knife is securely in place. Replace if either is damaged or missing.
- ◆ Check that the cutting attachment is firmly attached and in safe operating condition.

Note: ECHO, INC. will not be responsible for the failure of cutting devices, attachments or accessories which have not been tested and approved by ECHO.

### **WARNING**

*Moving parts can amputate fingers or cause severe injuries. Keep hands, clothing and loose objects away from all openings.*

- ◆ **ALWAYS** stop engine, disconnect spark plug, and make sure all moving parts have come to a complete stop before removing obstructions, clearing debris, or servicing unit.
- ◆ **DO NOT** start or operate unit unless all guards and protective covers are properly assembled to unit.
- ◆ **NEVER** reach into any opening while the engine is running. Moving parts may not be visible through openings.

# DESCRIPTION

Locate the safety decal(s) on your unit. Make sure the decal(s) is legible and that you understand and follow the instructions on it. If a decal cannot be read, a new one can be ordered from your ECHO dealer. Safety label is for example only. Your label may appear slightly different.

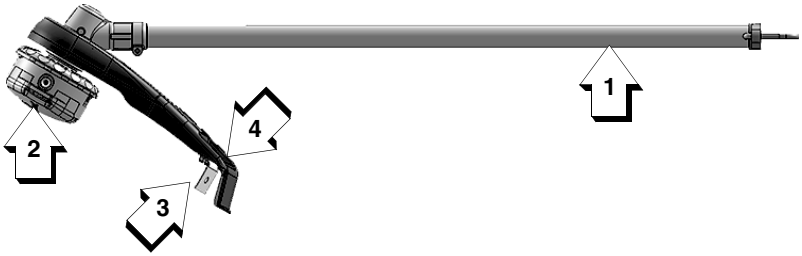

	<p><b>ESP PELIGRO</b></p> <p>Este aparato puede ser peligroso y producir lesiones personales graves si no se usa en forma adecuada. Preste atención a los requisitos de los operadores, usuarios y los espectadores antes que comenzar el trabajo. Consulte al Operador y los Manuales del Proprietario que le entregan con el equipo.</p> <p>Die apparat kann gefährlich sein und schwere Verletzungen verursachen, wenn er nicht ordnungsgemäß verwendet wird. Beachten Sie die Anforderungen der Bediener, Benutzer und Zuschauer, bevor Sie mit der Arbeit beginnen. Konsultieren Sie die Bedienungsanleitung und die Handbücher des Herstellers.</p> <p> Cet appareil peut être dangereux et causer des blessures graves si est mal employé. Pour réduire les risques de blessures à l'opérateur, utilisateur et aux spectateurs, lire et comprendre les manuels de l'opérateur et du fabricant avant d'utiliser l'équipement.</p> <p>Obatung jevarno uporabljati. Preberite si navodila za uporabo in ročnice proizvajalca. Preden začnete uporabljati, preberite navodila za uporabo, uporabniški priročnik in ročnice proizvajalca. Preden začnete uporabljati, preberite navodila za uporabo, uporabniški priročnik in ročnice proizvajalca.</p>	<p><b>FR DANGER</b></p> <p>Cet appareil peut être dangereux et causer des blessures graves si est mal employé. Pour réduire les risques de blessures à l'opérateur, utilisateur et aux spectateurs, lire et comprendre les manuels de l'opérateur et du fabricant avant d'utiliser l'équipement.</p> <p>Obatung jevarno uporabljati. Preberite si navodila za uporabo in ročnice proizvajalca. Preden začnete uporabljati, preberite navodila za uporabo, uporabniški priročnik in ročnice proizvajalca.</p>	<p><b>EN DANGER</b></p> <ul style="list-style-type: none"> <li>This unit can be dangerous and cause serious injury if improperly used. To reduce injury risk to operators, helpers and bystanders, read and understand the Operator and Safety Manuals.</li> <li>Controls may be thrown or received as they operate. Operators, helpers and bystanders read user eye protection and ear protection.</li> <li>Maximum 50 feet (15 meters) CHANGE CHAIN rubras tamponing the operator. Only the company, trained in proper protective clothing, should be within the DANGER ZONE.</li> <li>Always wear hearing protection, gloves and sturdy work boots when operating unit.</li> </ul>	<p><b>CAUTION</b></p> <ul style="list-style-type: none"> <li>Blowbacking attachment does not stop immediately after stopping. Driving into the blade and back clear of backblowing attachment unless engine is shut off and cooling completely is the only way.</li> <li>Do not remove shields, modify the unit or install accessories or parts not approved by ECHO. Approved attachment extension and replacement Operator and Safety Manuals are available from your ECHO dealer or at <a href="http://www.echousa.com">www.echousa.com</a> or by contacting ECHO Inc., 400 Oswood Road, Lake Zurich, IL 60047 (800-479-1556).</li> </ul>	<p><b>GT (CURVED SHAFT) UNITS</b> DO NOT INSTALL METAL BLADES ON GT (CURVED SHAFT) MODELS.</p> <p><b>SRM (STRAIGHT SHAFT) UNITS</b> ONLY use ECHO approved blades on SRM (straight shaft) units equipped with proper blade rings, handle, harness and mounting hardware.</p> <p>Beware of KICKOUT (back thrust) when using blades. Special precautions are necessary for SRM operation; refer to the Operator and Safety Manuals.</p> <p>INSPECT BLADES BEFORE USE. DO NOT USE DAMAGED, CRACKED, BENT, DULL, OR IMPROPERLY SHARPENED BLADES.</p> <p>1008-00000</p>
--	---	--	---	--	--

### Shaft Label

1. DRIVE SHAFT ASSEMBLY
2. NYLON CUTTING ATTACHMENT
3. CUT-OFF KNIFE
4. DEBRIS SHIELD with CUT-OFF KNIFE



## CONTENTS

The ECHO product you purchased has been factory pre-assembled for your convenience.

After opening the carton, check for damage. Immediately notify your retailer or ECHO Dealer of damaged or missing parts. Use the contents list to check for missing parts.

- 1 Trimmer Attachment
- 1 Operator's Manual
- 1 Warranty Sheet
- 1 Storage Hook Assembly

## ASSEMBLY

### Power Head Shaft to Lower Shaft Assembly

#### **WARNING**

***Do not perform maintenance or assembly procedures with engine running.***

Parts Required: PAS or SRM-SB Power Head Shaft and Coupling

1. Set Power Head/Shaft Assembly on a level surface.
2. Pull locator pin (A) out, and turn counterclockwise one-quarter turn to lock-out position.
3. Remove storage hook and cap from attachment drive shaft.

Note: Your coupler may appear different than coupler shown. Earlier model power heads may have shorter couplings.

4. Carefully fit attachment drive shaft assembly into coupler (B). Rotate the shaft (C) to make sure the inner lower drive shaft engages the square upper drive shaft socket.

Note: Lower bearing housing and head assembly must be in line with the engine.

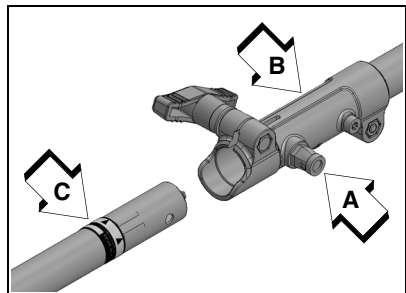

Note: Some models have an assembly line decal to assist in assembly.

- 5. Rotate locator pin (A) one-quarter turn clockwise to engage lower shaft hole. Make sure locator pin is fully engaged by rotating the lower drive shaft. Locator pin should snap flush in coupler. Full engagement will prevent further shaft rotation.
- 6. Secure lower shaft assembly to coupler by tightening clamping knob (D).

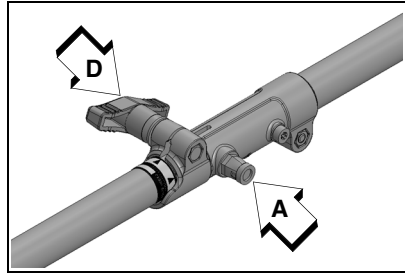

## OPERATION

### WARNING

***Moving parts can amputate fingers or cause severe injuries. Keep hands, clothing and loose objects away from all openings. Always stop engine, disconnect spark plug, and make sure all moving parts have come to a complete stop before removing obstructions, clearing debris, or servicing unit.***

Note: Refer to your PAS power source Operator's Manuals for correct engine fueling, starting and stopping instructions.

### Operation With Blades

### WARNING

***Metal blades are very sharp and can cause severe injuries, even if engine is off and blades are not moving. Avoid contact with blades. Wear gloves to protect hands.***

### WARNING

***Blade use demands specific brush cutter configuration. Operation without specified shield, barrier bar or U-handle, and harness can result in serious personal injury. Follow installation instructions.***

Pro Maxi-Cut Grass/Weed Blade	Tri-Cut Grass/Weed Blade	Metal Grass / Weed Blade	Metal Brush / Clearing Blades
Support Handle, with or without Barrier Bar	U-Handle or Support Handle with Barrier Bar		U-handle*
Shield with cutoff knife	Shield without cutoff knife		
Harness			
Upper Plate & Flat Washer	Upper/Lower Blade Plates		
Hex Nut			
New Cotter Pin			

\*ANSI standards require brush cutters be equipped with a barrier bar or restrictive harness. U-Handle ensures a higher safety factor.

## **WARNING**

### ***Do Not install blades on GT (Curved Shaft) model trimmers.***

- Use only ECHO approved parts. Failure to use the correct parts can cause the blade to fly off. Seriously injury to the operator and / or bystanders can occur.
- Arbor diameter of upper blade plate must match arbor diameter of blades.
- For barrier bar or u-handle, follow instructions supplied with either blade conversion kit or U-handle kit, and verify blade is secured properly.
- A new cotter pin is required each time a blade is installed.
- Shoulder harnesses may be used on all trimmers and brushcutters to reduce operator fatigue. Brushcutters over 7.5 kg (16.5 lbs.) dry weight (without fuel) and u- handle brushcutters REQUIRE a double shoulder harness.

**Note:** The barrier bar is used to restrict rearward movement of the unit. The barrier bar is not a handle and should not be gripped when using or carrying the unit.



## Blade Selection

### **WARNING**

*The type of blade used **MUST** be matched to the type and size of material cut. An improper or dull blade can cause serious personal injury. Blades **MUST** be sharp. Dull blades increase the chance of kick-out and injury to yourself and bystanders. Never use an edging blade, circular saw blade, or any other type of unapproved blade.*

**3-Tooth Grass/Weed Blades** may be used wherever the nylon line head is used. DO NOT use this blade for heavy weeds or brush.

**8 Tooth Weed/Grass Blade** is designed for grass, garden debris and thick weeds up to 19 mm (0.75 in.) diameter. DO NOT use this blade for brush or heavy woody growth.

**80 Tooth Brush Blade** is designed for cutting brush and woody growth up to 13 mm (0.5 in.) diameter.

**22 Tooth Clearing Blade** is designed for dense thickets and saplings up to 64 mm (2.5 in.) diameter.

### **WARNING**

*A trimmer-brushcutter with a metal blade can cause serious injuries if handled improperly.*

Always use extreme care when carrying or handling the equipment to avoid contact with the cutting edges of the blade. Use the optional blade cover when unit is not in use.

Keep blades in protective packaging until ready to install. Store blades safely after removal to prevent injury from accidental contact.

Use blade protectors to protect blade teeth during unit transportation.

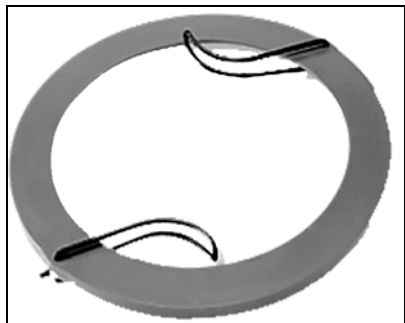

### Use Shoulder/Waist Harness

Use of the shoulder/waist harness is recommended for ALL Trimmer/brushcutter use, not just blade operation. The shoulder/waist harness when used in a trimming operation with nylon line head suspends the trimmer from the operator's shoulder and reduces operator fatigue.

During blade operation, the same fatigue reduction is achieved. Safety to the operator is also enhanced by reducing the possibility of blade contact with the operator's hands and feet by restricting trimmer movement.

Make sure the warning sign on the back of the shoulder harness can be read easily.

Note: In case of Emergency, disconnect the trimmer from the harness.



### Applications

## WARNING

***Do Not install blades on GT (Curved Shaft) or T model trimmers.***

### Operating Techniques - Nylon Line Head:

Nylon line heads may be used for trimming, scything, edging, and scalping of grass and light weeds.

#### Trimming

Feed the spinning line into the material to be cut. Tilt the line head to one side to direct cutting debris away from you:

- Model SRM/PAS/SB/TX/C/T (Straight shaft, counter-clockwise line head rotation) - Tilt the cutting head down on the right side (muffler side) while cutting to direct cutting debris away from operator. Feed the line gradually into the material you wish to cut, avoiding contact with fences or other barriers.
- GT models: Tilt cutting head to the left while cutting to direct debris away from the operator.

## Scything

Scything - Swing the cutting head in a level arc, gradually feeding the line into the material being cut. Move forward with each arc to cut a swath. Width of cutting swath depends on arc. Use a larger arc for a wider swath, or a smaller arc for a narrow swath. Keep line head tilted to direct cutting debris forward or away from you.

## Edging and Scalping

Both of these are done with the nylon line cutting head tilted at a steep angle. Scalping is removing top growth, leaving the earth bare. Edging is trimming the grass back where it has spread over a pavement or driveway. During both edging and scalping, hold the unit at a steep angle in a position where the debris, and any dislodged dirt and stone, will not come back towards you even if it ricochets off the hard surface.

## General

- Debris flows in direction of line head rotation. Change line head position to assure debris flow is directed away from operator.
- Keep cutting line away from wire fences to avoid entanglement.
- Operate trimmer only with cutting head below knee height.

## Operating Techniques - metal or plastic blade

Brush cutter blades may be used to cut and trim a wide variety of materials, refer to the blade selection section for determining the correct blade for the application.

## Scything (3, 8, and 80 tooth weed/grass, and brush blades)

- To cut large sections of field grass and weeds swing the cutting head in a level arc, gradually feeding the blade into the material being cut. Adjust throttle speed according to your work.
- Do not swing the main pipe with arms. Turn hips to swing the blade horizontally from right to left, and cut weeds on the left side of the blade.
- Do not scythe back and forth as the grass may scatter and kickback may occur easily.
- Tilt blade left by 5 to 10 degrees so that cut grasses will push left, making progress easier.
- Move forward with each arc to cut a swath.



- Width of cutting swath depends on arc. Use a larger arc for a wider swath, or a smaller arc for a narrow swath. Suggested cutting width is about 1.5 m (4.9 ft).
- When scything large brush up to 0.5" diameter from right to left, avoid cutting with highlighted section.

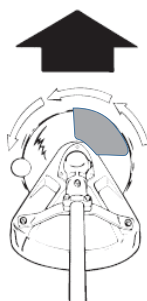

## Reaction Forces

### WARNING

- ◆ The cutting attachment will continue to rotate even after the throttle is released, maintain control of the unit until it has come to a complete stop.
- ◆ Blade thrust may occur when the spinning blade contacts an object that it does not immediately cut. Following proper cutting techniques will prevent blade thrust.
- ◆ Blade thrust can be violent enough to cause the unit and/or operator to be propelled in any direction, and possibly lose control of the unit.
- ◆ Blade thrust can occur without warning if the blade snags, stalls or binds.
- ◆ Blade thrust is more likely to occur in areas where it is difficult to see the material being cut.

## Push or Pull - Kickback or Kickout

During normal use, operating a brushcutter with a circular metal blade can produce sudden strong reaction forces that are difficult to control. Strong reaction forces can cause a loss of balance or loss of control of the equipment, resulting in serious injury to operator and bystanders.

Understanding what causes these reactive forces may help you to avoid them, and can help you to maintain control of the equipment if you experience a sudden reaction during cutting. Reactive forces occur when the force being applied by the cutting teeth of a blade meet resistance, and some of the cutting force is directed back toward the equipment. The greater the cutting force or the amount of resistance, the greater the reactive force.

### Push and Pull Forces

Push and pull forces are reactive forces that push the equipment directly toward the operator, or that pull the equipment directly away from the operator. These forces are the result of cutting on the sides of the blade. The direction of the force depends on the side of the blade being used, and the direction of blade rotation at the point of contact. The reactive force is in the opposite direction of blade rotation at the contact point, regardless of where the contact is being made. These types of reactive forces are also called “Blade Thrust.”



As shown in the illustration, a blade turning counterclockwise will cause the equipment to pull away from the operator if the point of cutting resistance is on the left side of the blade. If the point of cutting resistance is on the right side of the blade, the equipment will push back toward the operator. In both examples, the reactive force is in the opposite direction of blade rotation at the contact point where resistance occurs.

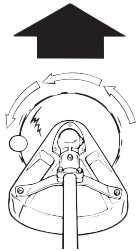

### Kickout

Kickout is also a reactive force caused by resistance to cutting, but the direction of blade thrust is lateral (to the left or right of the blade), instead of forward or back toward the operator. In most cases, Push, Pull, and Kickout can be reduced or eliminated by:

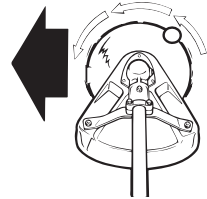

- Using the correct blade for the cutting job
- Using properly sharpened blades
- Applying consistent, even force to the blade during the cut
- Avoiding obstacles and ground hazards
- Using extra care when cutting harder materials such as extremely dry brush, saplings, and small trees
- Cutting from a stable, secure position

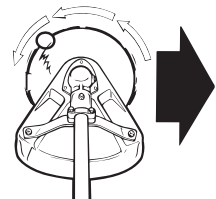

**Blade Cutting Problems**

Binding - Blades may bind in the cut if dull or forced. Binding can damage blade, and result in blade breakage or injury from fragments and flying debris. If a blade binds in a cut, don't try to get it out by applying "up and down" force to pry the cut open. Applying prying force to the blade can bend the blade, and result in blade failure and injury.



To free a blade that is bound in the cut, stop the engine, and support the trimmer or brushcutter to keep stress off the blade. Push the tree away from the entry point of the cut to open the cut, and pull the blade directly away from the cut in a straight-line motion. Use caution when releasing the tree to avoid being struck by spring-back or falling.

Inspect the blade for damage before proceeding. Sharpen teeth if dull, or replace blade if cracked, bent, missing teeth, or otherwise damaged.

To prevent binding:

- Keep blades sharp
- Avoid excessive pressure during cuts
- Don't exceed cutting capacity of blade
- Don't use blades with damaged or missing cutting teeth
- Don't rock blades in cut

**MAINTENANCE**

**⚠ WARNING**

***Moving parts can amputate fingers or cause severe injuries. Keep hands, clothing and loose objects away from all openings. Always stop engine, disconnect spark plug, and make sure all moving parts have come to a complete stop before removing obstructions, clearing debris, or servicing unit. Allow unit to cool before performing service. Wear gloves to protect hands from sharp edges and hot surfaces.***

## **WARNING**

***Operating a poorly maintained unit can result in serious injuries to operator or bystanders. Always follow all maintenance instructions as written, otherwise serious personal injury can result.***

Your unit is designed to provide many hours of trouble free service. Regular scheduled maintenance will help your unit achieve that goal. If you are unsure or are not equipped with the necessary tools, we recommend that you take your unit to a Servicing Dealer for maintenance. To help you decide whether you want to DO-IT-YOURSELF or have the Dealer do it, each maintenance task has been graded. If the task is not listed, see your Dealer for repairs.

## **NOTICE**

*The use of emission control components other than those specifically designed for this unit is a violation of federal law.*

### **Skill Levels**

**Level 1** = Easy to do. Common tools may be required.

**Level 2** = Moderate difficulty. Some specialized tools may be required.

**Level 3** = See your dealer.

Click [HERE](#) or go to <http://www.echo-usa.com/products/maintenance-kit>  
or

[HERE https://www.shindaiwa-usa.com/you-can.aspx](https://www.shindaiwa-usa.com/you-can.aspx)

For information about maintenance kits.

### **Maintenance Intervals**

Component/ System	Maintenance Procedure	Skill Level	Interval
Drive Shaft	Grease <sup>1</sup>	1	Every 25 hours of use
Gear Housing			Every 50 hours of use
Screws/Nuts/Bolts	Inspect/Tighten/ Replace		Before Each Use

**IMPORTANT** - Time intervals shown are maximum. Actual use and your experience will determine the frequency of required maintenance.

**MAINTENANCE PROCEDURE NOTES:**

1 Apply lithium based grease.

**Lubrication**

**Level 1.**

Parts Required: Lithium Based Grease.

**Gear Case**

**NOTICE**

*Gear cases without grease plug (A) do not require lubrication.*

1. Clean all loose debris from gear case.
2. Remove plug (A) and check level of grease.
3. Add grease if necessary. **DO NOT** over-fill.

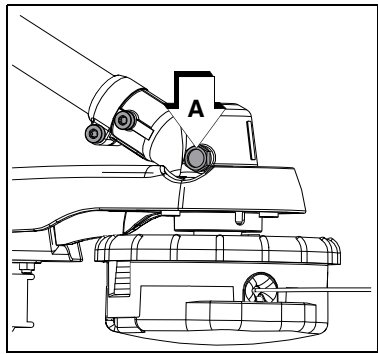

**Drive Shaft (Lower)**

1. Loosen screw (B) and remove locating screw (C). Pull gear case and shield from drive shaft housing.
2. Pull flexible cable (D) from the drive shaft housing, wipe clean and re-coat with 15 ml (0.5 oz.) of grease.

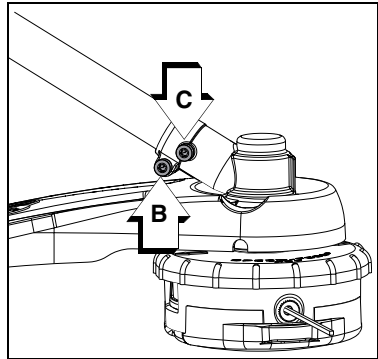



3. Slide the flexible cable (D) back in the drive housing. DO NOT get dirt on the flex cable.
4. Install the gear housing and shield assembly.

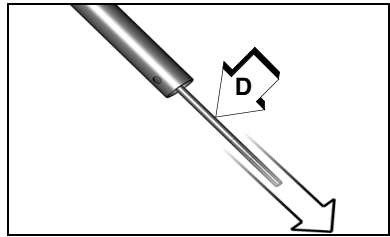

### Nylon Line Replacement

## CAUTION

*Wear gloves or personal injury may result:*

- ◆ *Cutoff knife is sharp.*
- ◆ *Gearcase and surrounding area may be hot.*

## WARNING

*Never use wire or wire-rope that can break off and become a dangerous "projectile". Serious injury can occur.*

1. Cut one piece of line to recommended length.  
2.0 mm (0.080 in.) diameter  
6 m (20 ft.).  
2.4 mm (0.095 in.) diameter  
6 m (20 ft.).
2. Align arrows on top of knob with openings in eyelets.
3. Insert one end of trimmer line into an eyelet, and push line equal distance through trimmer head.

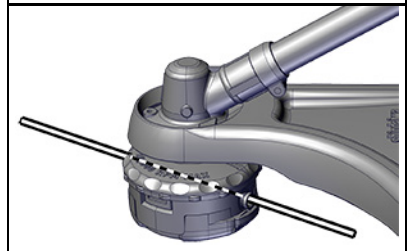
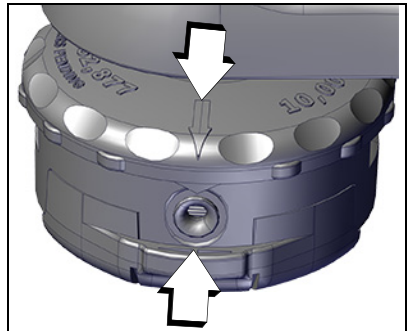

4. Hold trimmer head while turning knob clockwise to wind line onto spool until about 13 cm (5 in.) of each line remains exposed.

**Trimmer head is now fully loaded and ready for operation.**

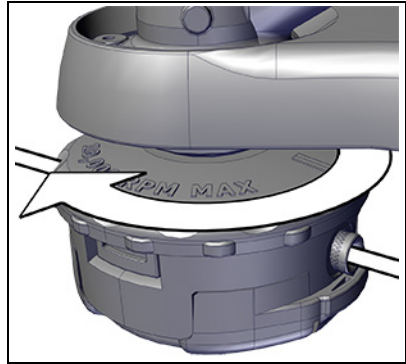

**NOTICE**

*When the wear indicators located at the bottom of the Speed-Feed® head are worn smooth, or if holes appear, replacement of the cover or the entire Speed-Feed® head is required.*



# STORAGE

## Storage Hook Installation

- 1. Insert small end of hook into locating hole on attachment shaft.
- 2. Slide plastic cap onto end of attachment shaft.

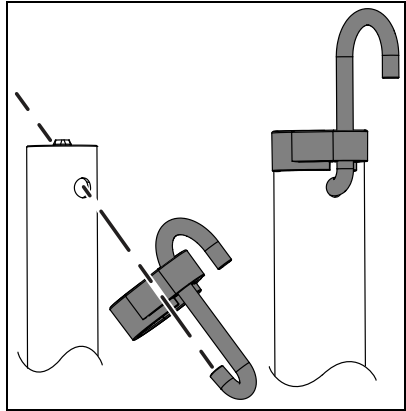

## SPECIFICATIONS

MODEL	99944200540 (Speed-Feed® Trimmer)
Shaft Length	834 mm (32.8 in.)
Attachment Width	177 mm (6.9 in.)
Attachment Height	236 mm (9.29 in.)
Weight (dry) w/line head	1.07 kg (2.3 lb.)
Drive Shaft	6.35 mm (0.25 in.) Flex Shaft
Gear Case Ratio	1.62 : 1
Direction of Rotation	Counter clockwise viewed from the top
Cutter Head	Speed-Feed® Nylon line head
Line Capacity	6 m (20 ft.)

---

**PRODUCT REGISTRATION**

---

**Thank you for choosing ECHO Power Equipment**

Please go to <http://www.echo-usa.com/Warranty/Register-Your-ECHO> to register your new product on-line. It's **FAST** and **EASY!** NOTE: your information will never be sold or misused by ECHO, Incorporated.

Registering your purchase enables us to contact you in the unlikely event of a service update or product recall, and verifies your ownership for warranty consideration.

If you do not have access to the Internet, you can complete the form below and mail to:

***ECHO Incorporated, Product Registration, PO Box 1139, Lake Zurich IL 60047.***







S06400369501/S06400999999



**ECHO INCORPORATED**

400 Oakwood Road  
Lake Zurich, IL 60047

[www.echo-usa.com](http://www.echo-usa.com)