



99944200532

Power Pruner™

Attachment

FOR MODELS: SRM-2100SB, 2400SB, 210SB, 211SB, 225SB, 260SB, 261SB, PAS-2100, 2400, 2601, 210, 211, 225, 225VP, 225VPB, 230, 231, 260, 261, 265, 266, 280, 2620

Operator's Manual

WARNING



Users of this equipment risk injury to themselves and others if the unit is used improperly and/or safety precautions are not followed. ECHO provides an operator's manual and a safety manual. Both must be read and understood for proper and safe operation. Failure to do so could result in serious injury.

Specifications, descriptions and illustrative material in this literature are as accurate as known at the time of publication, but are subject to change without notice. Illustrations may include optional equipment and accessories, and may not include all standard equipment.

TABLE OF CONTENTS

Introduction	3
Servicing Information	3
Parts/Serial Number	3
Service	3
Echo Consumer Product Support	4
Product Registration	4
Additional or Replacement Manuals	4
Safety	4
Manual Safety Symbols and Important Information	4
International Symbols	5
Personal Condition and Safety Equipment	7
Guide Bar and Saw Chain	11
Kickback.....	12
Equipment.....	13
Description	15
Contents.....	16
Assembly.....	16
Power Head Shaft To Lower Shaft Assembly.....	16
Support Handle Removal.....	17
Saw Chain Adjustment.....	18
Operation	19
Lubricating the Guide Bar and Saw Chain.....	19
Note: Very little visible oil on the saw chain will provide sufficient lubrication.	20
Pruning Techniques	20
Maintenance	22
Skill Levels	22
Maintenance Intervals.....	23
Lubrication	23
Guide Bar and Saw Chain Replacement	24
Filing Standard Saw Chain	25
Storage.....	28
Storage Hook Installation.....	28
Specifications.....	28
Notes.....	29
Product Registration.....	30

INTRODUCTION

Welcome to the ECHO family. This ECHO product was designed and manufactured to provide long life and on-the-job dependability. Read and understand this manual and the safety manual. Keep the manuals in a safe place for future reference.

The operators manual contains specifications and information for safety, operation, maintenance, storage and assembly specific to this product. Scan the QR codes throughout the operator's manual for more information.

The safety manual explains possible hazards and the measures you should take to insure safe operation.

SERVICING INFORMATION

Parts/Serial Number

Genuine ECHO Parts and Assemblies for your ECHO products are available only from an Authorized ECHO Dealer. When you do need to buy parts always have the Model Number and Serial Number of the unit with you. For future reference write them in the space provided below.

Model No. _____

Serial No. _____

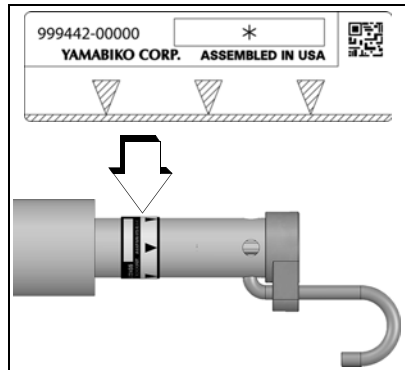

Service

Service of this product during the warranty period must be performed by an Authorized ECHO Service Dealer. For the name and address of the Authorized ECHO Service Dealer nearest you, ask your retailer or call: 1-800-432-ECHO (3246). Dealer information is also available on our Web Site. www.echo-usa.com. When presenting your unit for Warranty service/repairs, proof of purchase is required.

Echo Consumer Product Support

If you require assistance or have questions concerning the application, operation, or maintenance of this product, call the ECHO Consumer Product Support Department at 1-800-673-1558 from 8:00 am to 5:00 pm (Central Standard Time) Monday through Friday. Before calling, please know the model and serial number of your unit.

Product Registration

Register your ECHO equipment on-line at www.echo-usa.com or by filling out the product registration sheet included in this manual. Registering your product confirms warranty coverage and provides a direct link to ECHO if we find it necessary to contact you.

Additional or Replacement Manuals

Replacement Operator or Safety Manuals, and Parts Catalogs, are available from your Authorized ECHO Service Dealer, or at www.echo-usa.com, or by contacting ECHO Inc., 400 Oakwood Road, Lake Zurich, IL 60047 (800-673-1558). Always check www.echo-usa.com for updated information.



Safety Videos are available from your Authorized ECHO Service Dealer. A \$5.00 shipping charge is required for each video.

SAFETY

Manual Safety Symbols and Important Information

Throughout this manual and on the product itself, you will find safety alerts and helpful, informational messages preceded by symbols or key words. The following is an explanation of those symbols and key words and what they mean to you.

DANGER

The safety alert symbol accompanied by the word “DANGER” calls attention to an act or condition which WILL lead to serious personal injury or death if not avoided.

WARNING

The safety alert symbol accompanied by the word “WARNING” calls attention to an act or condition which CAN lead to serious personal injury or death if not avoided.

CAUTION

The safety alert symbol accompanied by the word “CAUTION” calls attention to an act or condition which may lead to minor or moderate personal injury if not avoided.

NOTICE

The enclosed message provides information necessary for the protection of the unit.





Note: This enclosed message provides tips for use, care and maintenance of the unit.





















CIRCLE AND SLASH SYMBOL

This symbol means the specific action shown is prohibited. Ignoring these prohibitions can result in serious or fatal injury.

International Symbols

Symbol	Description	Symbol	Description
	Warning, See Operator's Manual	H	Carburetor Adjustment - High Speed Mixture
	Wear Eye, Ear and Head Protection	T	Carburetor Adjustment - Idle Speed
	Wear Hand and Foot Protection	L	Carburetor Adjustment - Low Speed Mixture
	Safety / Alert		Emergency Stop

Symbol	Description	Symbol	Description
	Hot Surface		Fuel and Oil Mixture
	<p>AVOID KICKOUT Keep Bystanders At Least 15 m (50 ft.) Away</p> <p>Beware Thrown Objects Wear Eye Protection</p>		
	Keep Bystanders and Helpers Away 15 m (50 ft.)		
	DO NOT Allow Flames or Sparks Near Fuel	<p>Ignition</p> 	Ignition ON / OFF
	DO NOT Smoke Near Fuel		Primer Bulb
	Choke Control "RUN" Position (Choke Open)		Choke Control "COLD START" Position (Choke Closed)
	Keep Feet Away From Blade		Rotating Cutting Attachment
	Thrown Objects		Wear Face Shield
	Finger Severing		Wear Slip Resistant Footwear

Symbol	Description	Symbol	Description
	Do not operate closer than 15 m (50 ft.) from electrical hazards. Keep bystanders at least 15 m (50 ft.) away.		DO NOT USE BLADES - Line Head Only
	Plan retreat path from falling objects.		



LOOK BEFORE YOU PUMP!
Ethanol Percentage
0% - 10% 15% - 30% - 50% - 85%
USE E10 OR LESS FUEL
Do not use any fuel containing greater than 10 percent ethanol (E10) in this equipment. It may cause damage or failure and is prohibited by Federal Law.
For Details, see the "Fuel" Section of your Operators Manual

Personal Condition and Safety Equipment

! WARNING

Users of this product risk injury to themselves and others if the unit is used improperly and/or safety precautions are not followed. Proper clothing and safety gear must be worn when operating unit.

Physical Condition

Your judgment and physical dexterity may not be good:

- If you are tired or sick.
- If you are taking medication.

- If you have taken alcohol or drugs.

Operate unit only if you are physically and mentally well.

Eye Protection

WARNING

- ◆ **Eye protection that meets ANSI Z87.1 or CE requirements must be worn whenever you operate the unit.**
- ◆ **For additional safety, a full-face shield may be worn over safety glasses or goggles to provide protection from sharp branches or flying debris.**

Hand Protection

Wear sturdy, no-slip, rubber work gloves to improve your grip on the handles. Gloves also provide protection against cuts and scratches, cold environments, and reduce the transmission of machine vibration to your hands.

Hearing/Ear Protection

ECHO recommends wearing hearing protection whenever unit is used.

Breathing Protection

Operators who are sensitive to dust or other common airborne allergens may need to wear a dust mask to prevent inhaling these materials while operating unit. Dust masks can provide protection against dust, plant debris, and other plant matter such as pollen. Make sure the mask does not impair your vision, and replace the mask as needed to prevent air restrictions.

Proper Clothing

Wear snug-fitting, durable clothing:

- Pants should have long legs, shirts should have long sleeves.
- DO NOT WEAR SHORTS.
- DO NOT WEAR TIES, SCARVES, JEWELRY, or clothing with loose or hanging items that could become entangled in moving parts or surrounding growth.
- Keep clothing buttoned or zipped, and keep shirt tails tucked in.

Wear sturdy work shoes with nonskid rubber soles:

- DO NOT WEAR OPEN TOED SHOES.
- DO NOT OPERATE UNIT BAREFOOTED.

Keep long hair away from engine and air intake. Retain hair with cap or net.

Heavy protective clothing can increase operator fatigue, which may lead to heat stroke. Schedule heavy work for early morning or late afternoon hours when temperatures are cooler.

! WARNING

The components of this machine generate an electromagnetic field during operation, which may interfere with some pacemakers. To reduce the risk of serious or fatal injury, persons with pacemakers should consult with their physician and the pacemaker manufacturer before operating this machine. In the absence of such information, ECHO does not recommend the use of this machine by anyone who has a pacemaker.

Extended Operation / Extreme Conditions

! CAUTION

Prolonged exposure to cold and/or vibration may result in injury. Read and follow all safety and operation instructions to minimize risk of injury. Failure to follow instructions may result in painful wrist/hand/arm injuries.

It is believed that a condition called Raynaud's Phenomenon, which affects the fingers of certain individuals, may be brought about by exposure to vibration and cold. Exposure to vibration and cold may cause tingling and burning sensations, followed by loss of color and numbness in the fingers. The following precautions are strongly recommended, because the minimum exposure, which might trigger the ailment, is unknown.

- Keep your body warm, especially the head, neck, feet, ankles, hands, and wrists.
- Maintain good blood circulation by performing vigorous arm exercises during frequent work breaks, and also by not smoking.
- Limit the hours of operation. Try to fill each day with jobs where operating the unit or other hand-held power equipment is not required.

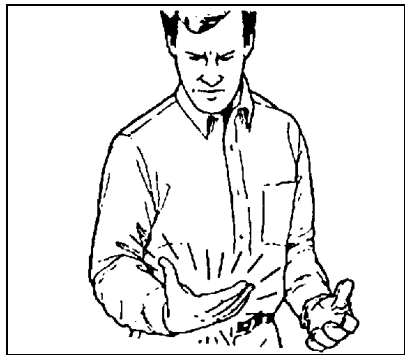

- If you experience discomfort, redness, and swelling of the fingers followed by whitening and loss of feeling, consult your physician before further exposing yourself to cold and vibration.

Repetitive Stress Injuries (RSI)

It is believed that overusing the muscles and tendons of the fingers, hands, arms, and shoulders may cause soreness, swelling, numbness, weakness, and extreme pain in those areas. Certain repetitive hand activities may put you at a high risk for developing a Repetitive Stress Injury (RSI). An extreme RSI condition is Carpal Tunnel Syndrome (CTS), which could occur when your wrist swells and squeezes a vital nerve that runs through the area. Some believe that prolonged exposure to vibration may contribute to CTS. CTS can cause severe pain for months or even years.

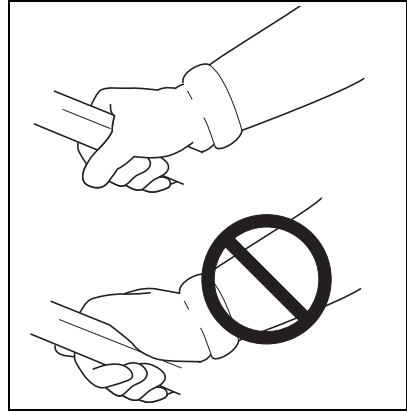

To reduce the risk of RSI/CTS, do the following:

- Avoid using your wrist in a bent, extended, or twisted position. Instead try to maintain a straight wrist position. Also, when grasping, use your whole hand, not just the thumb and index finger.
- Take periodic breaks to minimize repetition and rest your hands.
- Reduce the speed and force with which you do the repetitive movement.
- Do exercises to strengthen the hand and arm muscles.
- Immediately stop using all power equipment and consult a doctor if you feel tingling, numbness, or pain in the fingers, hands, wrists, or arms. The sooner RSI/CTS is diagnosed, the more likely permanent nerve and muscle damage can be prevented.

DANGER

All over head electrical conductors and communications wires can have electricity flow with high voltages. This unit is not insulated against electrical current. Never touch wires directly or indirectly, otherwise serious injury or death may result.

! DANGER

Do not operate this product indoors or in inadequately ventilated areas. Engine exhaust contains poisonous emissions and can cause serious injury or death.

Guide Bar and Saw Chain

! DANGER

- ◆ ***Serious injury may result from the use of non approved guide bar and saw chain combinations. Read and comply with all safety instructions listed in this manual.***
- ◆ ***ECHO, INC. will not be responsible for the failure of cutting devices or accessories which have not been tested and approved by ECHO for use with this unit.***
- Never adjust the guide bar or saw chain when the engine is operating.
- Check that the cutting attachment, guide bar and saw chain is firmly attached and in safe operating condition.
- Only use ECHO approved guide bar and saw chain.
- Do not hit rocks, stones, tree stumps and other foreign objects with the saw chain.
- Do not cut into the ground with the saw chain.
- If saw chain strikes an obstruction, stop engine immediately and inspect saw chain for damage.
- Do not operate with a dull, broken or discolored saw chain.
- Remove all foreign objects from work area.
- Always cover the guide bar and saw chain with guide bar cover during transportation and in storage.

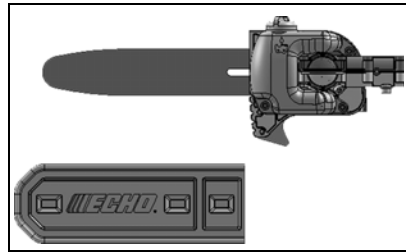

Read the Manuals

- Provide all users of this equipment with the Operator's Manual and Safety Manual for instructions on Safe Operation.

Clear the Work Area

- Spectators and fellow workers must be warned, and children and animals prevented from coming nearer than 15 m (50 ft.) while the unit is in use.

Use Proper Clothing & Equipment

- Always wear head protection with full face shield to help protect against falling branches and debris.

Keep a Firm Grip

- Always hold throttle handle and support handle with thumbs and fingers tightly encircling the handles.

Keep a Solid Stance

- Maintain footing and balance at all times. Do not stand on slippery, uneven or unstable surfaces. Do not work in odd positions or on ladders. Do not over reach.

Avoid Hot Surfaces

- During operation, the drive shaft housing and attachment bearing housing may become very hot, too hot to touch. Avoid contact during and immediately after operation.

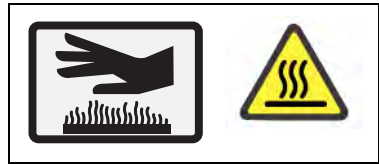

Kickback

WARNING

Kickback can lead to dangerous loss of control of the Power Pruner and result in serious injury to the operator or any one standing close by. Hold the Power Pruner firmly with both hands with thumbs and fingers encircling the front and rear handles. Be aware of the down and outward path the pruner will take after the cut is made.

Kickback may occur when the moving saw chain at the nose or tip of the guide bar touches an object, or when the wood closes in and pinches the saw chain in the cut. In some cases this may cause a lightning-fast reverse action, kicking the guide bar and saw chain up and back or down and back towards the operator. Either of these reactions may cause the operator to lose control of the Power Pruner™ which could result in serious personal injury.

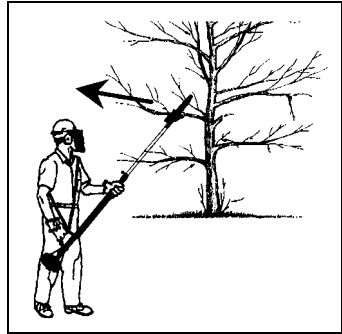

With a basic understanding of kickback, you can reduce or eliminate the element of surprise which contributes to accidents.

Avoid contact of the guide bar tip with any object while the saw chain is moving.

Cut only wood. Avoid striking concrete, metal, wire, or other obstructions which could cause kickback or damage to the saw chain.

If the saw chain does strike a foreign object, immediately stop the engine, inspect and repair the Power Pruner™ if necessary.

Equipment

WARNING

Use this attachment with ECHO approved models only. Serious injury may result from the use of this attachment combined with a non approved ECHO product.

- Check unit for loose/missing nuts, bolts, and screws. Tighten and/or replace as needed.
- Inspect shield for damage and that shield is securely in place. Replace if shield is damaged or missing.
- Check that the cutting attachment is firmly attached and in safe operating condition.

Note: ECHO, INC. will not be responsible for the failure of cutting devices, attachments or accessories which have not been tested and approved by ECHO.

 **WARNING**

Moving parts can amputate fingers or cause severe injuries. Keep hands, clothing and loose objects away from all openings.

- ◆ *ALWAYS stop engine, disconnect spark plug, and make sure all moving parts have come to a complete stop before removing obstructions, clearing debris, or servicing unit.*
- ◆ *DO NOT start or operate unit unless all guards and protective covers are properly assembled to unit.*
- ◆ *NEVER reach into any opening while the engine is running. Moving parts may not be visible through openings.*

DESCRIPTION

Locate the safety decal(s) on your unit. Make sure the decal(s) is legible and that you understand and follow the instructions on it. If a decal cannot be read, a new one can be ordered from your ECHO dealer.

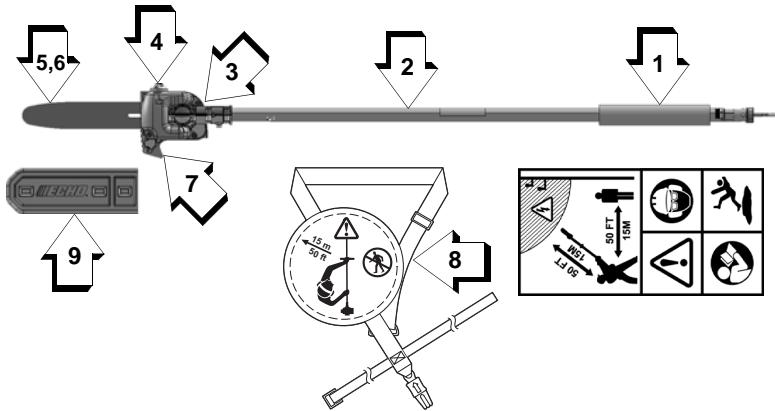

1. SUPPORT HANDLE - FOR LEFT HAND - Cushioned grip.
2. LOWER DRIVE SHAFT ASSEMBLY - Contains a specially designed liner and the flexible drive shaft.
3. CUTTING ATTACHMENT - Sealed, gear ratio is 1.5:1 reduction.
4. AUTOMATIC OILER ASSEMBLY - Self oiling. Use high quality, low viscosity, non-detergent bar and chain oil.
5. SAW CHAIN - Chain, serving as a cutting tool.
6. GUIDE BAR
7. CUTTING SHOE - Used to capture and stabilize branch while cutting. Place cutting shoe against branch, accelerate and lower saw chain into branch.
8. SHOULDER HARNESS - An adjustable strap that suspends the unit from the operator.
9. GUIDE BAR COVER - Used to cover guide bar and saw chain during transport and storage. Remove guide bar cover before using unit.

CONTENTS

The ECHO product you purchased has been factory pre-assembled for your convenience. Due to packaging restrictions, some assembly may be necessary.

After opening the carton, check for damage. Immediately notify your retailer or ECHO Dealer of damaged or missing parts. Use the contents list to check for missing parts.

- 1 Power Pruner Attachment
- 1 Guide Bar Cover
- 1 Shoulder Harness
- 1 Storage Hook Assembly
- 1 Operator's Manual
- 1 Safety Manual
- 1 Warranty Statement

ASSEMBLY

Power Head Shaft To Lower Shaft Assembly

WARNING

Do not perform maintenance or assembly procedures with engine running.

Parts Required: PAS or SRM-SB Power Head Shaft and Coupling

1. Set Power Head/Shaft Assembly on a level surface.
2. Pull locator pin (A) out, and turn counter-clockwise $\frac{1}{4}$ turn to lock-out position.
3. Remove vinyl cap from attachment drive shaft.
4. Remove cardboard spacer, if necessary.



Note: Your coupler may appear different than coupler shown.

- Carefully fit attachment drive shaft assembly into coupler (B) to decal assembly line (C), making sure that the inner lower drive shaft engages the square upper drive shaft socket.

Note: Earlier model power heads may have shorter couplings.

Note: Lower bearing housing and head assembly must be in line with the engine.

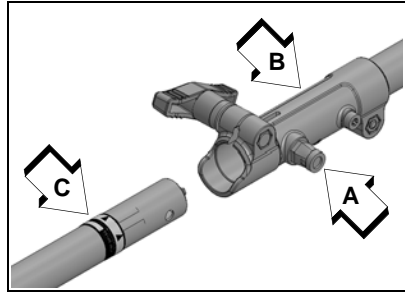

- Rotate locator pin (A) ¼ turn clockwise to engage lower shaft hole. Insure locator pin is fully engaged by twisting lower drive shaft. Locator pin should snap flush in coupler. Full engagement will prevent further shaft rotation.
- Secure lower shaft assembly to coupler by tightening clamping knob (D).

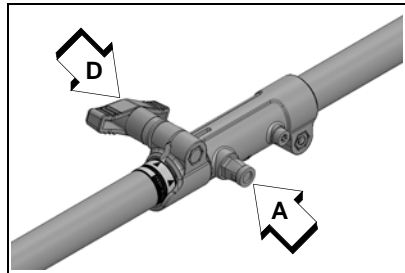

Support Handle Removal

Note: Support handles or support handles with barrier bars are not recommended for use with this attachment.

- Remove support handle assembly, barrier bar (if installed), and mounting hardware from PAS or SRM-SB power head.
- Retain parts for future use.

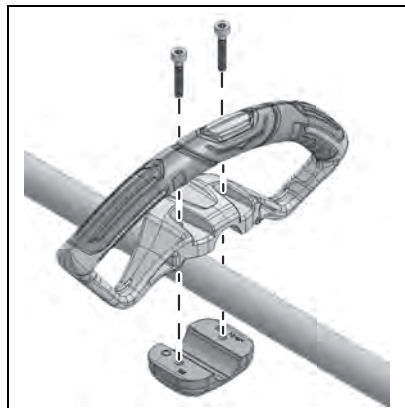

Saw Chain Adjustment

WARNING

Always disconnect spark plug wire before servicing cutting attachment. Wear gloves when handling saw chain, otherwise serious personal injury may result.

1. Move stop switch to STOP position.
2. Disconnect spark plug lead.
3. Loosen two guide bar nuts (A) until finger tight.

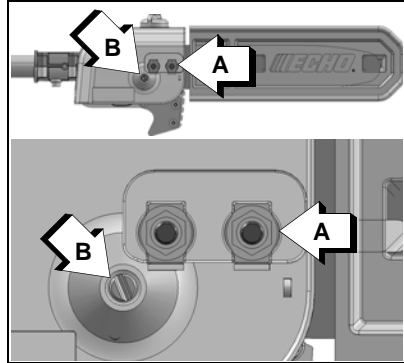

NOTICE

Always loosen guide bar nuts before turning the chain tension adjuster, otherwise the clutch cover and tensioner will be damaged.

4. Hold the bar nose up, and turn the adjuster screw (B) clockwise until the chain fits snugly against the underside of the bar, as shown. Cold Chain Only - turn adjuster screw CW an additional 1/8 - 1/4 turn.
5. Tighten both guide bar nuts with nose held up. Tighten rear nut first.
6. Pull the chain around the guide bar by hand. Reduce the chain tension if you feel tight spots.
7. When chain is properly tensioned, tighten guide bar nuts securely.

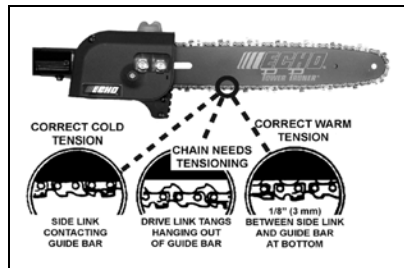

NOTICE

Tighten guide bar nuts to 8 - 9 N•m (71 - 80 in. lbs.). DO NOT over-tighten nuts or damage may result.

8. Keep chain properly tensioned at all times.

Note: All chains require frequent adjustment.

9. Connect spark plug lead.

OPERATION

Note: Refer to your PAS power source Operator's Manuals for correct engine fueling, starting and stopping instructions.

WARNING

Moving parts can amputate fingers or cause severe injuries. Keep hands, clothing and loose objects away from all openings. Always stop engine, disconnect spark plug, and make sure all moving parts have come to a complete stop before removing obstructions, clearing debris, or servicing unit. Allow unit to cool before performing service.

Lubricating the Guide Bar and Saw Chain

Automatic Oiling System

1. Wipe debris from around oil fill cap.
2. Remove oil fill cap and fill reservoir with a quality, low viscosity guide bar and saw chain oil.

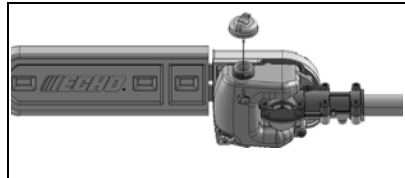

NOTICE

To prevent plastic deterioration, do not use synthetic or silicone based oil.

Adjusting Automatic Oiler

1. From bottom of gear case, turn adjustment screw (A) clockwise to decrease oil volume, or counterclockwise to increase oil volume.

Note: The automatic oiler is preset to deliver a sufficient oil discharge volume during normal operating conditions. During heavy or dry cutting conditions, the oil discharge volume may be increased to assure adequate lubrication. If oil is leaking from the bar cover area, reduce the oil discharge volume. Refill the oil reservoir with each tank of fuel.

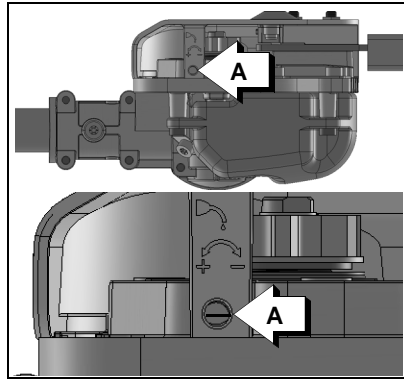

Note: Very little visible oil on the saw chain will provide sufficient lubrication.

Pruning Techniques

Shoulder Harness (if included)

Your harness may appear different than the harness shown.

1. Loosen the harness clamp screw.
2. Put the harness on and attach it to the unit.
3. Adjust the harness for comfortable operation.
4. Tighten the harness clamp screw.



! WARNING

Engine exhaust IS HOT, and contains Carbon Monoxide (CO), a poison gas. Breathing CO can cause unconsciousness, serious injury, or death. Exhaust can cause serious burns. ALWAYS position unit so that exhaust is directed away from your face and body.

The Power Pruner is designed for light to medium trimming of limbs and branches up to 203 mm (8 in.) diameter. Follow these tips for successful operation.

- Plan cut carefully. Check direction branch will fall.
- Plan retreat path from falling branch. Cut branches bounce when striking ground.
- Long branches should be removed in several pieces.
- Do not stand directly beneath branch being cut.
- When ready to cut:
Hold the cutting shoe against the branch. This will prevent whipping of the branch. DO NOT use back and forth sawing action.

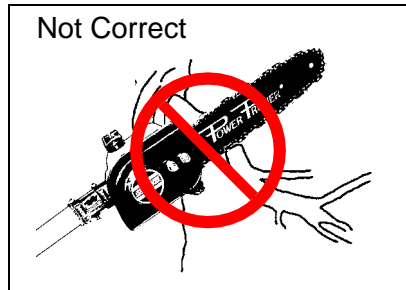
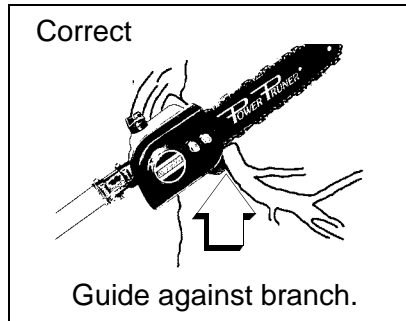

- Look out for branches immediately behind the branch being cut. If saw chain hits a rear branch damage to the saw chain and guide bar may occur.
- Accelerate to full throttle.
- Ease cutting pressure when nearing end of cut to maintain control
- When pruning a limb 102 mm (4 in.) diameter or larger cut as follows:
 1. Under cut 1/4 limb diameter near tree trunk.
 2. Finish top cut slightly farther out on limb.
 3. Flush cut stub at trunk.
- DO NOT use for felling or bucking.

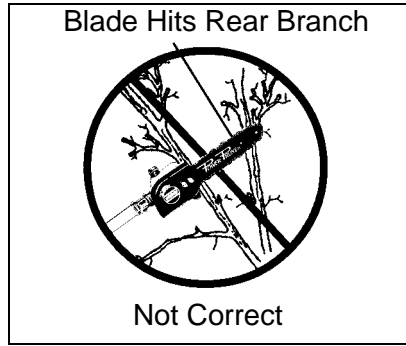

MAINTENANCE

! WARNING

Moving parts can amputate fingers or cause severe injuries. Keep hands, clothing and loose objects away from all openings. Always stop engine, disconnect spark plug, and make sure all moving parts have come to a complete stop before removing obstructions, clearing debris, or servicing unit. Allow unit to cool before performing service. Wear gloves to protect hands from sharp edges and hot surfaces.

Your ECHO unit is designed to provide many hours of trouble free service. Regular scheduled maintenance will help your unit achieve that goal. If you are unsure or are not equipped with the necessary tools, we recommend that you take your unit to an ECHO Servicing Dealer for maintenance. To help you decide whether you want to DO-IT-YOURSELF or have the ECHO Dealer do it, each maintenance task has been graded. If the task is not listed, see your ECHO Dealer for repairs.

Skill Levels

Level 1 = Easy to do. Common tools may be required.

Level 2 = Moderate difficulty. Some specialized tools may be required.

Click [HERE](http://www.echo-usa.com/products/maintenance-kit) or go to <http://www.echo-usa.com/products/maintenance-kit> for information on Maintenance Kits.

Maintenance Intervals

Component	Maintenance Procedure	Skill Level	Interval
Drive Shaft	Apply lithium based grease.	1	Every 25 hours of use.
Guide Bar	Inspect/Clean/Lubricate	2	Before each use.
Saw Chain	Inspect/Sharpen/Replace/Tension		
Screws/Nuts/Bolts	Inspect/Tighten/Replace	1	

IMPORTANT - Time intervals shown are maximum. Actual use and your experience will determine the frequency of required maintenance.

Lubrication

Drive Shaft

Level 1.

Parts Required: Lithium Based Grease

1. Remove cutting attachment locator screw (A).
2. Loosen two bolts (B).
3. Remove cutting attachment assembly.
4. Remove flex cable (C), wipe clean and apply 15 ml (0.5 oz.) of lithium based grease.

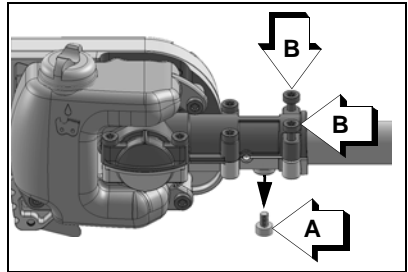

5. Slide the flexible cable back in the drive housing. DO NOT get dirt on the flex cable.
6. Install and secure cutting attachment assembly.

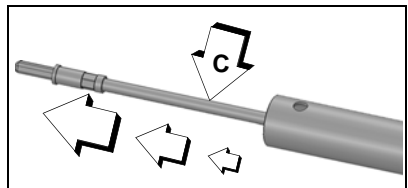

Guide Bar and Saw Chain Replacement

! WARNING

Never try to replace or adjust guide bar and saw chain with engine running. Always disconnect spark plug wire before servicing guide bar and saw chain. This saw chain is VERY sharp, wear heavy gloves to protect your hands when handling it. Wear eye protection meeting CE or ANSI specification Z87.1.

Guide Bar Replacement / Installation

Level 2.

1. Remove two guide bar nuts (A) and sprocket cover screw (B), turn saw chain tension adjustment screw (C) counterclockwise to release tension.

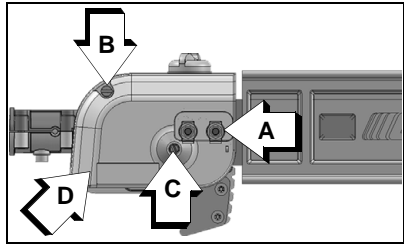

2. Remove guide bar cover (D).
3. Remove guide bar and saw chain from gear case and sprocket.

4. Remove chain from guide bar and check guide bar for damage and excessive or uneven wear. Replace guide bar if necessary

5. Install chain on guide bar with cutters on top of bar facing toward bar tip.
6. Install guide bar and chain on gear case, engaging chain with drive sprocket (E).

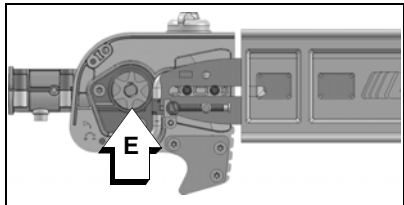

7. Turn tension adjustment screw clockwise to take up slack in saw chain.
8. Install guide bar cover (D), and tighten guide bar nuts finger tight and install guide bar cover screw (B).
9. Adjust chain tension.

Guide Bar Cover Cleaning

1. Remove two guide bar nuts (A) and guide bar cover screw (B).

2. Remove guide bar cover (C).

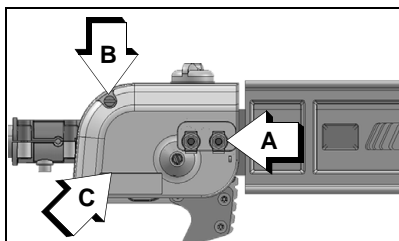

3. Gently brush debris from inside guide bar cover and from around sprocket.

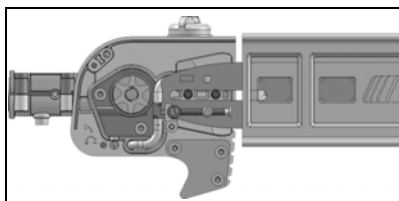

4. Hold the bar nose up. Install guide bar cover (C). Install the guide bar nuts (A). Tighten the rear nut first, then tighten the front nut. Install and tighten the guide bar cover screw (B).

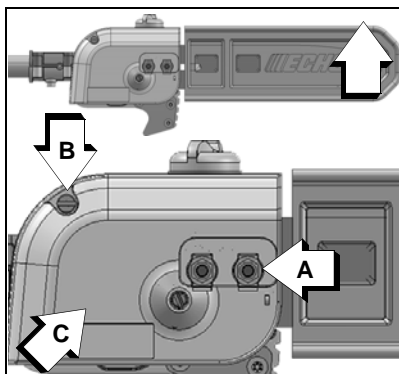

Filing Standard Saw Chain

Level 2

Power Pruner Bar and Chain Combinations					
BAR P/N	CHAIN P/N	CHAIN TYPE	LINKS	PITCH	GUAGE
Narrow Kerf					
254 mm (10 in.) narrow bar P/N 10A4CD3739	90PX39CQ	90	39	9.5 mm (0.375 in.)	0.043
305 mm (12 in.) narrow bar P/N 12A4CD3744	90PX44CQ		44		

Power Pruner Bar and Chain Combinations					
BAR P/N	CHAIN P/N	CHAIN TYPE	LINKS	PITCH	GAUGE
Regular					
254 mm (10 in.) regular bar P/N 10A0CD3739	91VXL39CQ	91	39	9.5 mm (0.375 in.)	0.050
305 mm (12 in.) regular bar P/N 12A0CD3744	91VXL44CQ		44		

NOTICE

Check bar part number on your Power Pruner. Chain and guide bar gauge size must be identical. Use bar and chain combinations shown in table above.

NOTICE

Dull or damaged cutters will result in poor cutting performance, increased vibration, and premature saw chain failure.

WARNING

Always stop engine and disconnect spark plug wire before servicing guide bar and saw chain. Always wear gloves when filing saw chain, otherwise serious personal injury may result.

1. Set round file (A) in cutter at 30° angle. One fifth (1/5) of the file should be exposed above top cutter edge.

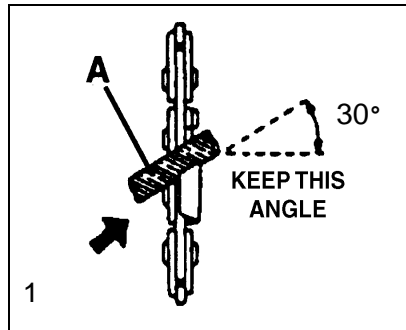

- 2. Keep file horizontal in cutter and file in one direction.

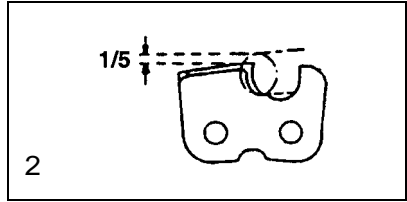

- 3. File until cutter top and side bevel edges are sharp without nicks.

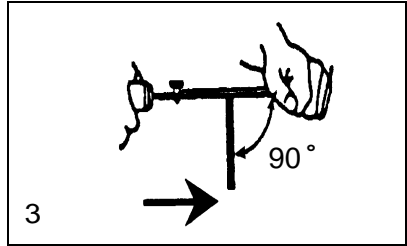

- 4. Place depth gauge tool (B) firmly on top of cutter with 0.635 mm (0.025 in.) slot and end against front cutter raker. File cutter raker with flat file until flush with top of depth gauge.

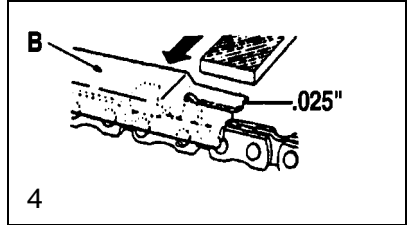

- 5. Finish cutter sharpening by rounding front raker edge (C) with flat file.

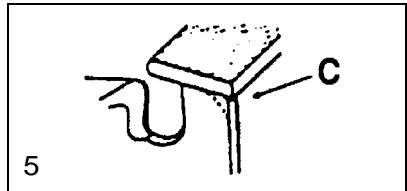

- 6. Properly filed cutter is as shown.
- 7. Apply clean oil and rotate saw chain slowly to wash away filings.
- 8. If saw chain is coated or clogged with resin, clean in kerosene, then soak in oil.

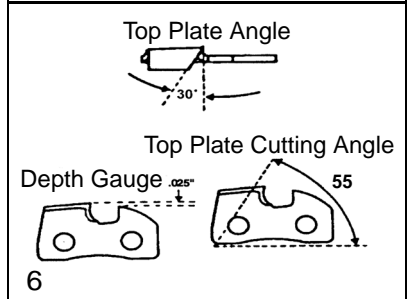

STORAGE

Storage Hook Installation

1. Insert small end of hook into locating hole on attachment shaft.
2. Slide plastic cap onto end of attachment shaft.

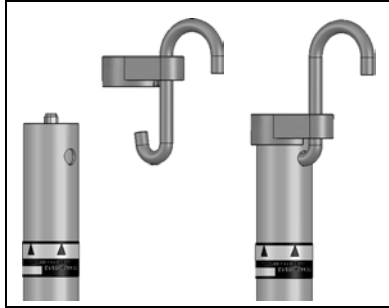

SPECIFICATIONS

MODEL	99944200532
Length	1451 mm (57.1 in.)
Width	105 mm (4.1 in.)
Height	147 mm (5.8 in.)
Weight	2.25 kg (4.96 lbs.)
Drive Shaft Assembly	6.35 mm (0.25 in.) flexible shaft
Rotation Direction	Counter-clockwise
Gear Case Ratio	1.5:1
Handle	Foamed rubber grip
Oiling System	Automatic, 225 ml (7.6 oz.) capacity
Sprocket Type	6 tooth spur, 9.53 mm (0.375 in.) pitch
Guide Bar	1.3 mm (0.050 in.) gauge sprocket nose 254 mm (10 in.)
Chain	Oregon Chain 91VXL-39E
Kick Guard	Without

NOTES

ENGLISH

PRODUCT REGISTRATION

Thank you for choosing ECHO Power Equipment

Please go to <http://www.echo-usa.com/Warranty/Register-Your-ECHO> to register your new product on-line. It's **FAST** and **EASY!** NOTE: your information will never be sold or misused by ECHO, Inc. Registering your purchase enables us to contact you in the unlikely event of a service update or product recall, and verifies your ownership for warranty consideration.

If you do not have access to the Internet, you can complete the form below and mail to:

ECHO Inc., Product Registration, PO Box 1139, Lake Zurich IL 60047.

PRODUCT REGISTRATION CARD : TARJETA DE REGISTRO : CARTE D'ENREGISTREMENT DU PRODUIT

ONLINE OPTION: Register online and save a stamp! You will be alerted of product updates and/or be sent new ECHO product information and special offers. Simply go to: www.echo-usa.com

OPCIÓN POR INTERNET: Regístrese en la página web y ahorre una estampilla! Le alertarán sobre actualizaciones del producto y/o se le enviará información sobre los nuevos productos ECHO y ofertas especiales. Simplemente visite: www.echo-usa.com

OPTION EN LIGNE: Enregistrer en ligne et épargner un timbre! Vous serez informé sur les nouveaux produits ECHO et les mises à jour de produit ainsi que les offres spéciales. Simplement visitez le: www.echo-usa.com

Please Print : Por Favor Enscriba Con Letra De Molde : En Lettre Carré S.V.P.

Confidential: Information provided will not be shared or sold

Purchaser's Name : Nombre del Comprador : Nom de l'acheteur	
Address : Dirección : Adresse	
City : Ciudad : Ville	Zip Code - Código Postal : Code Postal
State : Estado : Province	
E-Mail Address : Dirección De Correo Electrónico : Courriel Electronique	
Phone Number : Número De Teléfono : Téléphone	Date of Purchase : Fecha de la Compra : Date de l'achat
Where Purchased : Nombre del Almacén donde fue Comprado : Lieu d'achat	
Model Number : Numero del Modelo : No. de modèle	Serial Number : Numero de Serie : No. de série

Registering your purchase enables us to contact you in the unlikely event of a service update or product recall and verifies your purchase. We will never give your personal information to a third party without your consent. Please do not provide your phone number or e-mail address unless you are sure you wish to be contacted. We will never give your personal information to a third party without your consent. Please do not provide your phone number or e-mail address unless you are sure you wish to be contacted. L'enregistrement de votre achat nous permettra de vous contacter dans le cas improbable de modifications des instructions d'emballage ou de rappel du produit et vérifier que vous êtes le propriétaire en cas de vol ou de perte.

Primary use of tool: Homeowner Rental Equip.

Uso primario de la herramienta: Profesional Dueño de casa Alquiler

Usage principal: Professionnel Résidentiel Location

Do you wish to receive periodic ECHO product information and special offers by e-mail? Yes No

¿Desea usted recibir información periódica y ofertas especiales por correo electrónico sobre el producto ECHO? Yes No

Souhaitez-vous recevoir périodiquement de l'information sur les produits ECHO et les offres spéciales par courrier électronique? Oui Non

Did you visit the ECHO website before purchasing your product? Yes No

Visité usted la página web ECHO antes de comprar su producto? Si No

Avez-vous visité le site d'ECHO avant de procurer votre produit? Oui Non

What factor(s) most influenced your purchase? Dealer

Performance Price Quality

Reliability Prior Experience Warranty

Friend/Family Brand Distributor

Functionality Precio Calidad

Confiabilidad Experiencia Anterior Garantía

Amigo/Familia Marca Marchand

Performance Prix Expérience

Fiabilité Marque Garantie

Amil/Famille Expérience Qualité

Garantie

ECHO INC., 400 Oakwood Rd., Lake Zurich, IL 60047
1.800.432.ECHO WWW.ECHO-USA.COM

X7572270206 02-2012

ENGLISH

S06800097461 - S06800999999



ECHO, INCORPORATED

400 Oakwood Road
Lake Zurich, IL 60047

www.echo-usa.com