



Operator's Manual DHC-2300 Hedge Trimmer

WARNING

This product contains chemicals known to the State of California to cause cancer, birth defects, or other reproductive harm. Cancer and Reproductive Harm www.P65Warnings.ca.gov

WARNING



Read and understand all provided literature before use. Failure to do so could result in serious injury.

TABLE OF CONTENTS

Introduction.....3

Servicing Information.....3

 Parts / Serial Number.....3

 Service.....4

 ECHO Consumer Product Support.....4

 Product Registration.....4

 Additional Literature.....4

Packing List.....4

Safety.....5

 Manual Safety Symbols and Important Information.....5

 International Symbols6

 General Power Tool Safety Warnings.....7

 Hedge Trimmer Safety Warnings.....10

 Recommended Ambient Temperature Range.....11

 Environmentally Safe Battery Disposal.....12

Description.....13

Operation.....15

 Starting The Unit.....15

 Stopping The Unit.....16

 Operation Tips17

Maintenance.....18

 Skill Levels.....18

 Maintenance Intervals.....18

 Cleaning Battery And Battery Compartme19

 Lubricate The Blade19

Troubleshooting.....20

Storage.....21

 Storage After Use21

Specifications.....22

Product Registration.....23

Warranty.....25

INTRODUCTION

Specifications, descriptions and illustrative material in this literature are as accurate as known at the time of publication, but are subject to change without notice. Illustrations may include optional equipment and accessories, and may not include all standard equipment.



Read and understand all provided literature. Literature contains specifications and information for safety, operation, maintenance, storage, and assembly specific to this product. Scan QR codes for more information.



For additional literature, including safety manuals where applicable, or questions regarding terms used in this manual, visit:

<https://www.echo-usa.com/manuals>



SERVICING INFORMATION

Parts / Serial Number

Genuine ECHO Parts and Assemblies for your ECHO products are available only from an Authorized ECHO Dealer. When you do need to buy parts always have the Model Number and Serial Number of the unit with you. For future reference write them in the space provided below.

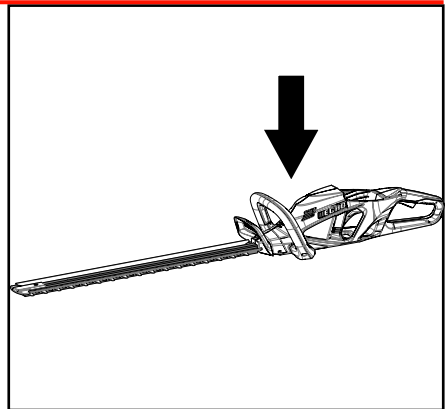

Model No. _____

Serial No. _____

Service

Service of this product during the warranty period must be performed by an Authorized ECHO Service Dealer. For the name and address of the Authorized ECHO Service Dealer nearest you, ask your retailer or call: 1-800-432-ECHO (3246). Dealer information is also available on our Web Site www.echo-usa.com. When presenting your unit for Warranty service/repairs, proof of purchase is required.

ECHO Consumer Product Support

If you require assistance or have questions concerning the application, operation, or maintenance of this product, call the ECHO Consumer Product Support Department at 1-800-432-ECHO (3246) from 8:00 am to 5:00 pm (Central Standard Time) Monday through Friday. Before calling, please know the model and serial number of your unit.

Product Registration

Register your ECHO equipment online at www.echo-usa.com or by filling out the product registration sheet included in this manual. Registering your product confirms warranty coverage and provides a direct link to ECHO if we find it necessary to contact you.

Additional Literature

In addition to finding information online, information is available from your Authorized ECHO Service Dealer, or by contacting ECHO Incorporated, 400 Oakwood Road, Lake Zurich, IL 60047, 1-800-432-ECHO (3246).

PACKING LIST

The ECHO product you purchased has been factory pre-assembled for your convenience. Due to packaging restrictions, some assembly may be necessary.

After opening the carton, check for damage. Immediately notify your retailer or ECHO Dealer of damaged or missing parts. Use the contents list to check for missing parts.

- 1 Hedge Trimmer
- 1 Operator's Manual
- 1 Scabbard

SAFETY

Manual Safety Symbols and Important Information

Throughout this manual and on the product itself, you will find safety alerts and helpful, informational messages preceded by symbols or key words. The following is an explanation of those symbols and key words and what they mean to you.

DANGER

The safety alert symbol accompanied by the word “DANGER” calls attention to an act or condition which WILL lead to serious personal injury or death if not avoided.

WARNING

The safety alert symbol accompanied by the word “WARNING” calls attention to an act or condition which CAN lead to serious personal injury or death if not avoided.

CAUTION

The safety alert symbol accompanied by the word “CAUTION” calls attention to an act or condition which might lead to minor or moderate personal injury if not avoided.

NOTICE

The enclosed message provides information necessary for the protection of the unit.

Note: This enclosed message provides tips for use, care and maintenance of the unit.













CIRCLE AND SLASH SYMBOL

This symbol means the specific action shown is prohibited. Ignoring these prohibitions can result in serious or fatal injury.

International Symbols

Some of the following symbols may be used on this product. Please study them and learn their meaning. Proper interpretation of these symbols will allow you to operate the product better and safer.

Symbol	Description	Symbol	Description
	WARNING! Read and follow all safety precautions in the operator's manual. Failure to follow instructions could result in serious personal injury.		Keep all bystanders at least 15m (50ft) away.
	Safety / Alert		Do not expose the product to rain or moist conditions.
	Thrown objects can ricochet and result in personal injury or property damage. Wear protective clothing and boots.		Danger – keep hands and feet away from blade.
	Wear non-slip, heavy duty gloves.		Direct current
	Wear Eye and Ear Protection		Volts
	Environmentally safe battery disposal		

General Power Tool Safety Warnings

WARNING

Read all safety warnings, instructions, illustrations and specifications provided this power tool. *Failure to follow the warnings and instructions may result in electric shock fire and/or serious injury.*

Save all warnings and instructions for future reference.

The term "power tool" in the warnings refers to your mains-operated (corded) power tool or BATTERY-operated (cordless) power tool.

Work Area Safety

- **Keep work area clean and well lit.** *Cluttered or dark areas invite accidents.*
- **Do not operate power tools in explosive atmospheres, such as in the presence of flammable liquids, gases or dust.** *Power tools create sparks which may ignite the dust or fumes.*
- **Keep children and bystanders away while operating a power tool.** *Distractions can cause you to lose control.*

Electrical Safety

- **Power tool plugs must match the outlet. Never modify the plug in any way. Do not use any adapter plugs with earthed (grounded) power tools.** *Unmodified plugs and matching outlets will reduce risk of electric shock.*
- **Avoid body contact with earthed or grounded surfaces, such as pipes, radiators, ranges and refrigerators.** *There is an increased risk of electric shock if your body is earthed or grounded.*
- **Do not expose power tools to rain or wet conditions.** *Water entering a power tool will increase the risk of electric shock.*
- **Do not abuse the cord. Never use the cord for carrying, pulling or unplugging the power tool. Keep cord away from heat, oil, sharp edges or moving parts.** *Damaged or entangled cords increase the risk of electric shock.*
- **When operating a power tool outdoors, use an extension cord suitable for outdoor use.** *Use of a cord suitable for outdoor use reduces the risk of electric shock.*

- **If operating a power tool in a damp location is unavoidable, use a RESIDUAL CURRENT DEVICE (RCD) protected supply.** *Use of an RCD reduces the risk of electric shock.*

Personal Safety

- **Stay alert, watch what you are doing and use common sense when operating a power tool. Do not use a power tool while you are tired or under the influence of drugs, alcohol or medication.** *A moment of inattention while operating power tools may result in serious personal injury.*
- **Use personal protective equipment. Always wear eye protection.** *Protective equipment such as a dust mask, non-skid safety shoes, hard hat or hearing protection used appropriately will reduce personal injuries.*
- **Prevent unintentional starting. Ensure the switch is in the off position before connecting to power source and/or battery and when picking up or carrying the tool.** *Carrying power tools with your finger on the switch or energizing power tools that have the switch on invites accidents.*
- **Remove any adjusting key or wrench before turning the power tool on.** *A wrench or a key left attached to a rotating part of the power tool may result in personal injury.*
- **Do not over-reach. Keep proper footing and balance at all times.** *This enables better control of the power tool in unexpected situations.*
- **Dress properly. Do not wear loose clothing or jewelry. Keep your hair, clothing and gloves away from moving parts.** *Loose clothes, jewelry or long hair can be caught in moving parts.*
- **If devices are provided for the connection of dust extraction and collection facilities, ensure these are connected and properly used.** *Use of dust collection can reduce dust related hazards.*
- **Do not let familiarity gained from frequent use of tools allow you to become complacent and ignore tool safety principles.** *A careless action can cause severe injury within a fraction of a second.*

Power Tool Use and Care

- **Do not force the power tool. Use the correct power tool for your application.** *The correct power tool will do the job better and safer at the rate for which it was designed.*
- **Do not use the power tool if the switch does not turn it on and off.** *Any power tool that cannot be controlled with the switch is dangerous and must be repaired.*
- **Disconnect the plug from the power source and/or remove the battery, from the power tool before making any adjustments,**

changing accessories, or storing power tools. *Such preventive safety measures reduce the risk of starting the power tool accidentally.*

- **Store idle power tools out of the reach of children and do not allow persons unfamiliar with the power tool or these instructions to operate the power tool.** *Power tools are dangerous in the hands of untrained users.*
- **Maintain power tools and accessories. Check for misalignment or binding of moving parts, breakage of parts and any other condition that may affect the power tool's operation. If damaged, have the power tool repaired before use.** *Many accidents are caused by poorly maintained power tools.*
- **Keep cutting tools sharp and clean.** *Properly maintained cutting tools with sharp cutting edges are less likely to bind and are easier to control.*
- **Use the power tool and accessories in accordance with these instructions, taking into account the working conditions and the work to be performed.** *Use of the power tool for operations different from those intended could result in a hazardous situation.*
- **Keep handles and grasping surfaces dry, clean and free from oil and grease.** *Slippery handles and grasping surfaces do not allow for safe handling and control of the tool in unexpected situations.*

Battery Tool Use and Care

- **Recharge only with ECHO eFORCE™ 56V battery series chargers.** *A charger that is suitable for one type of battery may create a risk of fire when used with another battery.*
- **Use only with ECHO eFORCE™ 56V battery series.** *Use of any other batteries may create a risk of injury and fire.*
- **When battery is not in use, keep it away from other metal objects like paper clips, coins, keys, nails, screws, or other small metal objects that can make a connection from one terminal to another.** *Shorting the battery terminals together may cause burns or fire.*
- **Do not open or destroy the battery.** *Electrolytes contained within the battery are corrosive and may cause damage to eyes or skin if released. It may be toxic if swallowed.*
- **Under abusive conditions, liquid may be ejected from the battery; avoid contact. If contact accidentally occurs, flush with water. If liquid contacts eyes, additionally seek medical help.** *Liquid ejected from the battery may cause irritation or burns.*
- **Exercise care in handling batteries to avoid shorting the battery with conducting materials such as rings, bracelets, keys, etc.** *The*

battery or conductor may overheat and cause burns if contact with said materials is made.

- **Do not use a battery or tool that is damaged or modified.** *Damaged or modified batteries may exhibit unpredictable behavior resulting in fire, explosion or risk of injury.*
- **Do not expose a battery or tool to fire or excessive temperature.** *Exposure to fire or temperature above 266 °F (130 °C) may cause explosion.*
- **Follow all charging instructions and do not charge the battery or tool outside the temperature range specified in the instructions.** *Charging improperly or at temperatures outside the specified range may damage the battery and increase the risk of fire.*

Child Safety

Tragic accidents can occur if the operator is not aware of the presence of children.

- Keep children out of the working area and under the watchful care of a responsible adult.
- Do not allow children to operate this machine.
- Stay alert, and turn the machine off if a child or any other person enters the working area.
- Use extreme care when approaching blind corners, doorways, shrubs, trees, or other objects that may obscure your view of a child who may run into the path of the machine.

Service

- **Have your power tool serviced by a qualified repair person using only identical replacement parts.** *This will ensure that the safety of the power tool is maintained.*
- **Never service damaged batteries.** *Service of batteries should only be performed by the manufacturer or authorized service providers.*

Hedge Trimmer Safety Warnings

- **Keep all parts of the body away from the blade.** *Do not remove cut material or hold material to be cut when blades are moving. Blades continue to move after the trigger switch is released. A moment of inattention while operating the hedge trimmer may result in serious personal injury.*
- **Carry the hedge trimmer by the handle with the blade stopped and taking care not to operate any power switch.** *Proper carrying of the hedge trimmer will decrease the risk of inadvertent starting and resultant personal injury from the blades.*

- **When transporting or storing the hedge trimmer, always install the scabbard.** *Proper handling of the hedge trimmer will decrease the risk of personal injury from the blades.*
- **When clearing jammed material or servicing the unit, make sure all power switches are off and the battery is removed.** *Unexpected starting of the hedge trimmer while clearing jammed material or servicing may result in serious personal injury.*
- **Hold the hedge trimmer by insulated gripping surfaces only, because the blade may contact hidden wiring.** *Blades contacting a "live" wire may make exposed metal parts of the hedge trimmer "live" and could give the operator an electric shock.*
- **Keep all power cords and cables away from cutting area.** *Power cords or cables may be hidden in hedges or bushes and can be accidentally cut by the blade.*
- **Do not use the hedge trimmer in bad weather conditions, especially when there is a risk of lightning.** *This decreases the risk of being struck by lightning.*
- **Keep a Solid Stance.** *Maintain footing and balance at all times. Do not stand on slippery, uneven or unstable surfaces. Do not work in odd positions or on ladders. Do not over reach.*

Recommended Ambient Temperature Range

Item	Temperature
Power tool storage temperature range	32 °F (0 °C) ~ 113 °F (45 °C)
Power tool operation temperature range	32 °F (0 °C) ~ 113 °F (45 °C)
Battery charging temperature	39 °F (4 °C) ~ 104 °F (40 °C)
Charger operation temperature range	39 °F (4 °C) ~ 104 °F (40 °C)
Battery storage temperature range	32 °F (0 °C) ~ 113 °F (45 °C)
Battery discharging temperature range	32 °F (0 °C) ~ 113 °F (45 °C)

Environmentally Safe Battery Disposal



The toxic and corrosive materials below are in the batteries used in this machine: Lithium-Ion, a toxic material.

Discard all toxic materials in a specified manner to prevent contamination of the environment. Before discarding damaged or worn out Li-ion battery, contact your local waste disposal agency, or the local Environmental Protection Agency for information and specific instructions. Take the batteries to a local recycling and/or disposal center, certified for lithium-ion disposal.

If the battery cracks or breaks, with or without leaks, do not recharge it and do not use. Discard it and replace with a new battery. DO NOT TRY TO REPAIR IT! To prevent injury and risk of fire, explosion, or electric shock, and to avoid damage to the environment:

Cover the terminals of the battery with heavy-duty adhesive tape. DO NOT try to remove or destroy any of the battery components. DO NOT try to open the battery.

If a leak develops, the released electrolytes are corrosive and toxic. DO NOT get the solution in the eyes or on skin, and do not swallow it.

DO NOT put these batteries in your regular household trash. DO NOT incinerate.

DO NOT put them where they will become part of any waste landfill or municipal solid waste stream.

Take them to a certified recycling or disposal center.

DESCRIPTION

Locate the safety label(s) on your unit. Make sure the label(s) is legible and that you understand and follow the instructions on it. If a label cannot be read, a new one can be ordered from your ECHO dealer. Safety label is for example only. Your label may appear slightly different.

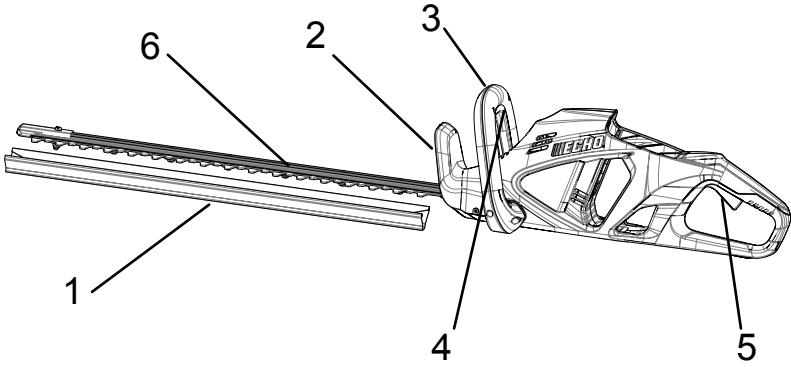

1. Scabbard
2. Guard
3. Front handle
4. Front handle operator presence switch
5. Trigger switch
6. Blade

Installing and Removing the Battery

WARNING

The hedge trimmer will operate when the battery is installed, the power indicator LED is lit, and the trigger switch and front handle operator presence switch are engaged. Make sure the hedge trimmer is properly positioned to prevent loss of control and possible serious injury. Keep movable parts of the hedge trimmer off the ground and away from objects that could become entangled.

NOTICE

The battery comes partially charged from the factory and needs to be fully charged before first use.

Note: See separate Operator's Manual Packaged with the Battery.

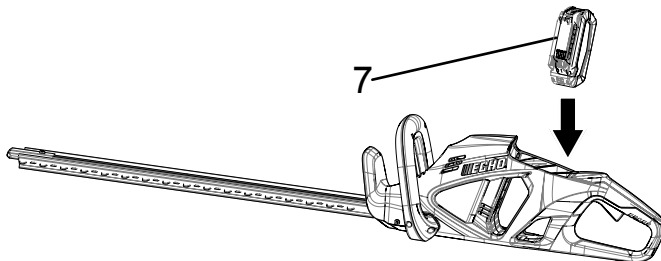

Installing the Battery

- If the battery or charger is damaged, replace the battery or the charger.
 - Stop the machine and wait until the motor stops before you install or remove the battery.
 - Read, know, and follow the instructions in the battery and charger manuals.
1. Align the ridges on the battery with the grooves in the battery compartment.
 2. Push the battery into the battery compartment until the battery locks into place.
 3. When you hear a click, the battery is installed.

Remove the Battery

1. Push and hold the battery (7) release button.
2. Remove the battery from the machine.

WARNING

Moving parts can amputate fingers or cause severe injuries. Keep hands, clothing and loose objects away from all openings. Always stop motor, remove battery, and make sure all moving parts have come to a complete stop before removing obstructions, clearing debris, or servicing unit.

- Do not put your fingers into the notches or in position where they can get cut.
- Do not touch the blade unless you removed the battery.
- Do not use the hedge trimmer if the blade is damaged or bent.
- Remove all objects such as cords, lights, wire, or string from the cutting area which can become entangled in the cutting blade and create a risk of personal injury.

WARNING

If the blade jams on an electrical cord or line, DO NOT TOUCH THE BLADE! IT CAN BE LIFE THREATENING AND DANGEROUS. Follow the steps below:

1. Hold the insulated rear handle or put the machine down and away from you.
2. Disconnect the electrical service to the damaged line or cord before you try to free the blade.

Starting the Unit

WARNING

When starting the unit, observe the precautions described in the "Safety" section. Failure to observe the precautions could cause an accident or injury, or even lead to a fatality.

1. Push and hold the front handle operator presence switch (4) with one hand.
2. Push the trigger switch (5) with the other hand.

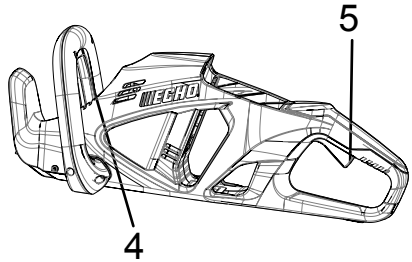

⚠ WARNING

Hold the machine with both hands during operation.

Stopping the Unit

Release front handle operator presence switch and trigger switch, and allow hedge trimmer to stop.

NOTICE

If the hedge trimmer does not stop when the front handle operator presence switch and trigger switch are released, remove the battery to stop the power supply to hedge trimmer. Have your authorized ECHO servicing dealer repair unit before using again. If the machine accidentally falls, it will stop and the blade will fully stop after a few seconds.

Operation Tips

1. Do not force the machine through heavy shrubbery. This can cause blade blockage. If the blades stop because of blockage:
 - Release the trigger switch and let blades come to complete stop
 - Remove battery
 - Remove blockage
2. Wear protection gloves when you cut.
3. Cut the new growth with a wide sweeping action so that the stems are put directly into the blade.

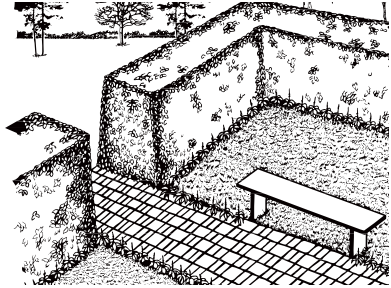

5. You can use a string to adjust the height of the hedge.
6. Stretch a piece of string along the hedge at the desired height.
7. Cut the hedge immediately above this string.
8. Cut the side of a hedge until it will be narrower at the top. More of the hedge will come into view in that way.

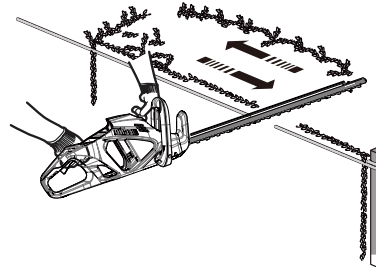

⚠ WARNING

Moving parts can amputate fingers or cause severe injuries. Keep hands, clothing and loose objects away from all openings. Always stop motor, and make sure all moving parts have come to a complete stop before removing obstructions, clearing debris, or servicing unit. Allow unit to cool before performing service. Wear gloves to protect hands from sharp edges and hot surfaces.

⚠ WARNING

Operating a poorly maintained unit can result in serious injuries to operator or bystanders. Always follow all maintenance instructions as written, otherwise serious personal injury can result.

Your unit is designed to provide many hours of trouble free service. Regular scheduled maintenance will help your unit achieve that goal. If you are unsure or are not equipped with the necessary tools, we recommend that you take your unit to a Servicing Dealer for maintenance. To help you decide whether you want to DO-IT-YOURSELF or have the Dealer do it, each maintenance task has been graded. If the task is not listed, see your Dealer for repairs.

Skill Levels

Level 1 = Easy to do. Common tools may be required.

Level 2 = Moderate difficulty. Some specialized tools may be required.

Level 3 = See your dealer.

Maintenance Intervals

COMPONENT/SYSTEM	MAINTENANCE PROCEDURE	REQUIRED SKILL LEVEL
Daily or Before Use		
Battery and Battery Compartment	Inspect/Clean *	1
Screws/Nuts/Bolts	Inspect/Tighten/Replace *	
Blades	Inspect/Clean ¹	

IMPORTANT NOTE - Time intervals shown are maximum. Actual use and your experience will determine the frequency of required maintenance.

MAINTENANCE PROCEDURE NOTES:

1 Inspect blade, and clean as needed.

* Replacement is recommended based on the finding of damage or wear during inspection.

Cleaning Battery and Battery Compartment

WARNING

Risk of electric shock or fire. Do not use conducting materials to clean battery or battery compartment.

- Use compressed air or a soft bristle brush to remove debris from battery and battery compartment
- Use a small soft bristle brush to clean the air vents.

Lubricate the Blade

To increase the efficiency and life of the blades, lubricate them carefully after each work session:

- Put the machine on a flat and smooth surface.
- Use a soft cloth and a brush to clean the blades.
- Use a light layer of oil to lubricate the blades along the top edge of the blade.

NOTICE

We recommend the use of Red Armor® Blade Cleaner and Lubricant

TROUBLESHOOTING

Problem	Cause	Solution
The motor does not start when you pull the trigger switch.	The battery is not installed tightly.	Make sure that you tightly install the battery in the machine.
	The battery is out of power.	Charge the battery.
	The front handle operator presence switch is not engaged.	Engage the front handle operator presence switch.
The machine smokes during operation.	The machine has damage.	<ol style="list-style-type: none">1. Immediately stop the machine.2. Remove the battery.3. Contact your dealer.
The motor is on, blades do not move.	The machine has damage.	Do not use the machine and contact your dealer.
	The blades are blocked.	Remove battery then clear blockage from the blades.
There is too much noise and/or vibration during operation.	The parts are loosen.	<ol style="list-style-type: none">1. Stop the machine.2. Remove the battery.3. Inspect for damage.4. Check and tighten loose parts.
	The parts have damage.	Do not use the machine and contact your dealer.

STORAGE

Storage After Use

When storing the product for long periods of time, ensure that the following preparations for storage are carried out.

Hedge Trimmer

Do not store your unit without performing protective storage maintenance which includes the following:

1. Turn power to unit off.
2. Remove battery from hedge trimmer.
3. Remove accumulation of dirt and debris from exterior of unit.
4. Tighten all screws and nuts.
5. Install blade scabbard.
6. Cover battery compartment of hedge trimmer.
7. Store unit in a dry, dust-free place, out of the reach of children.

Battery

1. Remove battery from hedge trimmer.
2. Store in a dry, dust-free place, out of the reach of children.
3. Store in temperatures between -4°F (-20°C) and 140°F (60°C) .
4. If battery is stored for longer than six months, charge it to 100% capacity.

Charger

1. Remove battery from charger.
2. Disconnect charger from power supply.
3. Store in a dry, dust-free place, out of the reach of children.

SPECIFICATIONS

Voltage	56V
No load speed	3200 SPM
Blade length	22" (552 mm)
Cutting capacity	1.1" (28 mm)
Weight (without battery)	6.7 lbs (3.05 kg)
Battery: Model Type Voltage Charger type Charger input voltage	ECHO eFORCE™ 56V battery series batteries Li-Ion 56 (rated 50.4) CCCV 120V AC 60Hz
Charger model	ECHO eFORCE™ 56V battery series charger

PRODUCT REGISTRATION

Thank you for choosing ECHO Power Equipment

Please go to <http://www.echo-usa.com/Warranty/Register-Your-ECHO> to register your new product online. It's FAST and EASY! NOTE: your information will never be sold or misused by ECHO, Incorporated.

Registering your purchase enables us to contact you in the unlikely event of a service update or product recall, and verifies your ownership for warranty consideration.

If you do not have access to the Internet, you can complete the form below and mail to:

***ECHO Incorporated, Product Registration, PO Box 1139,
Lake Zurich, IL 60047.***



PRODUCT REGISTRATION CARD : TARJETA DE REGISTRO : CARTE D'ENREGISTREMENT DU PRODUIT

ONLINE OPTION: Register online and save a stamp! You will be alerted of product updates and/or be sent new ECHO product information and special offers. Simply go to: www.echo-usa.com

OPCIÓN POR INTERNET: Regístrese en la página web y ahorre una estampilla! Le alertarán sobre actualizaciones de producto y/o se le enviara información sobre los nuevos productos ECHO y las ofertas especiales. Simplemente visite: www.echo-usa.com

OPTION EN LIGNE: Enregistrez en ligne et épargner un timbre! Vous serez informé sur les nouveaux produits ECHO et les mises à jour de produit ainsi que les offres spéciales. Simplementement visitez: www.echo-usa.com

Please Print : Por Favor Escribe Con Letra De Molde : En Lettre Carré S.V.P. Confidential: Information provided will not be shared or sold

Purchaser's Name : Nombre del Comprador : Nom de l'acheteur _____	
Address : Dirección : Adresse _____ _____	Zip Code : Código Postal : Code Postal _____
City : Ciudad : Ville _____	State : Estado : Province _____
E-Mail Address : Dirección De Correo Electrónico : Courrier Electronique _____	
Phone Number : Número De Teléfono : Téléphone _____	Date of Purchase : Fecha de la Compra : Date de l'achat _____
Where Purchased : Nombre del Almacén donde fue Comprado : Lieu d'achat _____	
Model Number : Numero del Modelo: No. de modèle Serial Number : Numero de Serie : No. de série _____	

Registering your purchase enables us to contact you in the unlikely event of a service update or product recall and verifies your ownership in the event of loss. El registrar su compra nos permite estar en contacto con usted en caso de cualquier evento como el aviso de tiempo de servicio o la revocación del producto y verificación de propiedad en caso de robo o pérdida. L'enregistrement de votre achat nous permettra de vous contacter dans le cas improbable de modifications des instructions d'utilisation ou de rappel du produit et vérifier que vous êtes le propriétaire en cas de vol ou de perte.

Primary use of tool: Professional Homeowner Rental Equip.
 Uso primario de la herramienta: Profesional Dueño de casa Alquiler
 Usage principal: Professionnel Résidentiel Locataire
 Do you wish to receive periodic ECHO product information and special offers by e-mail? Yes No
 ¿Desea usted recibir información periódica y ofertas especiales por correo electrónico sobre el producto ECHO? Yes No
 Souhaitez-vous recevoir périodiquement de l'information sur les produits ECHO et les offres spéciales par courrier électronique ? Oui Non
 Did you visit the ECHO website before purchasing your product? Yes No
 Visité usted la página web ECHO antes de comprar su producto? Si No
 Avez-vous visité le site d'ECHO avant de procurer votre produit? Oui Non

What factor(s) most influenced your purchase?
 Performance Price Dealer
 Reliability Prior Experience Quality Warranty
 Friend/Family Brand Friend/Family
 Funcionamiento Precio Distribuidor
 Confiabilidad Experiencia Anterior Calidad Garantía
 Amigo/Familia Marca Garantía
 Quel facteur (facteurs) vous a influencé le plus?
 Performance Prix Marchand
 Fiabilité Expérience Qualité Garantie
 Ami/Famille Marque Garantie

ECHO INC., 400 Oakwood Rd., Lake Zurich, IL 60047
 1.800.432.ECHO WWW.ECHO-USA.COM X7572270206 02-2012



**Limited Warranty Statement for ECHO 56 Volt
Products sold in USA and Canada**

ECHO Incorporated warrants to the original retail purchaser that this ECHO brand 56 Volt outdoor product is free from defects in material and workmanship and agrees to repair or replace, at ECHO Incorporated's discretion, any defective product free of charge within these time periods from the date of purchase:

- If the product is for homeowner use:
 - Unit – 5 Years
 - Battery or charger – 2 years
- If the product is for commercial use:
 - Chainsaw – 1 year
 - All other units – 2 years
 - Battery or charger – 1 year
- If the product is for rental use: 90 days for all units, batteries, and chargers.
- Cutting attachments such as, but not limited to, bars, chains, sprockets, blades, tines, belts, PowerBroom™ and nylon trimmer heads for homeowner or non-income producing use will be covered for failures due to defects in material or workmanship for a period of 60 days from original product purchase date and 30 days for commercial / rental use. Any misuse from contact with concrete, rocks, or other structures is not covered by this warranty.

This warranty extends to the original retail purchaser only and commences on the date of the original retail purchase.

Any part of this product found in the reasonable judgment of ECHO Incorporated, to be defective in material or workmanship will be repaired or replaced without charge for parts and labor by an authorized ECHO dealer. Units, repair parts and accessories replaced under this warranty are warranted only for the balance of the original warranty period.

The product, including any defective part, must be returned to an authorized ECHO dealer within the warranty period. The expense of delivering the product to the service center for warranty work and the expense of returning it back to the owner after repair or replacement will be paid by the owner. ECHO Incorporated's, responsibility in respect to claims is limited to making the required repairs or replacements and no claim of breach of warranty shall be cause for cancellation or rescission of the contract of sale of any ECHO brand 56 Volt outdoor product. Proof of purchase will be required by the dealer to substantiate any warranty claim. All warranty work must be performed by an authorized ECHO dealer.

This warranty does not cover any product that has been subject to misuse, neglect, negligence, or accident, or that has been operated in any way contrary to the operating instructions as specified in the Operator's Manual.

This warranty does not apply to any damage to the product that is the result of improper maintenance or to any product that has been altered or modified. The warranty does not extend to repairs made necessary by normal wear or by the use of parts or accessories which are either incompatible with the ECHO brand 56 Volt outdoor product or adversely affect its operation, performance, or durability. In addition, this warranty does not cover wear to normal items such as, but not limited to:

Wear items – Bump Knobs, Outer Spools, Cutting Lines, Inner Reels, Felt Washers, Hitch Pins, Mulching Blades, Blower Fans, Blower and Vacuum Tubes, Vacuum Bag and Straps, Guide Bars, Saw Chains, Grass Catch Bag, Hedge Trimmer Blades, and Wheels

ECHO Incorporated, reserves the right to change or improve the design of this product without assuming any obligation to modify any product previously manufactured.

All implied warranties are limited in duration to the stated warranty period. Accordingly, any such implied warranties including merchantability, fitness for a particular purpose, or otherwise, are disclaimed in their entirety after the expiration of the appropriate five-year, two-year, one-year, 90-day, 60-day, or 30-day warranty period. ECHO Incorporated's obligation under this warranty is strictly and exclusively limited to the repair or replacement of defective parts. ECHO Incorporated, does not assume or authorize anyone to assume for them any other obligation. Some states do not allow limitations on how long an implied warranty lasts, so the above limitation may not apply to you. ECHO Incorporated, assumes no responsibility for incidental, consequential, or other damages including, but not limited to, expense of returning the product to an authorized dealer for ECHO brand 56 Volt outdoor products and expense of delivering it back to the owner, mechanic's travel time, telephone charges, rental of a like product during the time warranty service is being performed, travel, loss or damage to personal property, loss of revenue, loss of use of the product, loss of time, or inconvenience. Some states do not allow the exclusion or limitation of incidental or consequential damages, so the above limitation or exclusion may not apply to you.

This warranty gives you specific legal rights, and you may also have other rights which vary from state to state.

This warranty applies to all ECHO brand 56 Volt outdoor products manufactured by or for ECHO Incorporated, and sold in the United States and Canada.

To locate your nearest authorized ECHO dealer, visit www.ECHO-usa.com or dial 1-800-432-ECHO (3246).

NOTES

403HCH000001 - 403HCH999999



ECHO INCORPORATED
400 Oakwood Road
Lake Zurich, IL 60047
www.echo-usa.com