

Installation / Assembly Procedure and Parts Book



Orbit Reel™ Trac II Kits for All Models of HCC Tube Type Reels

The Orbit Reel™ Trac II Kit installation instructions in this manual are generic, covering a wide variety of OEM equipment.

For Orbit Reel™ Trac II Kits Produced After January 1, 2010
US Patent # 7,665,287 B2

HCC, Inc.
1501 1st Avenue
Mendota, IL 61342
815-539-9371
www.hccincorporated.com

C-1096-04
March 2010

Safety

Most work related accidents are caused by failure to observe basic safety rules or precautions. An accident can often be avoided by recognizing potentially hazardous situations before an accident occurs. As you install the Orbit Reel™ Kit, you must be alert to potential hazards. You should also have the necessary training, skills, and tools to perform this installation properly.

Improper installation of this kit could cause the reel to function incorrectly, resulting in a dangerous situation that could result in injury or death.

Do not begin the installation of this kit until you read and understand the information contained in this supplement, as well as the OEM information provided by the manufacturer of the combine/header.



Safety precautions and warnings are provided in this manual and on the product. If these hazard warnings are not heeded, bodily injury or death could occur to you or to other persons.

HCC cannot anticipate every possible circumstance that might involve a potential hazard. The warnings in this supplement and on the product are, therefore, not all-inclusive. If an installation technique not specifically recommended by HCC is used, you must satisfy yourself that it is safe for you and for others. You should also ensure that the combine or header will not be damaged or be made unsafe by the installation method that you choose.

The information, specifications, and illustrations in this supplement are based on the information that was available at the time this material was written and can change at any time.

Safety Alert Symbols



The safety alert symbol means **Attention! Become Alert! Your Safety is Involved.**

Hazards are identified by the “Safety Alert Symbol” and followed by a signal word such as “DANGER”, “WARNING”, or “CAUTION”.

DANGER

DANGER: Indicates an imminently hazardous situation which, if not avoided, will result in death or serious injury. This signal word is limited to the most extreme situations.

WARNING

WARNING: Indicates a potentially hazardous situation which, if not avoided, could result in death or serious injury.

CAUTION

CAUTION: Indicates a potentially hazardous situation which, if not avoided, may result in minor or moderate injury. It may also be used to alert against unsafe practices.

IMPORTANT NOTICE

Indicates that equipment or property damage can result if instructions are not followed.

Safety Icon Nomenclature

-  Read the manual
-  Eye protection
-  Adequate support
-  Multiple persons required
-  Slipping injury
-  Tripping injury
-  Safety alert symbol
-  Crushing hazard (overhead)
-  Crushing hazard (body)

General Safety

WARNING

 To avoid personal injury or death, carefully read and understand all instructions before attempting to install the Orbit Reel™ kit. Do not operate or work on a machine unless you read and understand the instructions and warnings in this and all other applicable manuals. Contact HCC if any of the instructions provided are unclear or not understood. Proper care is your responsibility. Always follow all State and Federal health and safety laws and/or local regulations.

 To avoid eye injury, always wear protective glasses. Make sure no one can be injured by flying objects or debris when using tools or working on a machine.

 Personal injury can result from slips or falls. DO NOT leave tools or parts laying around the work area, and clean up all spilled fluids immediately.

Contents

General Safety	3
Installation Procedure	4
Reel Removal	4
Track Support and Hardware Removal	5
Track Support Assembly	6
Installing New Track Support Assembly	9
John Deere 900 Series Only	11
Other Than John Deere 900 Series	12
Installing the Reel	13
Attaching Reel Stop Brackets	14
Pitch Adjustment	16
Final Assembly	16
Warranty	17
Basic Parts	18

Installation Procedure

NOTE: The Orbit Reel™ Trac II Kit works **only** with HCC tube type reels, which were built since 1990.

Reel Removal

There are two types of Orbit Reel™ Kits: single eccentric and double eccentric. On a single eccentric reel, only the end with the tine pitch adjustment will require removal of the existing end shield and installation of the track support assembly. On a double eccentric reel, both ends of the reel will require removal of the existing end shields and installation of two track support assemblies.

⚠ DANGER



Before starting the removal procedure, make sure the reel is adequately supported using an overhead lifting device or a material handling device (forklift). Follow all OEM safety recommendations when removing the reel. Reels can weigh between 500 and 1000 pounds and will result in serious injury or death if not adequately supported during removal.

1. Remove the reel from the header using OEM instructions. This may include removing divider points (1).

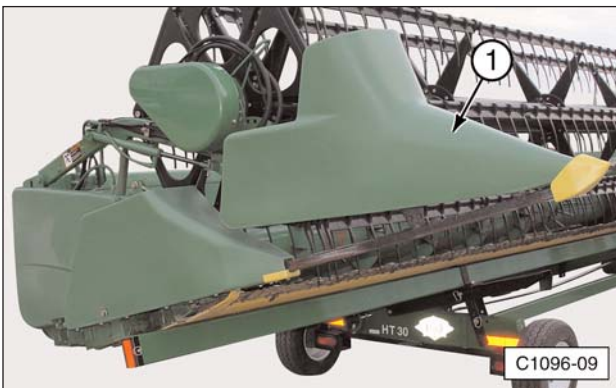

(1) Divider Points.

2. Disconnect hydraulic hoses (3), remove electrical connections such as reel speed sensors (2), remove linkages from cylinder rod connections (6), and/or remove stop plates (5).

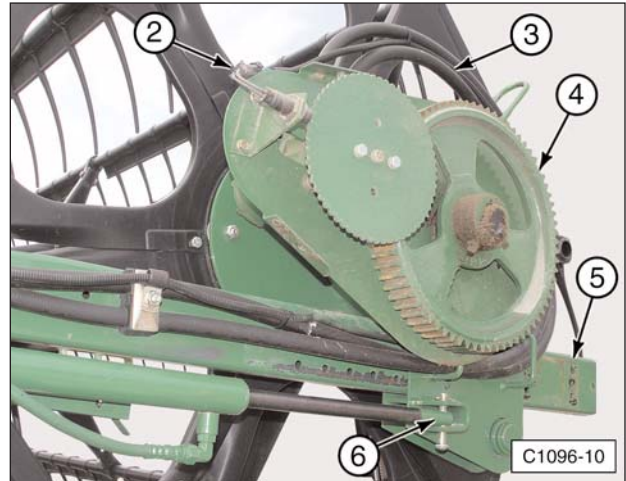

(2) Reel Speed Sensor. (3) Hydraulic Hoses. (4) Drive Gear or Pulley. (5) Stop Plate. (6) Cylinder Rod Connections.

IMPORTANT NOTICE

Plug or cap the hydraulic connections of the hoses and/or motor to prevent contamination of the hydraulic system.



NOTE: Mark the location of each hydraulic hose before removing. This will ensure the proper rotation of the reel when the hoses are reinstalled.

3. Securely attach a lifting device to the reel.
4. Remove the reel from the header reel arms.
5. Place the reel on support stands capable of holding at least 1000 lbs. each.

⚠ DANGER



Inadequate support stands could collapse, causing serious injury or death. Always use support stands rated for the load to be supported.

NOTE: On John Deere 900 series headers, the end shield with drive motor can be removed as a unit after completing Step 3.



C1096-14

Track Support and Hardware Removal

1. Remove the tine pitch adjustment bolt and nut that fastens the reel attaching bracket to the end shield.

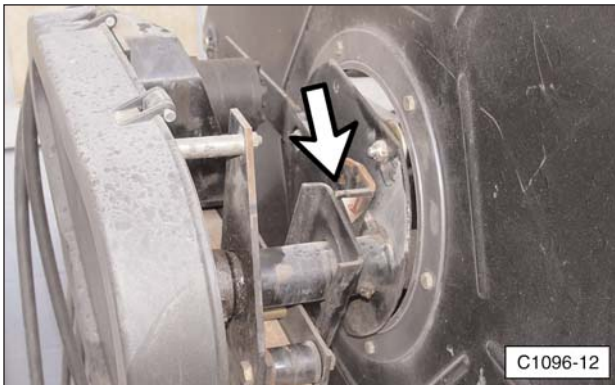

C1096-12

NOTE: The pictures show a typical reel and may not reflect the actual reel being worked on.

2. Remove the reel attaching bracket from the end shaft.

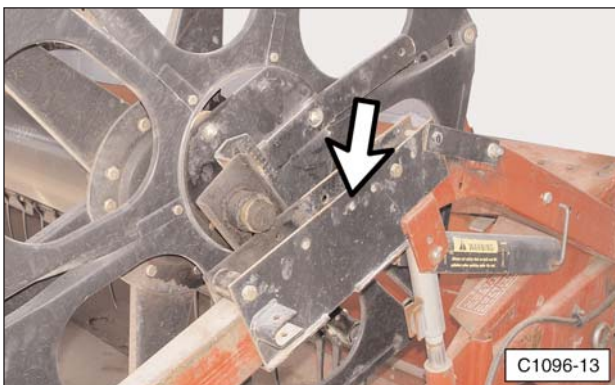

C1096-13

3. Using an 8 mm Allen wrench and a 19 mm wrench, remove all six shoulder bolts and nuts that fasten the end shield to the tine tube bracket(s). This hardware will not be reused.



Tools: 8 mm Allen wrench
19 mm wrench



C1096-15

- On double eccentric reels, remove the reel attachment bracket and end shield from the opposite end of the reel.

CAUTION



The end shield and bracket assembly are heavy and can cause bodily injury, if not removed properly. Use an overhead lifting device or two people to remove the end shield.



C1096-16

NOTE: When removing the end shield from the end of the reel, be careful not to lose the thrust washer(s) (quantities may vary per reel size). These thrust washers must be saved and installed with the new eccentric track support for proper operation of the reel.

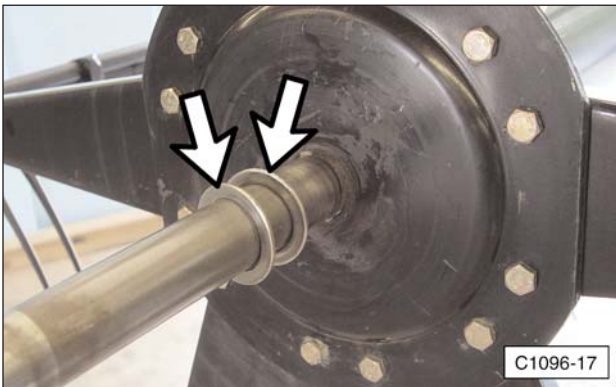

C1096-17

- Some components of the drive-end may be reused with the new Orbit Reel™ bracket. Make sure to note the location and position of all components before removing them.

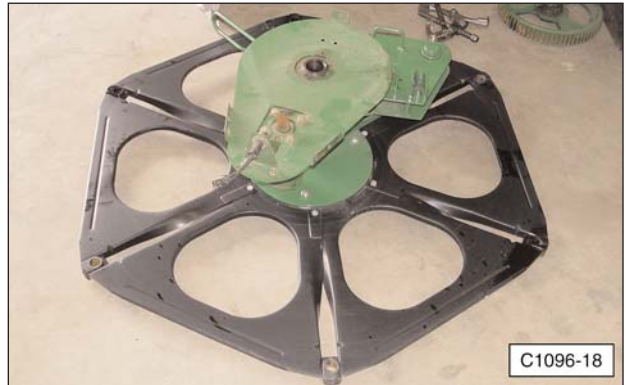

C1096-18

Track Support Assembly

Assemble the new track support(s) with the roller tracks.

- Remove the track support components from the shipping container.

NOTE: Double eccentric kits have both left-hand (1) and right-hand (2) track supports. For more information on track supports, refer to the drawing at the end of this manual.

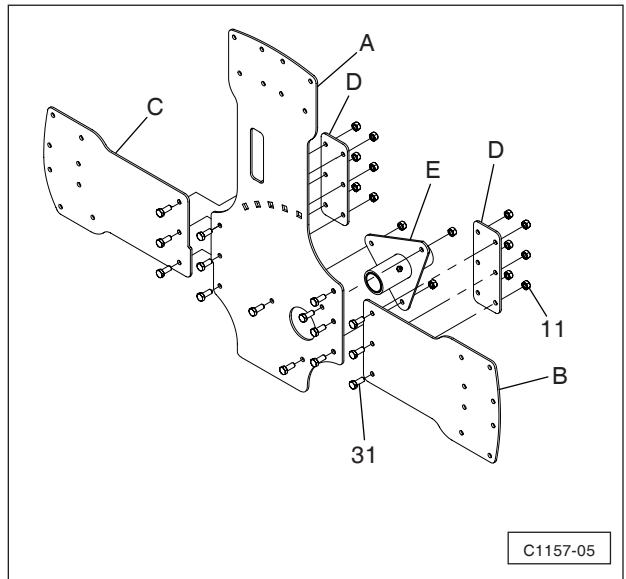

C1157-05

(A) Main Section. (B) Front Section. (C) Rear Section. (D) Connecting Plate (Qty 2). (E) Hub Assembly. (11) M10 Locknut (Qty 15). (31) M10 x 25 Bolts (Qty 15).

NOTE: Hub assembly (E) bolt holes only align when the hub is in the correct position on main track support section (A).

- Assemble either left-hand (1) or right-hand (2) track support using fifteen M10 x 25 bolts (31) and M10 locknuts (11).

NOTE: Hub assembly (E) and connecting plates (D) must be installed on the inside of track supports (1, 2).



Tools: 17 mm socket and ratchet
17 mm wrench

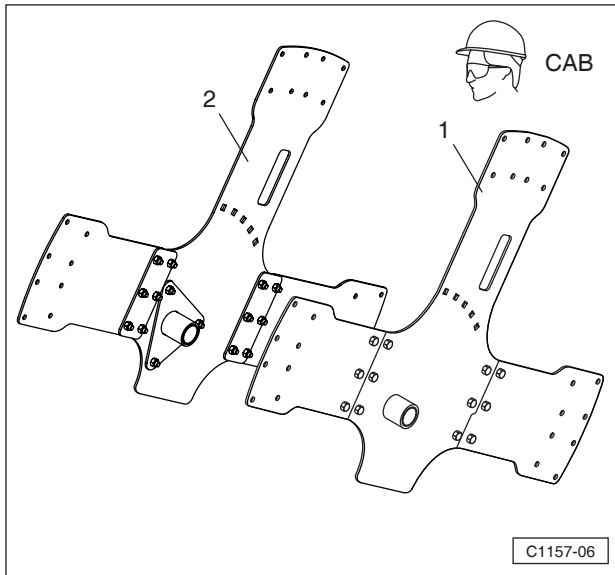

(1) Left-Hand Track Support Assembly. (2) Right-Hand Track Support Assembly.

NOTE: Assembly and installation of left-hand (1) and/or right-hand (2) track support assemblies is based on point of view as seen from the operators cab.

- Tighten all locknuts securely.
- Place a track support on a stand or bench with connecting plates (D) facing up.

NOTE: The roller track must be assembled on the same side of track support (1, 2) as connecting plates (D) and hub flange (E).

- Remove composite inner and outer roller tracks (3, 4) from the shipping container. Also, remove steel action-section inner and outer roller tracks (5, 6, 7, 8).

NOTE: Single eccentric kits contain either right-hand or left-hand parts, depending on the header model.

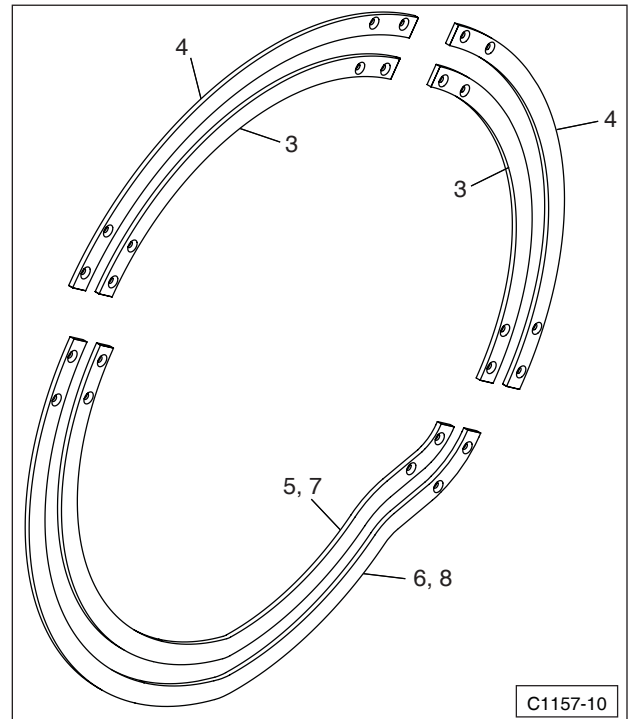

(3, 4) Composite Roller Track.
(5, 7) Left-Hand and Right-Hand Inner Steel Roller Track.
(6, 8) Left-Hand and Right-Hand Outer Steel Roller Track.

- Remove 24 long flathead socket cap screws M10 x 45 (9), 24 spacers (10), and 24 locknuts (11) from the 784031 Hardware Kit bag. Double eccentric kits have two of the 784031 Hardware Kit bags.

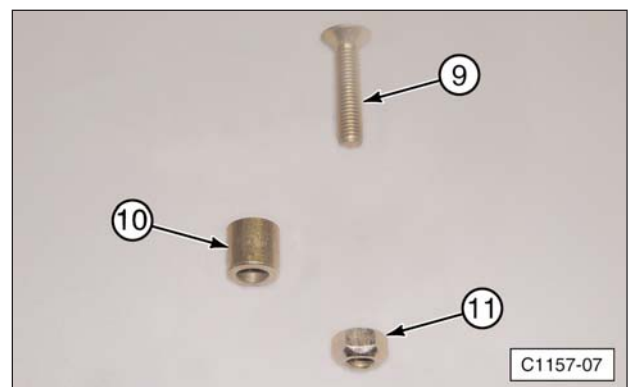

(9) Long Flathead Socket Cap Screws. (10) Spacers.
(11) Locknuts.

- Place two sets of composite inner and outer roller tracks (3, 4) on main support section (1, 2). Make sure countersink holes in the roller tracks are facing upward.
- Assemble the composite roller tracks to the track support using flathead socket cap screws (9), spacers (10), and locknuts (11). The tracks are designed so they can only be installed in the correct location. If the bolt holes do not align, reposition the roller track until the holes align. Loosely tighten the locknuts.



Tools: 6 mm Allen wrench
17 mm socket and ratchet

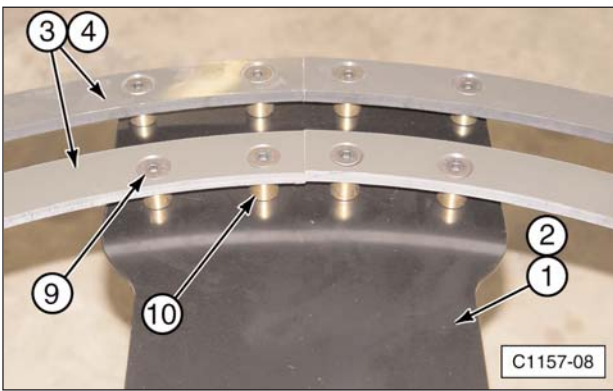

(1, 2) Track Support. (3, 4) Composite Roller Track.
(9) Flathead Socket Cap Screws. (10) Spacers.

- Install the appropriate left or right-hand steel outer action-section roller track (6, 8) to the track support using flathead socket cap screws (9), spacers (10), and locknuts (11).



Tools: 6 mm Allen wrench
17 mm socket and ratchet

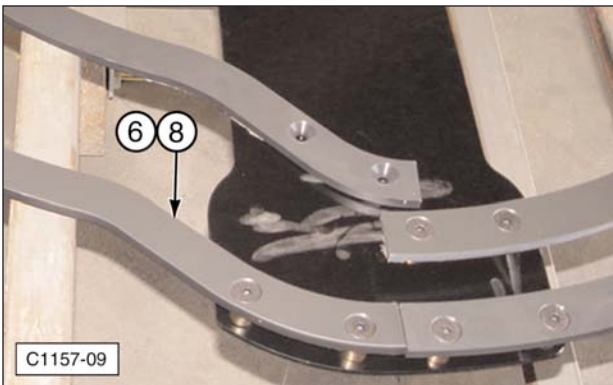

(6, 8) Left-Hand or Right-Hand Outer Action-Section.

- Install six ball bearing rollers (12) into the roller track, as shown.



(12) Ball Bearing Roller.

- Install the remaining inner action-section roller track (5, 7) onto the track support.

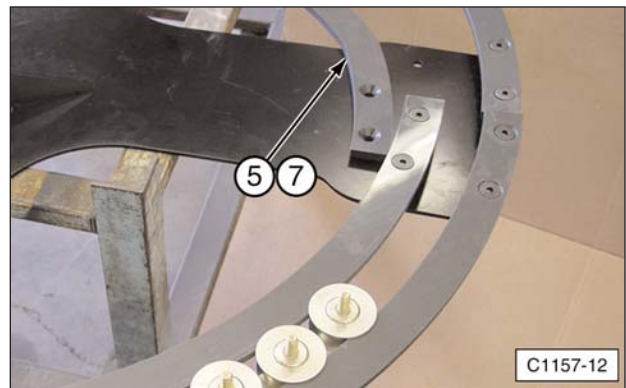

(5, 7) Left-Hand or Right-Hand Inner Action-Section.

12. Completely tighten all locknuts (11) holding the roller tracks to track support (1, 2).



Tools: 6 mm Allen wrench
17 mm socket and ratchet



IMPORTANT NOTICE

Do not overtighten locknuts (11). Overtightening may cause the roller tracks to deform.

13. Make sure rollers (12) slide easily through the roller track. If rollers do not slide easily through the roller track, make sure the locknuts on the flathead socket cap screws are not overtightened.
14. On double eccentric kits, follow Steps 6 through 13 to assemble the other track support and roller tracks.

Installing New Track Support Assembly

1. Make sure original thrust washer(s) on the end shaft are reinstalled.

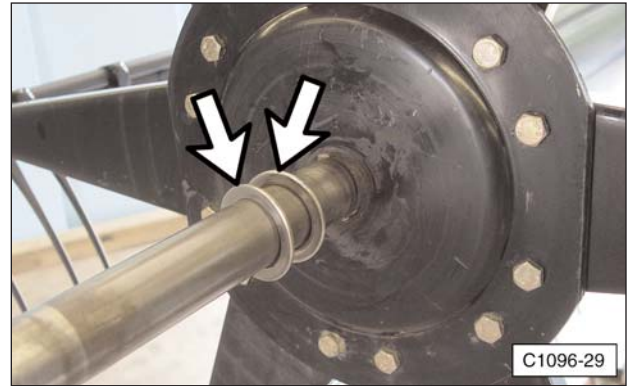

2. Install the drive end track support onto the end shaft.

NOTE: On double eccentric reels, make sure the right and left-hand track support assemblies are installed onto the proper ends of the reel.



- Attach rollers (12) on the tine tube crank arms using locknuts (11). Tighten securely.



Tools: 8 mm Allen Wrench
17 mm socket and ratchet

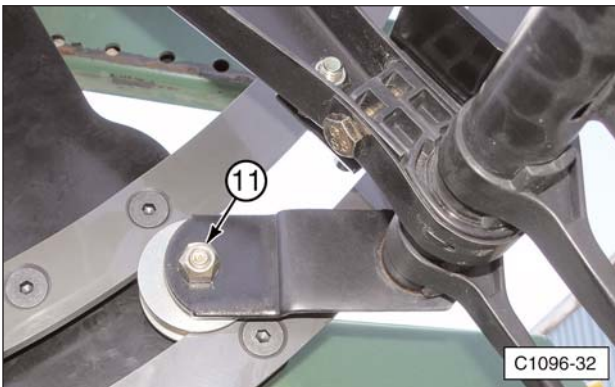
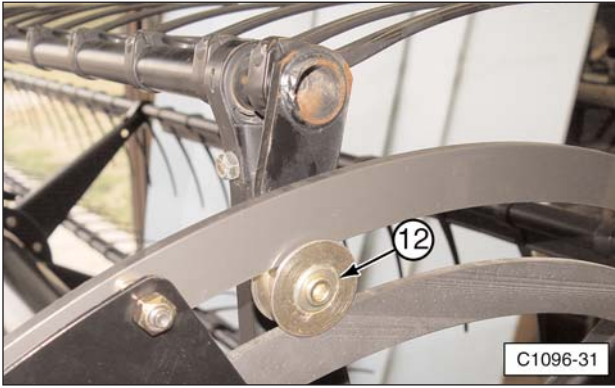

(11) Locknut. (12) Ball Bearing Roller.

- Attach remaining five rollers (12) onto the tine tube crank arms.

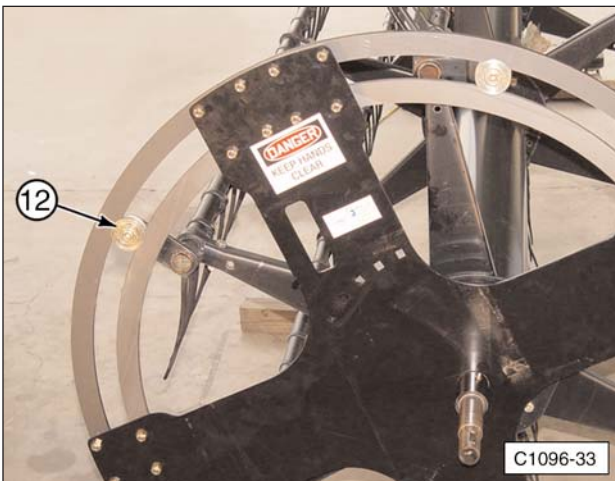

(12) Ball Bearing Roller.

NOTE: On double eccentric reels, attach the rollers to the tine tube crank arms in the same way on the other end of the reel.

- Remove the reel attaching bracket(s) from the shipping container. If the kit contains two brackets, identify the right and left-hand ends.

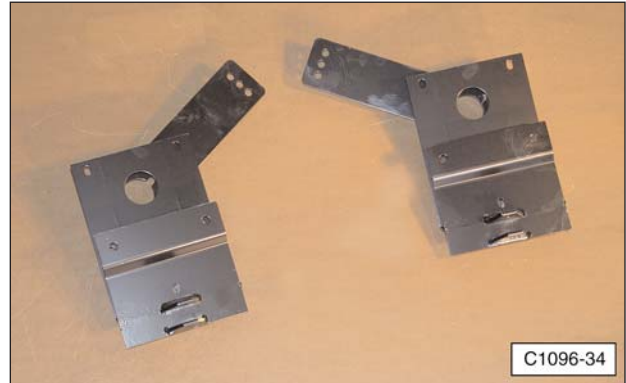

Typical Reel Attaching Brackets.

- Remove the reel support roller hardware, which includes bolt (13), tubing spacer (14), roller bearing (15), and flanged locknut (16), from the shipping container.

NOTE: Agco 8200 and Honey Bee Orbit brackets do not use rollers. Skip Step 6 and Step 7.

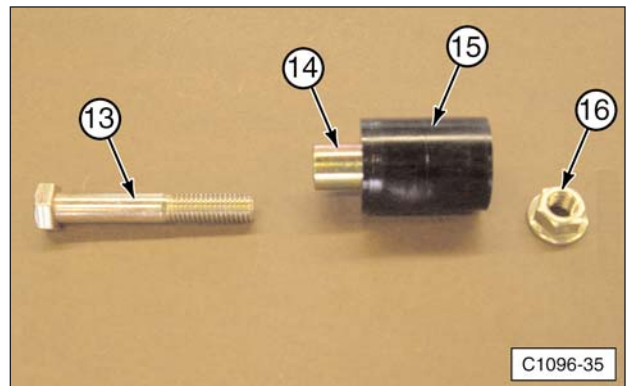

(13) Bolt. (14) Tubing Spacer. (15) Roller Bearing.
(16) Flanged Locknut.

7. Assemble the rollers into the reel attaching bracket(s). For assembly of John Deere 900 series kits, proceed to Step 8. For all other models, go to Step 9.



NOTE: When installing the reel attaching bracket(s), rotate the bracket until the clearance slot in the bracket slides over the grease zerk. One of the hub bolts may need to be removed to fit the bracket over the grease zerk. Reinstall the bolt.

IMPORTANT NOTICE

Failure to follow this step can cause damage to the grease zerk and/or end shaft.

John Deere 900 Series Only

- 8a. Install reel attaching bracket(s) onto end shaft.

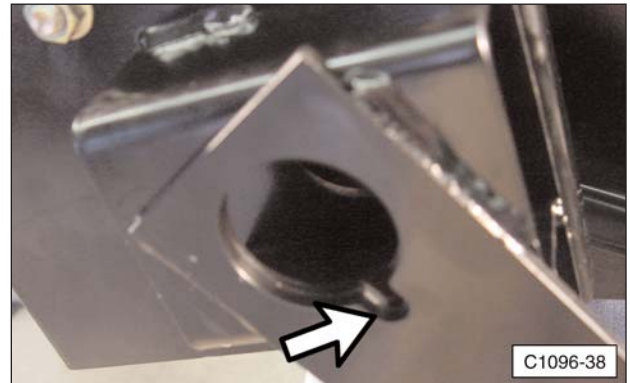
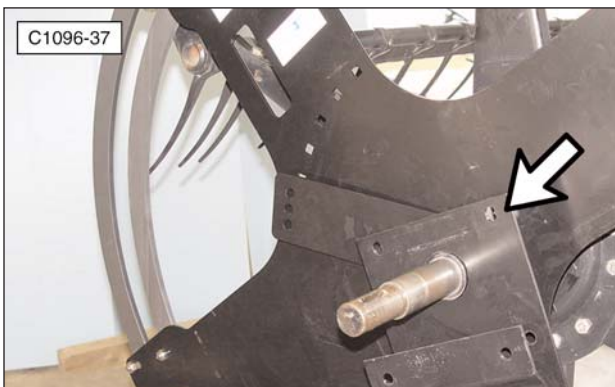

- 8b. On the drive end, slide the drive motor mounting bracket onto the end shaft.



8c. Align the mounting holes and assemble the two brackets using two bolts (17), flatwashers (18), lockwashers (19), and locknuts (20). Loosely tighten the locknuts.



Tools: Two 9/16 inch wrenches

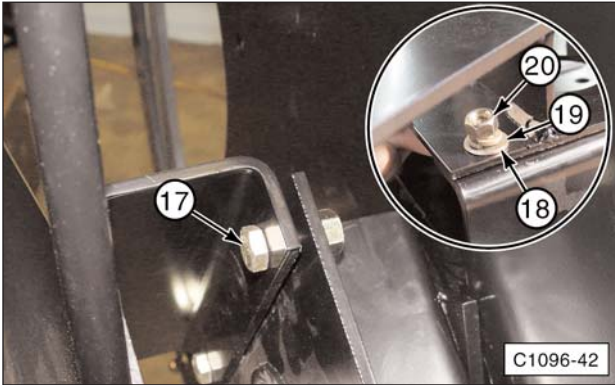

(17) Bolt. (18) Flat washer. (19) Lockwasher. (20) Locknut.

8d. Install two roller bearings (15) and tubing spacers (14) using long bolts (13) and flanged locknuts (16).

NOTE: Long bolts (13) also attach the drive motor mounting bracket to the reel end bracket.



Tools: Two 3/4 inch wrenches

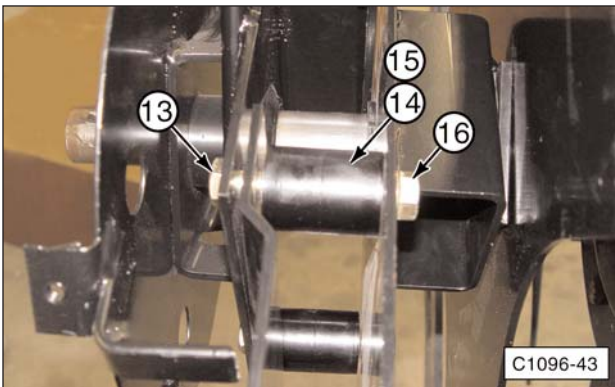

(13) Bolts. (14) Tubing Spacers. (15) Roller Bearings. (16) Flanged Locknuts.

8e. Tighten all four nuts completely.

Other Than John Deere 900 Series

9. Install reel attaching bracket(s) onto end shaft.



NOTE: When installing the reel attaching bracket(s), rotate the bracket until the clearance slot in the bracket slides over the grease zerk. One of the hub bolts may need to be removed to fit the bracket over the grease zerk. Reinstall the bolt.

IMPORTANT NOTICE

Failure to follow this step can cause damage to the grease zerk and/or end shaft.

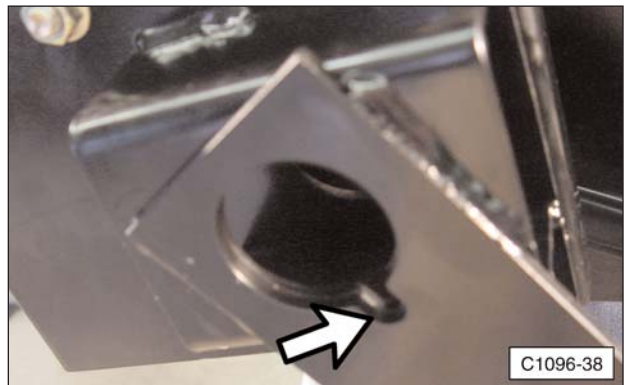

10. Reassemble the drive end components removed from original end shield. Tighten the drive gear or sprocket onto the shaft. Reinstall hydraulic motor and drive gear guards.

NOTE: On some headers, hydraulic hose extensions may be required to provide slack during fore and aft positioning of the reel.

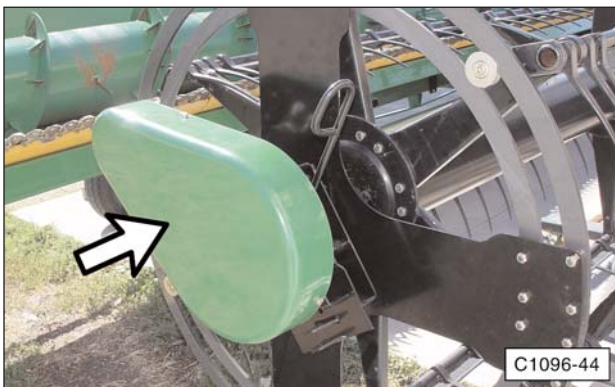

11. On double eccentric kits, install lock ring with two set screws (21) on the non-drive-end of the reel.



(21) Lock ring With Set Screws.

Installing the Reel

⚠ DANGER



The reel assembly is heavy. Follow all OEM safety recommendations when installing the reel. Reels can weigh between 500 and 1000 pounds and will result in serious injury or death if not adequately supported during installation.

1. Lift the reel off the support stands, and install it onto the header reel lift arms.

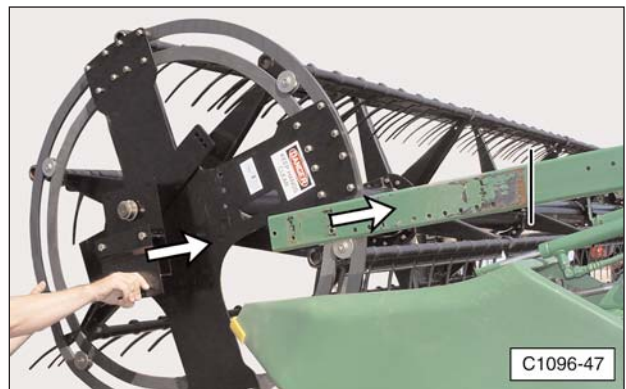

2. Reattach the hydraulic hoses in the proper location. Reattach any cylinder rods. Install the stop plates and any other reel components that were previously removed.

Attaching Reel Stop Brackets

The installation of the Reverse Stop Brackets for the Orbit Reel™ Kit will keep the tines rotating into the crop in the proper orientation. Without the installation of the reverse stop brackets, the tine tubes can rotate, placing the tines in a position that may affect their ability to move the crop into the header.



(11) M10 Locknut (22) Top Reverse Stop Bracket.
 (23) Bottom Reverse Stop Bracket. (24) M10 x 70 Bolt.
 (25) Belleville Washer.

The reverse stop brackets mount above and below the tine tube bearing next to the tine tube crank arms.

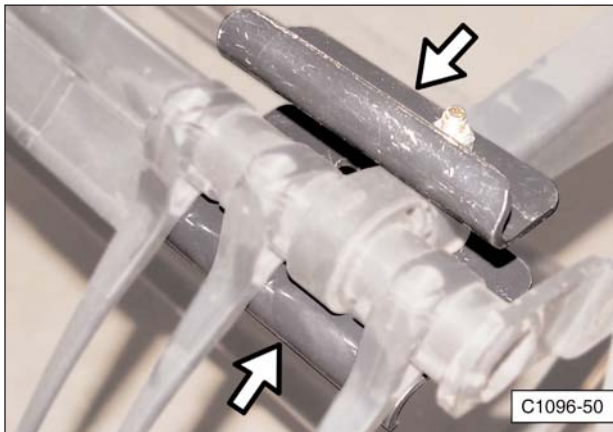

1. Make sure the tine tube is correctly oriented, as shown in the photos.

NOTE: To adjust the rotation of the tine tube roller bracket, rotate the reel to the front of the header (closest to you) until the tine tube bracket and the reel arm are parallel. In this position, the tine tube can be rotated into the correct orientation.

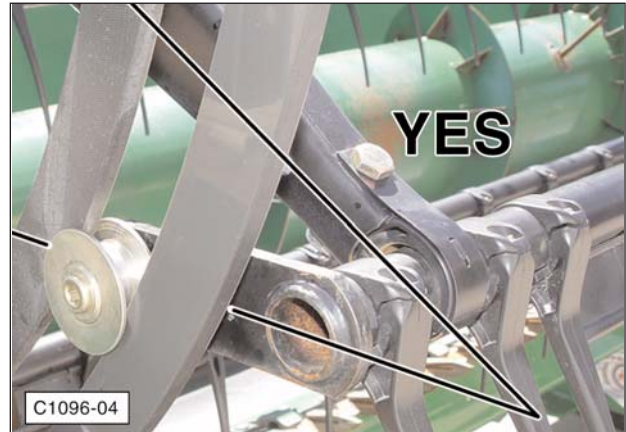

Correct orientation (roller is below or leading tine tube into header).



Incorrect orientation (roller is above or following tine tube into header).

! WARNING



A pinch point exists between the roller and the roller track when rotating the reel. To avoid personal injury, do not place your fingers between the inner and outer roller tracks.

2. Remove the locknut and bolt holding the tine tube bearing onto the reel arm.
Discard the locknut and bolt.



Tools: 17 mm socket and ratchet
17 mm wrench



3. Install the reverse stop brackets.

3a. Insert M10 x 70 mm long bolt (24) through the outermost hole in bottom reverse stop bracket (23). Install belleville washer (25) over the bolt, cupped side down.

3b. Insert bolt (24) up through the tine tube bearing clamp and bearing.

3c. Install top reverse stop bracket (22) on the bolt, and install locknut (11) onto the bolt.

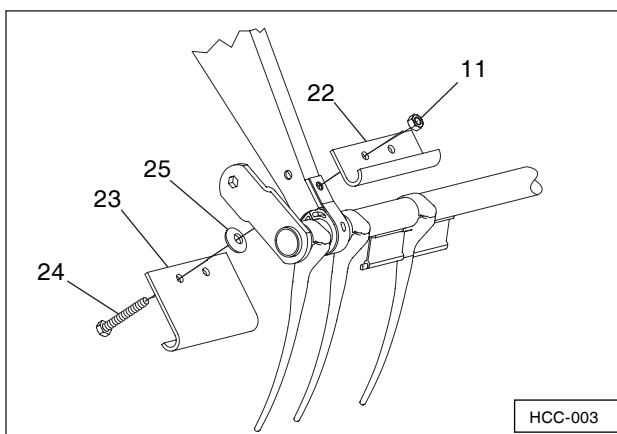

(11) M10 Locknut (22) Top Reverse Stop Bracket.
(23) Bottom Reverse Stop Bracket. (24) M10 x 70 Bolt.
(25) Belleville Washer.

NOTE: Make sure bolt head (24) is positioned on the bottom of the reel arm.

3d. Align top (22) and bottom (23) reverse stop brackets, and securely tighten locknut (11).

NOTE: Overtightening the locknuts can cause damage to the tine tube bearing.



Tools: 17 mm socket and ratchet
17 mm wrench

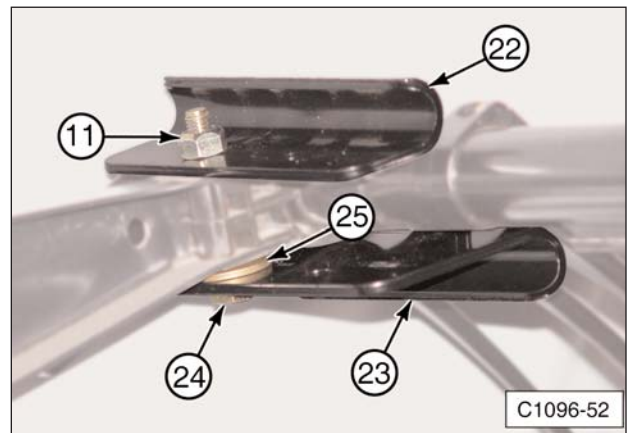

(11) M10 Locknut. (22) Top Reverse Stop Bracket.
(23) Bottom Reverse Stop Bracket. (24) M10 x 70 Bolt.
(25) Belleville Washer.

4. Rotate the next tine tube to the front position, and continue to install the remaining reverse stop brackets; six sets (top and bottom) on single eccentric reels, and twelve sets (top and bottom) on double eccentric reels.

Pitch Adjustment

1. Once all reverse stop brackets are installed, rotate the reel assembly to the point that allows the reel to be positioned closest to the auger. Install carriage bolt (30) in the square hole in track support (1, 2) that aligns with one of the round holes in the end shaft bracket (28, 29), as shown.
2. Install belleville washer (25) and nut (32).
3. Completely tighten nut (32).



Tools: 17 mm socket and ratchet
17 mm wrench

NOTE: Make sure the taper of the washer is facing outward and the nut is installed on the outboard side of the reel assembly, as shown.

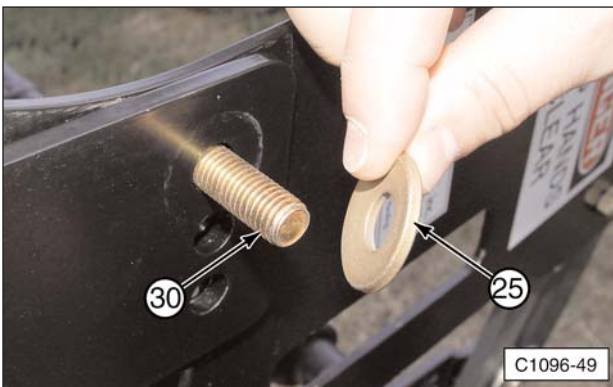
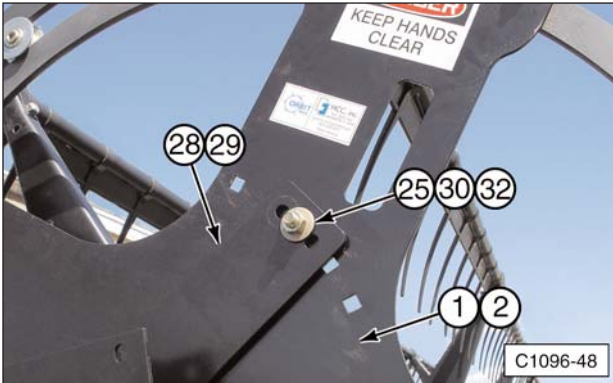

(1, 2) Track Support. (28, 29) End Shaft Bracket.
(30) Carriage Bolt. (25) Belleville Washer. (32) Nut.

Final Assembly

1. Install the divider points, if necessary.
2. Set the pitch adjustment [end plate bracket (28, 29)] to suit crop conditions.
3. Grease both ends of the reel shaft.
4. Adjust the cutter-bar-to-tine distance, as per manufacturer's recommendation.

IMPORTANT NOTICE

Failure to make proper adjustments could result in cutting off the tips of the plastic tine fingers.

5. Check and adjust the reel fore/aft position as per manufacturer's recommendation.

IMPORTANT NOTICE

Failure to make proper adjustments could result in the reel contacting the auger, causing damage to the Orbit Reel™ support and track sections.

Basic Parts

All quantities, shown in the Common Parts chart, are for a single eccentric reel.

The following parts are common to all Orbit Reel™ Trac II Kits.

Refer to the next page for an illustration of the listed parts.

Common Parts			
Orbit Track Support Sections			
A	784281	Main Support Section (1 or 2) ¹	1
B	483310	Front Support Section	1
C	483311	Rear Support Section	1
D	483312	Connecting Plate	2
E	—	Hub Assembly	1
Orbit Roller Tracks			
3	483238	Inner Section (Composite Roller Track)	2
4	483239	Outer Section (Composite Roller Track)	2
5	483470	RH Inner Action-Section ² (Steel Roller Track)	1
6	483471	RH Outer Action-Section ² (Steel Roller Track)	1
7	483468	LH Inner Action-Section ² (Steel Roller Track)	1
8	483469	LH Outer Action-Section ² (Steel Roller Track)	1
lock ring			
21	—	Lock Ring and Setscrews ³	1
End Brackets⁴			
28	—	RH End Bracket	1
29	—	LH End Bracket	1
Hardware Kit			
—	784031 ⁵	Double Eccentric	2
		Single Eccentric	1

¹ Make either one left-hand (1) or one right-hand (2) track support.

² Single eccentric kits only have a right or left-hand part.

³ If Required.

⁴ Not Shown.

⁵ See Hardware Kit chart for list of parts contained in the 784031 hardware package.

784031 Hardware Kit			
Orbit Roller Track Mounting Hardware			
9	206071	Flathead Socket Cap Screw (M10 X 45)	24
10	483275	Spacer	24
11	212412	Locknut (M10)	24
Orbit Roller Hardware			
11	212412	Locknut (M10)	6
12	243719	Ball Bearing Roller	6
Orbit Track Support Section Hardware			
11	212412	Locknut (M10)	15
31	202807	Hex Head Bolt (M10 X 25)	15
Reverse Stop Bracket Hardware			
11	212412	Locknut (M10)	6
22	483301	Top Reverse Stop Bracket	6
23	483302	Bottom Reverse Stop Bracket	6
24	202814	Bolt (M10 X 70)	6
25	214244	Belleville Washer (M12)	6

Miscellaneous Hardware			
Roller Mounting Hardware			
13	—	Hex Head Bolt	2
14	481497	Tubing Spacer (.75" X 2.06")	2
15	243686	Reel Support Roller	2
16	—	Prevailing Torque Hex Flange Locknut	2
End Bracket Mounting Hardware⁶			
17	202190	Hex Head Bolt ⁷ (3/8-16 X 1.0")	2
18	214270	Flat Washer ⁷ (3/8")	2
19	214130	Helical Spring Lockwasher ⁷ (3/8")	2
20	212150	Hex Nut ⁷ (3/8-16)	2
Pitch Adjustment Hardware			
25	214244	Belleville Washer (M12)	1
30	201145	Carriage Bolt (M12 X 1.75 X 40)	1
32	212404	Hex Nut (M12 X 1.75)	1

⁶ John Deere 900 Series Only.

⁷ Not Shown.

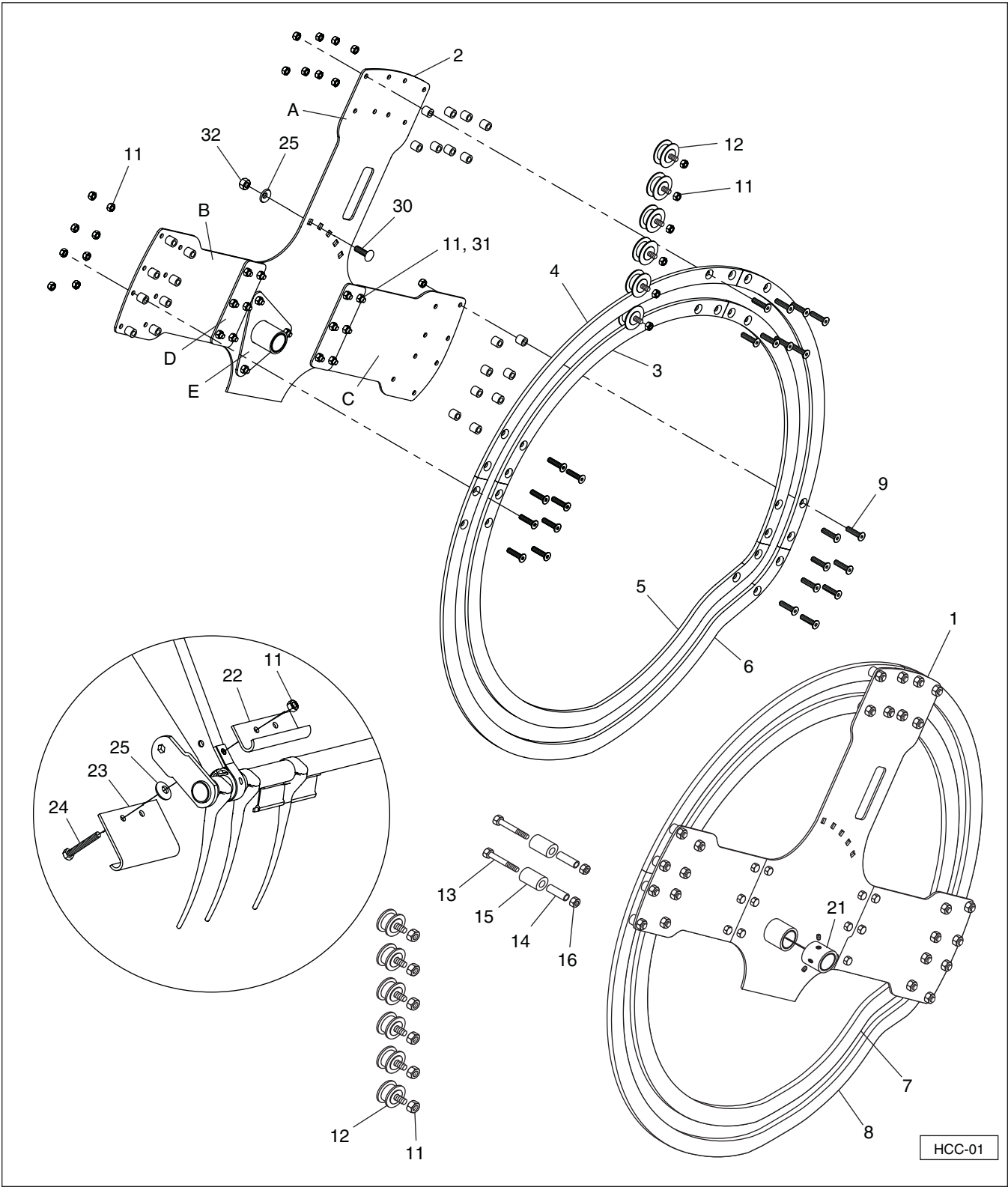

HCC, inc.

1501 1st Avenue – Mendota, Illinois 61342
(815) 539-9371 Fax (815) 539-3135

LIMITED WARRANTY

HCC, inc. warrants each new HCC, inc. product to be free from defects in material and workmanship. This warranty is applicable only for the normal service life expectancy of the product or components, not to exceed 12 consecutive months from the date of delivery of the new HCC, inc. product to the original purchaser.

Genuine HCC, inc. replacement parts and components will be warranted for 90 days from date of purchase, or the remainder of the original equipment warranty period, whichever is longer. There is no warranty for tires.

Under no circumstances will it cover any merchandise or components thereof, which, in the opinion of the company, has been subjected to misuse, unauthorized modifications, alteration, an accident, or if repairs have been made with parts other than those obtainable through HCC, inc.

Our obligation under this warranty shall be limited to repairing or replacing, free of charge to the original purchaser, any part that, in our judgment, shall show evidence of such defect, provided further that such part shall be returned within thirty (30) days from date of failure to HCC, inc., routed through the dealer and distributor from whom the purchase was made, transportation charges prepaid.

This warranty shall not be interpreted to render HCC, inc. liable for injury or damages of any kind or nature to person or property. This warranty does not extend to the loss of crops, loss because of delay in harvesting, or any expense or loss incurred for labor, substitute machinery, rental, or for any other reason.

Except as set forth above, **HCC, inc. shall have no obligation or liability of any kind on account of any of its equipment and shall not be liable for special or consequential damages. HCC, inc. makes no other warranty, expressed or implied, and specifically, HCC, inc. disclaims any implied warranty of merchantability or fitness for a particular purpose. Some states or provinces do not permit limitations or exclusions of implied warranties or incidental or consequential damages, so the limitations or exclusion in this warranty may not apply.**

This warranty is subject to any existing conditions of supply which may directly affect our ability to obtain materials or manufacture replacement parts.

HCC, inc. reserves the right to make improvements in design or changes in specifications at any time, without incurring any obligation to owners of units previously sold.

No one is authorized to alter, modify, or enlarge this warranty nor the exclusion, limitations, and reservations.

Effective with products delivered to original user on or after January 1, 2006

HCC, Inc.
1501 1st Avenue
Mendota, IL 61342
815-539-9371
www.hccincorporated.com

C-1096-04
March 2010