

WEAVERLINE

MULCH MASTER

OPERATORS MANUAL

MODELS KB1300 THRU KB1455
SERIAL NO. 12501 TO PRESENT



WEAVERLINE, LLC
CHURCHTOWN, PA

INTRODUCTION

THANK YOU...

For choosing a Weaverline Mulch Master. A product manufactured in the U.S.A by Weaverline, LLC of Churchtown, Pennsylvania, founded in 1965. When used and maintained properly your investment will provide years of dependable performance.

PURPOSE

The purpose of this manual is to assist the operator in maintaining and safely operating this machine. It must be carefully read and understood before operating or attempting any adjustments.

The photos and illustrations throughout this manual were current at the time of printing, but due to continuous improvement, your machine may vary slightly. Weaverline, LLC reserves the right to improve, change or modify its equipment, parts or options thereof without any obligation of notification or updating previous machines.

SAFETY

Equipment of this nature can cause severe injury or death if operated incorrectly. Safety should be of primary concern when working around this machine. Common sense and safety go hand in hand – USE IT!



THIS SYMBOL IS USED TO CALL OUT A WARNING OR DANGER.

DEATH, PERSONAL INJURY, OR PROPERTY DAMAGE MAY OCCUR UNLESS INSTRUCTIONS ARE FOLLOWED CAREFULLY.



WARNING:

If after reading this manual you fail to understand any part of this manual, how to operate this piece of equipment, or do not understand any other information included with this manual call Weaverline, LLC before proceeding.

Call between the hours of 7:00 am and 5:00 pm EST at one of the following numbers:

Phone: 877-464-1025
717-445-6724



WARNING:

Included with this manual are additional manuals or materials that cover options or components included with the equipment described in this manual. In addition to this manual these materials should be read and understood completely before operating or servicing this equipment.

SERIAL NUMBER

The serial number is located on the gearbox plate (see Figure 1.) This is an aluminum tag with a green background. **REMOVAL OF OR TAMPERING WITH THIS TAG CAN VOID WARRANTY!**



Figure 1 Serial Number Tag Location

WEAVERLINE, LLC	
Model No.	<input type="text"/>
Serial No.	<input type="text"/>
CHURCHTOWN, PA 17555-9705	

Always refer to these numbers when ordering options, parts, service or information. Enter this information below for speedy reference.

MODEL NUMBER _____

SERIAL NUMBER _____

TABLE OF CONTENTS

SAFETY	2
OPERATION and CONTROLS	2-3
SERVICE	4-5
Adjustments	5
SPECIFICATIONS	5
PARTS EXPLOSION DIAGRAMS and LISTS	6-7

SAFETY



WARNING:

This machine is to be operated only by adults. Read and understand this operator's manual completely before attempting to operate, service or make adjustments. Prior to use, locate all warning decals and be aware of the safety hazards they call out.



WARNING:

Never wear loose clothing while operating this equipment, it can become caught in moving parts.



WARNING:

Using materials other than those listed may result in personal injury or damage to the machine.



WARNING:

Hydraulic fluid escaping under pressure can penetrate the skin. Hydraulic fluid may also infect a minor cut or opening in the skin. If injured by escaping fluid, seek medical attention immediately. Relieve all pressure before disconnecting lines or servicing.

Your WEAVERLINE CHOPPER or MULCHER is designed to process only certain materials. We suggest only the following dry materials to be processed:

- Straw
- Prairie Grass
- Compressed hay
- Marsh Hay
- Hay
- Grass
- Leaves
- Paper*
- Cardboard*

* Only when equipped with 76 knives.

Note: If bales are bound by wire instead of string or plastic, remove wire before placing the bales into the hopper.

PRE-OPERATION SAFETY CHECK

AGAIN, be sure to read this manual completely before operating or servicing this piece of equipment!

Keep all shields in place and carefully follow decal instructions.

Make sure all electrical connections are secure and in good condition. High voltage arcing can KILL.

Make sure all controls operate correctly.

Be sure that fire extinguisher is in place and fully charged.

Check hopper for foreign objects before applying power.

Keep others away. Make sure only the operator is near the machine during operation.

Make sure all connections are tight and hoses in good condition before applying pressure to the hydraulic system.

After servicing, be sure to remove all tools and loose objects from the machine.

Apply power to rotor and hopper. Check for excessive noise and vibration.

After going through the checklist above and the operator is sure the machine is operating properly, chopping may begin.

OPERATION



CAUTION:

On models equipped with a gas engine the muffler and the exhaust manifold become very hot during operation and remain hot for a period of time after stopping the engine. Be careful not to touch these items while they are hot. To avoid severe burns or fire hazards, let the engine cool before transporting or storing this piece of equipment.



WARNING:

Never operate this piece of equipment without the spout supplied with this machine securely fastened to the blower housing. Never put any part of your body or allow anyone else to put any part of their body in front of either the spout outlet or the hose outlet if so equipped.

CONTROLS

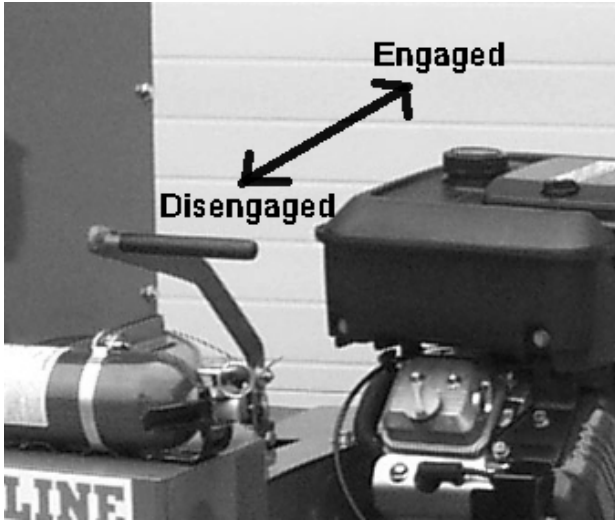

Figure 2 Rotor Clutch Engagement

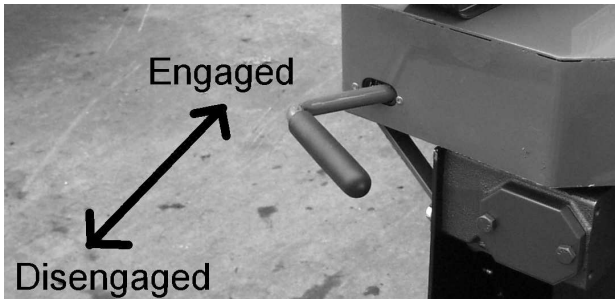

Figure 3 Hopper Rotation Clutch

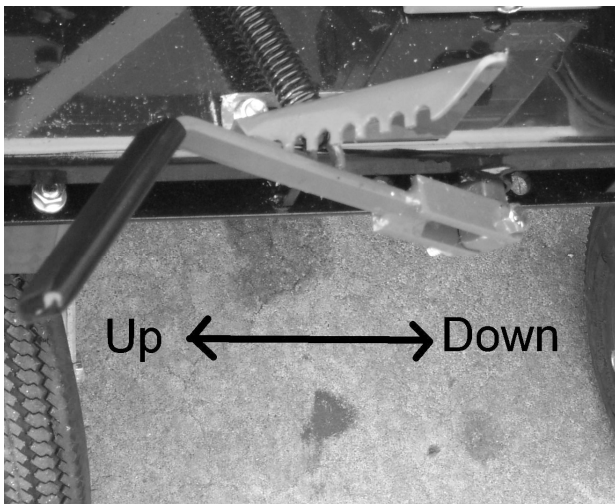

Figure 4 Adjustable Grate

To begin operation:

1. Make sure all hopper and rotor engaging mechanisms are disengaged.
2. Set grate to highest position (Figure 4.)
3. Adjust discharge to desired position.
4. Start the engine on gas powered models.

5. Turn on the electric motor, apply power on the hydraulic unit or engage the rotor clutch on gas powered models (Figure 2.)
6. Place the first bale or other material to be chopped into the hopper.
Note: Cut and remove strings from bale immediately after inserting into hopper. Any sting or wire should be removed from other bundled materials **before** inserting into hopper.
7. Engage the clutch to start the hopper rotating (Figure 3)
8. Lower the grate so that the machine operates smoothly and produces desired length of cut.
Note: Moving the grate lever to the right will lower the grate and moving the lever to the left will raise the grate (Figure 4.)
Adjusting the grate to a lower position decreases cutting time while increasing material length.
9. Continue to add bales (or other material) when the hopper is 1/2 to 2/3 empty.

DURING OPERATION

Always wear approved eye protection.

Do not attempt to remove any material or obstructions from hopper or rotor while machine is running.

Never force materials onto the rotor with your hands, feet or other objects.

Never stand in front of discharge.

Keep hands, feet, and clothing away from moving parts.

Keep all shields and guards in place.

Carefully follow decal instructions (Replace decals when badly worn or difficult to read.)

Do not open any covers or remove any shields while rotor or hopper is rotating (Rotor continues to rotate momentarily after power has been shut off.)

To stop operation:

1. Set grate to highest position.
2. Stop hopper rotation.
3. Slowly reduce engine speed to idle.
4. Disengage rotor and or shut off power supply.

For maintenance purposes and to reduce fire hazard, clean chopped material and debris from machine immediately after each use. On machines equipped with gasoline engines the fuel shut-off valve should be closed between uses.

SERVICE



WARNING:

Lockout power source and be sure all moving parts have come to rest before performing any service work.

CLEANING

Keeping the machine clean is an important part of maintenance and will help to insure proper operation. In addition to general cleaning, the rotor and engine (where applicable) should receive special attention.

ROTOR

An accumulation of materials such as baler twine or string around the rotor can result in poor operation or possibly even rotor or bearing failure. Any such buildup should be checked for and corrected prior to each use and more often if necessary. Burning is **not** a method that should be used to remove materials from the rotor.

GAS ENGINE

Chopping paper, straw, hay or other materials can create large amounts of dust. This makes it necessary to clean the air filtering system more frequently than recommended by the engine manufacturer. It is best to check the filter system prior to each use but at least once a week when using the chopper on a daily basis. Refer to engine manual for cleaning instructions.

Allowing dust and debris to accumulate between cooling fins will cause an increase in operating temperature. As a result engine may suffer a loss of power and increase the possibility of fire. A clean engine will last longer and deliver peak performance.

Follow the engine manufacturer's instructions for additional maintenance procedures.

GEAR BOX

See manufacturer's instructions.

BEARINGS

The bearings are sealed and require no lubrication. Build up of chopped material or other debris should be removed often to aid in preventing premature bearing failure. If you do choose to grease the rotor bearings, you should grease a maximum of one pump of a grease gun once every six months.

ROTOR BLADE REPLACEMENT.

Refer to separate instructions included with this manual.

Adjustments

GRATE STOP ADJUSTMENT

If any knife tips are striking the end rod on the adjustable grate while in its lowest position the stops (two) must be adjusted. There should be a minimum of 1/16" (2 mm) between the grate end rod and all knife tips. (see Figure 5) The stop bolts are located on the back side of the rotor chamber and can be reached from under the machine (Figure 6)

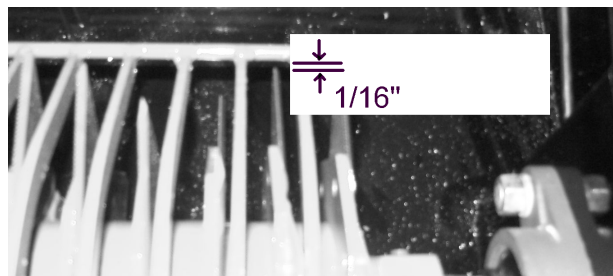

Figure 5 Grate Adjustment

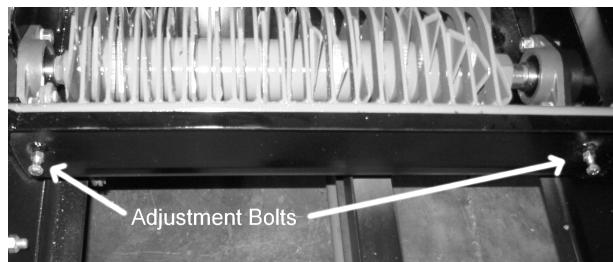

Figure 6 Adjustable Grate Stops

BELT INSTALLATION

V-belts should be installed as shown in figures 7 & 8. All idler pulleys should ride on the flat side of the belt(s). Electric powered models are **not** equipped with a double idler pulley as shown in figure 7.

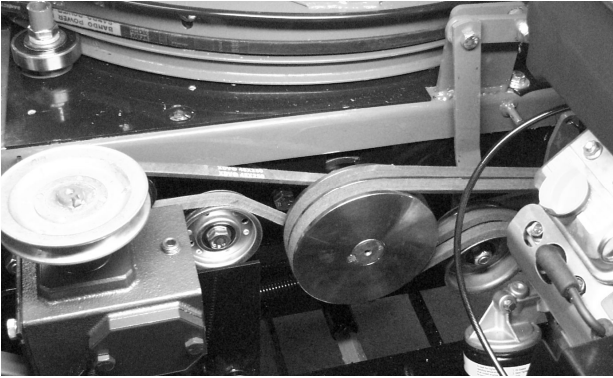

Figure 7 Rotor and Gear Box Drive Belt Installation

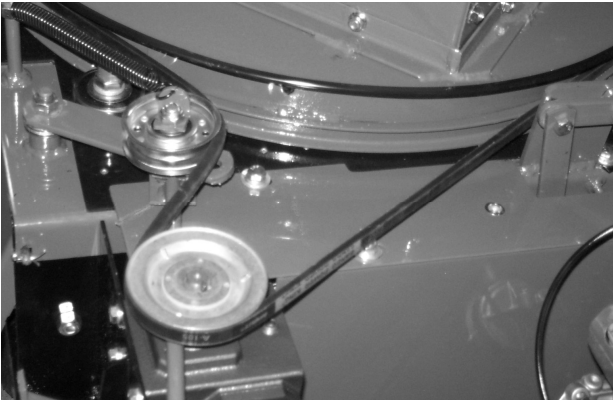

Figure 8 Hopper Belt Installation

BLOWER PADDLE ADJUSTMENT

To adjust the thrower blades inside the blower, remove the blower bottom cover. At the outlet side of the blower housing there should be 1/8" clearance between the end of the thrower blade and the inside of the blower housing as shown in figure 9.

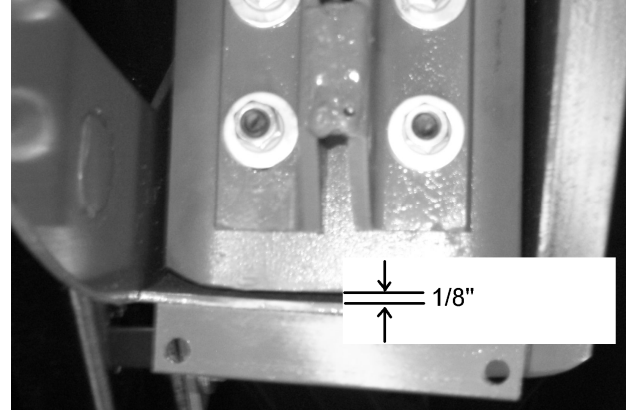

Figure 9 Blower Paddle Adjustment

SPECIFICATIONS

Dimensions:

Length – approximately 56" (1.42m)

Width – approximately 34" (.86m)

Height – 49" (1.24m)

Weight: 650 lbs. (295kg)

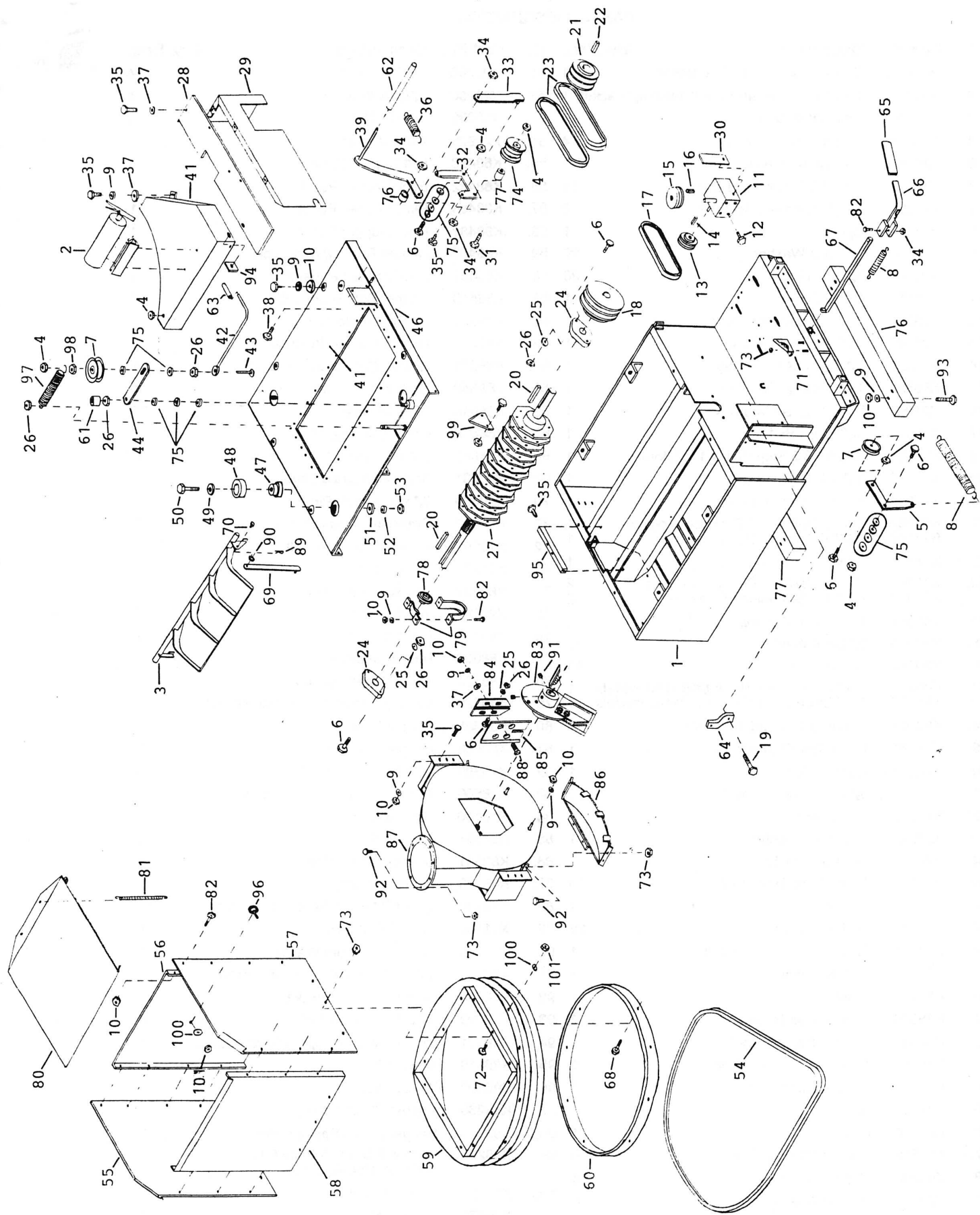

PARTS DESCRIPTION

No.	Part #	Description	Qty Req.	No.	Part #	Description	Qty Req.
1	K88600	Blower Main Frame Weldment	1	51	66-006	5/8" Flat Washer	4
2	K88100	2.5# Fire Extinguisher w/bracket	1	52	66-002	5/8" Lock Washer	4
3	K88625	Adjustable Grate, 4 finger	1	53	66-010	5/8" Hex Nut	4
4	65-019	Lock Nut, 1/2"NC	4	54	X22925	A105 V-Belt	1
5	K88540	Belt Tightner Arm	1	55	K88483	Left Hopper Panel	1
6	65-010	1/2" x 1-1/2" Hex Head Bolt	11	56	K88482	Back Hopper Panel	1
7	K88531	Single Groove Idler Pulley	2	57	K88484	Right Hopper Panel	1
8	K88626	Spring	1	58	K88481	Front Hopper Panel	1
9	64-006	3/8" Lockwasher	26	59	K88480	Hpper Base w/Trim Lok	1
10	64-009	3/8" Hex Nut	28	60	K88487	Plastic Strip F/Paper Kit	1
11	K88580	Gearbox	1	61	K88513	Hopper Belt Guide Tube	1
12	63-012	5/16" x 1" Hex Head Bolt	3	62	K88551	Clutch Handle Grip	1
13	K88583	1B2 Pulley - 1/2" Bore	1	63	K88512	Hopper Clutch Handle Grip	1
14	69-016	Key 1/8" Sqr x 1-1/8"	1	64	K88571	Hopper Belt Guard Support	1
15	K88586	1A4 Pulley - 5/8" Bore	1	65	K88642	Grate Handle Grip	1
16	69-006	Key 3/16" Sq x 1-3/8"	1	66	K88640	Grate Handle	1
17	X22934	6825 V-Belt	1	67	K88634	Grate Adjusting Shaft	1
18	K88262	2B53.5-3.5 Step Pulley 1-1/4" Bore	1	68	X21645	5/16" x 3/4" Truss Head Screv	8
19	63-008	5/16" x 1-1/4" Hex Head Bolt	1	69	K88631	Adjustable Grate Linkage	1
20	69-017	Key 5/16" Sq x 3"	2	70	X20687	3/8" x 3/4" Clevis Pin	1
21	K88260	2B3.5" Pulley - 1" Bore (gas engine)	1	71	K88641	Grate Adjusting Bracket	1
	K88253	2BK130 Pulley - 1-1/8" Bore (electric)	1	72	X19001	5/16" x 1/2" Carriage Bolt	26
22	69-007	1/4" Sq x 1-3/8" Key	1	73	63-010	5/16" Whiz Nut	42
23	X22904	6937 V-Belt (gas engine)	2	74	K88232	Double Groove Idler Pulley	1
	X22902	B37 V-Belt (Electric Powered)	2	75	65-004	1/2" Flat Washer	18
24	K88201	1-1/4" Rotor Bearing	2	76	K88605	Front Skid Block	1
25	65-003	1/2" Lock Washer	10	77	K88606	Rear Skid Block	1
26	65-001	1/2" Hex Nut	15	78	K88528	1-1/4" Hanger Bearing	1
27	K88526	1-1/4" Blower Hex Rotor f/KB1300	1	79	K88529	Bearing Hanger Bracket (2 Pie	1
	K88527	1-1/4" Blower Hex Rotor f/KB1400	1	80	K88485	Hopper Door	1
28	K88562	Lower Belt Guard Top Plate	1	81	K88486	Hopper Door Spring	2
29	K88561	Lower Belt Guard Base	1	82	64-008	3/8" x 1-1/2" Hex Head Bolt	3
30	K88514	Hopper Belt Stop	1	83	K88660	Thrower Hub w/2 Set Screws	1
31	65-011	1/2" x 1-3/4" Hex Head Bolt	1	84	K12100	Thrower Arm	3
32	K88545	Clutch Arm	1	85	K88661	Thrower Blade	3
33	K88547	Clutch Connector Link	1	86	K88651	Blower Bottom Cover	1
34	64-028	3/8" Hex Lock Nut	5	87	K88650	Blower Housing	1
35	64-003	3/8" x 1" Hex Head Bolt	10	88	64-032	3/8" x 1-1/4" Plow Bolt	12
36	K88215	Spring	1	89	61-003	1/8" x 1" Cotter Pin	1
37	64-005	3/8" Flat Washer	26	90	65-004	1/2" Shim Washer	1
38	64-001	3/8" x 1-1/4" Hex Head Bolt	1	91	X20910	5/16" x 3/4" Sq Hd Set Screw	2
39	K88550	Clutch Handle	1	92	X19225	1/2" x 1-1/4" Carr. Bolt	2
40	K88461	Plastic Top	1	93	64-030	3/8" x 4" Carriage Bolt	8
41	K88570	Hopper Belt Guard	1	94	K88571	Plastic Guide f/Hopper Clutch	1
42	K88511	Hopper Clutch Handle	1	95	K88610	Bearing Hanger	1
43	65-028	1/2" x 2-3/4" Carriage Bolt	1	96	63-046	5/16" Eyebolt	1
44	K88510	Hopper Clutch Arm	1	97	K88230	Hopper Clutch Spring	1
45	K88230	Spring	1	98	K88516	Hopper Clutch Spring Catch	1
46	K88460	Cover	1	99	K88205	Knife w/2 Grade 5 Bolts & Nu	56
47	K88209	Hopper Bearing Tube	4			(KB1300 Models Only	
48	K88208	Hopper Bearing	4	100	63-006	5/16" Lock Washer	8
49	66-003	5/8" Flat Washer	4	101	63-007	5/16" Hex Nut	8
50	66-005	5/8" x 2-1/4" Hex Head Bolt	4				