



Forage harvester (Type 498)

JAGUAR  
900 Series



Follow your gut.  
JAGUAR - the chopper.





When you need sophisticated engineering, dependable performance and outstanding results. When your head and your gut are telling you the same thing. Then it's time for the new JAGUAR. With its unique overall concept, a new header drive and a wide range of corncracker rollers including patented SHREDLAGE technology, it will help you safely bring in your harvest with up to 884 hp.

<b>Innovations</b>	<b>4</b>	Intake	42
		V-MAX knife drum	46
<b>Technology in detail</b>	<b>6</b>	New chopping assembly features	48
		Corncracker expertise	50
<b>Comfort cab</b>	<b>8</b>		
CEBIS on-board		<b>Discharge</b>	<b>54</b>
information system	10	Crop accelerator,	
		discharge spout	56
<b>EASY</b>		Discharge spout, AUTO FILL	58
TELEMATICS	12	SILAGE TECH	60
Data management	14	QUANTIMETER dry matter sensor,	
Guidance & steering systems	16	silage additive systems	62
		PREMIUM LINE Parts	64
<b>CLAAS POWER SYSTEMS</b>	<b>18</b>	<b>Headers</b>	<b>66</b>
Engines	20	New PICK UP	68
Cooling	22	DIRECT DISC	70
CRUISE PILOT	24	ORBIS	72
DYNAMIC POWER	26	RU 450	74
Running gear	28		
Hydraulics, electrics	32	PREMIUM LINE ORBIS Parts	76
		Maintenance	78
<b>Chopping system</b>	<b>34</b>	CLAAS Service & Parts	80
Drive	36		
Crop flow, intake	38	<b>Specifications</b>	<b>82</b>
Header drive	40		

# New for 2019.

To meet your needs.

At CLAAS we work every day to make harvesting a little better. We do this with up-to-date machines, with real engineering skill and above all with mud on our boots. Once our machines have finished their work, another field is ready to be cultivated. And the cycle from planting to harvesting begins again.

All our efforts are geared to ensuring that people are able to return from the field at the end of the day with the satisfaction that they have done a good job. And every day we develop new ideas to keep things that way. Some outstanding examples can be found in the new JAGUAR. In this way, we

ensure that it continues to be the most popular forage harvester in the world.

## ALL NEW FOR 2019

- SILAGE TECH technology package
- Comfort cab
- Hydraulic pre-compression
- V-MAX extended
- Weight controller for trailers

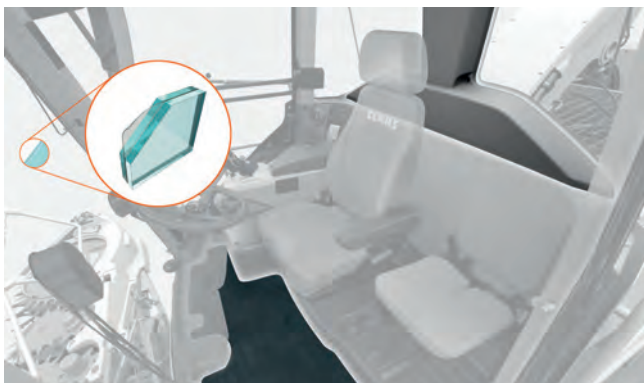

### NEW: Comfort cab options.

Added options like special insulation on the cab rear window, along with thicker and anti-reflective coated glass inside the cab improve noise damping and reduce reflection and glare.

Page 11



### NEW: Hydraulic pre-compression.

The hydraulic damper ensures even distribution of force across the entire pre-compression area.

Page 47



### NEW: Weight counter for trailers.

The new automatic weight counter (standard when adding the QUANTIMETER option) lets the JAGUAR operator control the weights loaded on up to 3 different trailers.

Page 64

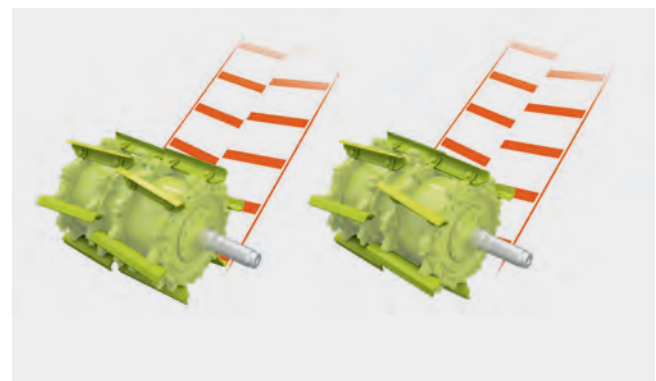

### NEW: V-MAX extended.

The new V-MAX extended knife arrangement offers a more symmetrical distribution of knives for a smoother and more constant crop flow.

Page 49

# SILAGE TECH™ - Silage quality and technology packaged all in one



**NEW: SILAGE TECH.**

SILAGE TECH brings together several components to help you better monitor and optimize your forage harvest.



**QUANTIMETER.**

Continuous volume measurement provides the most accurate yield calculations.



**Automatic chop length.**

Set the length of cut of the crop dependent on moisture to get precise cut length to improve bunk density and consistent particle size.



**NEW: ACTISILER 37.**

The new, larger, insulated inoculant tank maintains optimum temperature of your silage additives and applies precise dosage that can be monitored and controlled in CEBIS.



**Fuel consumption monitoring.**

Provide real-time information to help determine any loss in power due to dull knives or plugged filters.

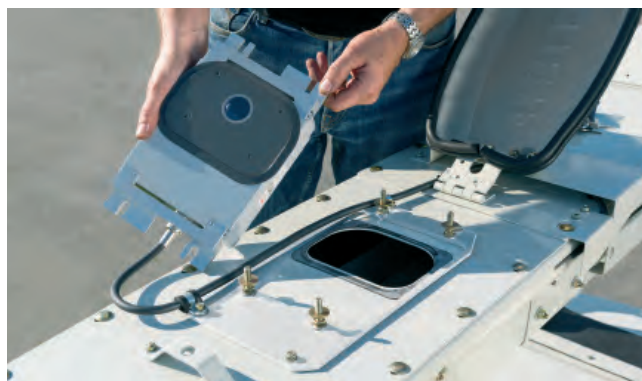

**NIR Sensor.**

Highly accurate moisture sensor to determine the moisture of the crop.

All the highlights.  
At a glance.





- 1 Variable header drive (optional)
- 2 Hydraulic shear bar locking
- 3 Automatic drum concave adjustment
- 4 Differential lock (optional)
- 5 Double hydrostatic motor for ground drive
- 6 Automatic parking brake
- 7 Automatic engine speed reduction
- 8 AUTO FILL rear offloading (optional)
- 9 Functional design
- 10 Outstanding control concept with additional CEBIS features
- 11 LED work lights (optional)
- 12 Corncracker concept: MCC L, MCC SHREDLAGE (optional)
- 13 Engines compliant with Tier 4 final emissions standard
- 14 Tire pressure adjustment system for drive axle and steering axle (optional)
- 15 Modular ballasting concept
- 16 Silage additive metering based on dry matter content (optional); large silage additive tank
- 17 Increased efficiency with DYNAMIC COOLING (optional) and CRUISE PILOT
- 18 DYNAMIC POWER (optional)
- 19 Diesel tank capacity of up to 356 gal (1500 l) for extended working
- 20 Unique accessibility concept for fast and straight-forward maintenance
- 21 Running gear with distinctly small turning radius and large tires
- 22 Easy maintenance through direct knife installation with the integrated positioning gauge
- 23 Throughput-based knife sharpening system
- 24 COMFORT CUT with infinitely variable chop length adjustment
- 25 Continuous precompression, regardless of the material feed height
- 26 QUANTIMETER yield measurement (volume flow measurement-optional)
- 27 Near infrared sensor system for precise determination of dry matter (optional)
- 28 CMOTION multifunction lever (optional)

The JAGUAR workplace.  
Command center with a view.



The benefits at a glance.

- The CLAAS comfort cab: intuitive operation of your JAGUAR
- Wide range of equipment options
- LED work lights: turn night into day





The CLAAS comfort cab.

In the JAGUAR, there is nothing to distract you. The steering column and operator's seat can be adjusted to suit each and every operator. Thanks to the clearly laid-out displays and controls, you will feel right at home in your JAGUAR in no time.



Wide range of in-cab features.

Roller sunblinds, air conditioning, and a new refrigerator under the trainer seat (optional) also help to keep operators fresh and alert, no matter how long they are working.

- Spacious VISTA CAB with three seat options
- Top seating comfort with a choice of the comfort seat, swiveling seat or the heated and ventilated premium seat
- Clear view all-around
- NEW optional refrigerator compartment (required leather trainer seat) to actively chill items
- Optional passive cooling box



LED work lights. (optional)

LED work lights on the cab roof, at the rear and on the discharge spout where they pivot with the crop flow, ensure that nighttime harvesting operations can be monitored very easily.

- Very even illumination
- The white light is similar to daylight

The electronic control center.  
Everything under control and at your fingertips.



### The benefits at a glance.

- CEBIS: the intuitive control hub
- Easily understood symbols
- CMOTION multifunction control lever (optional)
- Rotary switches for easy access to important functions and adjustments

Function	Start chopping	Chopping
Working speed	2000 min <sup>-1</sup>	1850 min <sup>-1</sup>
DYNAMIC POWER main switch	OFF	ON
CRUISE PILOT main switch	OFF	ON
DIRECT STOP main switch	OFF	ON
Crop accelerator	2.0	6.5
Discharge spout main switch	OFF	ON

Loading setting. Press 'ESC' to cancel.

6.9 km/h	4.50 ha
	4.50 ha/h
	48.00 t/ha
	216.00 t/h

**CMOTION multifunction control lever**

- 1 Intake on
- 2 Stop intake and reverse with CMOTION (with variable header drive option)
  - First stage: stop and reverse header
  - Second stage: reverse header and intake
- 3 Discharge spout control
- 4 Header height setting
- 5 Automatic spout swivel
- 6 AUTO FILL / spout park position
- 7 AUTO PILOT

**CEBIS control**

- 8 CEBIS direct menu rotary dial
- 9 CEBIS menu selection rotary dial
- 10 Escape button
- 11 HOTKEY direct menu rotary dial
- 12 HOTKEY menu selection rotary dial/button
- 13 Information button
- 14 DIRECT ACCESS button

**Crop flow**

- 15 Raise/lower discharge spout
- 16 Silage additive system, main switch
- 17 Fold header

**Drive**

- 18 Main drive chopping system on / off
- 19 Gear shift
- 20 Differential lock
- 21 Parking brake
- 22 POWER TRAC all-wheel drive
- 23 Diesel engine speed (three steps)

**CEBIS: the control hub.**

The clear, user-friendly structure of the control system ensures that you can manage the JAGUAR confidently and easily in all conditions. All the main functions are controlled and monitored through just a few central elements. At the heart of this ingenious design is the electronic CEBIS onboard information system, providing a logical and ergonomic interface with every conceivable detail taken into account.

- The CEBIS rotary switch is used to control the basic functions
- The additional HOTKEY direct menu rotary switch allows another important function to be controlled
- All switch functions have logical, self-explanatory icons
- Your hand rests on the multifunction lever where you have instant control over the driving speed, as well as numerous other functions
- Chopping start-up mode for a quick changeover between automatic and manual control



Multifunction control lever



CMOTION multifunction control lever (optional)

# TELEMATICS.

More control, fewer surprises.



## The benefits at a glance.

- Optimize settings
- Improve work processes
- Simplify documentation
- Stay mobile with the app
- Analyze machine performance
- View yield and moisture maps

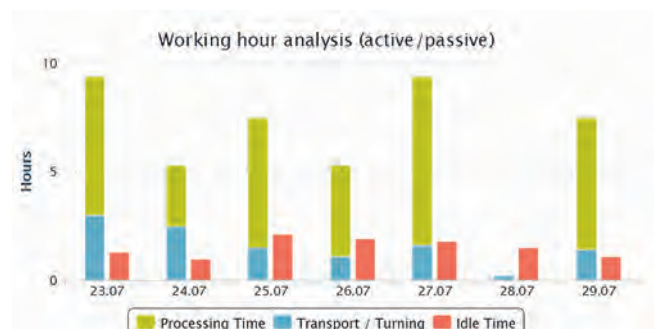

Analysis tools

## A complete overview with just a click of the mouse.

With TELEMATICS, CLAAS lets you retrieve all of your important machine data via the internet, anytime, anywhere – so why not benefit from TELEMATICS yourself?

## Optimize your settings.

Use your personal access to the TELEMATICS web server to compare the performance and harvesting data for your forage harvesters so that you can fine tune the settings for the best results under all conditions every day.

## Improve work processes.

A report detailing the operating hours analysis and other important analysis is sent to you daily by email. This enables you to analyze the precise data from the previous day before starting work, and to determine when and how efficiently your machine has been operating. Additionally, machine movement data based on vehicle tracks can be retrieved with the event log, enhancing transport logistics. TELEMATICS facilitates systematic fleet management and avoids unprofitable downtime.

## Top of the line package.

TELEMATICS Professional one year license is standard on new JAGUAR forage harvesters. A TELEMATICS Professional three year license is also offered as an option. The professional package delivers all of the harvester's data to be viewed, analyzed, and reported on.

## Simplify documentation.

With TELEMATICS, you can export relevant data to your field catalog, saving valuable time. For example, you can import data regarding harvest quantities for specific parts of the fields.

## Stay mobile with the app.

TELEMATICS users can utilize their smartphone to keep tabs on the harvester or tractor in one simple, user-friendly app. A simplified version of the powerful TELEMATICS website is accessible in a convenient mobile app form (available for iOS and Android-based systems) as a free download. TELEMATICS customers can open the app to find current machine data, such as yield, throughput, operating status, fuel level, machine settings, alarm messages, location, and analytics tools to drive decision making.

## View yield and moisture maps.

When you are in the heat of harvest and you do not have time to pull your agronomic data off the third-party monitor for viewing, TELEMATICS offers a simple map functionality where you can view a yield or moisture map overlay on the TELEMATICS website. The timeliness of having this information readily available allows you to get a first impression of your field's performance until you have time to manually move your data at a later date.

Data management.  
Modular and of immediate use.



CEBIS. Evaluate and make use of current data.

You can prepare customer data in CEBIS before running and processing them with CEBIS.

The benefits at a glance.

- CEBIS: benefit immediately from current data.
- Job management in multiple stages

- All the data are backed up when a specific job is completed or the working day comes to an end
- The data can be printed out (optional) or transferred by data card for job processing
- With TELEMATICS, the data can also be accessed online with a PC and can be reused, e.g. for customer invoicing



## Data management.

### 1. Job Management Standard

It is possible to create a collection of 20 jobs in CEBIS. As a result, all the relevant data are available to you at all times and you also have the option of printing them out.

### 2. Third party yield mapping

Building on the foundation of the job management function, you can use your JAGUAR to perform yield mapping. The QUANTIMETER and the moisture measurement allow you to determine the yield. At the same time, third party GPS options like Trimble, Ag Leader, and Field View add geographical coordinates obtained from GPS satellites. All the measured data is stored through the third party. (The Ag Leader SMS or Trimble Farm Works software enables you to produce informative yield maps to use as a basis for your future production strategy.)

Trimble Ag Software

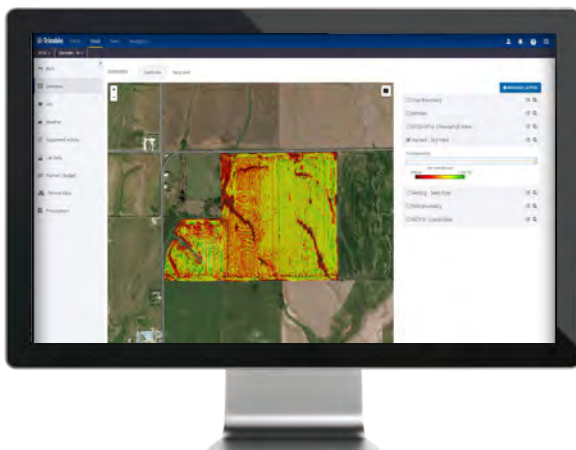

Ag Leader Software

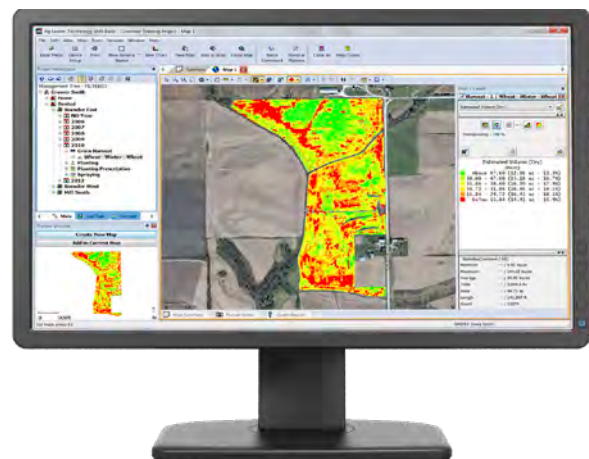

# Guidance and steering systems. (optional) Precisely the help you need.



## The benefits at a glance.

- CAM PILOT: the JAGUAR is guided by the windrow
- AUTO PILOT: automatic guidance based on rows
- Third-party systems: Ag Leader and Trimble

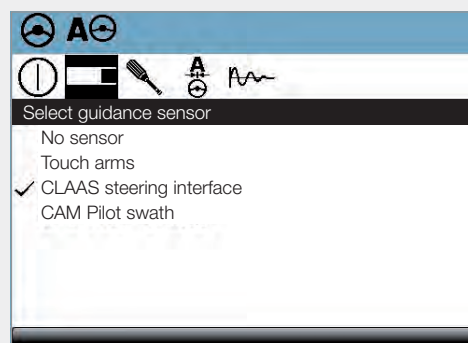





### Seeing with CAM PILOT.

The CAM PILOT assumes the steering of the JAGUAR in combination with the PICK UP. The windrow is detected in three dimensions from a camera with two lenses. Accordingly, signals are transmitted in differential form and direction to the steering. The steering axle is responsive to the steering commands.



### Sensing with AUTO PILOT.

Two sensor wands each gauge two rows of corn. The signals generated by these sensors are translated into appropriate steering impulses. The JAGUAR steering is automatic up to a speed of 7.5 mph (12 km/h).



### Trimble®

The CLAAS open architecture structure via the CLAAS CANBUS allows Trimble GPS steering and Yield Monitoring components to plug and play directly into the JAGUAR. The TMX-2050® offers a full-featured display for your harvesting needs.

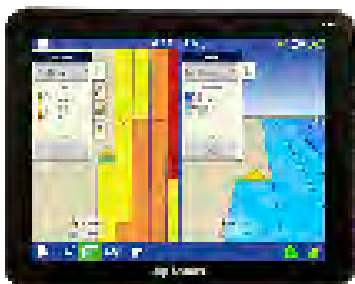

### Ag Leader®

Operations will gain visibility into yield and moisture information through real-time mapping on Ag Leader's InCommand™ display, convenient data management through AgFiniti® and GPS steering using SteerCommand™.

### Climate FieldView™

Use FieldView™ year round to make data driven decisions to maximize your return on every acre. An agronomic data partner to seamlessly collect, store, and visualize critical field data, monitor and measure the impact of your agronomic decisions on crop performance, and manage field variability by building customized fertility and seeding plans for your fields to optimize yield and maximize profit.

**CLIMATE**  
**FIELD**  
**VIEW™**

# The drive system. Economical power pack.

## CPS – CLAAS POWER SYSTEMS.

Optimal drive for best results.

Equipment development at CLAAS means an ongoing effort for even greater efficiency and reliability as well as optimal profitability in the field.

Of course, this applies to all aspects of a CLAAS forage harvester. A case in point is the drive system which is of decisive importance for the performance of the entire machine and which calls for a lot more than just a powerful engine.

In CLAAS POWER SYSTEMS (CPS), we have brought together top-quality components to create a drive system that is in a class of its own – one that always delivers the most efficient power when needed. CPS is ideally matched to the work systems, featuring fuel-saving technology that quickly pays for itself.

The intelligent DYNAMIC POWER engine control system from CLAAS provides the best possible implementation of the CPS philosophy: optimal, automatic provision of the appropriate power for the JAGUAR in line with requirements. It is another example of our approach to achieving real fuel savings. The decisive factor is not the engine itself but the ability to control the available output intelligently - so you can do more with less.



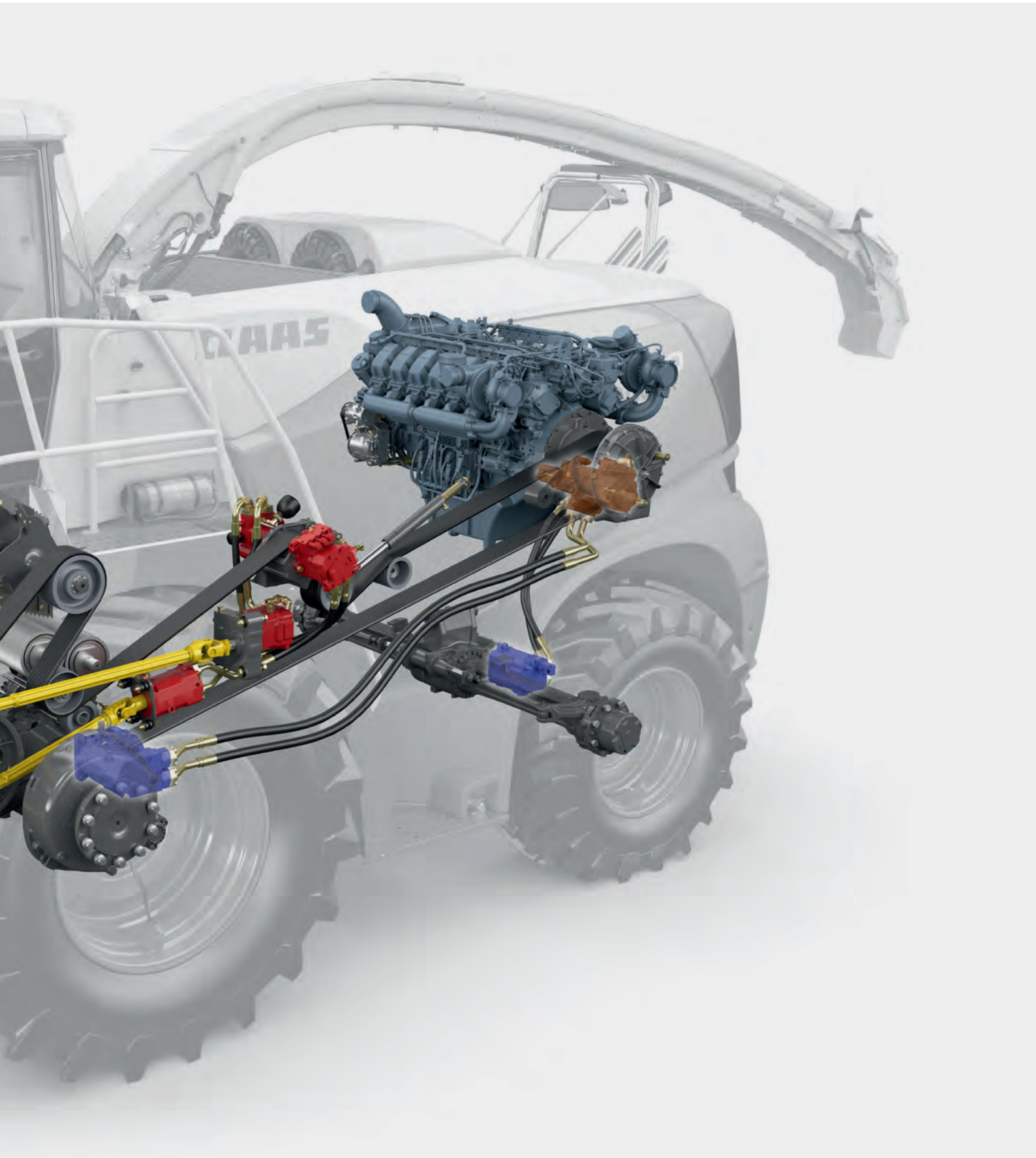

The engine technology.  
Up to 884 hp in one block.

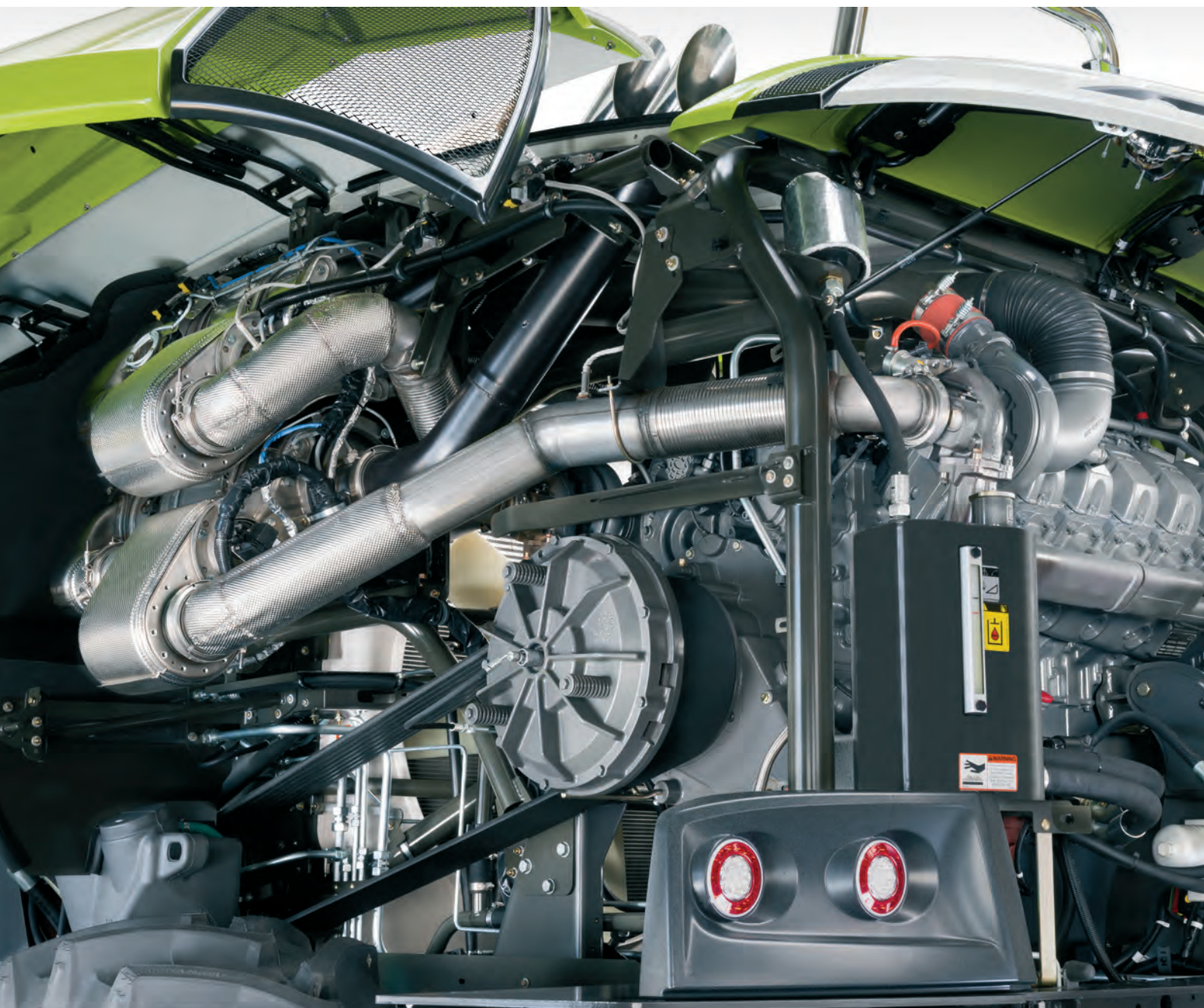

#### CLAAS POWER SYSTEMS.

CPS encompasses the full range of drive technology and matches it with the appropriate engine to form an optimally tuned drive system. This results in the highest level of efficiency available in the market.

### MAN and Mercedes-Benz technology.

The JAGUAR 980 and 970 are equipped with large MAN V12 engines, and JAGUAR 960-930 models operate on Mercedes-Benz S6 engines. These engines offer extremely smooth operation and exceptional efficiency.

This system uses the selective catalytic reduction (SCR) principle to convert the nitrogen oxides in the exhaust flow into nitrogen and water. The urea solution necessary for this is carried in a 34.3 gal (130 l) tank. Urea consumption is about 3% of the diesel consumption. The latest SCR technology is integrated into the JAGUAR forage harvesters with the MAN V12 24.2 l engine (980 - 970) and Mercedes-Benz S6 15.6 or 12.8 l engines (960 - 930) includes such highlights as:

- Common rail, high-pressure injection technology (23,210 psi (1600 bar))
- Torque is consistent over a wide engine speed range
- Twin catalytic converter (980-970)
- Very low diesel consumption
- Compliance with emissions standards by means of SCR technology



### High-capacity fuel tank.

JAGUAR	Diesel tank	Auxiliary diesel tank	Diesel, total	Urea tank
980-930	277 gal (1050 l)	79 gal (300 l)	356 gal (1350 l)	34.3 gal (130 l)

### High engine output.

		hp	kW	Liters
JAGUAR engines	Type	Tier 4 final		Displacement
980 with MAN V12	D2862	884	650	24.24
970 with MAN V12	D2862	800	588	24.24
960 with MB S6	OM 473	626	460	15.6
950 with MB S6	OM 473	585	430	15.6
940 with MB S6	OM 471	516	380	12.8
930 with MB S6	OM 471	462	340	12.8



MAN V12 D2862



Mercedes-Benz OM 473



Mercedes-Benz OM 471

# DYNAMIC COOLING. (optional)

Effective cooling.

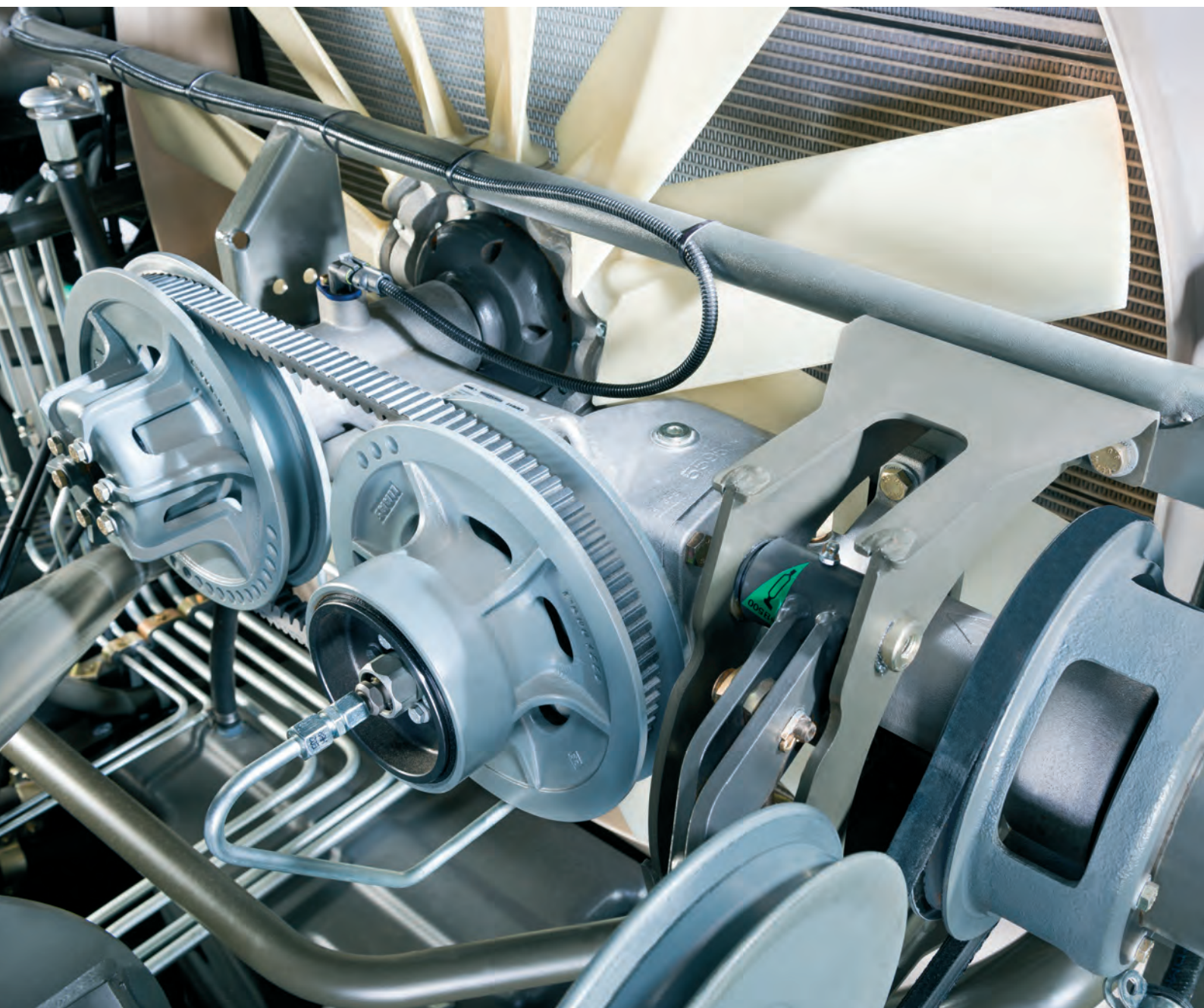

## The benefits at a glance.

- DYNAMIC COOLING.
  - Only as much cooling as necessary
- Power saving of up to 26 hp (20 kW)
- Fan speed reserve of up to 15% for performance peaks



Functional design with perfect venting of hot engine air



### Dynamic cooling system saves fuel.

A highly efficient variator drive is available as an option for the JAGUAR 900 model series. DYNAMIC COOLING identifies the requirements of all three cooling units: engine coolant, charge-air cooling system and hydraulic oil system. When operating at partial load or on the road, a reduced fan speed is often perfectly sufficient. In this way, it is possible to save up to 26 hp (20 kW); so you save on fuel.

In very hot regions, DYNAMIC COOLING can even enable an increase in fan performance of up to 15% compared with the conventional cooling system. This ensures a sustained high level of cooling performance.

### Clean cooling.

In the JAGUAR, horizontal slab radiators provide effective cooling under all harvesting conditions. The large surface area of the radiator screen keeps air speeds down, thereby reducing dirt build-up. A rotating extractor arm keeps the screen clean.

### Functional design.

The airflow from the fan is directed past the engine and can escape practically unhindered through the large rear air outlet formed from expanded metal grilles. As a result, the JAGUAR can be counted on to cope reliably with challenging demands, even in extremely hot weather.

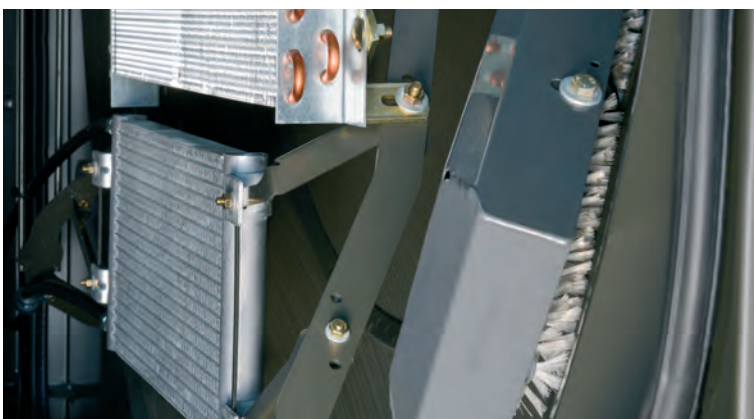
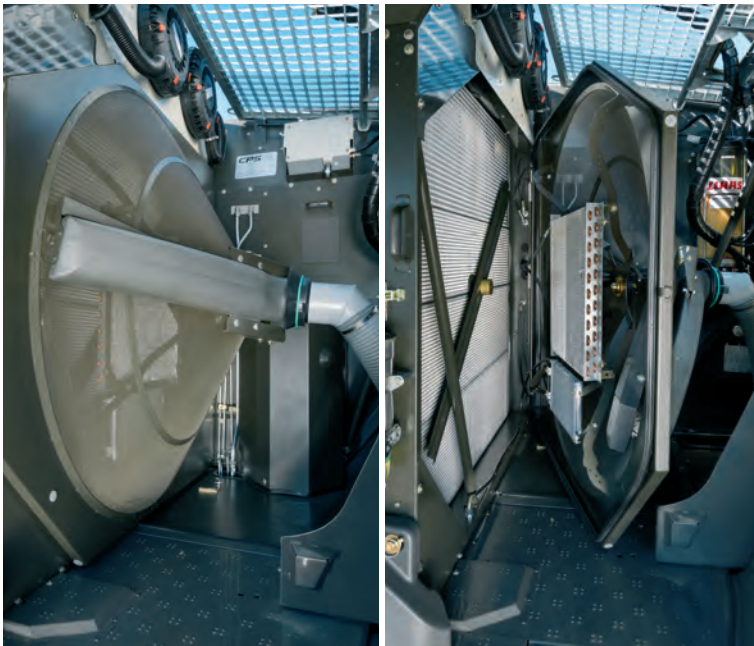

# CRUISE PILOT. Automatically on course.



## The benefits at a glance.

- Greatly eases the operator workload
- Constant throughput with optimal engine efficiency
- Activation of CRUISE PILOT by means of the CMOTION or Multi-Function control lever







### Optimal engine load.

The automatic control of the ground speed by CRUISE PILOT allows the engine load to be used to the full. The operator specifies the desired engine load in CEBIS by setting the corresponding engine speed. CRUISE PILOT is activated easily by means of the control lever. The JAGUAR now adjusts its performance to operate at the set engine load all the time. If the crop suddenly becomes more dense, the ground speed is reduced automatically. If the crop density diminishes again, the JAGUAR increases the ground speed until the preset engine output is attained. This automatic adjustment is based on the detection of the throughput and the engine load.

CRUISE PILOT is an operating mode. You choose the appropriate strategy:

- Cruise control
- Constant throughput
- Engine load

You can use the HOTKEY direct menu rotary switch to adjust the selected mode in accordance with the operating conditions while the machine is running.

- Greatly eases the operator workload
- JAGUAR performs at maximum efficiency

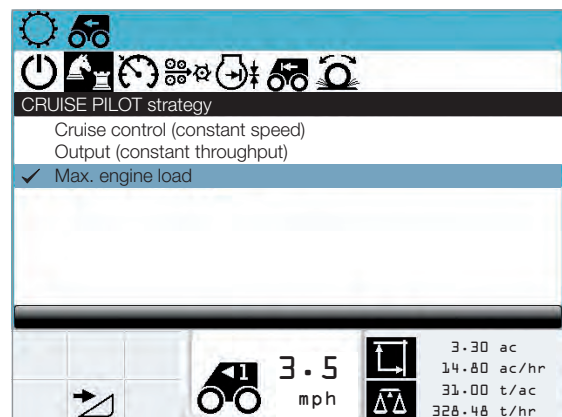
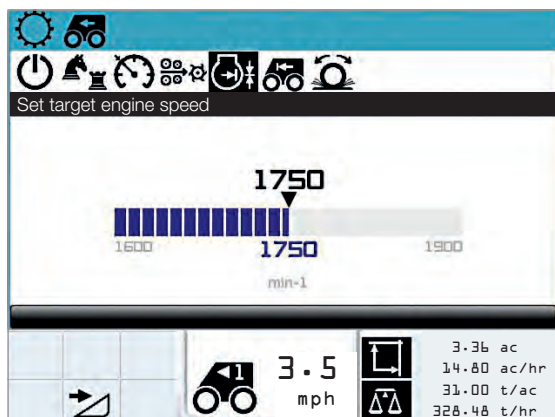

DYNAMIC POWER. (optional)  
Appropriate efficiency, low consumption.



The benefits at a glance.

- DYNAMIC POWER: automatic engine output control
- Save diesel during partial-load operation

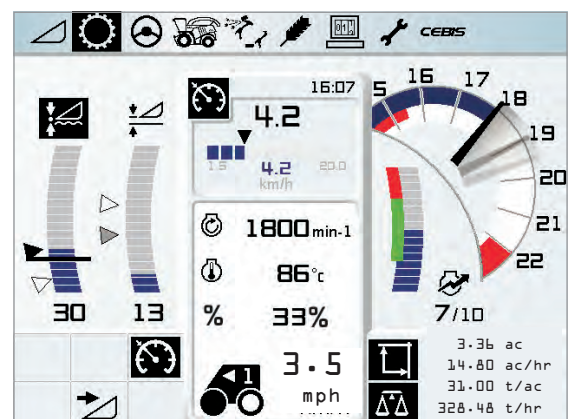

### Automatic adjustment of engine output.

The JAGUAR 980 - 940 models can be equipped with the DYNAMIC POWER automatic engine output control system.

Maximum efficiency and throughput are attained when operating at full load. In the partial load range, the engine output is reduced automatically. This makes it possible to achieve fuel savings of up to 10.6%.

Before entering the field, DYNAMIC POWER switches to the maximum engine output. This is made possible through the intelligent combination of the engine load, ground speed and working position.

If maximum power is no longer required after entering the field, DYNAMIC POWER reduces the output to the appropriate setting.

DYNAMIC POWER adjusts the engine output optimally to the field conditions in ten steps. This ensures that you are always operating in the most efficient engine speed range.

- Save diesel during partial-load operation
- Economical, consistent working with cruise control

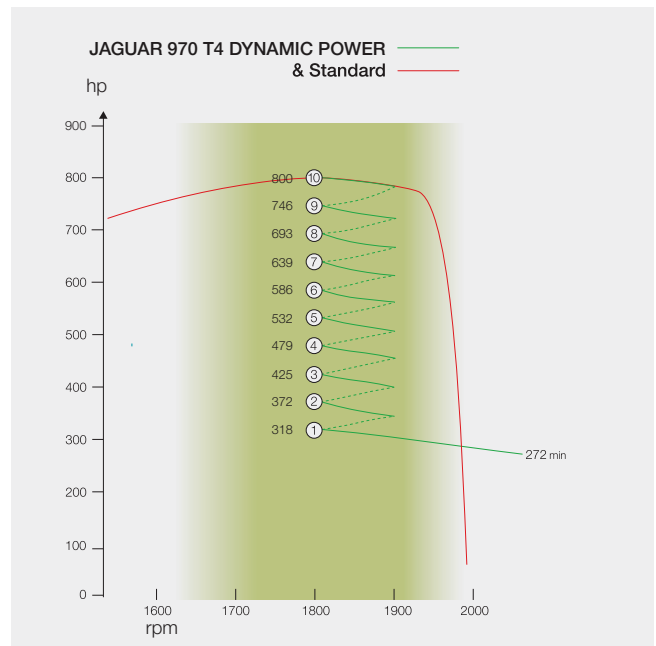

Engine output in hp.

Selectable	JAGUAR step	980	970	960	950	940
Maximum output	10	884	800	626	585	516
	9	823	746	591	554	492
	8	762	693	555	522	467
High output	7	700	639	520	491	443
	6	639	585	484	460	418
	5	578	532	449	429	394
	4	517	479	414	397	370
Normal output	3	455	425	378	366	345
	2	394	372	343	335	321
	1	333	318	307	303	296
	at least	272	272	272	272	272

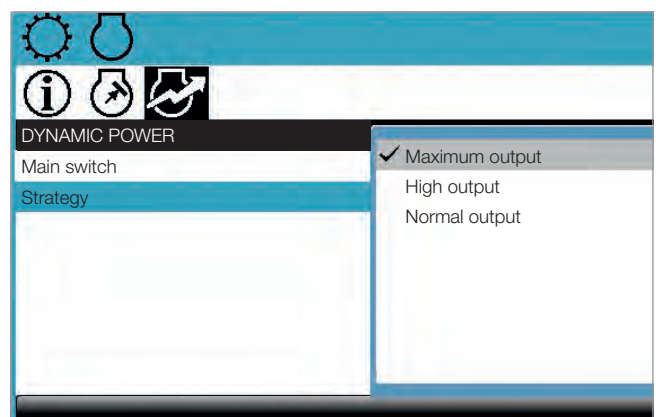

The running gear.  
Designed to put the power down optimally.



#### Front axle.

Impressive highlights of the JAGUAR fitted as standard include the new drive axle for up to 25 mph (40 km/h), a 2-speed manual transmission and an automatic parking brake. A differential lock, tire pressure adjustment system and front duals are available as options.

#### The benefits at a glance.

- Double hydrostatic motor with wide speed range
- Differential lock for improved traction
- Automatic parking brake for enhanced safety and convenience
- Dual front tires as an option

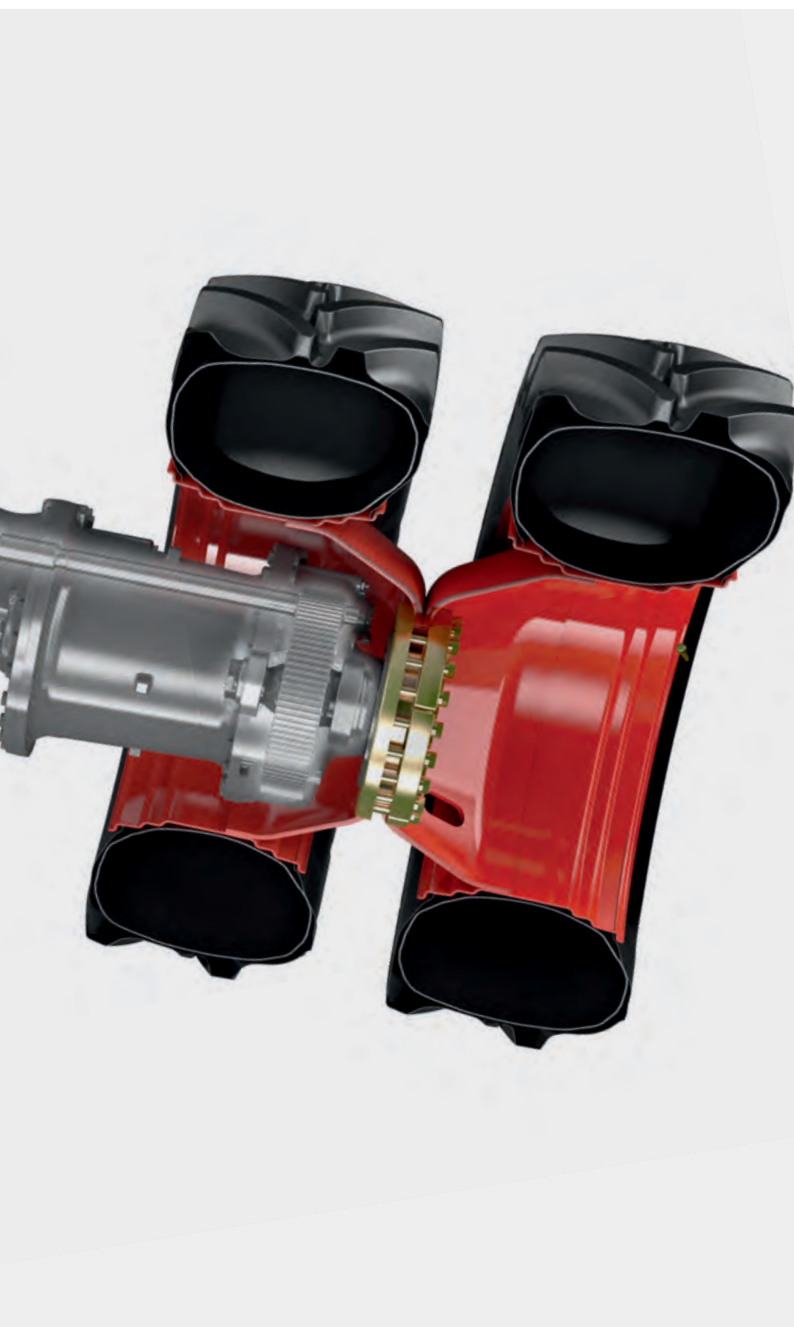

## Double hydrostatic motor with wide speed range.

Advantages of a double hydrostatic motor for the drive axle:

- Speed of up to 13.5 mph (22 km/h) possible in first gear – increased operational flexibility and greater comfort and convenience during field work
- The automatic reduction of up to 1400 rpm in the diesel engine speed saves fuel when turning at the headland or when stopping for the changeover of an offloading trailer
- During on-road travel, an engine speed of just 1290 rpm reduces fuel consumption and engine noise
- Pulls away powerfully on the road, in the field and on slopes

## Differential lock. (optional)

For improved traction, the drive axles can be locked using a multi-disc clutch. The operator has a choice of three settings:

- The automatic engagement system recognizes if a wheel on the drive axle slips and locks the front axle automatically. Recommended when harvesting with AUTO PILOT.
- The automatic disengagement system keeps the clutch closed, opening it if the speed exceeds 9 mph (15 km/h), if there is steering correction or if braking occurs.
- Manual engagement is suitable for short-term use in very heavy-going and difficult terrain

## Automatic parking brake.

If the control lever is in the neutral position, the parking brake engages automatically when the machine comes to a stop.

This prevents it from rolling away unintentionally on a slope.

Furthermore, gear changing can be done comfortably without having to use the brake pedal. Headers can be coupled easily thanks to the very sensitive pull-away response.

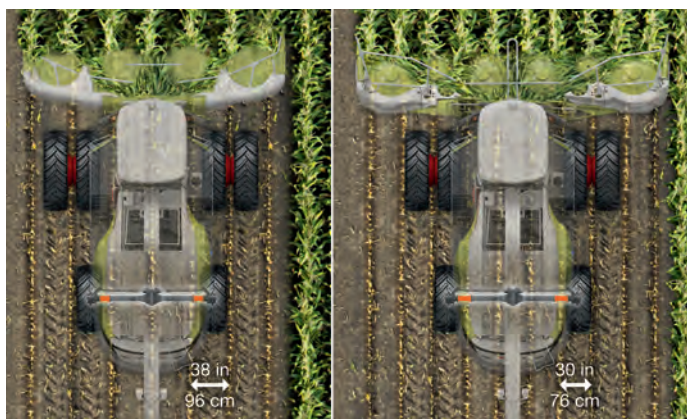

## Front dual tires.

- Four 520/85R42 dual tires
- Front tires fit 30 in or 38 in rows without driving on stalks
- Excellent flotation and stability
- Excellent traction
- Axle is especially designed for duals and can handle large headers like the ORBIS 900

Tire pressure adjustment system. (optional)  
Optimal traction at all times.



The benefits at a glance.

- Exclusive to CLAAS: tire pressure adjustment system for drive axle and steering axle.
- POWER TRAC for 40% traction engagement with driven steering axle
- Tight turning radius thanks to tilted rear axle geometry



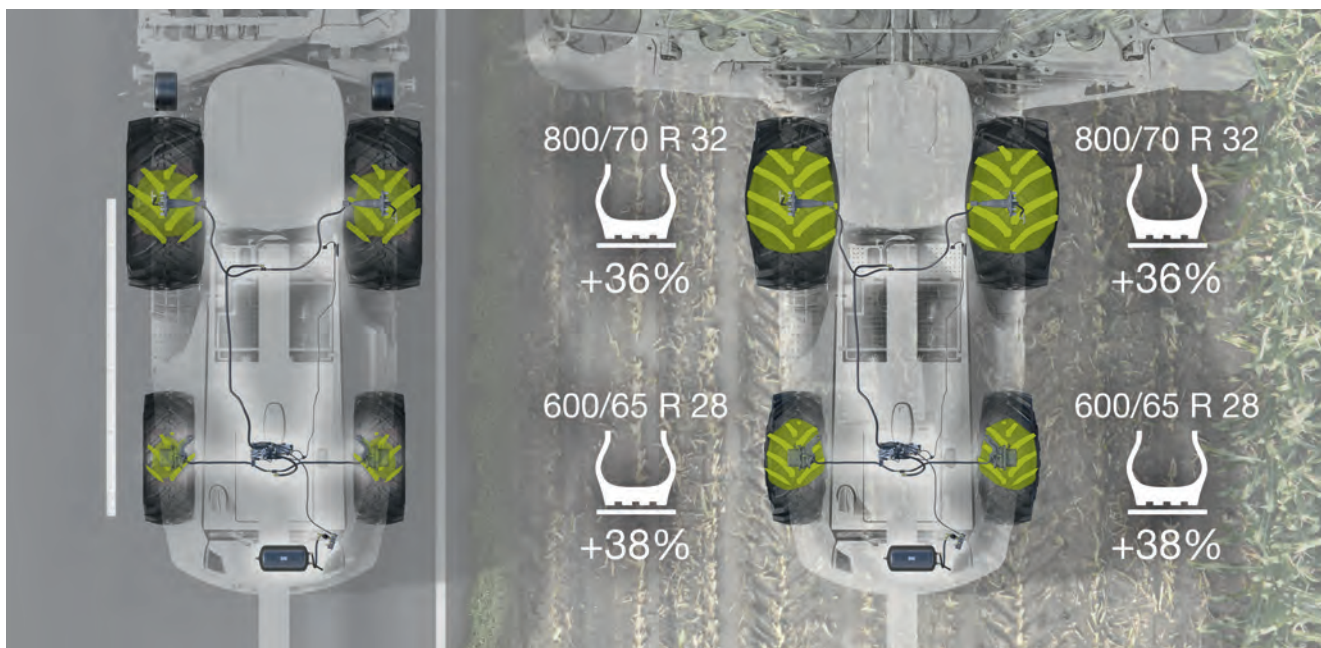

Tire pressure adjustment system for drive axle and steering axle.

If it starts raining or the ground traction is poor, it is possible to react by adjusting the pressure of the front tires conveniently from the cab. Furthermore, adjustment for on-road running and in-field operation takes place automatically. Reduced tire pressure means that the machine is very gentle on the field while delivering maximum traction and providing an extremely comfortable ride. A field study by the South Westphalia University of Applied Sciences has shown that reducing the tire pressure makes it possible to reduce ground drive diesel consumption by 5%.

POWER TRAC – all-wheel drive for more pulling power.

If the JAGUAR is operating in classic 2-wheel-drive mode, up to 40% more pulling power can be called on by engaging POWER TRAC. When harvesting with the PICK UP, the traction of the driven steering axle is reduced automatically. This protects the grass cover in all-wheel-drive mode.

High ground clearance and tight turning radius.

On standard tires, the JAGUAR has a ground clearance of up to 17.5 in (450 mm).

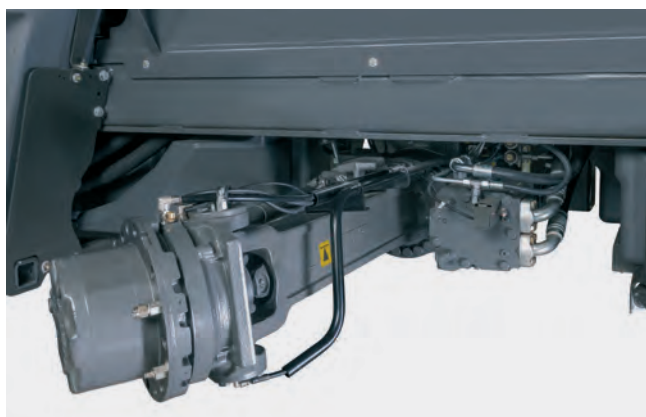

Hydraulics and electrics.  
Clear layout.

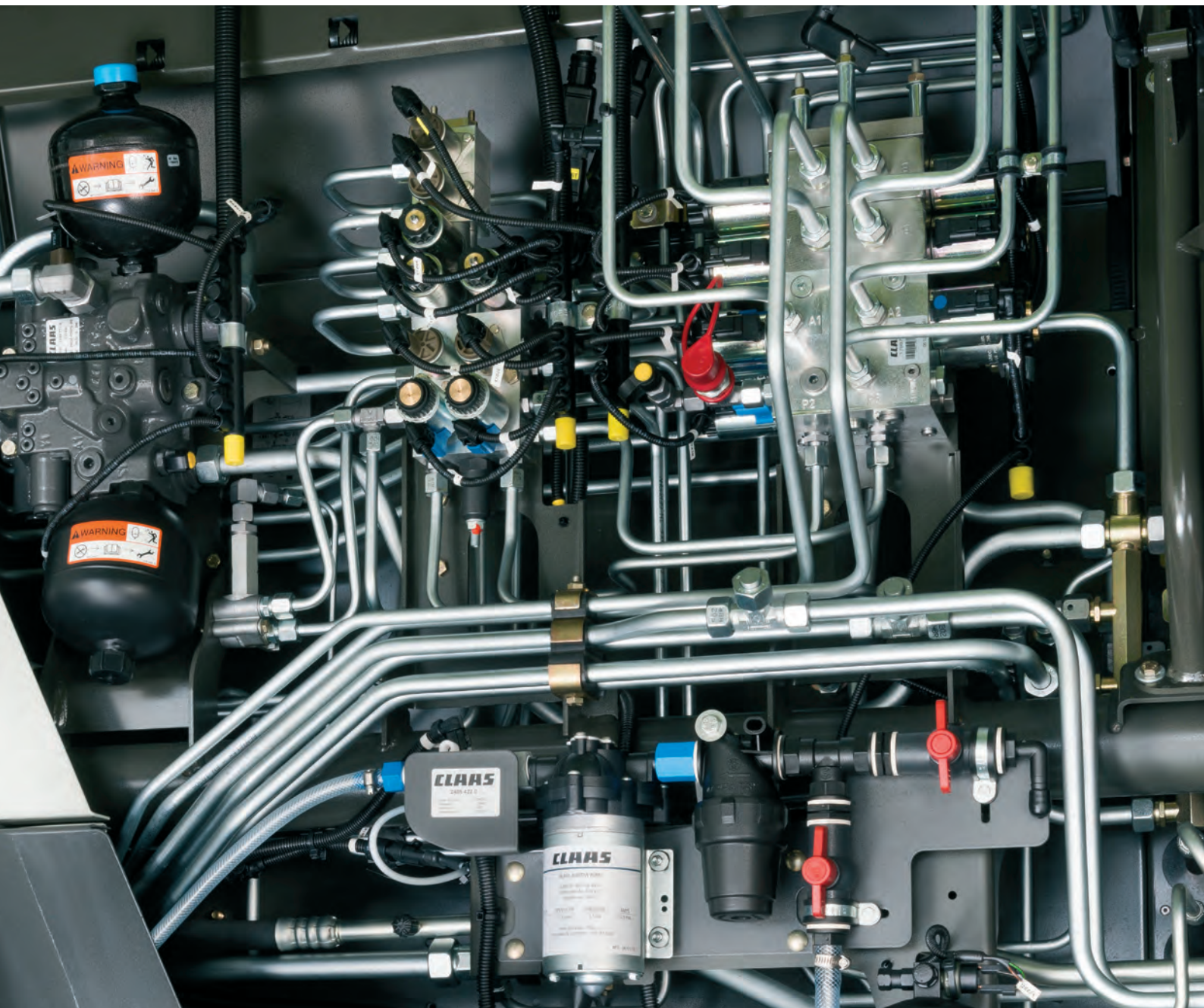





### Hydraulics control.

The spool valves are clearly laid out on the left side of the machine. Proportional valves for the discharge spout and header control system allow a smoother response when these systems are functioning automatically. In order to enable a consistent stubble profile, even when operating at very high ground speeds, the swivel speed of the ORBIS lateral levelling mechanism, for example, can be adjusted as required in CEBIS.

### Vibration damping at the headland.

The vibration damping system is activated automatically once the headland is reached and the header raised past the working height. This additional convenience feature reduces wear and tear on the machine when crossing sprayer wheelings, for example. The header is protected by a correspondingly gentle suspension response.

- Rapid implementation of function commands
- Efficient control by proportional valves
- Cost-effective maintenance thanks to low-volume oil system



### Easy-maintenance electrical system.

A straightforward, convenient control concept demands a fast, reliable electrical system. In the JAGUAR, all the key components are housed securely and centrally in the cab. An expansion box in the maintenance compartment of the JAGUAR allows the easy accommodation of additional options when retrofitting:

- PROFI CAM
- AUTO FILL
- ACTISILER 37
- NIR sensor
- QUANTIMETER
- Auxiliary diesel tank, 79 gal (300 l) standard
- Accelerator gap setting
- Tire pressure regulation system
- DYNAMIC COOLING

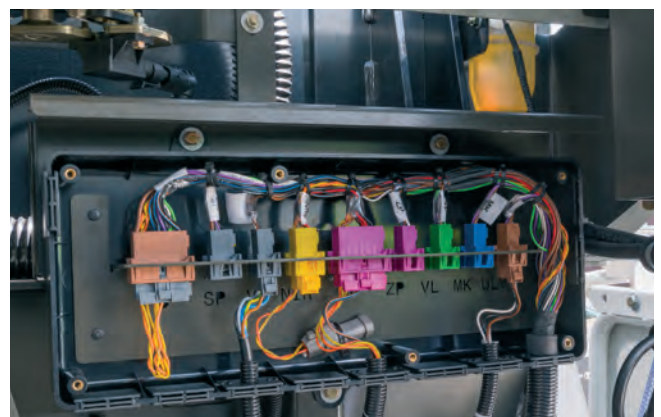

# The chopping system. Powerful, precise, razor-sharp.

Peak performance and cost-effectiveness. JAGUAR technology.

- High performance with economical engines
- Straight-forward, highly efficient drive system
- COMFORT CUT infinitely variable chop length adjustment
- Variable header drive (optional) with automatic speed adjustment in event of chop length modification
- Chopping cylinder features up to 36 knives for first-class, consistent chopping quality
- Automatically adjustable drum concave
- Large, low-noise cab
- Maximum throughput with low power consumption





# The drive. Best in class.

Tough, reliable and low-maintenance. Five features guarantee top efficiency:

- 1 Transverse-mounted engines
- 2 Direct powerband drive from engine to:
  - Chopping assembly
  - Accelerator
  - COMFORT CUT (infinitely variable chop length adjustment)
  - Variable header drive
- 3 The Corncracker is driven directly from the accelerator by a powerband
- 4 QUICK STOP – active braking brings the crop flow to a halt quickly when the main drive is disengaged
- 5 The possible header drive types: variable, split-power, standard

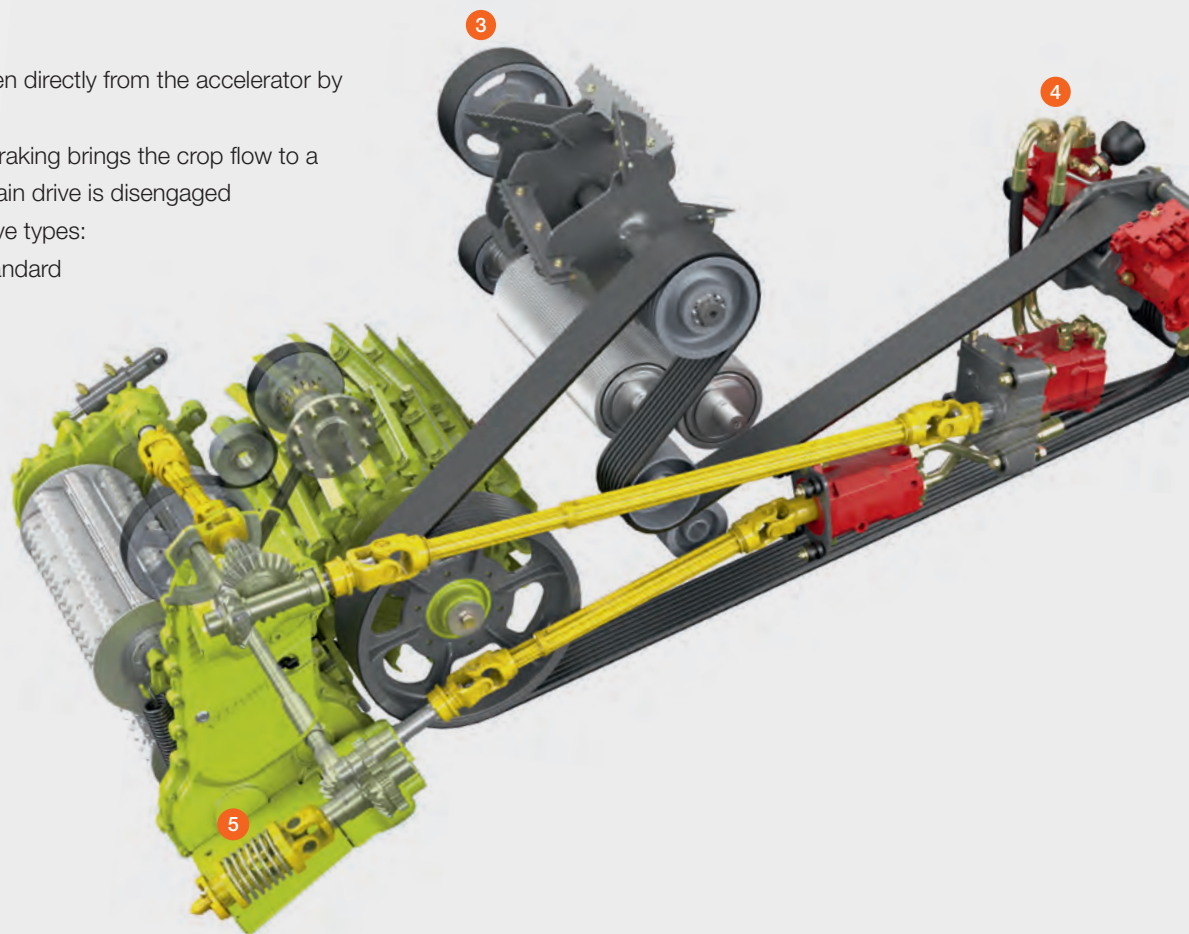

## The benefits at a glance.

- The JAGUAR main drive: powerful, robust and requires little maintenance
- The drive system: highest efficiency factor in market comparisons

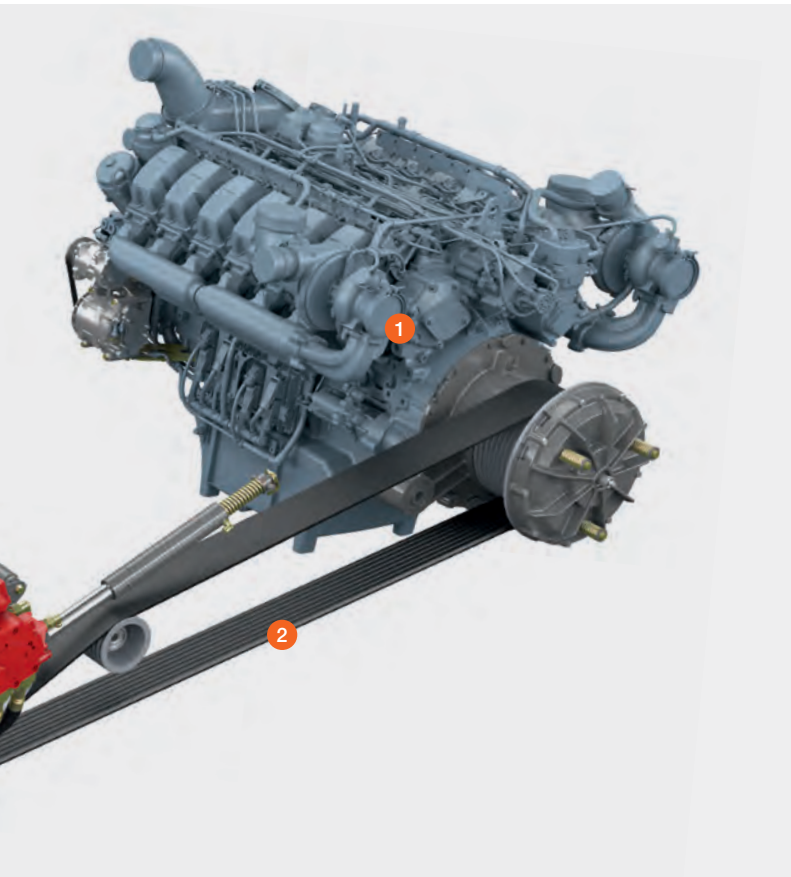

### The JAGUAR drive line.

The JAGUAR power flow is quite simply the most efficient design on the market. The chopping mechanism is driven directly from the engine's crankshaft via a long, maintenance-free powerband. This design is still unmatched even today, many years after it was developed.

- The pre-compression roller drive is integrated into the main drive line
- Thanks to the COMFORT CUT pre-compression roller drive, the operator can adjust the chop to any required length from the comfort of the cab while the machine is underway
- The whole intake is designed for maximum reliability, outstanding durability and a long service life, with rugged drives, large bearings and gears
- The headers are attached to the JAGUAR by means of a quick coupling and can be driven in standard, split-power or hydraulic variable mode



The drive in action.  
As animation online here.

[jaguar-drive.claas.com](http://jaguar-drive.claas.com)



# The crop flow. Straight and fast.

Maximum throughput with low power consumption.

An optimal crop flow is a major factor in determining the daily output. The crop flows in a straight line through the entire machine without any awkward angles. The crop is accelerated further at each step and is centered increasingly by the chevron arrangement of the knives and accelerator paddles. This results in maximum performance with minimum power consumption and makes for highly reliable operation. The JAGUAR demonstrates this time after time: with outstanding results – measured in terms of fuel consumption in gallons (liters) per ton.

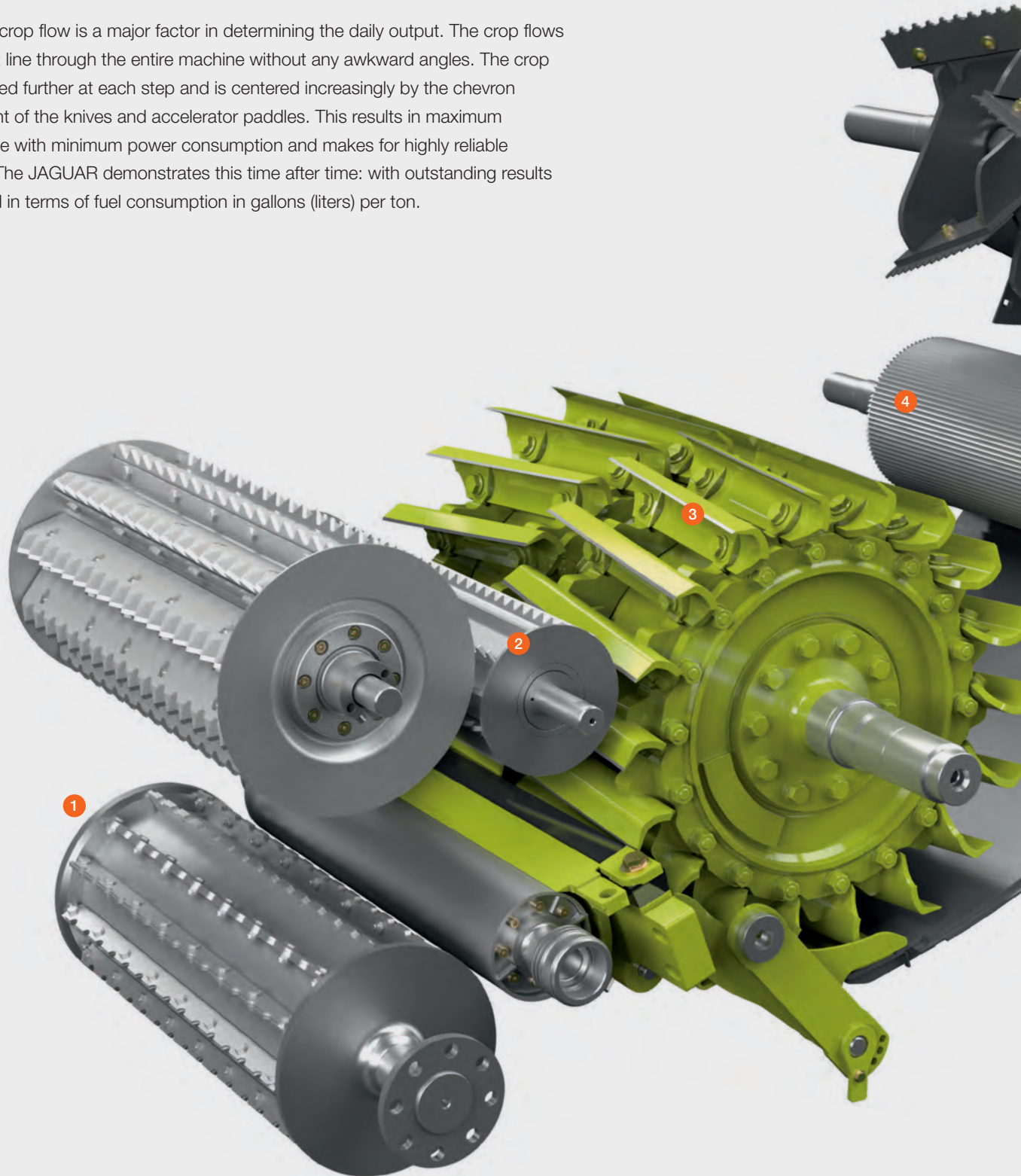

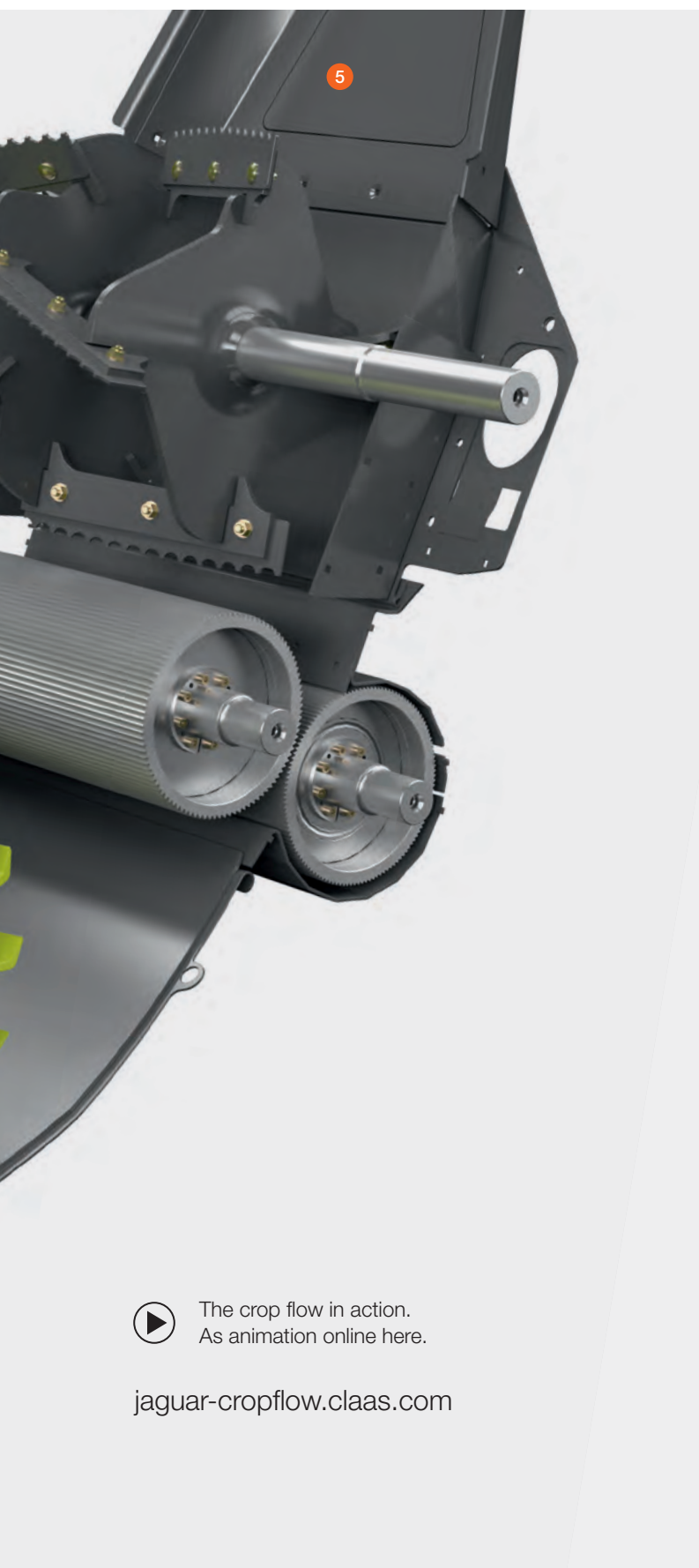

The crop flow in action.  
As animation online here.

[jaguar-cropflow.claas.com](http://jaguar-cropflow.claas.com)



- 1 Header
  - Variable header drive enables consistent crop flow from header and intake for consistently high chop quality
- 2 Intake
  - Intake rollers with an opening of up to 7 in (180 mm) for high throughput
  - Continuous precompression for excellent chop quality
  - Chopping cylinder is easily accessible thanks to QUICK ACCESS
- 3 V-MAX knife drum
  - V-MAX knives are attached to the drum by tightening the bolts until they lock; no adjustment is necessary
- 4 MULTI CROP CRACKER
  - The right arrangement for a high-quality processing result
- 5 Flexible acceleration (optional)
  - Accelerator clearance can be set from the cab, ease of operation for high efficiency

# Variable header drive. Something for everyone.

Optimization of chopped material and crop flow.

CLAAS offers three types of header drive for the new 900 model series:

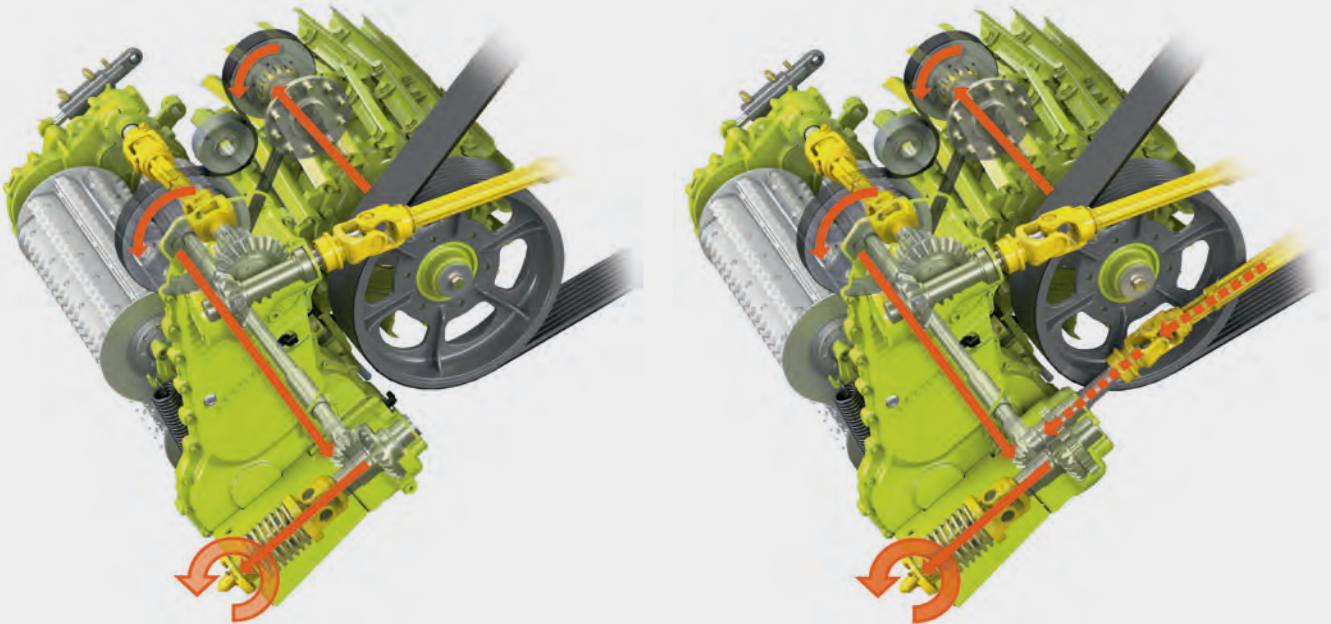

## 1. Mechanical version.

- For all headers
- Driven by chopping cylinder shaft, all-mechanical with constant speed, engaged via a belt clutch to the quick coupling
- Excellent efficiency

## 2. Split-power variant. (optional)

- For use with DIRECT DISC or earlage
- Mechanical drive via the chopping cylinder shaft and also hydrostatic
- Maximum power transmission at a constant speed

## The benefits at a glance.

- Three drive variants
- COMFORT CUT infinitely variable chop length adjustment which can be automated
- Two-stage reversing with hydrostatic variable header drive



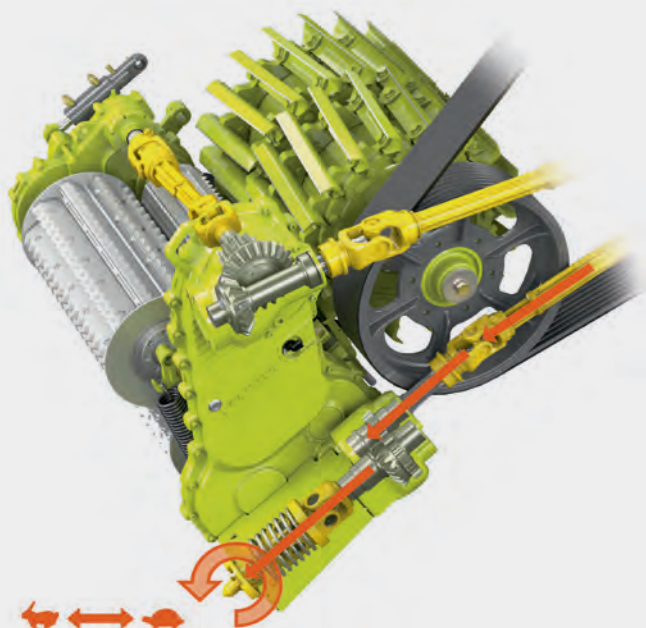

### Efficient main drivetrain.

Like the COMFORT CUT infinitely variable chop length adjustment which can be automated, the variable header drive is integrated in the main drivetrain. The advantage of this arrangement is that, in the event of any speed variations, the header drive, the intake drive, drum speed, accelerator and corncracker are affected equally. This results in a constant chop length at all times.

### 3. Hydraulic variable header drive. (optional)

- For ORBIS corn headers and PICK UP
- All-hydrostatic drive
- Optimal crop flow between header unit and intake elements, manual or automatic speed adjustment to the preset chop length with low power requirement
- High efficiency

### Two-stage reversing with hydraulic variable header drive

Two-stage reversing is possible in combination with the CMOTION control lever. Either the header is reversed alone, or the header and the intake are reversed together.

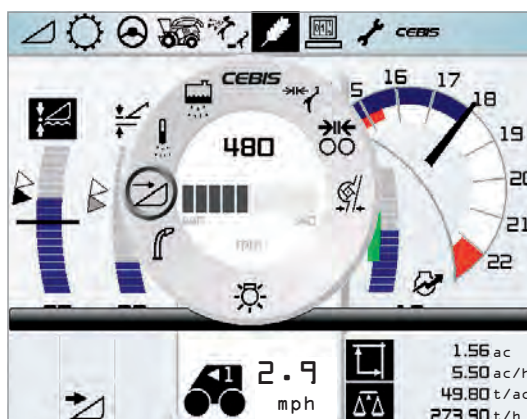
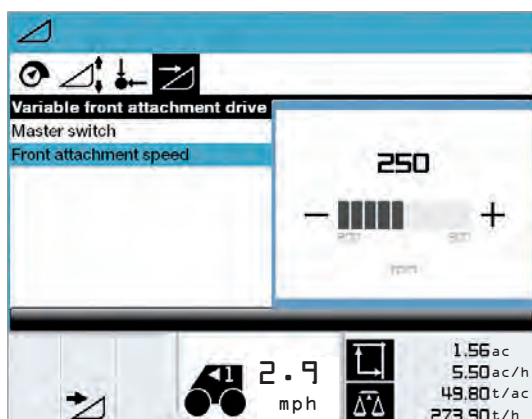

The intake.  
Consistent high performance.



The benefits at a glance.

- High-performance drive and powerful reversing
- Infinitely variable chop length adjustment - also automatic on basis of dry matter
- Maintenance-friendly thanks to quick access to drum assembly



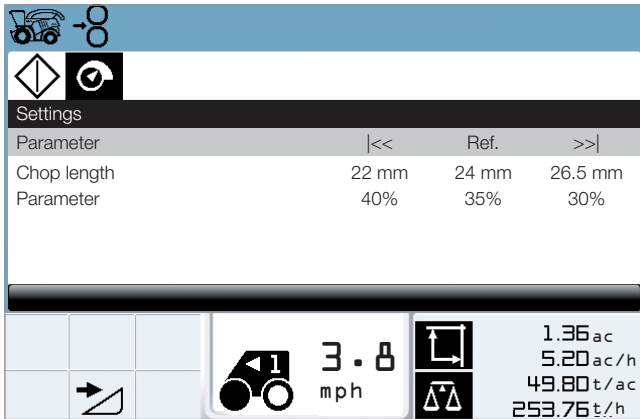

Consistent chop length is maintained.

The intake system of the JAGUAR is powerful, economical and can be adapted to different field conditions. The COMFORT CUT drive, which is integrated in the main drivetrain. Its advantage: variations in the engine speed and, therefore, in the cylinder speed at the same time, are matched by corresponding changes in the COMFORT CUT drive. This results in consistent chop quality at all times. The operator sets the required chop length in CEBIS. The chop length can also be adjusted infinitely during the harvesting process.



Automatic chopping length adjustment (optional).

The chop length can be adjusted in line with the measured dry matter content. The operator can preset the adjustment range in CEBIS. With a dry matter content of 40 %, for example, the chop length is set to 22 mm while a 30 % content results in chopped material measuring 26.5 mm. In this way the JAGUAR automatically produces perfect silage for optimum compression in the pit - even in the case of areas where the dry matter content is extremely inconsistent.

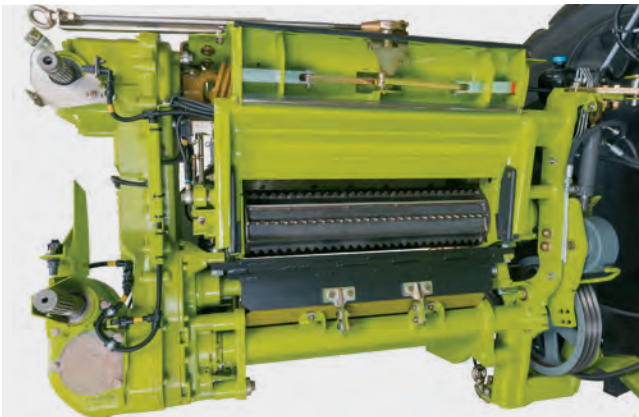

Excellent accessibility with QUICK ACCESS.

When it is necessary to carry out maintenance or service work on the intake or the chopping assembly, the intake can be pivoted to the side quickly. It is also possible to benefit from this convenient access in the field simply by removing the header.

Precompression.  
Continuous and reliable.



The benefits at a glance.

- Continuous precompression
- Detectors for foreign bodies and magnetic metals
- DIRECT STOP



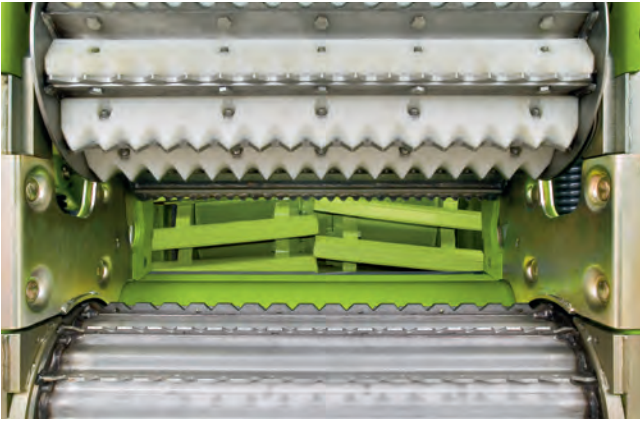

### Continuous pre-compression.

The damper (1) in the form of a hydraulic ram is an updated addition to the precompression process, which maintains the even distribution of precompression forces on the upper intake rollers, optimizing the efficiency of the overall process.

### Consistent precompression.

The intake ram (2) acts as a precompression force directly on the rear upper precompression roller. Unlike spring-based systems, this ensures optimal precompression force is available in every crop situation. Unaffected by crop height, this precompression maintains even feeding for constant chop quality, especially when entering and leaving the field.



### Hydraulic precompression (optional).

The new hydraulic precompression ensures smoother crop flow by automatically adjusting the precompression rollers to maintain constant pressure in all intake heights. The operator sets the desired pressure from CEBIS and the activated system manages pressure adjustments automatically.

### Highly sensitive detectors.

Having a powerful and robust intake is only part of the story – it's also highly sensitive to foreign objects, thanks to the built-in detectors. Now equipped with five magnets, the metal detector protects the JAGUAR against magnetic objects. The detection sensitivity can be adjusted individually, and a pinpointing indication on the CEBIS monitor makes it easier to determine where the object is located.



Additional protection for the JAGUAR is offered by the STOP ROCK detector which stops the intake immediately if it detects a foreign body of a size greater than that preset by the operator.

Adjustment of the preset size can be carried out in CEBIS. The wear-free, quick brake for the intake rollers and header works efficiently even when the intake is operating at full speed, enabling the operator to work with confidence.

### DIRECT STOP to protect the machine.

When the metal detector or STOP ROCK is activated, the JAGUAR automatically comes to a stop. This quick response prevents the crop from piling up.

The V-MAX chopping cylinder.  
Precise chopping, easy service.

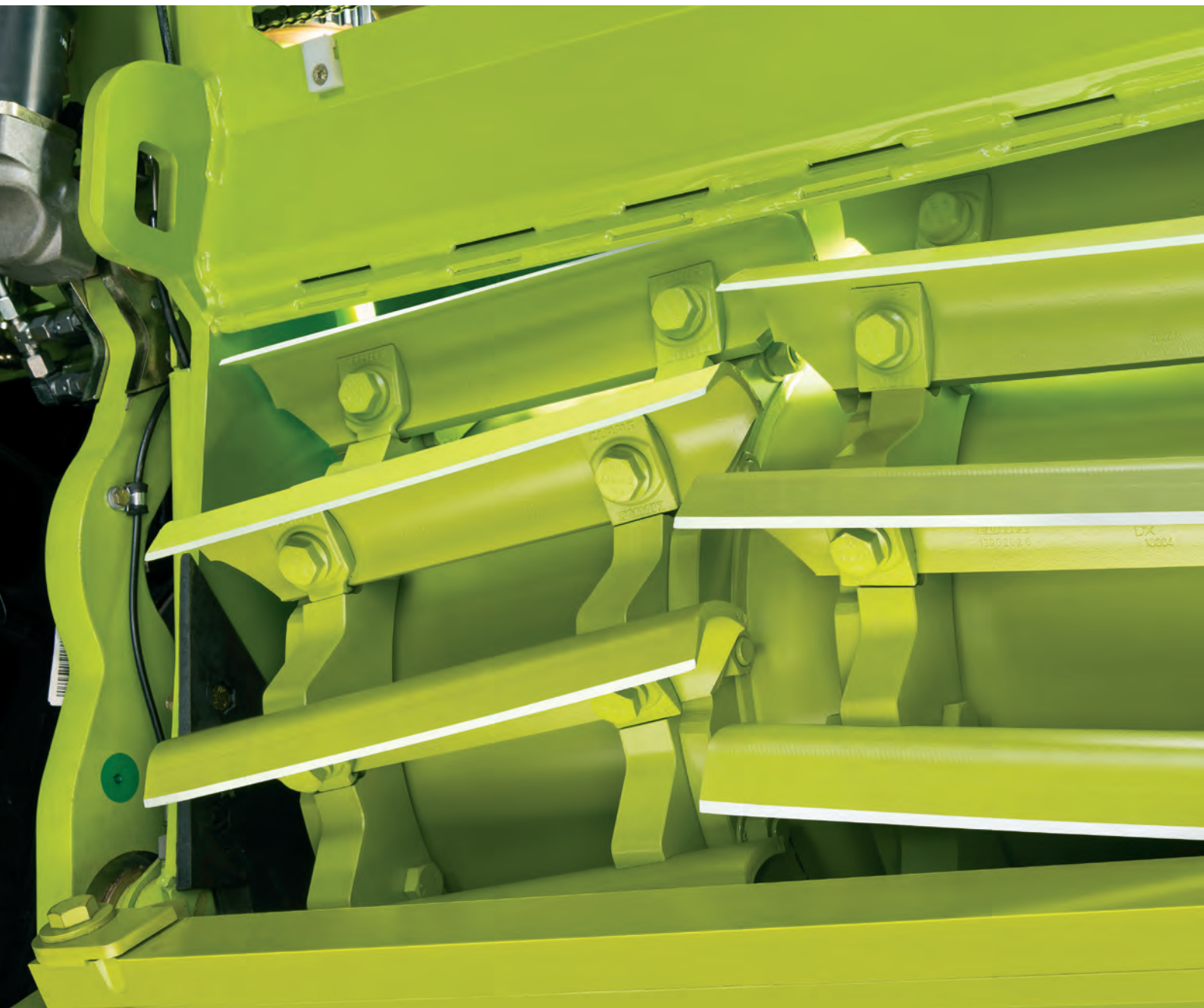

The benefits at a glance.

- V-MAX chopping cylinder in four variants
- QUICK ACCESS: convenient maintenance keeps set-up times to a minimum

Drum	Parameter
V-MAX 36 extended	Knife set
	Chop length
V-MAX 28 extended	Knife set
	Chop length
V-MAX 24 extended	Knife set
	Chop length
V-MAX 20	Knife set
	Chop length



Four variants with no need for adjustment.

CLAAS offers four variants of the V-MAX chopping cylinders with differing knife configurations in accordance with the different market requirements.

- Optimum chop quality through precise cutting
- Extremely smooth, power-saving action: the curved shape of the knives makes for an optimum crop flow
- High strength: chopping forces are taken up directly by the star-shaped drum
- Extremely easy to assemble: only two bolts per knife
- There is no need to adjust the knives. They are bolted directly to the star-shaped cylinder with the help of shaped fittings which act as templates.
- No need to adjust the knives
- A reduced knife set enables a longer chop length range when operating without a corncracker. Placeholders protect the knife sockets.

QUICK ACCESS.

Convenient maintenance keeps set-up times to a minimum: QUICK ACCESS offers you various options for carrying out maintenance and service tasks rapidly. The intake housing swings open to the side to provide quick and convenient access to the chopping cylinder for maintenance tasks. Thanks to the quick coupling, the header can be removed rapidly.



Knife arrangement of V-MAX extended chopping cylinder with half set of knives.



V-MAX chopping drum with knives removed.

	Knife set, complete	Knife set, half	Knife set, one third
	36 = 2 x 18	18 = 2 x 9	12 = 2 x 6
mm	3.5-14.5	7-29	10.5-43.5 (30 mm corn)
	28 = 2 x 14	14 = 2 x 7	
mm	4-18.5	8-37 (30 mm corn)	
	24 = 2 x 12	12 = 2 x 6	
mm	4-22	8-44 (30 mm corn)	
	20 = 2 x 10	10 = 2 x 5	
mm	5-26.5	10-53	



QUICK ACCESS: rapid access to the V-MAX chopping cylinder



Reduced number of knives for long chop lengths

# The chopping assembly. A sharp operator.

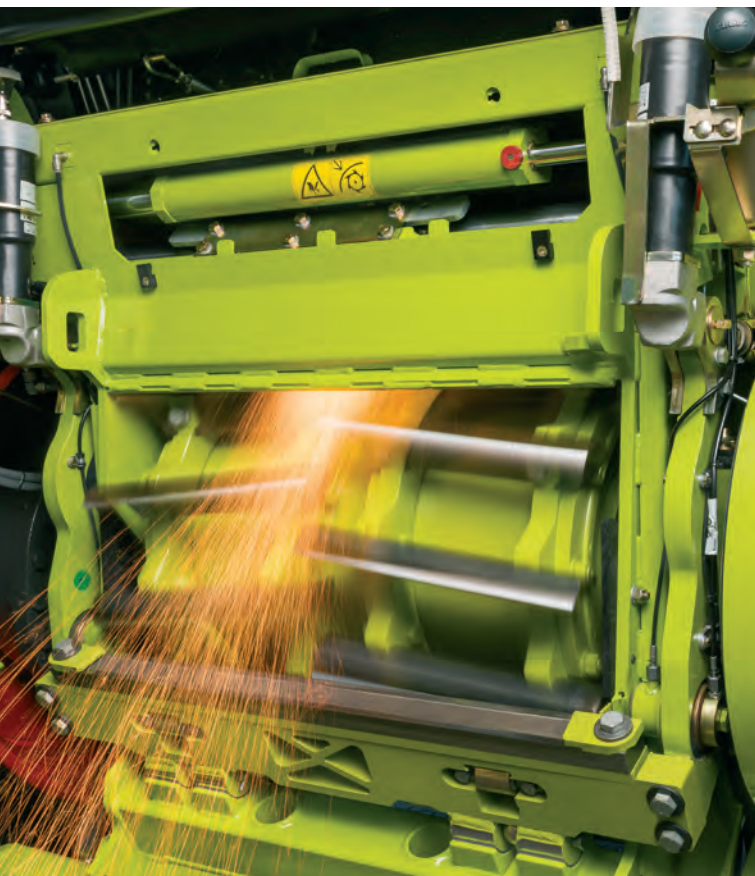

## Knife sharpening based on throughput.

Knife sharpening on basis of time elapsed of throughput? Configure your CEBIS as you require. CEBIS will remind you when knife sharpening is necessary on the basis of how you program it. In this way, you can be certain that knife wear is being managed correctly.

## The benefits at a glance.

- Knife sharpening based on throughput
- Shear bar secured hydraulically
- Automatically adjustable drum concave

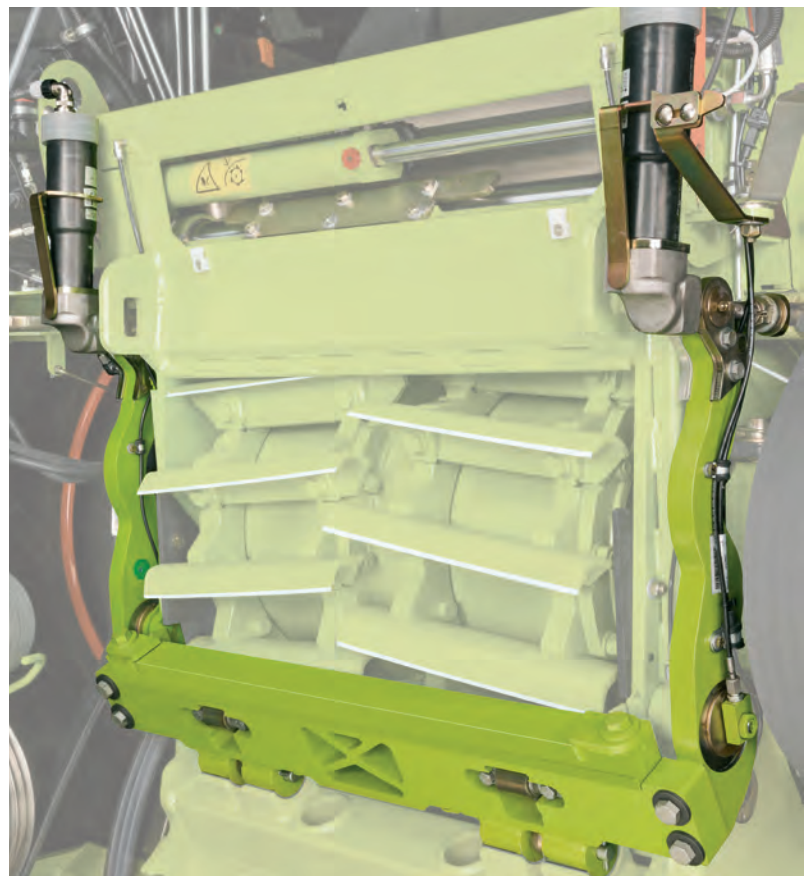

## Hydraulically locked shear bar.

The shear bar with the adjustment strip is attached securely to the mounting block by four bolts. In less than 60 seconds, the shear bar with the mounting block is pivoted towards the chopping cylinder which is rotating forwards. This is accomplished by the side shear bar clamp being released hydraulically before being secured again hydraulically after the adjustment procedure. In this way, the exact setting required for precise chopping is maintained reliably.



NEW: Sharpening stone guide bolt



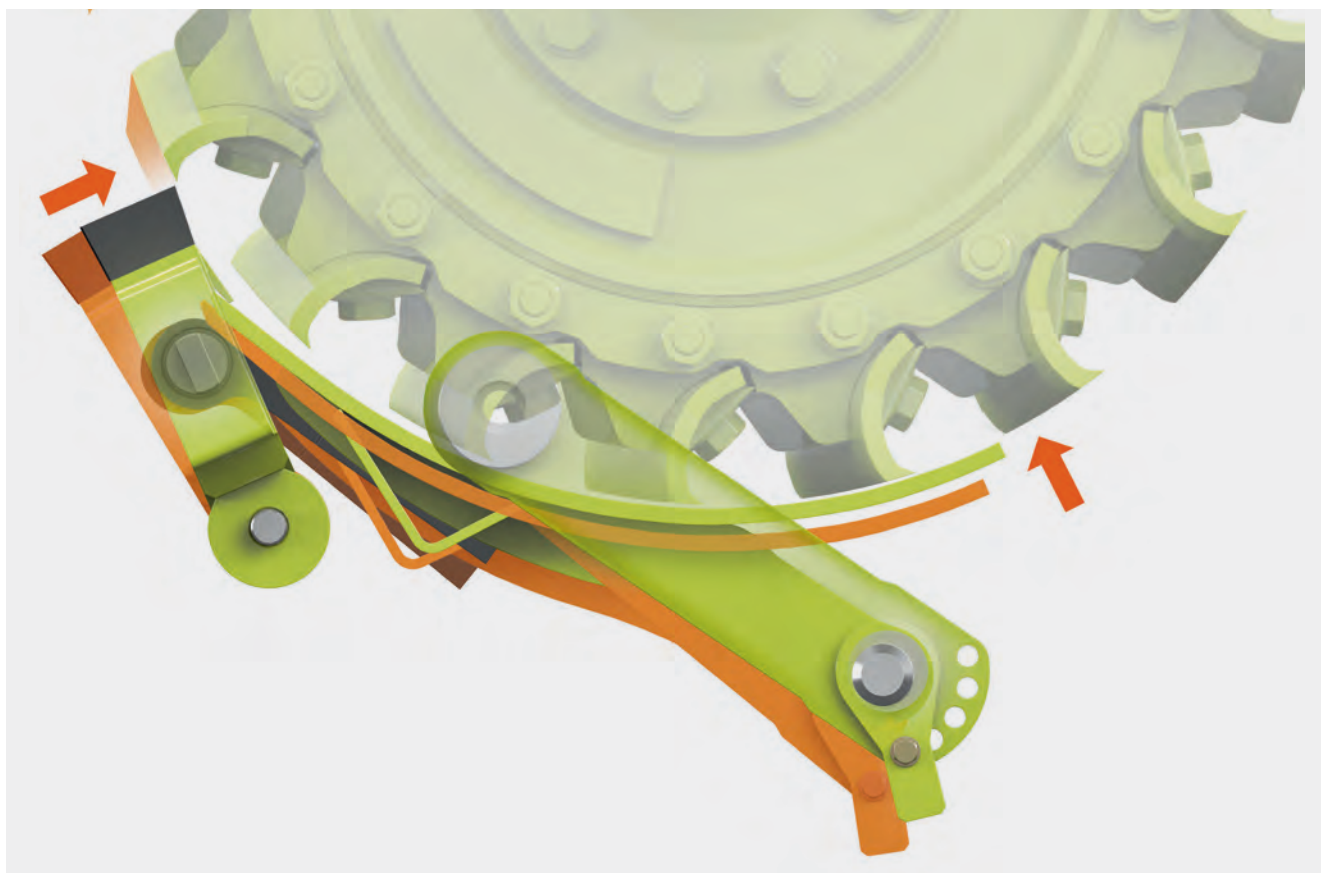

### Automatically adjustable drum concave.

The front of the drum concave is supported on the mounting block while the rear is secured by pivot arms. As soon as the shear bar is adjusted, the drum concave is immediately positioned relative to the chopping cylinder. This arrangement ensures consistent crop delivery during the entire service life of the knives.

- Information on throughput-based knife sharpening
- Precise, even sharpening through exact grindstone guidance
- Outstanding protection from dirt and noise
- Easy adjustment aid for sharpening stone replacement
- Hydraulic clamping system for shear bar allows reliable chopping
- Automatically adjustable drum concave for consistent crop delivery



### Adjustment of drum concave outlet.

The drum concave outlet can be adjusted separately for optimal adaptation to harvest conditions.

# The corncracker. Optimal processing.

## MULTI CROP CRACKER.

The requirements for silage chop length and processing differ widely depending on the individual farm and the purpose for which the silage is to be used. The spectrum extends from extremely short chop lengths of 3.5 mm all the way up to the SHREDLAGE process with lengths greater than 21 mm.



# MULTI CROP CRACKER.

## Three specialists for top-quality results.



1 MCC L                      3 MULTI CROP CRACKER  
2 MCC SHREDLAGE

### MULTI CROP CRACKER.

The key characteristics of the MULTI CROP CRACKER (MCC) are its rugged construction and its extremely well sealed housing. Its great advantage is its flexibility. The outstanding accessibility of the rollers allows them to be replaced by others quickly.

### Choose the correct processor.

The range of kernel processors available for your JAGUAR harvester offer outstanding flexibility in the field:

- Unique product range
- Easy installation and removal thanks to outstanding accessibility
- Extremely rugged design through large bearing units and sealed housing
- High throughput with optimum chop processing
- Outstanding accessibility for maintenance or replacement of rollers
- Consistent, maintenance-free hydraulic belt tensioning for maximum power transmission

 Shredlage in action.  
More information online here:

[shredlage.claas.com](http://shredlage.claas.com)



### MCC L.

The conventional MCC L is equipped with the familiar sawtooth profile and operates as standard with a speed differential of 30%. This system is used successfully for harvesting silage as feed for dairy cattle (long) and for feeders. Other rollers with a different number of teeth are used in crops where there is a greater need for more processed silage. The required degree of silage processing is achieved by increasing the speed differential as well.



Quick removal and installation of the corncracker

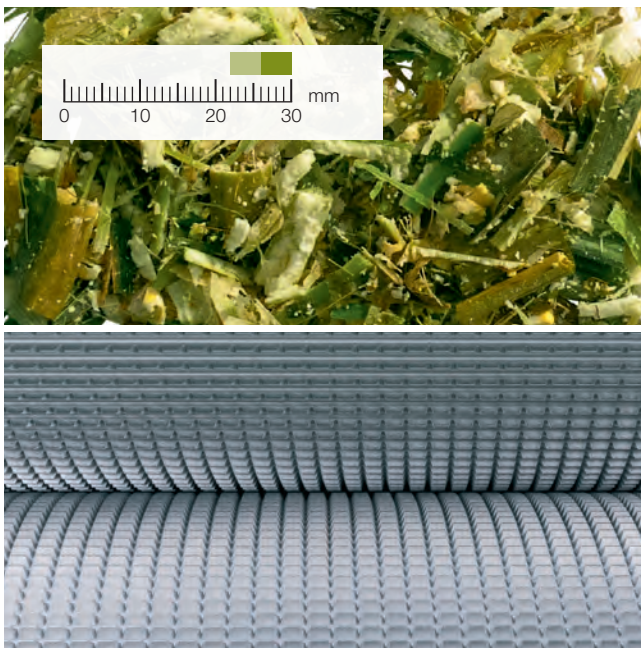

### MCC SHREDLAGE.

SHREDLAGE, technology developed in the US that CLAAS has now acquired, is an intensive corn silage conditioning system in the extremely long chop length range of 21 to 26.5 mm. Operating with a speed differential of 50%, SHREDLAGE rollers have a sawtooth profile with a counter-directional spiral groove cut. MCC SHREDLAGE rollers process the corn kernels thoroughly and chop up cob fragments completely.

Leaves are well shredded and the stalk material in particular is subjected to a lateral effect by the spiral groove which causes the outer hard layer to be rubbed off the stalk. At the same time, the soft inner core is split lengthways.

### SHREDLAGE Beef Study.

In a feedlot study conducted by the University of Nebraska Panhandle Research and Extension, beef cattle fed rations containing SHREDLAGE had greater final body weight, average daily gain, and overall feed efficiency than cattle fed conventionally chopped corn silage. These results suggest that a procedure that SHREDLAGE, as opposed to conventional chopping can be fed at a minimal level in the diet and result in improved performance over traditionally harvested corn silage.

Full statistics are available in The Professional Animal Scientist ([http://www.professionalanimalscientist.org/article/S1080-7446\(15\)30423-X/pdf](http://www.professionalanimalscientist.org/article/S1080-7446(15)30423-X/pdf)) Effect of Corn Shredlage on lactation performance and total tract starch digestibility by dairy cows; L.F. Ferraretto, R.D. Shaver, Department of Dairy Science, University of Wisconsin, Madison.

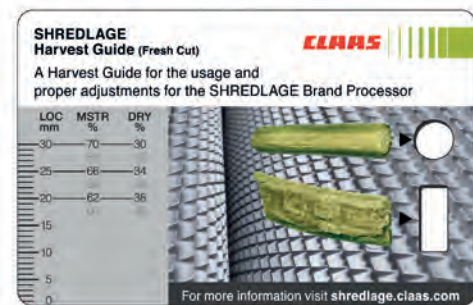

SHREDLAGE Measurement Card  
CLAAS Part Number 02/59 089 0

### SHREDLAGE corn silage.

The intensive processing multiplies the surface of the chopped material many times, resulting in significantly improved bacterial fermentation during ensiling and, above all, during digestion in the cow's rumen. Trials conducted by the University of Wisconsin in Madison showed that SHREDLAGE drastically increases the physical effectiveness of corn silage in the rumen while also improving the availability of the starch contained in all parts of the plant. Furthermore, the rumen-friendly structure of the silage promoted herd health.

SHREDLAGE offers dairy producers other benefits in addition to improved livestock health. As the availability of starch is optimized, it is possible to reduce the quantity of feed concentrate used. It is also possible to limit or even eliminate the use of fiber supplements such as straw, thereby providing further scope for cost savings. Please note that the advice of the responsible feed consultant must always be sought in each individual case.

MULTI CROP CRACKER modes of action	MCC L	MCC SHREDLAGE
Cracker roller gap adjustable for required processing intensity	<input type="checkbox"/>	<input type="checkbox"/>
Number of teeth per roller for crop take-up and kernel size	<input type="checkbox"/>	<input type="checkbox"/>
Roller speed difference for frictional effect	<input type="checkbox"/>	<input type="checkbox"/>
Counter-directional spiral groove for peeling effect	-	<input type="checkbox"/>

Available - Not available

The discharge spout.  
This is how easy precise rear filling can be.





# Crop accelerator and discharge spout. Energy-saving and accessible.

Acceleration the energy-saving way.

The accelerator is ideally positioned in the JAGUAR for optimum performance of its task. The crop flow does not have to negotiate any awkward angles and is centered by the chevron-shaped accelerator paddles. This reduces the energy requirement and wear to the side walls.

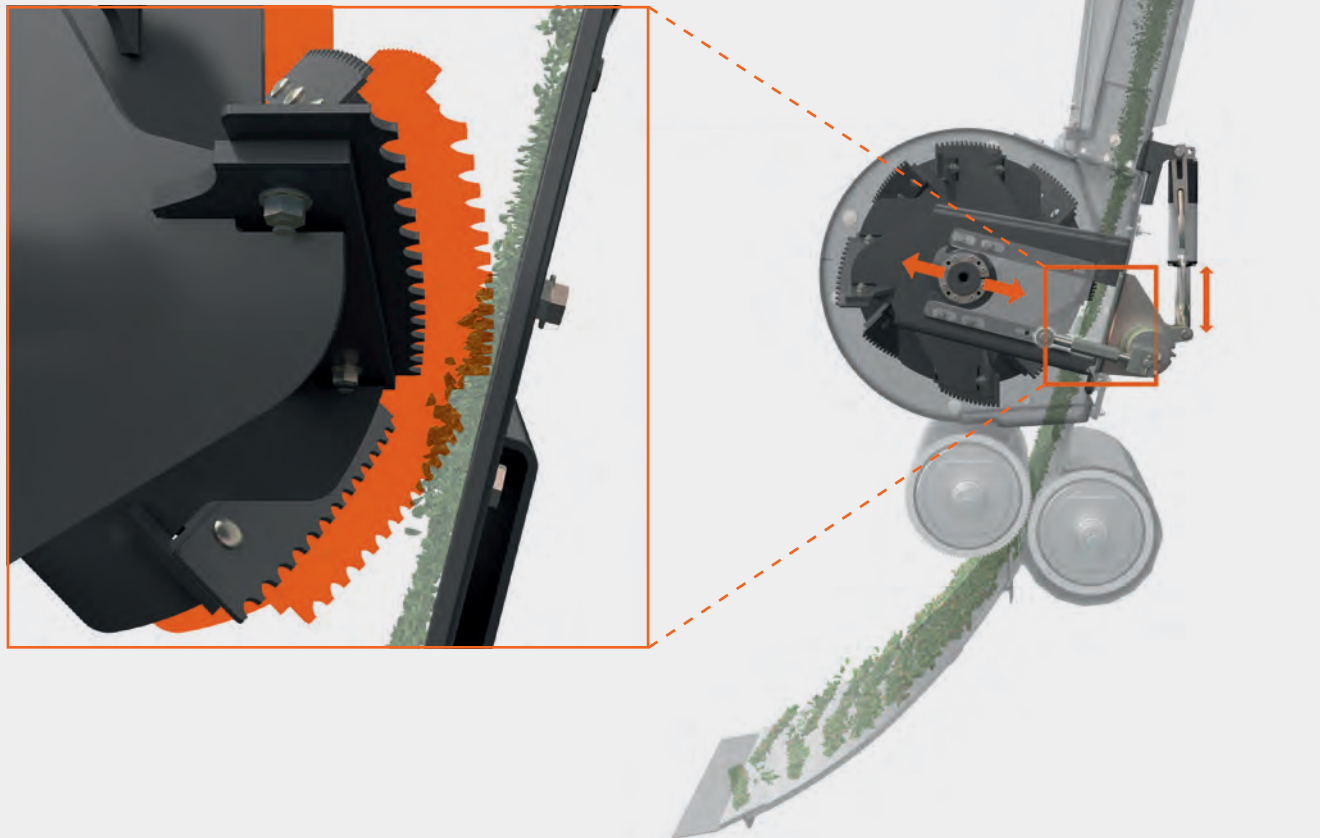

The benefits at a glance.

- Acceleration the energy-saving way
- The discharge spout: modular design
- OPTI FILL: extremely user-friendly



Fast, straightforward removal and installation of the accelerator



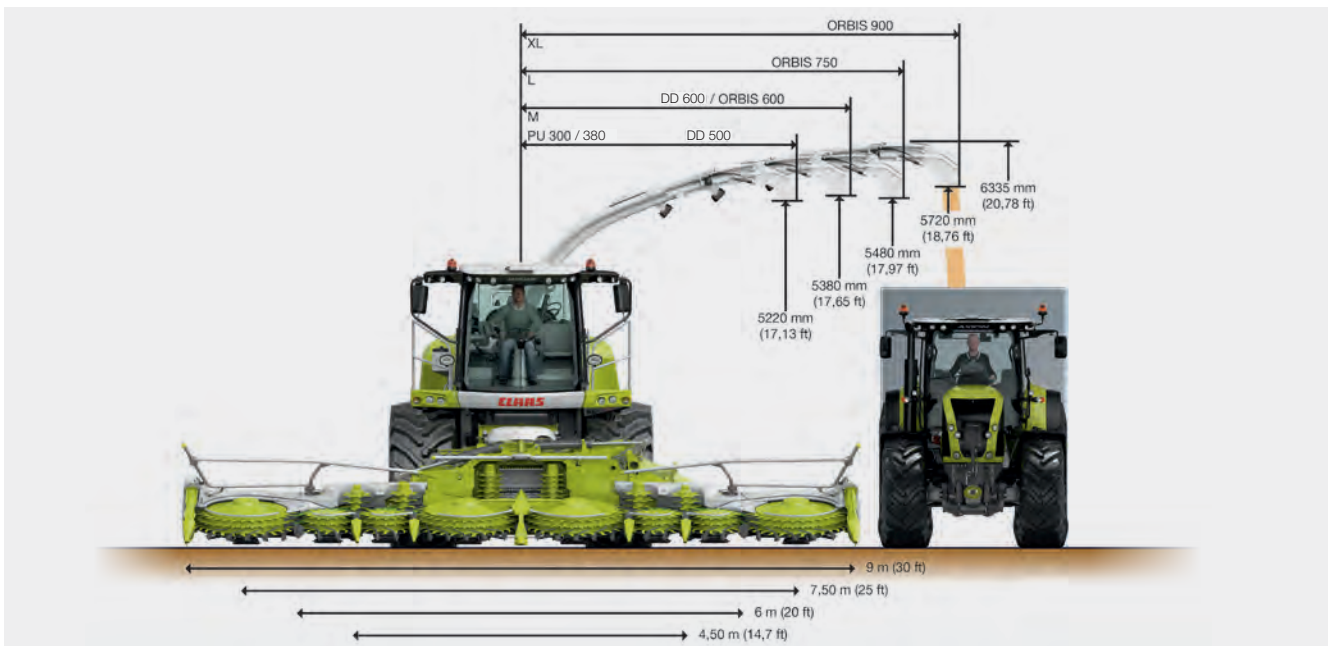

## Low energy required for acceleration.

For heavy crops, the clearance between the accelerator and the rear wall can be increased hydraulically up to 10 mm (hydraulic adjustment optional). This results in a huge reduction in the amount of energy required. If, for example, very dry grass requires a high discharge rate, a very narrow clearance setting can be set. This can even be set up in CEBIS while travelling and then applied automatically at the start of the chopping process.

## The discharge spout. Modular design.

High strength and a low dead weight are the key characteristics of the discharge spout. The highly concentrated crop stream can be directed more reliably, minimizing wasteful losses while the modular design enables the system to be adjusted to different working widths.

Three extensions (M / L / XL) allow working widths of up to 30 ft (9.0 m). The back of the discharge spout is entirely bolted: as a result, the top plates also function as wear plates.

## OPTI FILL: user-friendly. (optional)

The OPTI FILL optimized spout control system allows the transfer process to be managed extremely easily. The wide swivel angle of up to 225° allows an optimal view of the transfer process. When the discharge spout is swivelled, the end flap is adjusted automatically so that the transfer process takes place parallel to the direction of travel. Two permanently programmed spout positions simplify the swivelling process at the end of the field, e.g. when chopping up and down along one edge of a field. Furthermore, the discharge spout can be returned to its parking position automatically at the touch of a button.

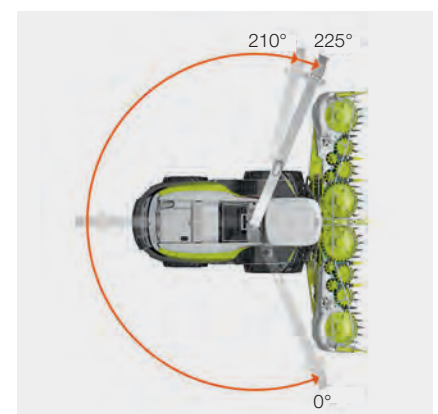

# AUTO FILL. (optional)

Right on target - now also to the rear.



The benefits at a glance.

- AUTO FILL: automatic filling of transport vehicles
- AUTO FILL with rear offloading

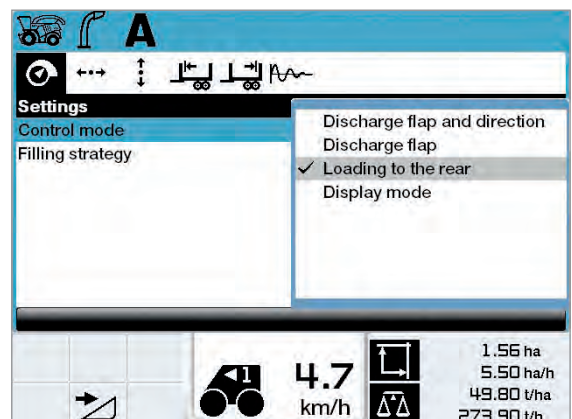



AUTO FILL. Automatic control of the discharge spout. Now also with rear offloading.

AUTO FILL is based on digital 3D image analysis. The system takes care of controlling the discharge spout for you. With AUTO FILL, offloading to the rear is now also automated.

In the past, the AUTO FILL function enabled automated offloading from the forage harvester to a transport vehicle running alongside. With the "Side Rear" AUTO FILL function, automated offloading from the forage harvester is now possible not only from the side but also to a trailer behind the forage harvester – perfect when starting chopping or dividing fields.



In chopping start-up mode, you can easily choose whether you wish offloading to take place to the side or the rear. For automatic filling to the rear, only the desired impact point needs to be specified.

For the AUTO FILL variant, the JAGUAR is equipped with LED swivelling spout lighting. This means that it is also possible to work in the dark while reducing the operator's workload.



# SILAGE TECH™ - Silage quality and technology packaged all in one

The SILAGE TECH™ package is a combination of components that not only make better silage quality, but use the technology to save money with the new innovative insulated inoculant tank to meter the inoculant by the ton or moisture level. The NIR moisture sensor is a highly accurate sensor for measuring moisture. The auto chop length gives proven results by adjusting the length of cut based on moisture. Combining that with industry leading 3rd party GPS systems like Trimble / AG Leader / Field View to give accurate yield maps and steering.

## QUANTIMETER

Yield sensor to generate the yield maps and control inoculant used.

## Automatic chop length

Set the length of cut of the crop dependent on moisture to get precise cut length to improve bunk density and consistent particle size





NIR: (Near Infrared) moisture sensor  
Highly accurate moisture sensor to determine the moisture of the crop

Fuel Consumption Monitoring  
Provide real-time information to help determine any loss in power due to dull knives or plugged filters.

GPS Ready:  
The CANBus interface, monitor bracket, harnesses, and steering valve are all there ready to connect your preferred system for GPS mapping and steering.

Insulated inoculant tank  
Highly insulated inoculant tank that is integrated into yield and moisture sensor - apply the right amount and save money.

# Throughput measurement. Precise every time.

## Throughput measurement with QUANTIMETER (optional).

The deflection of the upper rear precompression roller is recorded. On the basis of this data, together with the intake width and intake speed parameters, the volume flow is measured continuously.

In order to ensure the highest possible degree of accuracy (tons per acre), recalibrating is necessary where there are differences in crop maturity or a change in variety.

## Load counter.

The load counter allows the ability to control the weight loaded into a trailer. Up to 3 different weights can be pre-defined and can be quickly changed via HOTKEY in order to maximize trailer filling and capacity variances between trailers.



## The benefits at a glance.

- Throughput measurement with the QUANTIMETER
- Dry matter measurement with NIR sensor
- 99 gal (375 l) for conventional silage additive dosage
- ACTISILER 37 for concentrate dosage

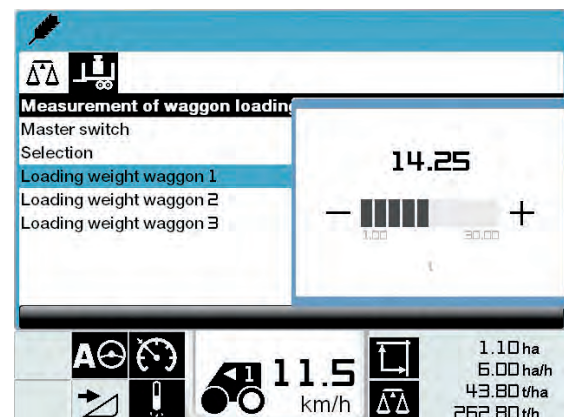

## Dry matter measurement with NIR sensor. (optional)

Continuous dry matter measurement significantly improves the accuracy of the current throughput measurement.

With 20 measurements per second, the near infrared sensor (NIR sensor) attains a very high degree of precision – ideal for the documentation of harvest data for further use.

- Measuring range for grass: 23-70% dry matter
- Measuring range for whole crop silage: 24-60% dry matter
- Measuring range for corn: 20-60% dry matter
- Measuring range for alfalfa (lucerne): 28-35% dry matter

## Using additives to enhance silage quality.

Applying silage additives while chopping has become one of the standard services offered by professional contractors. You can carry up to 99 gal (375 l) of fluid in the standard-fit additive tank which is easy to fill. The mixed additive is sprayed straight into the crop at the accelerator.

- Tank capacity of 99 gal (375 l)
- Flexible filling and cleaning facility
- Dosage from 8 gal/h to 105 gal/h (30 l/h to 400 l/h)
- Throughput based metering from 0.13 gal/t to 0.5 gal/t (0.5 l/t to 2 l/t) (up to 200 t/h)
- Dosage on basis of dry matter possible
- Sight tube for external level indication

The dosage is controlled via CEBIS. Furthermore, the system informs the driver about the fill level of the tanks.

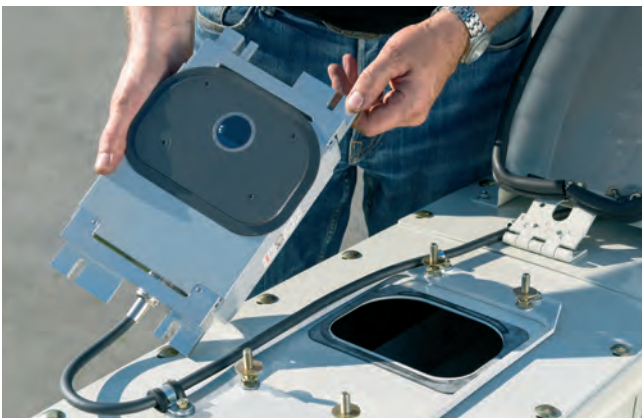

## ACTISILER 37 for precise dosage. (optional)

There is currently a trend towards a reduced quantity and a higher concentration. The new, optional ACTISILER 37 has been designed specifically to achieve this high-precision task with a precisely dosed quantity of concentrated lactic acid bacteria solution. The control of the dosage, the record of how much you apply and the monitoring functions are all easily managed using CEBIS.

- Separate 9.75 gal (37 l) tank for highly concentrated products
- Dosage is controlled via CEBIS:
  - constant: 6.75 oz/h to 2 gal/h (200 ml/h to 7500 ml/h);
  - throughput-based: 0.33 oz/t to 1 oz/t (10 ml/t to 30 ml/t)
- Dosage on basis of dry matter possible

Both systems can also be used simultaneously.



# PREMIUM LINE. (optional) Extra-hard, highly wear-resistant.

Now also available ex-factory.

For demanding harvesting conditions PREMIUM LINE offers specially coated and highly wear-resistant parts. The extremely long service life of these parts increases their operating hours significantly. And that saves you time and money.







- 1 Feed roller wear bar
- 2 Wear plate, at right and left at front of intake
- 3 Wear plate, at right and left at rear of intake
- 4 Drum roller stripper bar
- 5 PREMIUM LINE shear bar
- 6 Wedge behind shear bar
- 7 Drum bottom concave
- 8 Wear plates, transition plate on left and right side walls
- 9 Sharpening stone
- 10 Grass chute rear wall
- 11 Chromed corncracker rollers
- 12 Accelerator paddles
- 13 Accelerator housing, two-part
- 14 Accelerator housing, left and right sides
- 15 Discharge tower, front and rear
- 16 Spout rotation ring
- 17 All spout wear plates

# The JAGUAR headers. Effective and durable.

- Swath collection with the PICK UP
- Whole crop harvesting with the DIRECT DISC
- Corn harvesting with ORBIS or RU





NEW

PICK UP.  
A thorough job, perfectly controlled.



### PICK UP. Crop flow adjustment.

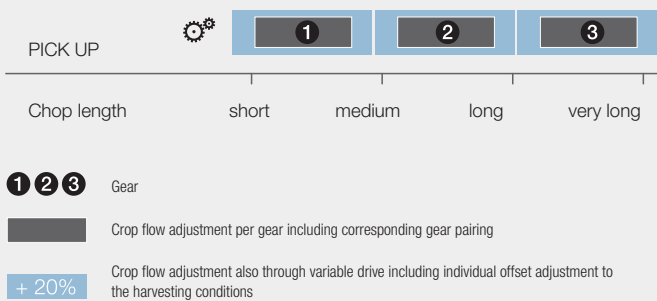

## PICK UP 380 and 300. Robust and flexible.

The trend towards more powerful forage harvesters and higher yields means that features such as clean crop intake, robust technology and straightforward operation are becoming more important.

The PICK UP 300 and 380 with respective working widths of 10 ft and 12.5 ft (3.0 m and 3.8 m) meet these requirements with a host of impressive details:

- Attachments can be easily attached and removed by quick-connect coupler and central locking lever on the left-hand side
- Small-diameter rake with five rows of tines for clean crop intake
- Large auger diameter designed for optimal crop transfer even at high throughput
- Excellent ground-contour following is achieved with a swivelling frame and folding caster guide wheels (can be set without tools) – wear parts can be replaced easily after being subjected to extreme wear
- Rugged drive line with easy-to-operate, three-speed gearbox (optional)
- The optional variable drive of the JAGUAR ensures that the speed of the intake auger is automatically matched ideally to the set chop length; furthermore, the speed can be set manually for different harvesting conditions
- The optional 3 speed gearbox gives the operator a wider range in speeds for changing crop conditions
- ACTIVE CONTOUR standard for better ground following on hilly terrain, better turf protection, and reduced machine wear.
- NEW: Hydraulic folding wheels.



DIRECT DISC.  
Mowing, chopping, harvesting. Job done.



Powerful drives with optimal protection



Side knives for DIRECT DISC 600 / 500



Quick blade change



DIRECT DISC 600 / 500,  
suitable for crop heights up to 13 ft (4.0 m) (sorghum),  
with large intake auger



## Whole-plant cutting with the DIRECT DISC.

Whether you're intending to use milk ripe plants for high-grade animal feed or as biomass for energy production, this header means you can mow and chop in a single pass.

### **DIRECT DISC 600 and 500 model series.**

The plants are mowed with the new MAX CUT mower bar which ensures very even stubble thanks to the mowing discs being positioned well forward. The crop is fed straight to the forage harvester by a powerful intake auger with significantly increased diameter.

The new model series is notable in particular for its ability to handle very tall plants, such as sorghum (growing to heights of up to 13.ft (4.0 m)). CLAAS offers side knives for use in severely intertwined crops.

## Simple, convenient, variable.

- Simply couple and lock with the quick coupling
- Delayed activation of paddle, auger and the mower unit means that DIRECT DISC can also be used under full load
- Three different speeds of paddle and auger for a smooth crop flow and optimal chopping quality
- Proven DISCO mowing bar for high chopping output and neat work quality.
- Reduced downtime, thanks to quick blade change
- Perfect adaptation to harvesting conditions with hydraulically height-adjustable paddle roller
- Easy access to conveying elements through large service opening
- Excellent ground adaptation through mechanical lateral balance and skid-assisted guidance with ground pressure control
- Side knives optionally available
- NEW: Hydraulic push bar

# ORBIS. Smooth-running and variable.



## ORBIS. Row-independent harvesting.

The ORBIS row-independent corn header combines experience gained in practical use all over the world with innovative ideas relating to the design and drive.

The optional variable drive of the JAGUAR ensures that the speed of the intake auger is automatically matched ideally to the set chop length. Furthermore, the speed can be set manually for different harvesting conditions.

- Quick coupler enables easy frictional connection with JAGUAR
- Working widths of 20 ft, 25 ft, or 30 ft (6 m, 7.5 m or 9 m)
- Optimal crop flow: consistent chopping quality depends on a longitudinal plant feed
- Light-running drive: low starting torque and low power requirement, so that it can be engaged and reversed under power
- Additional equipment variants for ideal matching to different harvest conditions
- Optimal ground contour following: suspended-frame geometry for ideal lateral balance optionally available with AUTO CONTOUR

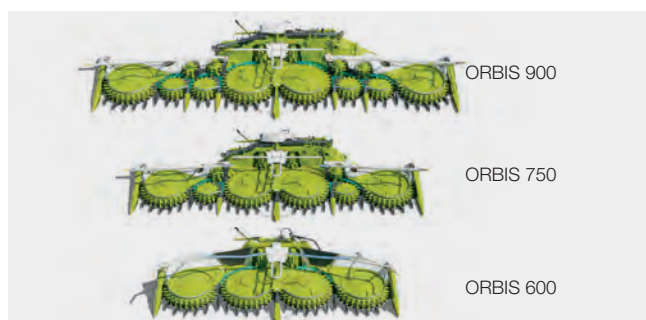





AUTO CONTOUR. Outstanding ground-contour tracking. (standard on ORBIS 900 only)

ORBIS has a suspended frame which is attached to the main frame by three arms. The arm geometry enables an ideal lateral balance. The mechanical lateral balance system acts in response to light ground pressure (CONTOUR) on the skids as ORBIS moves over the field.

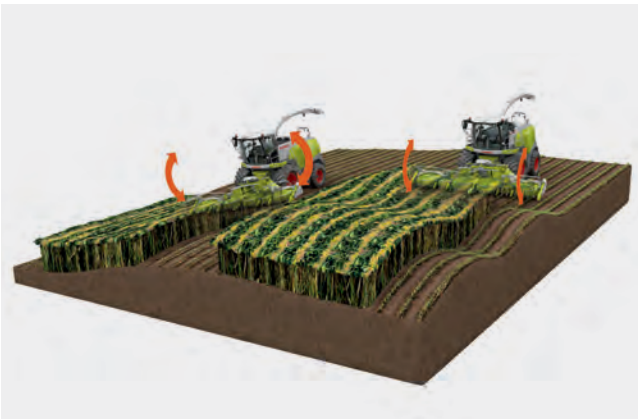

AUTO CONTOUR provides automatic lateral balance: input from sensor skids at left and right enables ORBIS to accurately follow the ground topography.

- Minimum bounce, even on slopes
- Mechanical lateral balance with ground pressure control (CONTOUR) on contact with ground
- Automatic lateral balance with AUTO CONTOUR by means of outer sensor skids

CLAAS AUTO PILOT. (optional)



Two sensor skids each gauge two rows of corn. The signals generated by these sensors are translated into appropriate steering impulses. The steering is automatic up to a speed of 7.5 mph (12 km/h). Twin-row sensing allows automatic steering in row widths of 14.76" to 31.5" (37.5 cm to 80 cm).

- Maximum operator stress relief
- Increased area output
- Reliable row guidance, even where there are gaps in the crop
- Maintenance-free and low-wear technology

# RU 450. Proven performer.



## The benefits at a glance.

- RU 450 with three large cutting and transport discs
- Counterdirectional rotation of the knife discs
- Self-sharpening effect

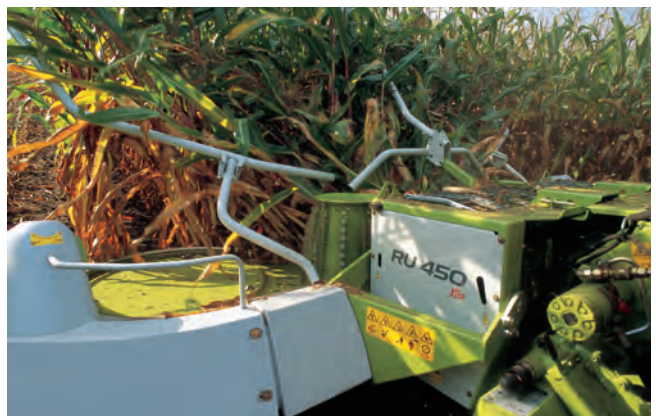

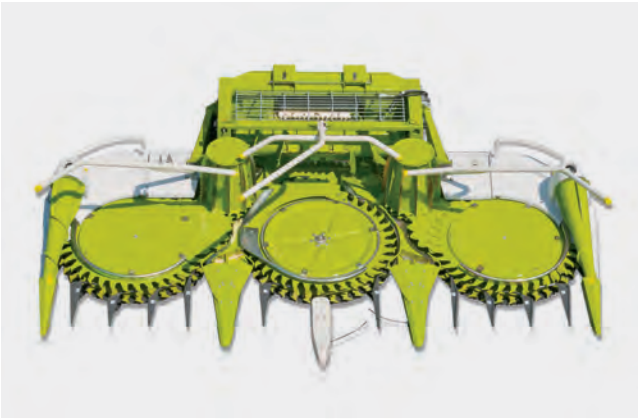

RU 450: up to 14.75 ft (4.5 m) working width.

The crop flow concept is based on three large cutting and transport discs rotating counterdirectionally to each other. The cut surfaces of the plants rest on the blade and create a self-sharpening effect as they are fed in.

An aggressive crop flow is ensured by the intake auger whose speed can be optimized in line with the set chopping length. The simple construction makes for ruggedness and reliability and has proven itself extremely well.



- Low power requirement
- Reliable crop transport under all conditions
- Can be switched on and reversed under full load
- Adapts easily with quick coupler

Reliable with self-sharpening effect.

High quality work through reliable plant transport and even stubble: thanks to the combination of the aggressive transport disc and the scraper disc, the RU 450 enables active plant transport under all conditions.



This design is made all the more effective by the counterdirectional knife disc. After cutting, the corn stalks are transported to the intake auger while standing on the knife disc. The friction created by transporting the standing corn stalks on the knife disc produces a self-sharpening effect.

# ORBIS protection against wear.

Protection against wear as standard.

- 1 Transmission guard
- 2 Guide strips
- 3 Scrapers positioned under the cutting discs to improve operational reliability in difficult conditions



## PREMIUM LINE protection against wear. (standard)

- 1** PREMIUM LINE crop flow: feed drums with special hard coating. Welded interior guide strips. Exterior guide strips made from steel.
- 2** PREMIUM LINE skids: additional skids as protection against wear
- 3** PREMIUM LINE knife guards: additional wear elements to protect the large cutting discs and knives

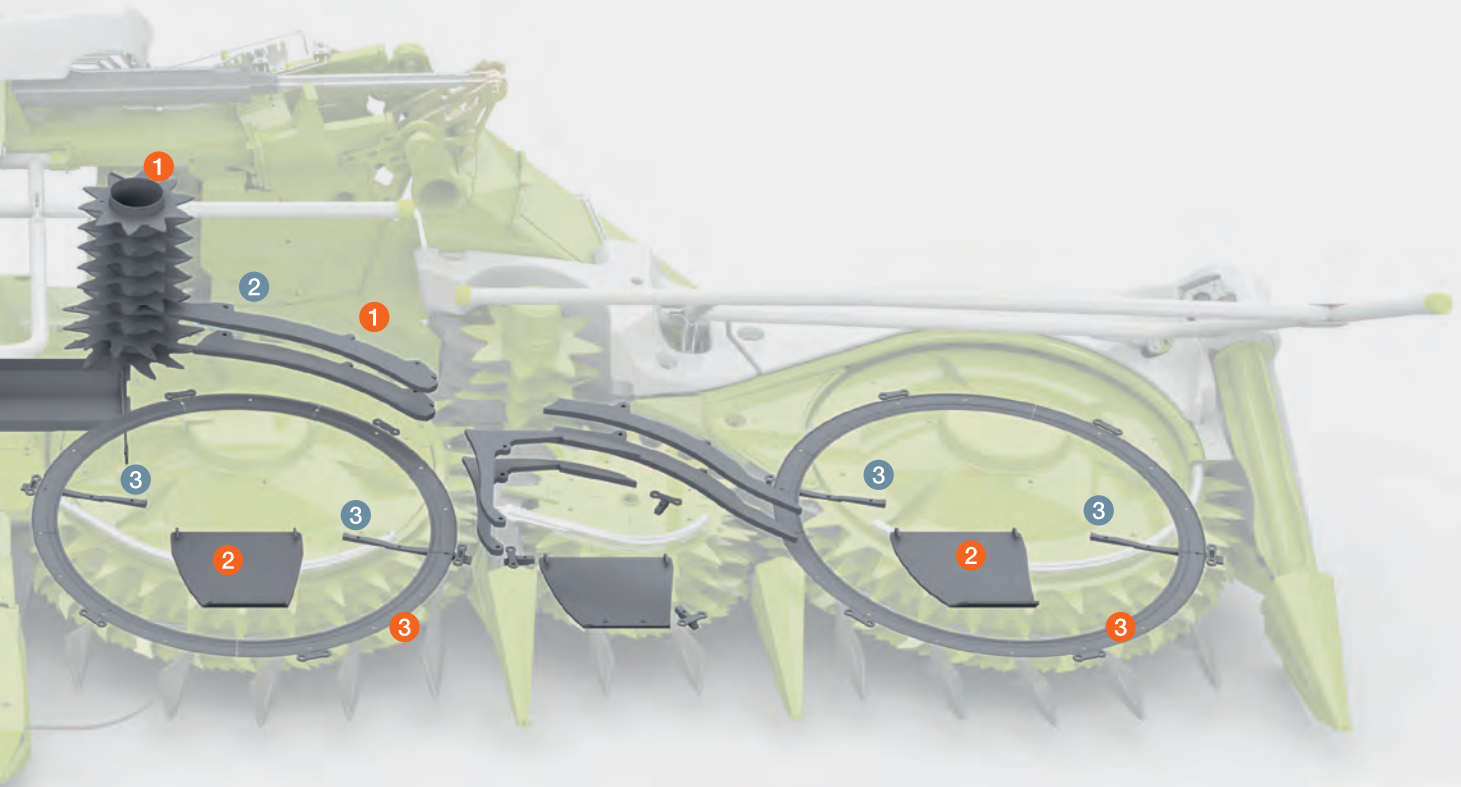

The maintenance concept.  
Quick and straightforward.



The benefits at a glance.

- Numerous work lights turn night into day
- QUICK ACCESS: quick inspection of chopping unit
- Maintenance-free braking system
- Long-life hydraulic oil



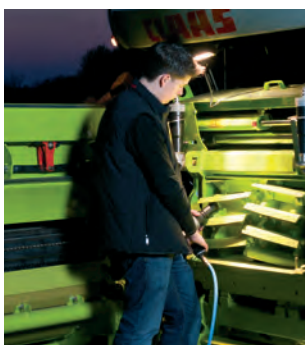

Magnetic hand lamp



Step lighting



QUICK ACCESS



Quick removal of accelerator



Easy access



Air filter change without tools



4.2 gal (16 l) supply of grease



Long-life hydraulic oil (standard)

## Save time, energy and trouble.

- Work lights under side and rear panels as well as in storage compartment for a clear view (optional)
- Hand lamp with magnetic base for front illumination
- Afterglow function for work lights after ignition is switched off
- Steps illuminated to allow safe exit from cab in the dark
- QUICK ACCESS lets you inspect the chopping unit in a matter of minutes
- The spacious storage compartment ensures that all tools and accessories are within easy reach
- 4.2 gal (16 l) supply of grease where automatic central lubrication is fitted, sufficient for about 280 hours of operation with Corncracker (approx. 500 operating hours without Corncracker fitted) (standard)
- Filled as standard with Shell Alvania RL3 / K3 high-performance antifriction bearing grease for very high temperature stability, low friction losses and a long service life
- Large side panels allow unrestricted access to the cooling system, the corncracker and the accelerator
- Intake air filter can be accessed very easily in the dust-free zone, maximized service intervals
- Maintenance-free braking system
- If maintenance is needed, the accelerator can be removed by two people in the span of one hour
- Standard: biodegradable hydraulic oil, AGRIHYD XTREME 46 long-life hydraulic oil. The standard oil change interval increases from 1000 hours to at least 3000 h. The oil is notable for its short warm-up time, very high temperature stability, optimal lubrication characteristics and extremely high viscosity.

# Whatever it takes – CLAAS Service & Parts.



## Your needs matter.

You can always rely on us: we'll be there whenever you need us – everywhere, quickly and reliably, around the clock if necessary, with precisely the solution that your machine or business requires.

## Reliability can be planned.

With our service products, you can increase your machine reliability, minimize your risk of breakdowns, and budget with confidence. CLAAS MAXI CARE offers planned reliability for your machine.



## Always up to date.

CLAAS dealer service teams are trained by CLAAS and equipped with the all-important special tools and diagnostic systems to meet all your expectations with regard to expertise and reliability.

## Problem solving by remote diagnostics: CLAAS TELEMATICS.

CLAAS TELEMATICS on your machine brings two important advantages: fast assistance from CLAAS service technicians and a more profitable operation, thanks to wireless networking. We can be there, on the spot, to solve your problem – even when you can't see us.

## ON YOUR FARM PARTS.

CLAAS ON YOUR FARM PARTS allows you to customize a selection of parts on your farm in order to get you back up and running in minimal time. Buy now – pay after the harvest – it's that simple. Ask your participating dealer for details.





**ORIGINAL** parts and accessories.

Specially matched to your machine: precision-manufactured parts, high-quality consumables and useful accessories. We will supply exactly the right solution from our comprehensive product range to ensure that your machine is 100% reliable.

Worldwide coverage from Columbus, Regina, and Hamm.

The CLAAS of America Parts Logistics Centers in Columbus, Indiana and Regina, Saskatchewan, provide world-class parts support throughout North America for all CLAAS products. Supported by the CLAAS worldwide spare parts depot in Hamm, Germany, we provide the CLAAS dealer network with reliable, consistent parts availability and industry leading responsiveness. Your local CLAAS dealer can supply the right parts solution for your business to maximize machine uptime.



The CLAAS Parts Logistics Center in Columbus, Indiana, stocks more than 36,000 part numbers in a warehouse area of over 165,000 sq ft.



The CLAAS Parts Logistics Center in Regina Saskatchewan, stocks more than 14,000 part numbers in a warehouse area of over 33,000 sq ft.

# JAGUAR.

## The only choice.

JAGUAR		980	970	960	950	940	930
<b>Engine</b>							
Manufacturer		MAN	MAN	Mercedes-Benz	Mercedes-Benz	Mercedes-Benz	Mercedes-Benz
Type		D2862	D2862	OM 473 LA	OM 473 LA	OM 471 LA	OM 471 LA
Cylinders		V12	V12	S6	S6	S6	S6
Displacement	l	24.24	24.24	15.6	15.6	12.8	12.8
Engine output at working speed of 1700 rpm (ECE R 120)	hp / kW	884 / 650	800 / 588	626 / 460	585 / 430	516 / 380	462 / 340
Fuel tank with auxiliary tank	gal (l)	356 (1350)	356 (1350)	356 (1350)	356 (1350)	356 (1350)	356 (1350)
Urea tank	gal (l)	34.3 (130)	34.3 (130)	34.3 (130)	34.3 (130)	34.3 (130)	34.3 (130)
Fuel consumption measurement		○	○	○	○	○	○
DYNAMIC POWER		○	○	○	○	○	–
<b>Running gear</b>							
Traction drive: 2-speed OVERDRIVE transmission, automatic (hydrostatic)		●	●	●	●	●	●
Differential lock		○	○	○	○	○	○
Tire pressure adjustment system - drive axle		○	○	○	○	○	○
Tire pressure adjustment system - drive and steering axle		○	○	○	○	○	○
Steering axle, 3 x adjustment, 8.25, 9.75, 10.25 ft (2510, 2970, 3130 mm)		○	○	○	○	○	○
POWER TRAC driven steering axle		○	○	○	○	○	○
Water / silage additive tank content, 99 gal (375 l)		●	●	●	●	●	●
ACTISILER 37 content, highly concentrated, 5 gal (20 l)	l	○	○	○	○	○	○
<b>Headers</b>							
Corn header ORBIS / RU, rows / width	rows / ft	12 / 30 (9)	12 / 30 (9)	12 / 30 (9)	10 / 25 (7.5)	10 / 25 (7.5)	8 / 20 (6)
	(m)	10 / 25 (7.5)	10 / 25 (7.5)	10 / 25 (7.5)	8 / 20 (6)	8 / 20 (6)	6 / 15 (4.5)
		6 / 15 (4.5)	6 / 15 (4.5)	8 / 20 (6)	6 / 15 (4.5)	6 / 15 (4.5)	
PICK UP, working width	ft (m)	12.5 (3.6)	12.5 (3.6)	12.5 (3.6)	12.5 (3.6)	12.5 (3.6)	12.5 (3.6)
		10 (2.6)	10 (2.6)	10 (2.6)	10 (2.6)	10 (2.6)	10 (2.6)
DIRECT DISC, working width	ft (m)	19.7 (5.96)	19.7 (5.96)	19.7 (5.96)	19.7 (5.96)	19.7 (5.96)	19.7 (5.96)
		17 (5.13)	17 (5.13)	17 (5.13)	17 (5.13)	17 (5.13)	17 (5.13)
<b>Header drive</b>							
Standard		●	●	●	●	●	●
Variable		○	○	○	○	○	○
<b>Intake</b>							
Width, 28.75 in (730 mm)		●	●	●	●	●	●
Intake and precompression rollers, no. 4		●	●	●	●	●	●
COMFORT CUT chop length adjustment, infinitely variable		●	●	●	●	●	●
<b>knife drum</b>							
Width, 29.5 in (750 mm)		●	●	●	●	●	●
Diameter, 24.75 in (630 mm)		●	●	●	●	●	●
<b>Knife configuration options</b>							
V-MAX 20		V20 / 2 x 10	V20 / 2 x 10	V20 / 2 x 10	V20 / 2 x 10	V20 / 2 x 10	V20 / 2 x 10
		V10 / 2 x 5	V10 / 2 x 5	V10 / 2 x 5	V10 / 2 x 5	V10 / 2 x 5	V10 / 2 x 5
V-MAX 24 extended		V24 / 2 x 12	V24 / 2 x 12	V24 / 2 x 12	V24 / 2 x 12	V24 / 2 x 12	V24 / 2 x 12
		V12 / 2 x 6	V12 / 2 x 6	V12 / 2 x 6	V12 / 2 x 6	V12 / 2 x 6	V12 / 2 x 6
V-MAX 28 extended		V28 / 2 x 14	V28 / 2 x 14	V28 / 2 x 14	V28 / 2 x 14	V28 / 2 x 14	V28 / 2 x 14
		V14 / 2 x 7	V14 / 2 x 7	V14 / 2 x 7	V14 / 2 x 7	V14 / 2 x 7	V14 / 2 x 7
V-MAX 36 extended		V36 / 2 x 18	V36 / 2 x 18	V36 / 2 x 18	V36 / 2 x 18	V36 / 2 x 18	V36 / 2 x 18
		V18 / 2 x 9	V18 / 2 x 9	V18 / 2 x 9	V18 / 2 x 9	V18 / 2 x 9	V18 / 2 x 9
		V12 / 2 x 6	V12 / 2 x 6	V12 / 2 x 6	V12 / 2 x 6	V12 / 2 x 6	V12 / 2 x 6
Automatic knife sharpening from cab		●	●	●	●	●	●
Shear bar adjusted automatically from the cab		●	●	●	●	●	●
<b>MULTI CROP CRACKER</b>							
MCC CLASSIC, L, ø 9.8 in (250 mm)		○	○	○	○	○	○
MCC SHREDLAGE, L, ø 9.8 in (250 mm)		○	○	○	○	○	○

● Standard ○ Optional – Not available

JAGUAR		980	970	960	950	940	930
<b>Crop accelerator</b>							
Width 680 mm		●	●	●	●	●	●
Diameter 540 mm		●	●	●	●	●	●
Gap setting 2-10 mm		○	○	○	○	○	○
<b>Discharge spout</b>							
Breakback protection		●	●	●	●	●	●
Swivel angle, standard, 210°		●	●	●	●	●	●
Swivel angle with OPTI FILL / AUTO FILL, 225°		○	○	○	○	○	○
Discharge spout S		●	●	●	●	●	●
Extension M (ORBIS 600), 1 x 750 mm		○	○	○	○	○	○
Extension L (ORBIS 750), 2 x 750 mm		○	○	○	○	○	○
Extension XL (ORBIS 900), 3 x 750 mm		○	○	○	○	○	○
<b>EASY</b>							
OPTI FILL, optimized spout control		○	○	○	○	○	○
AUTO FILL, automatic trailer filling		○	○	○	○	○	○
STOP ROCK stone detector		○	○	○	○	○	○
QUANTIMETER throughput measurement		○	○	○	○	○	○
QUANTIMETER + continuous moisture measurement		○	○	○	○	○	○
Yield mapping		○	○	○	○	○	○
TELEMATICS		○	○	○	○	○	○
AUTO PILOT central sensors (corn)		○	○	○	○	○	○
CAM PILOT swath recognition (grass)		○	○	○	○	○	○
GPS PILOT		○	○	○	○	○	○
CRUISE PILOT		○	○	○	○	○	○
<b>Maintenance</b>							
Central lubrication, 16-l grease reservoir		●	●	●	●	●	●
Service lighting		○	○	○	○	○	○
<b>VISTA CAB</b>							
A / C MATIC air conditioning		●	●	●	●	●	●
CEBIS color monitor		●	●	●	●	●	●
Printer		○	○	○	○	○	○
Comfort seat		●	●	●	●	●	●
Swiveling seat		○	○	○	○	○	○
Leather seat, ventilated, heated		○	○	○	○	○	○
Trainer seat		●	●	●	●	●	●
<b>Tires</b>							
<b>Drive axle, transport width acc. to tire size up to 1950 mm diam.</b>							
IF 680/85 R 32 179 A8	in (mm)	123.25 (3130)	123.25 (3130)	123.25 (3130)	123.25 (3130)	123.25 (3130)	123.25 (3130)
710/70 R 38 175 D TR	in (mm)	124.75 (3172)	124.75 (3172)	124.75 (3172)	124.75 (3172)	124.75 (3172)	124.75 (3172)
710/70 R 38 171 D FS	in (mm)	126.3 (3209)	126.3 (3209)	126.3 (3209)	126.3 (3209)	126.3 (3209)	126.3 (3209)
900/60 R 32 176 A8 MI	in (mm)	137.5 (3490)	137.5 (3490)	137.5 (3490)	137.5 (3490)	137.5 (3490)	137.5 (3490)
900/60 R 32 176 A8 TR	in (mm)	137.5 (3490)	137.5 (3490)	137.5 (3490)	137.5 (3490)	137.5 (3490)	137.5 (3490)
520/85 R42 DUAL Drive Tires	in (mm)	201.9 (5127)	201.9 (5127)	201.9 (5127)	201.9 (5127)	201.9 (5127)	201.9 (5127)
<b>Steering axle, transport width by tire size</b>							
VF 520/80 R 26	in (mm)	115 (2920)	115 (2920)	115 (2920)	115 (2920)	115 (2920)	115 (2920)
540/65 R 30	in (mm)	116.5 (2960)	116.5 (2960)	116.5 (2960)	116.5 (2960)	116.5 (2960)	116.5 (2960)
600/65 R 28 TR	in (mm)	120 (3050)	120 (3050)	120 (3050)	120 (3050)	120 (3050)	120 (3050)
<b>Basic Machine Transport Specifications</b>							
Working length	ft (mm)	21.25 (6495)	21.25 (6495)	21.25 (6495)	21.25 (6495)	21.25 (6495)	21.25 (6495)
Working height with discharge spout extension XL	ft (mm)	20.75 (6335)	20.75 (6335)	20.75 (6335)	20.75 (6335)	20.75 (6335)	20.75 (6335)
Transport height	ft (mm)	11.4 (3945)	11.4 (3945)	11.4 (3945)	11.4 (3945)	11.4 (3945)	11.4 (3945)
Transport length with discharge spout extension XL	ft (mm)	28.1 (8590)	28.1 (8590)	28.1 (8590)	28.1 (8590)	28.1 (8590)	28.1 (8590)
Weight on standard tires without front attachment	kg	30,420 (13,800)	29,540 (13,400)	28,990 (13,150)	28,990 (13,150)	28,110 (12,750)	28,110 (12,750)

CLAAS continually develops its products to meet customer needs. This means that all products are subject to change without notice. All descriptions and specifications in this brochure should be considered approximate and may include optional equipment that is not part of the standard specifications. This brochure is designed for worldwide use. Please refer to your nearest CLAAS dealer and their price list for local specification details. Some protective panels may have been removed for photographic purposes in order to present the function clearly. To avoid any risk of danger, never remove these protective panels yourself. In this respect, please refer to the relevant instructions in the operator's manual.

All technical specifications relating to engines are based on the European emission regulation standards: Stage. Any reference to the Tier standards in this document is intended solely for information purposes and ease of understanding. It does not imply approval for regions in which emissions are regulated by Tier.



Ensuring a better **harvest.**

CLAAS of America Inc.  
8401 S 132nd Street  
Omaha, NE 68138  
Phone +1 (402) 861-1000  
Fax +1 (402) 861-1003  
[www.claas.com](http://www.claas.com)

CL99881039 / 7/2018