

**The new  
generation**



# BiG Pack

Big Balers







# BiG Pack

KRONE BiG Pack –  
A new generation of balers.

### The additive dispenser

The 5th generation BiG Pack models are available with an integral dispenser for applying additives that improve fermentation or conservation of the crop.

Page 42

### Bale chamber

All models gain the much longer baling chamber from the 1290 HDP for firmer, tighter and heavier bales.

Page 20

### Lights

In addition to the modern full LED light specification, KRONE also offers various LED work light packages to suit individual needs

Page 36

### KRONE PowerClean

A brand new hydraulic knotter fan cleans the knotter permanently. The best part of this is that the air flow is also directed to the areas behind the twine boxes cleaning further areas of the machine.

Page 24

### The cutting system

The VariCut system offers buyers the flexibility to choose between two blade cassettes with up to 26 or 51 blades each

Page 10



### Options

Further options to boost increase operator comfort

Page 44

### Axle

The new BPW tandem axles and a choice of tyre options ensure stable rides behind the tractor

Page 30

Even after more than 25 years of big baler production in Spelle, there is no sign of any let-up in the sheer innovative strength of the KRONE engineering team, as is evident from the new series of BiG Pack balers. Over several years of intensive development, they have come up with a completely new generation of BiG Pack balers which incorporate many well-known technologies and, above all, offer a significant increase in comfort. Almost all of the existing features have been upgraded and adapted to user requirements. How exactly, you will learn on the following pages.

#### Electronics

The new BPW tandem axles and a choice of tyre options ensure stable rides behind the tractor

Page 32

#### Active pick-up

The camless Active pick-up from KRONE is now available as a hydraulic option

Page 8

#### Flywheel

The well-proven and convenient driveline without shear pins

Page 18

#### Twine boxes

A new and most functional approach – learn more about the new twine boxes

Page 23 / 34

#### Twines

Original KRONE twine gives peace of mind

Page 48

#### VFS packers

Tried and tested just got better! Read more on the updated VFS variable filling system

Page 16

#### Drawbar

Choice of hitch options to suit all requirements across the globe

Page 30





# BiG Pack – The fifth generation

More comfort, more productivity

- **BiG Pack 1270 (VC, MultiBale):**  
120 x 70 cm chamber, with or without cutting system / MultiBale system
- **BiG Pack 1290 (VC):**  
120 x 90 cm chamber, with or without cutting system
- **BiG Pack 1290 HDP (VC):**  
120 x 90 cm chamber; High Density baler with or without cutting system

More than 25 years of experience and expertise has been built into the KRONE big balers. The Variable Filling System, the unique MultiBale system and the camless EasyFlow pick-up with mechanical-drive rotor (Active Pick-up) are the landmark features that have won international recognition and that underpin the success of BiG Pack.

Based on this design, the new generation of BiG Pack models is now being launched.



## **BiG Pack 1270 (VC, MultiBale)**

The BiG Pack 1270 offers a 120 x 70 cm chamber – a very popular size especially among farmers. Its patented MultiBale system forms one big bale from up to nine individual packs. The big packs are easier to collect in the field and the smaller packs are easy to handle and distribute in the barn. Also, the new BiG Pack 1270 produces much higher-density bales than its predecessor, a boon for maximising transport and storage efficiencies.



## **BiG Pack 1290 (VC)**

The KRONE BiG Pack 1290 (VC) has the 120 x 90 cm chamber which is the most popular chamber size on the international market – not only because it makes very economic use of the twine but also because these bales stack very well. The new version has a much longer chamber and this has a positive effect on the shape of the bales. In addition, the model is now also available with the 51-blade VariCut cutting system.



## **BiG Pack 1290 HDP (VC)**

Churning out more than 100 straw bales per hour at bale weights of up to 500 kg, this is the benchmark machine in terms of performance and density. Looking for efficient long-distance haulage of straw and hay bales? Then HDP technology from KRONE is for you.





## The new generation BiG Pack models (by chamber size)

BiG Pack 1270 BiG Pack 1270 VC	120 x 70 cm	
BiG Pack 1270 MultiBale BiG Pack 1270 MultiBale VC	120 x 70 Up to 9 small bales go into one big bale	
BiG Pack 1290 BiG Pack 1290 VC	120 x 90 cm	
BiG Pack 1290 HDP BiG Pack 1290 HDP VC	120 x 90 cm	



# BiG Pack

## Timeline

1993

### The first BiG Pack

The BiG Pack is born – KRONE builds its first big baler ...



2003

### Packing several small bales into one big pack

KRONE presents the MultiBale system – the first baler on the market to tie big bales as well as up to nine small bales in one big pack.



2006

### More options

PreChop – The integrated pre-chopping system refines the straw harvest and opens up new opportunities for square bales.



1999

### VFS is launched

KRONE launches the VFS Variable Filling System. The double knotter is now available for many BiG Pack models.

2005

### A new benchmark

The BiG Pack 1290 HDP is launched and has had a significant impact on worldwide straw haulage ever since.



# BiGPACK

2013

## Record throughputs

The BiG Pack HDP II rips up the record book. KRONE launches a completely new big baler that scales new heights in terms of throughput and density.



2017

## Accumulating bales

The KRONE BaleCollect is an effective tool in optimising straw harvesting. This bale collector can collect up to three bales in the field. Thanks to its telescoping drawbar, BaleCollect tracks behind the baler like a trailer on public roads.



2011

## Higher densities and higher throughputs

Generation High-Speed overtakes the big baler market – with up to 20% more throughput than their predecessors while maintaining the same density.

2016

## New, variable cutting system

KRONE's short straw cutting range gets a boost with the 51-blade VariCut (VC) cutting system.

2020

## High Performance

Delivering boosted productivity through higher operator comfort, the new BiG Pack generation is set to supplement the HighSpeed generation.



# KRONE Active Pick-up

- A more effective pick-up thanks to a powered feed roller leaves no haulm behind
- Massive crop press roller for superior performance
- Optional hydraulic pick-up drive with speed control and forward/reverse function
- Smoother running thanks to camless design
- Less wear with 68% fewer moving parts
- Maintenance-free and long-lasting

KRONE Active Pick-up – a clever combination of the tried-and-trusted camless EasyFlow Pick-up plus an additional powered feed roller. The two combined make a perfect match that delivers a pick-up performance second to none on the market while keeping wear to a minimum. More than that, they feed the material in an exceptionally smooth flow into the machine – regardless of whether it is equipped with cutting system or not. Increase your work rates and throughputs.

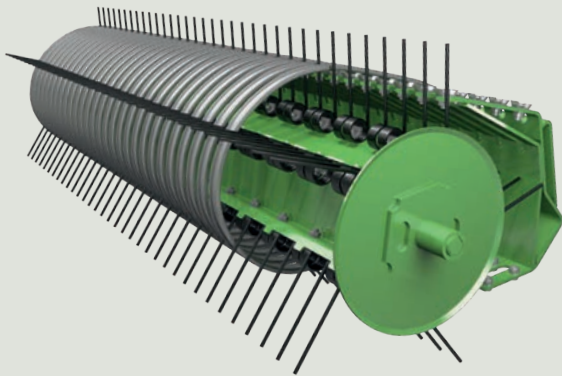

### Less is more

The camless EasyFlow pick-up has a straightforward design and fewer moving parts which ensures quiet running and reduced wear, which in turn translates into reduced service and maintenance costs.



### Nothing is left behind

Working at a width of 2.35 m (DIN 11220) and kitted out with five rows of tines spaced 55 mm apart, the camless EasyFlow Pick-up does a clean job every time. The combination of the powered feed roller and the side-mounted augers tick all the boxes in dry, brittle material, delivering massively increased throughputs.



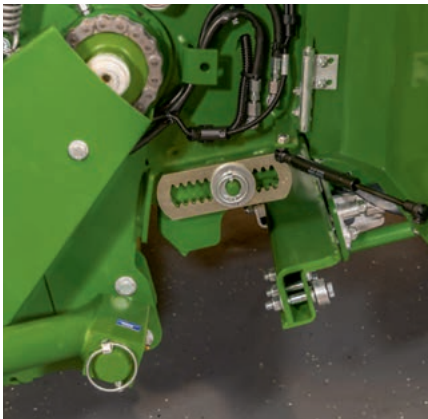

**Depth control fitted as standard**

The standard depth limiter adjusts the pick-up to work in long stubble, reducing the strain on the gauge wheels which only lift the pick-up on very uneven terrain.



**A continuous and smooth flow**

The massive crop press roller ensures a continuous flow of crop into the machine. Its height is conveniently controlled tool-free via chains and suspension comes from springs.



**Ground friendly wheels**

The pneumatic caster wheels follow every curve and are height-adjustable without tools. The sward is even protected on curves, thanks to their excellent castering behaviour.



# The KRONE **VariCut (VC)**

- Up to 51 blades produce short and highest-quality straw
- Variable blade group control for various chop lengths
- Belt drive and four-star rotor for maximum efficiency
- Optional reversing system reduces blockage hold-ups
- Choice of two systems with 26 or 51 blades to suit individual needs

VariCut26 and VariCut51 offer machine buyers a very flexible and easy-to-use solution, a cutting system for big balers that ticks all boxes. VariCut26 with 26 blades is the best option for those who cut at a minimum length of 44 mm whereas VariCut51 with 51 blades is for those who seek cuts of half this length.

### **Convenient overload protection**

A side-mounted poly V-belt drives the pick-up and the rotor. Its slip is constantly monitored so the belt. When there is an overload, the powerflow to the pick-up and the cutting system is automatically cut off. To resume operation, the blades are retracted/extended either automatically or manually.

### **Clamped and secure**

The blades are engaged hydraulically, after which the blade cassette is clamped in the frame. This takes the strain off the cassette's rolls and any vibrations that occur during cutting are safely absorbed, ensuring smooth running when the cassette is inserted and removed.

### **Variable blade control system**

The VariCut 51 system allows operators to select the blades in sets of 51, 26, 25, 12, 5 and the VariCut 26 offers sets of 26, 14, 12, 6, 6 blades. The preselected group is engaged hydraulically from the cab. All cams are attached to the shaft and can be combined to form individual groups.





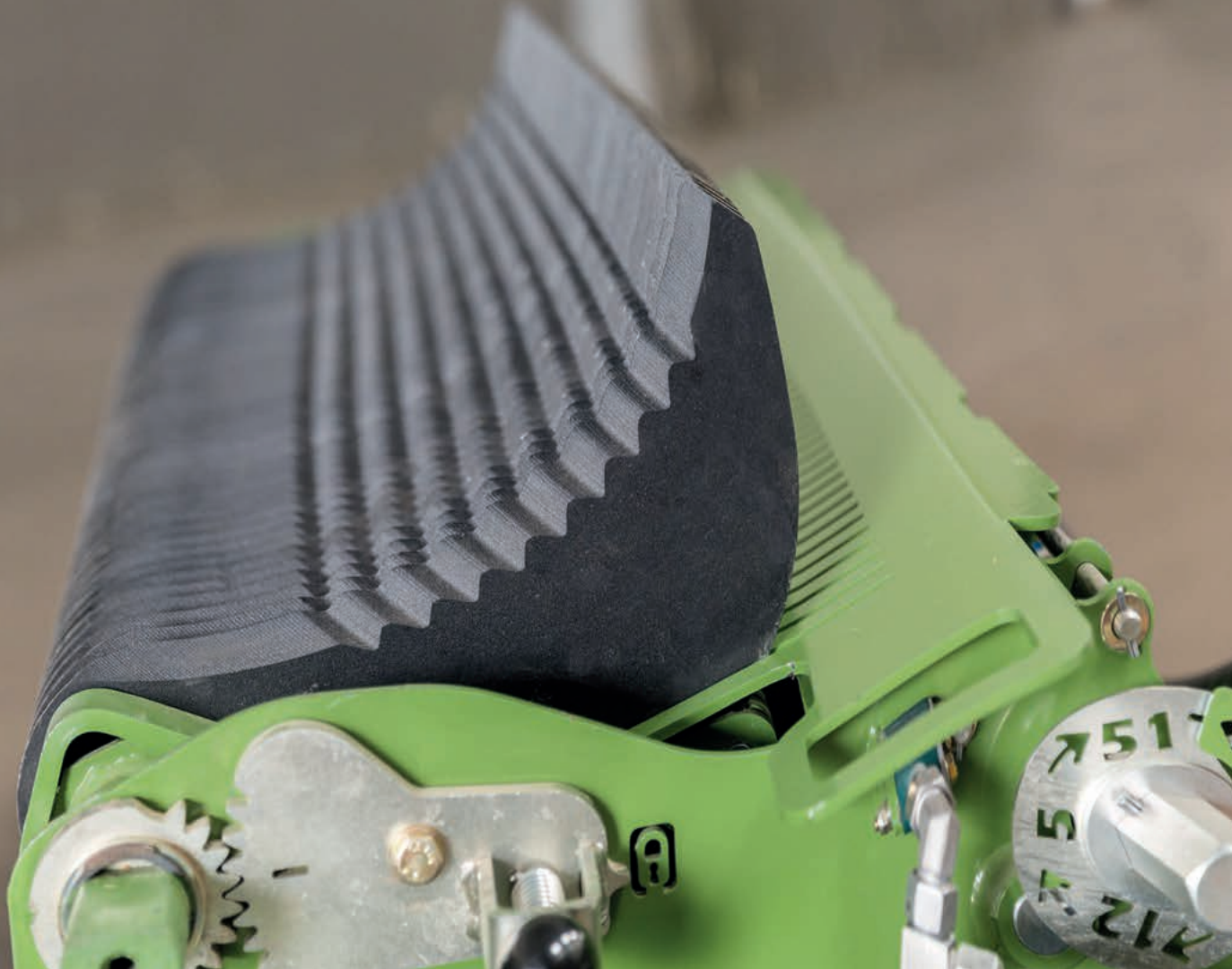

#### **Easy to clean**

A service aperture above the blades can be opened in a single action for removing deposits. The area around the blades and the individual blade protection system on the VariCut 51 is kept clean with an integrated compressed air blower.



#### **Reversing the cutter**

The optional reversing system removes blockages in an instant by reversing the cutting system. The feature is enabled from the cab for convenient removal of an object that causes the blockage.



#### **Convenient to fit and maintain**

For easy removal and maintenance, the single-piece blade cassette pulls out conveniently to the side on an optional transport frame that fits on a pallet truck. It can be removed from the machine when baling hay or other crops that are not chopped.



# The KRONE PreChop

- Short chop lengths – minimum 21 mm nominal lengths
- Adjustable LOC, two selectable counterblades
- Defibrillation effect for added liquid absorption
- Mechanical gearbox and hydraulic height control

PreChop is an integral front-mounted chopping unit on the KRONE big balers of the new BiG Pack 1270 (VC), 1290 (VC) and 1290 HDP (VC) series. It has 96 rotating blades and two rows of 47 counterblades that cut the material to a nominal length of 21 mm. More than that, PreChop also defibrates the stalks visibly.



## Great features for even better productivity

Chopped and nearly dust-free straw makes perfect bedding in poultry houses and cow cubicles as well as in pig and beef cattle housing. More than that, it is used as animal feed that adds fibre to low-fibre rations but also as mulch in strawberry plantations and nutrient medium in mushroom production. The treated straw has better absorption qualities, spreads more easily in the livestock house, and prevents the slurry drains from blocking up while supporting manure mineralization.

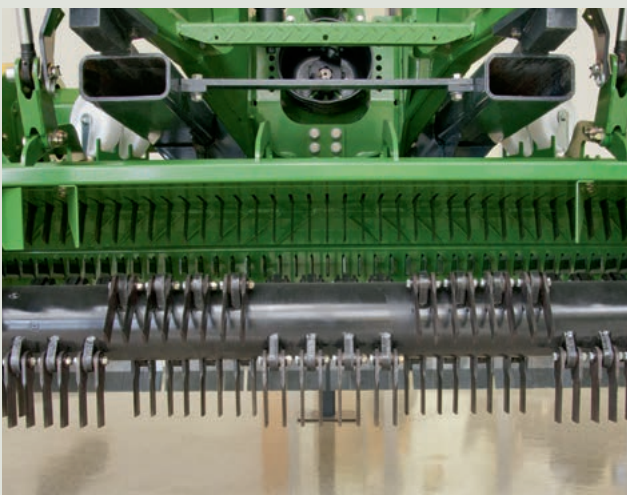

## 190 blades for a top quality chop

The large cutting rotor is 525 mm in diameter and features 96 pivoting blades in a helical arrangement. Rotating at 3,000 rpm, it feeds the material through two rows of counterblades with 47 rigid blades each and from here on to the BiG Pack pick-up. A turbulence generator strip between the counterblades ensures a top quality chop. The intensity of the two counterblades can be adjusted in one of five positions without tools. All blades are reversible for a long service life.





### 1. Easy to remove

If the PreChop isn't needed for an extended period, it can easily be removed. Simply remove the pins and the drive shaft and then pull the unit out to the side on its transport rolls.

### 2. Neat knots

In extremely dusty conditions, a powerful knotted cleaning system is key. The KRONE PowerClean knotted system is a completely new development that cleans not only the knotters but also other areas of the baler.

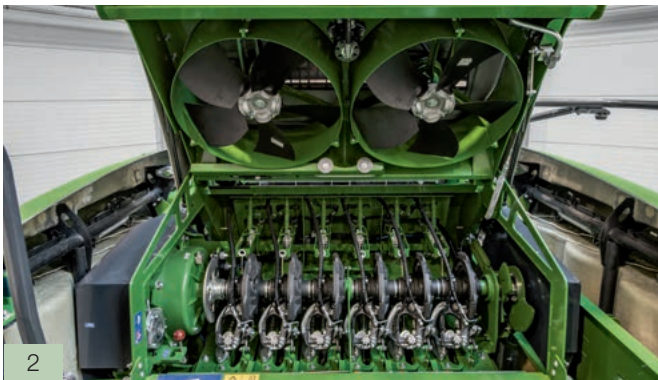

### 3. Versatile Active Pick-up

When used with PreChop, the feed roller on the Active Pick-up can be stopped and switched off if necessary. The crop press roller can also be moved away. The PreChop has a high lift-out height, enabling the baler to be used without removing the PreChop.





# KRONE VFS – The **variable filling system**

- Thorough mixing and uniform pre-compression are the first step to optimum chamber fills
- The pre-compression level is selectable from the terminal
- The feed chamber load indicator helps uninitiated drivers to achieve maximum throughputs
- Overload protection clutch for superior operator comfort
- Best performance in all crops and swath volumes

Tried and tested gets even better! In line with this adage, the VFS variable filling system has received a performance boosting update. Optimum mixing and effective pre-compression in short and different crops were not enough for the KRONE engineers. They have now implemented a feature that allows operators to control the level of pre-compression from the terminal and which keeps them informed on the current load.



Maximum operator comfort and optimum machine utilisation are the parameters that translate into high daily outputs. Pre-compression control from the cab and torque based load information are your tools to operate the BiG Pack in the top output range. Although the throughputs are high, the material is constantly rotated and gently mixed and not exposed to high acceleration forces as on other systems.

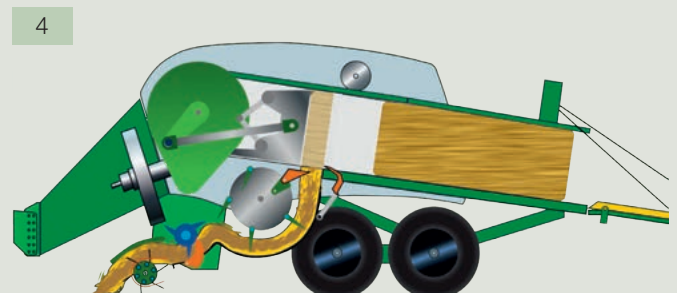
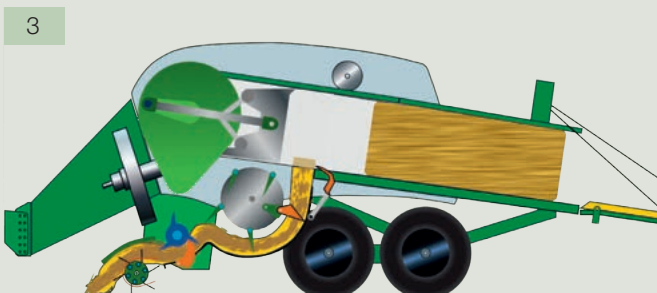
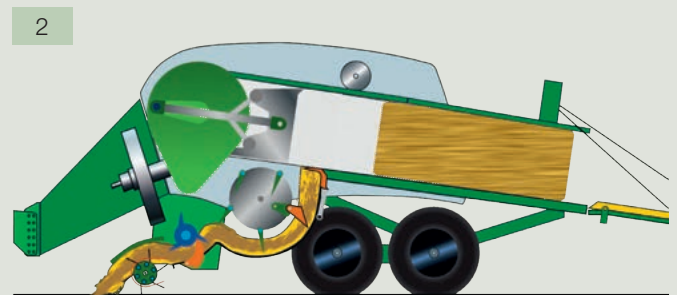
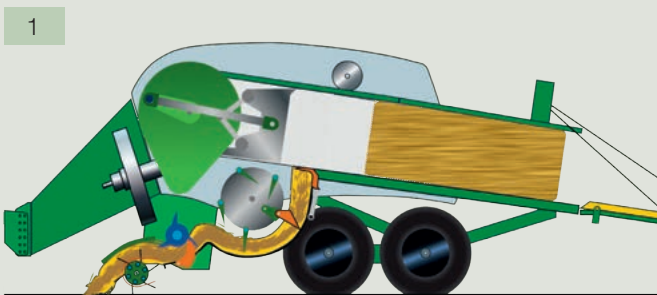





The Variable Filling System is yet another KRONE solution that is highly acclaimed by the farming world. It's another classic example of the innovative force that characterizes KRONE designs. The VFS system combines the best features of continuous feed systems with those of volume-based systems and takes big baler technology to a whole new level. VF translates into maximum efficiency at all times, irrespective of the shape and volume of the swath.

**Fig. 1:**

The VF system uses four packer rakes, one feeder rake and one sensor swing. The packers move in a shared cam track, the feeder rake in a separate cam track which swings into and out of path.

**Fig. 2:**

As long as the feeder cam track does not swing off path, the packers and the feeder continue feeding material into the feed chamber, pre-compressing it as they go. The sensor swing with its retaining tine traps the material inside the feed chamber, preventing it from entering the baling chamber.

**Fig. 3:**

When the pre-chamber is filled to capacity, the sheer volume of the material pushes the swing and retainer into the baling chamber. This clears the way into chamber and triggers the feeders.

**Fig. 4:**

The entire cam track of the feeder rake moves off path so the rake feeds the pre-compressed material into the baling chamber. After that, the sensor swing and cam track return to their previous positions.



# KRONE VFS – The **variable filling system**

- Using the same VFS on all chambers and chamber sizes reduces the number of different parts
- Heavy-duty components sourced from the BiG Pack HDP II ensure superior reliability
- Even uninitiated operators are highly productive thanks to the load indicator and pre-compression control from the terminal.
- The VFS is triggered electrically only when the packers continue filling the pre-compression chamber. It is not triggered when the feeding system is in 1:1 mode.

Ingeniously simple. Simply ingenious. This summarises the key qualities of the KRONE VFS Variable Filling System. A rotor studded with five rows of tines receives the material from the rotor cutter or the pick-up and mixes and compresses it to perfect pre-packs – a technology that ensures the baling chamber is filled uniformly in a consistent flow of material.

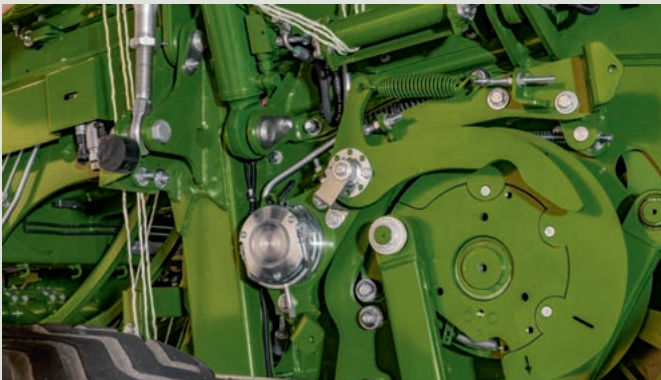

## **VFS control**

The new BiG Pack has a completely new VFS control system which also has a new sensor that monitors the swing. If there is not enough straw in the pre-compression chamber to produce a full-size pack, an electric brake triggers an extra stroke that collects more material. If the brake is not triggered, the system keeps feeding material into the baling chamber at each turn of the packer.

The best part is that operators can control the level of pre-compression, wad thickness and wad number electrically from the cab. From the terminal screen, they can watch the pre-chamber being filled at each turn of the packer and interfere by altering the torque that triggers the mechanism. The brake is not triggered as long as the system is in 1:1 feed mode.



## **The focus is on load and utilisation**

As an option, the driveline torque and hence the load on the VFS and the machine is measured permanently and indicated by a bar graph on the display screen. This allows drivers to operate their BiG Pack at maximum load levels and maximum productivity.





#### **Hard wearing**

The inner cam track of the packers is split in two parts for easy replacement when worn or damaged. The bottom part of the cam track is 20 mm wider and boasts a much more heavy-duty design. Also, the idler wheels and actuator arms are all sourced from BiG Pack HDP II to beef up the new BiG Pack generation.



#### **Auto lubricated**

The automatic lubrication system of the VFS received a comprehensive upgrade that leads to a significant increase in lifespan and dependable operation thanks to shorter service intervals and a new rotary union. These upgrades were developed on new insights won from the BiG Pack X-treme and its work in sugar cane harvesting.

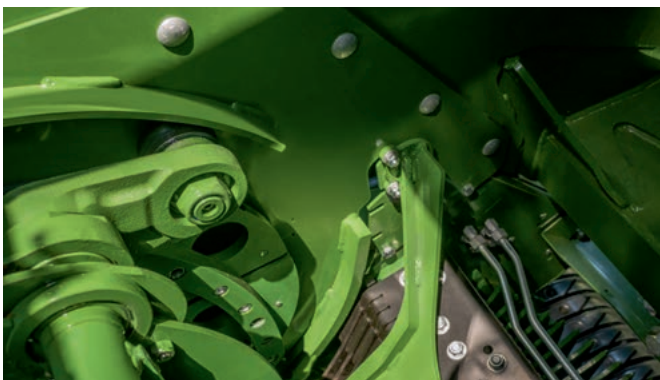

#### **One for all**

All BiG Pack models have the same VFS system. This means all share the same components – an important detail for spare part supplies. The cross section of the VFS system can be altered and adapted to suit the individual machine. This is done by mounting a cross beam to one of several positions. The feature is particularly useful on PreChop machines.



# The driveline

- High inertia and high speeds for a quiet running system
- Power is transmitted down clutch-protected drive shafts
- No shear pins in the drive train for maximum operator comfort
- Hydraulic starting aid is an option for smooth machine starts

KRONE has always preferred massive flywheels that are able to absorb peak loads and improve the fuel efficiency of such a big baler. All chains have been replaced by gearboxes and driveshafts for optimum efficiency throughout the entire powertrain. You won't find shear pins on the KRONE BiG Pack drivelines but overload clutches protecting all drives.



### Starting up hydraulically

A hydraulic start assist system can be specified on each BiG Pack baler for a smooth machine start. The system consists of two hydro motors that accelerate the flywheel before the tractor pto is started.



### Quiet and comfortable

Large flywheels prevent bounce and guarantee a quiet running system. The flywheels absorb peak loads and the machine maintains a consistent work rate whilst requiring significantly less tractor power – for more peace of mind, better fuel efficiency and minimum wear.



### Perfectly protected

On start-up, the driveshaft to the BiG Pack is protected by a slip clutch. When there is an overload an automatic cut-out clutch is activated protecting the baler effectively from the energy that is stored in the flywheel. The two clutches are located in front of the flywheel for easy access and servicing.





### Shafts and gearboxes

On KRONE big balers, power is transmitted to the packer and the knotters via robust, low-maintenance drive shafts, gears and overload clutches. Buying this technology means buying into dependability and comfort.



### On-board hydraulics

The VariCut belt drive, the bale chamber control system and the KRONE PowerClean system have their own hydraulic on-board system so these assemblies do not tap into the tractor's oil reserve.



# The **baling chamber**

- A longer baling chamber for firmer, tighter bales in dry crops
- Massive hydraulic cylinders control the baling pressure
- An electronic star wheel sensor ensures uniform bale lengths
- Electronic baling pressure control for even bale densities
- Deselectable pusher dogs either push out only the last bale or clear the entire chamber.

BiG Pack features a 20% longer baling chamber that has now a full-width top plate to produce even firmer, tighter bales especially in very dry crops and at high work rates and throughputs. The on-board hydraulic system with automatic baling pressure control ensures firm bale shapes and tidy edges, even in wet conditions and in different crops.



### **Full-on power for rock-solid bales**

The length of the baling chamber has been increased by 20% to 3.60 m. The BiG Pack 1290 HDP chamber has standard wear plates at the front end which help press the material into perfect bales and reduce machine wear. Up to six massive rams operate the top and the side walls of the chamber. The heavy-duty yoke is designed to cope with exceptionally high loads in non-stop operation.



### **Extendable rear end**

The BiG Pack features a very strong frame that also has a hitch to pull a bale for example. The BiG Pack features a very strong frame that also has a hitch to pull a bale accumulator for example.



### **Consistent bale length every time**

KRONE equips all BiG Packs with a star wheel that measures the bale length electronically. Arranged in the middle of the baling chamber, the wheel is encased for protection from objects and debris.



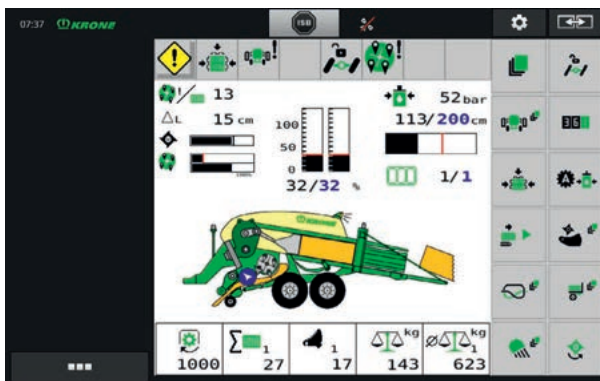

### Automatic mode

The operator selects a density between 0% and 100% on the control box and the baling force control adapts the baling pressure automatically. This way, you get uniform and consistent bale densities also in varying conditions.

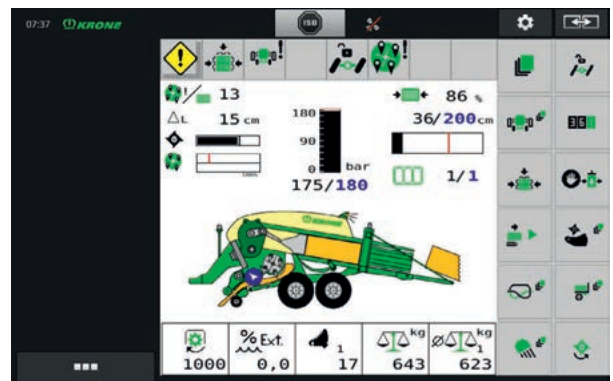

### Manual mode

By default, the baler starts up in manual mode at a pressure of 50 bar. The first chamber filling should always be carried out in manual mode. After that you can select auto mode. Alternatively, you can choose and set a different default pressure between 0 bar and 180 bar. This, however, will disable the auto mode option.



### Ejecting the bale

The pusher dogs are deselectable so you can choose whether only some are in action to push out the last bale or all of them to clear the chamber. When the operator enables the pusher dogs, the baling pressure is automatically reduced to a customisable level. This makes ejecting the bale easier depending on the crop. In auto mode, the pusher dogs carry out several cycles.



# The KRONE knotter system

- Double knotter technology for extra reliability
- An optional machine cleaning system is available as an alternative to the standard pneumatic cleaning system
- Central lubrication provided as standard
- Long service life

There is no way around double knotters when the task is to make high-density bales. The technology feeds the upper- and under-thread to the knotter without tensioning them. The threads are fixed inside the knotter only for the short moment of tying the knot. This reduces significantly the strain on the thread and on the knotter increasing the reliability of the system.

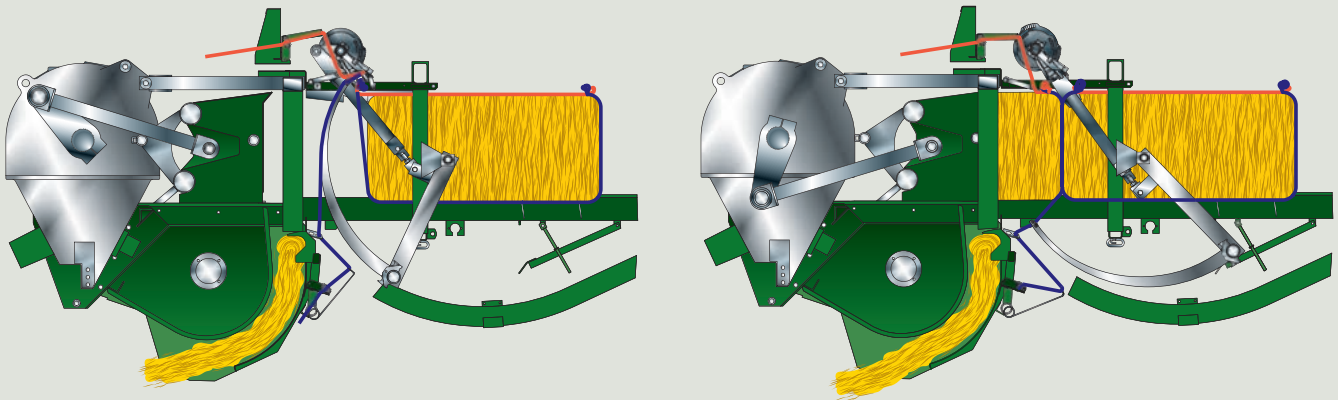

## How the double knotter works

The knotter feeds an upper and a lower twine to the bale as it is being pressed and ties the twine with two knots – one at the front end of the bale (starter knot no. 1) and one at the rear end (finishing knot no. 2). The lower twine is threaded through the needle by a tensioning system that surrounds the

base and the two ends of the bale. The upper twine is supplied to the bale directly by a tensioning system and encloses the top of the bale. This system allows the machine to apply maximum baling force in any type of crop.



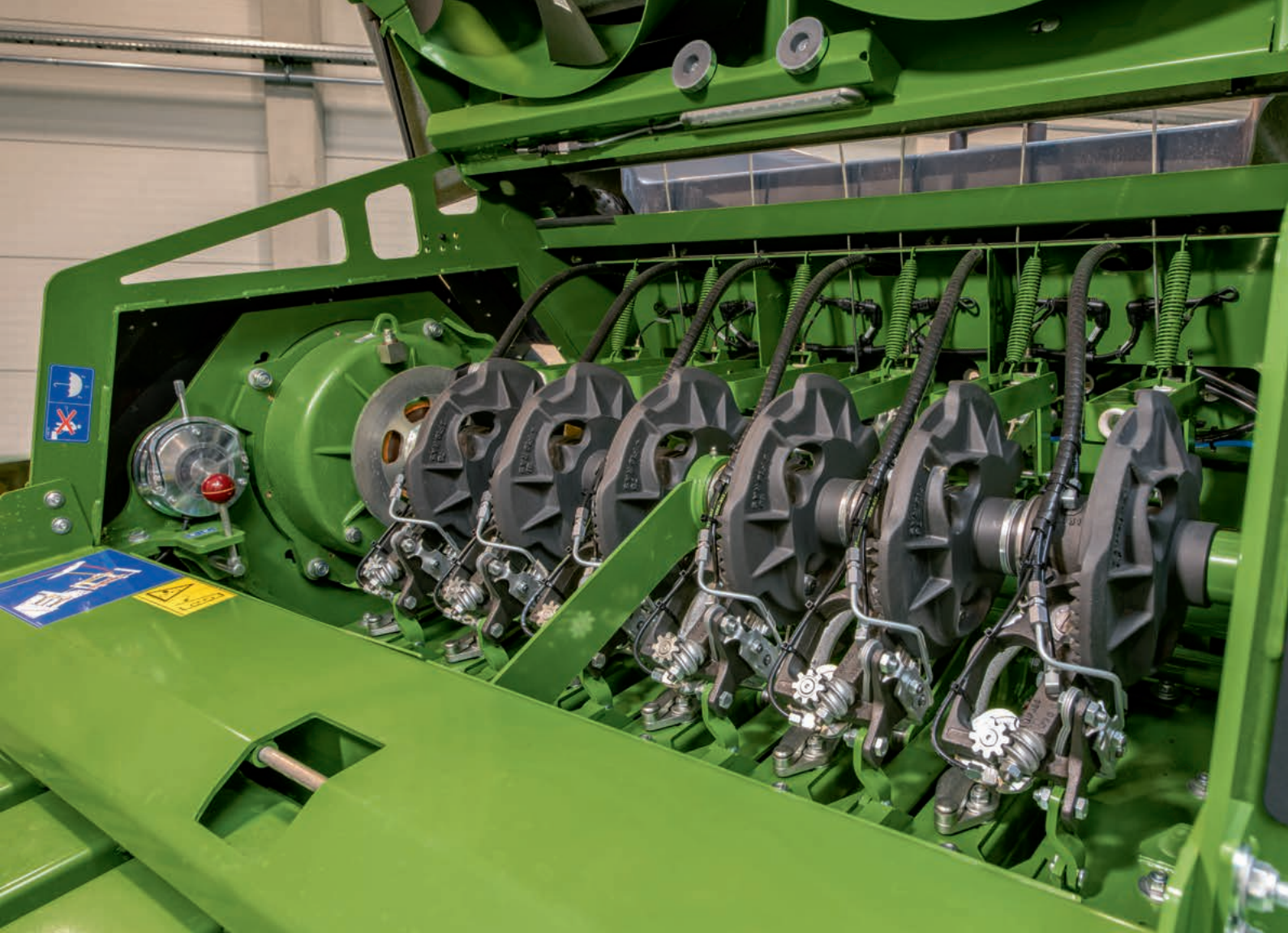

### Plenty of twine on the machine

The updates on the twine boxes refer to functions and features but also to the styling. The twine box is integrated in the side panel and opens without tools. The panel keeps the twine balls clean and free of debris. 15 balls feed the twine in a logical arrangement. The box even holds 15 kg balls as an alternative to the customary 11 kg balls – a small detail that expands your operating range significantly.



### How about a little extra?

In addition to the main twine boxes, KRONE is the only manufacturer to offer two extra twine boxes that are mounted at the rear end of the machine. In between them, the boxes hold six 15 kg twine balls, allowing operators to extend their range by approx. 250-300 bales.



# KRONE PowerClean

- Effectively avoids build-up of crop and debris
- Hydraulically powered for superior performance
- Cleans the knotters, the machine sides and axles
- Superior convenience and safety

The KRONE PowerClean is a pioneer development that cleans not only the knotter bay but also large areas of the machine. Maintaining a high air pressure inside the knotter bay, the system prevents material from collecting here in the first place. From here, the air flow is directed to the areas behind the twine boxes and down to the axles, cleaning the machine at maximum convenience and ensuring maximum safety in the field and on roads.



### Easy access

The large knotter bay opens easily without tools for convenient access to the knotters. The turbines stop automatically when the deck opens.



### Powerful drive

The on-board hydraulic system powers the fan effectively as the pto is engaged. Superseding the existing pneumatic cleaner, the new system requires substantially less tractor power.



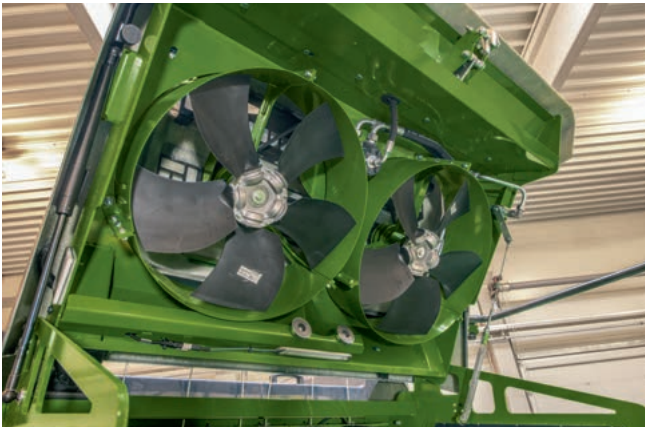

**Massive fans**

Two turbines feed the air from the rear into the knotter bay, creating an overpressure and preventing debris from depositing here in the first place. From here, the exhaust air is directed to the area behind the twine boxes and down to the axles, keeping these areas clean too.



**Boxed and sealed**

The knotter bay is covered by a stylish plastic deck which gives maximum protection.











# KRONE MultiBale

- Up to nine small bales in one single big pack
- Small bales from 0.30 to 1.35 m
- BiG performance in the field
- Small bales for easy handling in the yard

The KRONE MultiBale system converts your BiG Pack 1270 into a veritable multi-purpose machine. Available as an option, the kit allows you to make huge bales and clear even large fields fast and efficiently and at the same time deliver your customers small packs that are easy to handle in the barn without a loader. KRONE MultiBale is a unique system that gives you an edge over your competitors and helps expand your business.



### Customers' wishes come true

Up to nine single bales are packed in one big bale: The award-winning MultiBale system changes straw handling processes in the barn and stable. The small packs are 0.30 m to 1.35 m in size, allowing users to handle them easily and without the need for costly machinery. This said, you can of course continue baling regular 2.70 m long bales.

### From big to small

On the move, the operator sets the required number of bales on the control box in the cab, selecting the total length of the big bale and the number of small packs. The small bales are held together with two strings, whereas the big bale has four. Naturally you can also produce conventional full-size single bales tied with six strings.

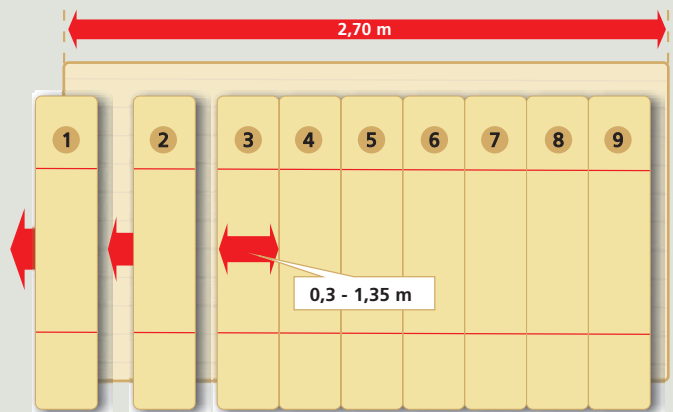



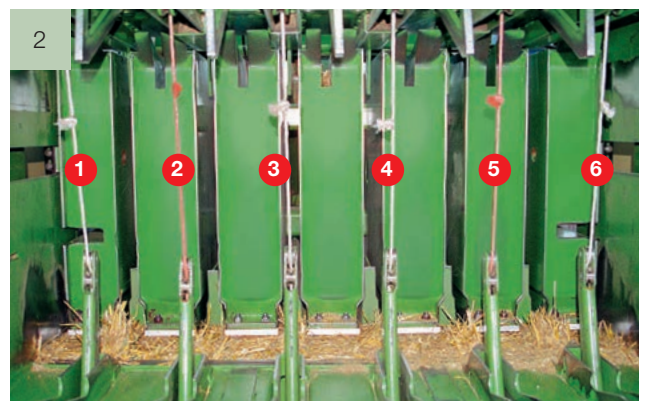
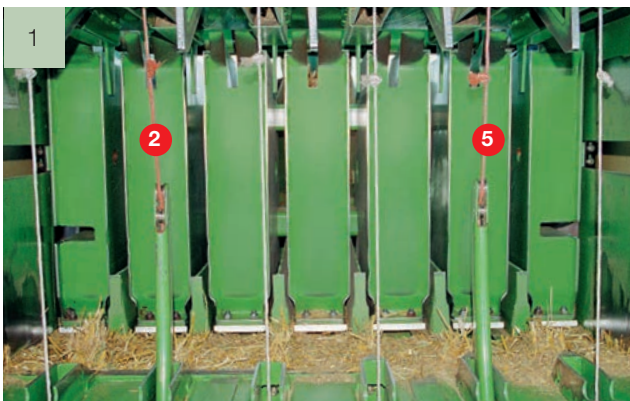

### Divided needle yokes

In MultiBale mode, two knotters knot the small packs and the others tie the big bale, assisted by a divided needle yoke. The two needle yokes are coupled and uncoupled by a controlled latch. For the double knotter to tie the knot, it needs to be supplied with twine. Therefore, the other strings simply pass through underneath the knotters. The small bales are tied with two lengths of twine (1). When the bale is complete, the two yokes are automatically re-engaged so that all the knotters are now supplied with twine (2). Then the big bale is tied.





# Tractor attachment and chassis

- Stronger axle offers tongue loads of up to 3 tonnes
- Choice of top-mount or bottom-mount hitches and various hitch types
- New and stronger BPW tandem axle for up to 60 km/h
- The boogie axle with parabolic springs for superior rides is a special BPW development for BiG Pack

The KRONE BiG Pack offers convenient and safe rides in the field and during road transport thanks to a rigid or caster-steer tandem axle offering up to 60 km/h.



## Bottom- or top-mount drawbar

All BiG Pack models attach to top-mount or bottom-mount tractor ends – thanks to the modular drawbar that offers tongue loads of up to three tonnes. The compact drive shaft comes with a special holder that offers various positions so the shaft is always as straight as possible. Optional guards are available to protect tractor wheels when making tight turns. A large choice of hitch types is available that suit various national requirements.



## Bottom-mount hitch

An 80 ball hitch is an option for all BiG Packs. Choose between the ball hitch and ring hitch for use with the pivoting drawbar. The clutches are auto lubricated as a standard feature.



## Stand

This hydraulic stand is an option and very useful for attachment/removal of machines with 80 ball hitches. The stand is controlled by a double-acting coupler and from the tractor's oil reservoir. A mechanical stand is available as an option.





#### Caster-steered tandem axle

The spring-suspended Boogie tandem axle provides smooth and quiet running even at 60 km/h, taking strain off man and machine. The caster-steered rear wheels manage every turn treading gently on the valuable sward. When the machine reverses or travels at speed the steered axle is automatically aligned and locked hydraulically in its straight-ahead position.



#### Big boots

All BiG Packs can take either 500/60 R22.5 or 620/50 R22.5 tyres – the higher-quality radial plies of course. Both sizes have identical diameters but different widths. Neither tyre will push the total machine width beyond the 3 m mark. In addition, 26.5 inch tyres are available for machines with a cutting system.



#### Servicing made easy

The steered axle is now much easier to service. All lubrications points with less-than-50-hours service intervals are now serviced by the auto lubricator. This cuts the time you spend servicing the machine and keeps the grease nipples clean and tidy.



# Operation

- High-resolution colour touchscreens
- The control units on KRONE BiG Pack big balers are all ISOBUS-compatible.
- When hitched to an ISOBUS-compatible tractor, the KRONE BiG Pack can be operated from the tractor terminal.
- On-board control panels allow operators to operate individual assemblies from the ground when servicing the machine

Even the entry-level DS 500 from KRONE offers convenient and comprehensive control of all major functions from a colour touchscreen. The CCI 800 and CCI 1200 ISOBUS terminals take user comfort to the max, offering one screen that displays both the machine user interface and the images that are fed from camera.



### The DS 500 Terminal

The compact DS 500 terminal has a 5.7" colour display screen with a clear layout for easy use. You can either operate the machine from the 12 function keys or the touchscreen and the dial control on the back of the device.



### The CCI 800 Terminal

The CCI 800 ISOBUS terminal with 8" touchscreen serves as user interface and also as camera screen which feeds the images from the bale accumulator for example, offering multifunctionality that saves costs and frees cab space for uninterrupted view. The individual machine functions are shown in mini-view format on the bright, high-resolution colour screen.





### The CCI 1200 Terminal

The new ISOBUS-compatible CCI 1200 terminal with its 12" touch screen displays the views of two universal terminals (UT) on one screen. This allows the operator to control combinations such as a BiG Pack and a BaleCollect from one single terminal and view footage from several cameras on the same screen – a money-saving feature that provides a better all-round view from the cab. The individual machine functions are shown in mini-view format on the bright, high-resolution colour screen.



### The tractor terminal

All ISOBUS-compatible KRONE machines can also be controlled from the tractor's existing ISOBUS terminal. Simply connect one single cable and enjoy your customized user interface on the terminal in the cab. Optional controls like the WTK joystick make the tractor even easier to operate, depending on the tractor specification.



### The controls

The cutting system, the twine boxes, the bale chute and the pusher dogs as well as the LED work and service lights are operated from these BUS controls on the machine. The buttons are backlit and the LED comes on to confirm the specific function has been correctly enabled.



## Service and maintenance

- The side panels open and close hydraulically for convenient twine refills and optimum access to service and maintenance points
- Auto lubricator extends service intervals and minimises time spent servicing
- Hand wash tank with soap dispenser

Regular servicing increases reliability and lifespan of your BiG Pack. Therefore KRONE developed an innovative folding mechanism that opens the side panels hydraulically for convenient service, repair and twine refills. LED lights come on automatically when you open the panels and lower the twine boxes for excellent visibility day and night.



### At eye level

In order to service a machine properly it is necessary to access all service and maintenance points easily and conveniently. Following this logic, the BiG Pack side panels can also be controlled from the cab or from the keypad panel at the rear end of the machine. Opening wide and clear, they give plenty of headroom and access to all service points at eye level.



### Ergonomically designed

The twine boxes beneath the side panels lower hydraulically to a convenient height. They are opened without tools for optimum access to and easy replacement of the twine balls.





### Runs like a charm

The auto lubricator and its large grease reservoir allow operators to spend less time servicing and maintaining the machine. The unit sits underneath the left panel where it is protected from UV radiation.



### Hand wash

An extra water tank with an integral soap dispenser sits at the rear of the machine, allowing you to wash your hands after a brief intervention on the machine and get back on the tractor with clean hands.





# The lights

- Standard LED lights around the twine boxes and knotters for excellent visibility
- Further LED options are available for maximum operator comfort during night work
- Optional LED working lights enhance visibility in the field
- Choice of lighting kits available to suit individual needs



Work lights on the twine boxes



Lights in the knotted bay

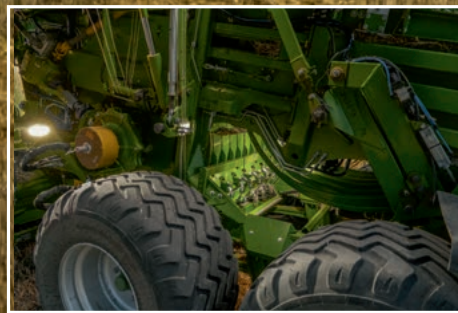

Lights on the needles



Lights inside the twine boxes



Lights behind the twine boxes



**Turn night into day!** Opt for one of the many lighting kits that are available from KRONE and specify your BiG Pack to your individual needs and requirements. The lights inside the twine boxes, above the needles and inside the knotter bay are standard specification. In addition to these, you can opt for more lights at service points and more LED working lights.



Rear view



Lights on steps



Lights on the pick-up



LED lighting





# High-Density-Press: **BiG Pack 1290 HDP (VC)**

- Ground-breaking high-density baling technology
- Exceptionally high density and excellent handling
- Even more efficient straw logistics

These days roughly one in every 10 big balers sold worldwide is a KRONE BiG Pack 1290 HDP. This machine delivers high-density 120 x 90 cm square bales.



### **Get the field cleared fast**

Harvesting a crop that yields 4 tonnes of straw per hectare and producing 500 kg bales rather than the 400 kg from a conventional big baler cuts the number of bales to be collected by two per hectare. Even though the machine uses higher quality twine – KRONE recommends the KRONE excellent HDP Strong<sup>2</sup> – twine costs drop by up to 25% courtesy of the higher baling density.



### **Cutting costs**

The profitability and cost-effectiveness of straw baling depends to a great extent on the baling, transportation and storage costs. KRONE has the answer with the HDP system. The up to 25% higher density bales cut the production costs per tonne, increasing the profit potential of professional straw sales. A BiG Pack HDP is your guarantee of success. It's the smart way to work.





## The HDP concept

Back in 2003, KRONE took an in-depth look at how to optimize the straw haulage chain.

### Large-scale bale handling involves the following aspects:

- collection and handling is time consuming
- expensive labour
- expensive logistics
- inadequate use of truck capacity
- large storage capacities needed

The only way to optimize all parameters was to **increase bale weights** by **increasing densities**.

And so the concept of the **High-Density Press** was born.



# The KRONE **BaleCollect** accumulator

- Saves time and money in big bale logistics
- Telescoping drawbar for optimum rides behind the tractor
- Choice of unloading modes for subsequent work steps
- Standard and integral weighing system
- Efficient and gentle on the soil

Running behind the baler, the KRONE BaleCollect collects up to three square bales from a 120 cm wide chamber or up to five bales from an 80 cm chamber. And has a choice of unloading modes to prepare the bales for the next steps in the field, significantly shortening post-baling loading times, reducing journeys and minimizing soil compaction.



## How it works

The BaleCollect platform can store up to three bales that leave a 120 cm chamber or up to five bales from an 80 cm chamber. When a bale leaves the chamber it is pushed to the right or left side by a bar, clearing the way for the next bale to enter the platform. All bales are automatically pushed off the platform according to the unloading mode selected by the operator.



## Smart and safe road travel

The bale accumulator is attached to the baler to collect the bales as they leave the baling chamber. To ensure safety on the road, KRONE has come up with an innovative attachment via the telescoping drawbar. For road transport, the platform folds into a compact unit of less than 3 m, the drawbar ex-

tends and the casting wheels/axles are made rigid. This allows BaleCollect to track reliably behind the baler – for safe rides at high speeds of up to 50 km/h and through narrow gates.





### 5 different cam tracks

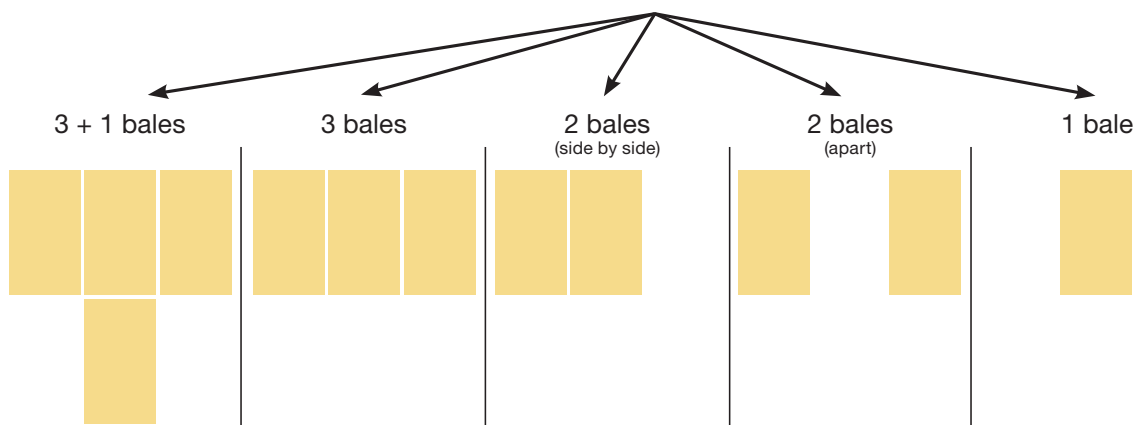

#### Depositing the bales to needs

Depending on the individual harvest and process chain, customers may want to have their bales deposited in specific patterns. BaleCollect offers five different unloading modes for 120 cm wide bales. The '3 bales' or '3+1 bales' modes are used to deposit all bales on or near the headland. By comparison, silage bales will be deposited to the '2 bales side by side' mode or the '2 bales apart' mode. Of course, the operator can also push off the bales manually at any time by pressing a button. An optional GPS-based feature deposits the bales along up to five A-B lines.



# Silage additive dispenser

for the 5th generation BiG Pack

- A 400-litre tank is mounted above the bale chamber behind the yoke.
- A mobile pump assembly is housed in an easy-access and dust-tight box on the yoke.
- Spray nozzles above the pick-up apply the additive at selectable and uniform rates across the pick-up width.
- Various applications programs are available for accurate rates and best forage quality.
- Easy use, service and maintenance

The optional und integral silage additive dispenser offers even more versatile options on the 5th generation BiG Pack models. The unit is used for applying silage and conservation additives when moisture levels are not ideal or for boosting the fermentation process in the bale.



## Enough additives on board

The 400-litre tank for additives is a special development for the 5th generation BiG Pack where it is mounted on top of the baling chamber at the rear end of the machine. It has an electric filling level sensor that constantly sends its information to the cab terminal. The tank is either filled through the large and screened opening or through the side-mounted riser pipe at the rear end of the machine.



## Dust-proof pump housing

The pump and all filters and valves are grouped into a dust-sealed box on the yoke. The unit is easily removed from the machine without tools when preparing the machine for winter storage. Useful features such as an air connector help drain the pipes and the box effectively. An extra button operates the pump manually for service and maintenance.





**Accurate application**

Two flat spray nozzles at the end of each feed line apply a uniform spray on the material as it passes through the pick-up. The installation of two lines enables KRONE to implement three different application rates to deal with three different moisture levels. The nozzle holders fold out without tools for easy maintenance.



**Easy operation**

Forming an integral feature of the BiG Pack operator terminal, the dispenser offers various application modes – application at a fixed rate (l/min), at a throughput-related rate (requires the optional weighing chute), at one of three different moisture-level related rates (requires the optional moisture measuring system) or by flow rate percentage. All application rates are set up easily and conveniently in the menu settings.





# Options

The right kit for every job

- Fully integrated moisture sensor in the baling chamber
- Fully integrated weighing system in the bale chute
- Camera system for safe reversing
- Extra twine boxes at the rear
- Silage additive dispenser optimises the forage quality

For even greater convenience and effectiveness, choose from a number of options that add even more features to your machine, including moisture sensing and bale weighing systems that give accurate information on the job at hand, or LED work lights and reverse cameras for unobstructed vision and a clear all-round view.



### Hitch for quiet running

Farmers in different countries use different attachment systems: A top- and bottom-mount drawbar is a standard feature on all BiG Packs. A ball- or ring-hitch drawbar is an option for all BiG Packs. Choose between the ball hitch and ring hitch for use with the pivoting drawbar.



### Smooth start

All KRONE big balers feature a hydraulic start assist system. Two hydro-motors bring the flywheel up to speed before the tractor pto is engaged – all operated conveniently via the terminal in the cab, naturally.



### Standing firm

To enable the machines to be attached and removed even more easily, KRONE offers an optional hydraulic stand for all BiG Packs. The hydraulic unit is double-acting and controlled by the tractor hydraulics.





#### **More twine on board**

In addition to the regular twine boxes, KRONE offers two extra boxes that are mounted at the rear end of the machine. In between them, the two boxes hold six 15 kg twine balls for boosted daily outputs.



#### **Cutting edge**

All BiG Pack machines with the XCut or VariCut cutting system and PreChop can be fitted with an extra set of blades as an option.



#### **KRONE PowerClean**

KRONE is leading the way in terms of machine cleaning. The new cleaning system consists of two hydraulic turbines that create an overpressure inside the knoter bay, preventing any debris from collecting here in the first place. From here, the air flow is directed to the areas behind the twine boxes and down to the axles.





# Options

Further options for more operator comfort

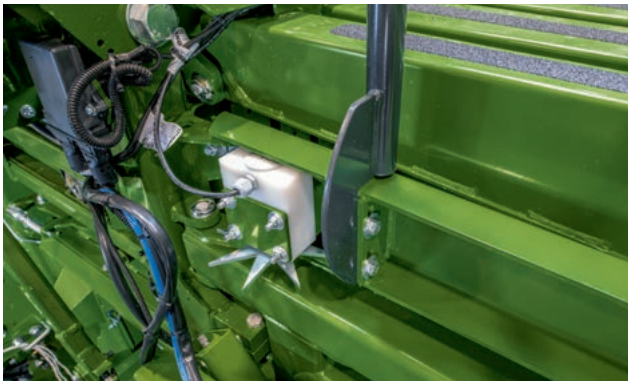

## Clear crop quality display

The data from the optional moisture sensor at the entrance of the baling chamber are read out on the display screen, keeping operators informed on current conditions. The information is read out on a cab-based monitor. An alarm is issued automatically whenever a preset parameter is exceeded.



## Precise weight

Would you like to keep track of whether the bale weight is meeting your customers' needs? Then the optional bale chute with integrated weighing system is just the right technology for you. The terminal displays not just the weight of every single bale but also the total weight of the finished baling job.



## Clear view to all sides

You can opt for a reverse-drive CCTV system that comprises a camera and a colour screen which has a second port for a second camera. The camera can also connect to the CCI terminal.





#### **KRONE SmartConnect KSC – the telematics unit**

The KRONE SmartConnect telematics unit is the hardware element of the KRONE data management system. No matter whether you prefer the Agrirouter, KRONE Smart Telematics or simply E-Solutions software licences – KRONE SmartConnect with a multi-network SIM card is the easiest way to make a connection, because it logs automatically into the network that offers best reception at the site. KSC is a standard feature on the BiG Pack.



#### **KRONE Smart Telematics**

KRONE Smart Telematics offer fleet managers a bird's-eye view of all machines and their data, keeping them on top of what's going on in the harvest chain without having to make a single phone call. The system generates clear bale maps and detailed information on each bale. There is no better way to document a job! And with a few clicks, you convert the data to simple pdf reports.



#### **agrirouter – the data sharing hub**





















agrirouter is an internet-based and universal data sharing hub for farmers and contractors that connects machines and farm software applications no matter the brand or developer. The universal approach allows owners of mixed fleets to use and share the data of all their machines – a huge benefit that saves time and increases productivity of your business.











# KRONE excellent twine

- This twine has been developed and optimized to the specifications of the KRONE BiG Pack baler and its knotting system.
- Greatest knot strength, superior to regular twines
- Optimum fibrilling ensures effective knotting

					
		MultiBale (Smart) <sup>2</sup>	HDP Smart <sup>2</sup>	HDP Strong <sup>2</sup>	HDP X-treme <sup>2</sup>
	Knotters	Regular bale density	High bale density	Very high bale density	Extremely high bale density
BiG Pack 870 HDP 80 x 70 cm (2'7.5" x 2'4")		5			
BiG Pack 890 80 x 90 cm (2'7.5" x 2'11")		4			
BiG Pack 1270 120 x 70 cm (3'11" x 2'4")		6			
BiG Pack 1290 120 x 90 cm (3'11" x 2'11")		6			
BiG Pack 1290 HDP 120 x 90 cm (3'11" x 2'11")		6			
BiG Pack 1290 HDP II 120 x 90 cm (3'11" x 2'11")		8			
BiG Pack 4x4 120 x 130 cm (3'11" x 4'3")		6			



		MultiBale Smart <sup>2</sup>	MultiBale	MultiBale <sup>2</sup>	HDP Smart <sup>2</sup>	HDP Strong <sup>2</sup>	HDP X-treme <sup>2</sup>
Double pack	order no.	27 023 342 0	927 943 0	923 944 0	27 023 343 0	27 023 217 0	27 023 218 0
Colour							
Max. knot strength	kgf	245	245	245	280	315	335
Weight	kg/roll	11	10	11	11	11	11
Roll length	m/roll	1,342	1,050	1,430	1,287	1,188	1,122
Roll length	m/kg	122	105	130	117	108	102
UV-stability		high	high	high	high	high	high





### New KRONE excellent twines

KRONE is the only manufacturer to offer 15 kg twine balls in addition to the well-proven 11 kg balls. More twine per ball translates into fewer refills and higher productivity – so operators gain time, comfort and reliability.

- Approx. 36% extra roll length and consistent knot strength
- Fewer refills – more bales per day
- Gain in comfort and time
- More savings, higher productivity



#### HDP Strong<sup>2</sup> 11 kg

The well-proven 11 kg twine balls suit all BiG Pack models including the new 305 and 405 models.



#### HDP Strong<sup>2</sup> 15 kg

This is a special development for the fifth generation of BiG Pack 305 and 405 models – the new 15 kg twine balls boost your twine reserves and daily output.

		MultiBale <sup>2</sup> 15 kg	HDP Strong <sup>2</sup> 15 kg	HDP X-treme <sup>2</sup> 15 kg	
<b>NEW</b>	Order no.	27 025 897 0	27 025 895 0	27 025 896 0	
	Colour				
	Max. knot strength	kgf	245	315	335
	Weight	kg/roll	15	15	15
	Roll length	m/roll	1,950	1,620	1,530
	Roll length	m/kg	130	108	102
	UV-stability		high	high	high



# Technical data

## The BiG Pack (BPx05) programme

		BiG Pack 1270 (BP 305-10)	BiG Pack 1270 VC (BP 305-11)	BiG Pack 1290 (BP 405-10)
Chamber width x height	cm	120 x 70 (3'11" x 2'4")	120 x 70 (3'11" x 2'4")	120x90 (3'11" x 2'11")
Bale length	m	1.0 - 3.2 (3'3" - 10'6")	1.0 - 3.2 (3'3" - 10'6")	1.0-3.2 (3'3" - 10'6")
Tractor power	min. kW/hp	120 / 163	140 / 190	120 / 163
Pick-up work width DIN	m	2.35 (7'9")	2.35 (7'9")	2.35 (7'9")
Length in transport position	m	8.85 (29'0")	8.85 (29'0")	8.85 (29'0")
Length in working position*	approx. m	10.31 (32'11")	10.31 (32'11")	10.31 (32'11")
Height	m	3.25 (10'8")	3.25 (10'8")	3.45 (11'4")
Width	m	2.99 (9'10")	2.99 (9'10")	2.99 (9'10")
Min weight**	approx. kg	10,500 (23,148 lbs)	12,300 (27,117 lbs)	11,000 (24,251 lbs)
Tyres for the 40 km/h (25 mph) single axle		–	–	–
Tyres for 50-60 km/h (31 - 37 mph) tandem axles		500/60 R22.5 620/50 R22.5	500/60 R22.5 620/50 R22.5 620/55 R26.5**** 710/50 R26.5 (Width 3.18)****	500/60 R22.5 620/50 R22.5
Brakes		Air/hydr.	Air/hydr.	Air/hydr.
Twine storage**	No. of rolls	30	30	30
PreChop		–	Optional	–
		–	–	–
Double knotter		6 series	6 series	6 series
MultiBale		Optional	Optional	–
Max. no. of blades		–	VC26 = 26 / VC51 = 51	–
Min. cutting length	mm	–	44 / 22	–
Plunger strokes	no. of strokes/minute	45	45	45
BaleCollect		Optional	Optional	Optional

All specifications, weights and dimensions do not necessarily comply with standard specifications and are therefore not binding. Specifications are subject to change without notice.

\* with weighing chute

\*\* Varies according to machine specification

\*\*\* Including the optional twine boxes (+ 12 balls)

\*\*\*\* These tyres add approx. 22 cm to the total machine height.





		BiG Pack 1290 VC (BP 405-11)	BiG Pack 1290 HDP (BP 405-20)	BiG Pack 1290 HDP VC (BP 405-21)
Chamber width x height	cm	120x90 (3'11" x 2'11")	120x90 (3'11" x 2'11")	120x90 (3'11" x 2'11")
Bale length	m	1.0 - 3.2 (3'3" - 10'6")	1.0 - 3.2 (3'3" - 10'6")	1.0 - 3.2 (3'3" - 10'6")
Tractor power	min. kW/hp	140 / 190	155 / 210	180 / 245
Pick-up work width DIN	m	2.35 (7'9")	2.35 (7'9")	2.35 (7'9")
Length in transport position	m	8.85 (29'0")	8.85 (29'0")	8.85 (29'0")
Length in working position*	approx. m	10.31 (32'11")	10.31 (32'11")	10.31 (32'11")
Height	m	3.45 (11'4")	3.45 (11'4")	3.45 (11'4")
Width	m	2.99 (9'10")	2.99 (9'10")	2.99 (9'10")
Min weight**	approx. kg	12,800 (28,219 lbs)	12,900 (28,439 lbs)	14,700 (32,408 lbs)
Tyres for the 40 km/h (25 mph) single axle		–	–	–
Tyres for 50-60 km/h (31 - 37 mph) tandem axles		500/60 R22.5 620/50 R22.5 620/55 R26.5**** 710/50 R26.5 (Width 3.18)****	500/60 R22.5 620/50 R22.5	500/60 R22.5 620/50 R22.5 620/55 R26.5**** 710/50 R26.5 (Width 3.18)****
Brakes		Air/hydr.	Air/hydr.	Air/hydr.
Twine storage**	No. of rolls	30	30	30
PreChop		Optional	–	Optional
				–
Double knotter		6 series	6 series	6 series
MultiBale		–	–	–
Max. no. of blades		VC26 = 26 / VC51 = 51	-	VC26 = 26 / VC51 = 51
Min. cutting length	mm	44/22	-	44/22
Plunger strokes	no. of strokes/minute	45	45	45
BaleCollect		Optional	Optional	Optional



# Maschinenfabrik Bernard KRONE

Perfect in every detail

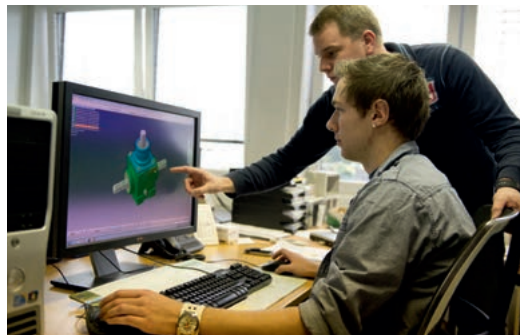

Innovative, proficient and close to our customers – these are the keywords that mark the philosophy of our family-owned company. As a forage specialist, KRONE manufactures disc mowers, tedders, rakes, forage wagons and silage trailers, round and square balers as well as the high-capacity and self-propelled BiG M mower conditioners and our BiG X forage harvesters. Quality made in Spelle – since 1906.

Your KRONE dealer



**Maschinenfabrik Bernard KRONE GmbH & Co. KG**

Heinrich-Krone-Straße 10  
D-48480 Spelle

Phone: +49 (0) 5977 935-0  
Fax: +49 (0) 5977 935-339

[info.ldm@krone.de](mailto:info.ldm@krone.de) | [www.krone.de](http://www.krone.de)