

OPERATOR'S MANUAL

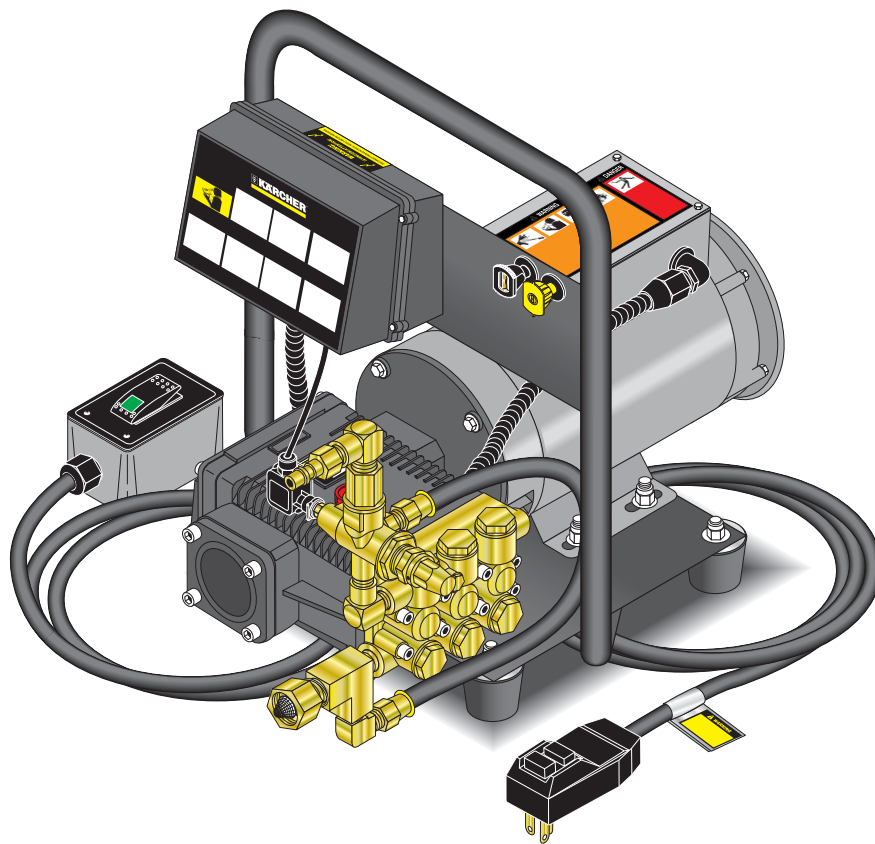

<u>MODEL</u>
HD 2.0/10 Ed
HD 1.8/14 Ed
HD 2.0/14Ed+

<u>ORDER #</u>
1.575-400.0
1.575-401.0
1.107-088.0

Important Safety Information	5-6
Component Identification	7
Assembly Instructions	8
Operating Instructions.....	9
Shutdown and Cleanup	10
Storage	10
Troubleshooting	11
Preventative Maintenance	12
Oil Change Record	12
Optional Wall Mount.....	13
Hose & Spray Gun Assembly & Parts List	14

Model Number _____

Serial Number _____

Date of Purchase _____

The model and serial numbers will be found on a decal attached to the pressure washer. You should record both serial number and date of purchase and keep in a safe place for future reference.

INTRODUCTION & IMPORTANT SAFETY INFORMATION

Thank you for purchasing this Pressure Washer. We reserve the right to make changes at any time without incurring any obligation.

Owner/User Responsibility:

The owner and/or user must have an understanding of the manufacturer's operating instructions and warnings before using this pressure washer. Warning information should be emphasized and understood. If the operator is not fluent in English, the manufacturer's instructions and warnings shall be read to and discussed with the operator in the operator's native language by the purchaser/owner, making sure that the operator comprehends its contents.

Owner and/or user must study and maintain for future reference the manufacturers' instructions.

The operator must know how to stop the machine quickly and understand the operation of all controls. Never permit anyone to operate the engine without proper instructions.

SAVE THESE INSTRUCTIONS

This manual should be considered a permanent part of the machine and should remain with it if machine is resold.

When ordering parts, please specify model and serial number. Use only identical replacement parts.

This machine is to be used only by trained operators.

IMPORTANT SAFETY INFORMATION



WARNING: To reduce the risk of injury, read operating instructions carefully before using.

1. Read the owner's manual thoroughly. Failure to follow instructions could cause malfunction of the machine and result in death, serious bodily injury and/or property damage.
2. Know how to stop the machine and bleed pressure quickly. Be thoroughly familiar with the controls.
3. Stay alert — watch what you are doing.
4. All installations must comply with local codes. Contact your electrician, plumber, utility company or the selling distributor for specific details. If your machine is rated 250 volts or less, single phase will be provided with a ground fault circuit interrupter (GFCI). If rated more than 250 volts, or more than single phase this product should only be connected to a power supply receptacle protected by a GFCI.

DANGER: Improper connection of the equipment-grounding conductor can result in a risk of electrocution. Check with a qualified electrician or service personnel if you are in doubt as to whether the outlet is properly grounded. Do not modify the plug provided with the product - if it will not fit the outlet, have a proper outlet installed by a qualified electrician. Do not use any type of adaptor with this product



WARNING: Keep wand, hose, and water spray away from electric wiring or fatal electric shock may result.

5. To protect the operator from electrical shock, the machine must be electrically grounded. It is the responsibility of the owner to connect this machine

to a UL grounded receptacle of proper voltage and amperage ratings. Do not spray water on or near electrical components. Do not touch machine with wet hands or while standing in water. Always disconnect power before servicing.



WARNING: Flammable liquids can create fumes which can ignite, causing property damage or severe injury.

WARNING: Risk of explosion — Do not spray flammable liquids.

6. Do not allow acids, caustic or abrasive fluids to pass through the pump.
7. Never run pump dry or leave spray gun closed longer than 1-2 minutes.
8. Keep operating area clear of all persons.



WARNING: High pressure spray can cause paint chips or other particles to become airborne and fly at high speeds. To avoid personal injury, eye, hand and foot safety devices must be worn.

9. Eye, hand, and foot protection must be worn when using this equipment.

IMPORTANT SAFETY INFORMATION

WARNING



TRIGGER GUN KICKS BACK - HOLD WITH BOTH HANDS

WARNING: Grip cleaning wand securely with both hands before starting. Failure to do this could result in injury from a whipping wand.

WARNING



RISK OF INJECTION OR SEVERE INJURY TO PERSONS. KEEP CLEAR OF NOZZLE.

WARNING: High pressure developed by these machines will cause personal injury or equipment damage. Keep clear of nozzle. Use caution when operating. Do not direct discharge stream at people, or severe injury or death will result.

10. To reduce the risk of injury, close supervision is necessary when a machine is used near children. Do not allow children to operate the pressure washer. **This machine must be attended during operation.**
11. Never make adjustments on machine while in operation.
12. Be certain all quick coupler fittings are secured before using pressure washer.

WARNING



PROTECT FROM FREEZING

WARNING: Protect machine from freezing.

13. To keep machine in best operating conditions, it is important you protect machine from freezing. Failure to protect machine from freezing could cause malfunction of the machine and result in death, serious bodily injury, and/or property damage. Follow storage instructions specified in this manual.

14. Inlet water must be clean fresh water and no hotter than 90°F.
15. Manufacturer will not be liable for any changes made to our standard machines or any components not purchased from us.
16. The best insurance against an accident is precaution and knowledge of the machine.

WARNING



RISK OF INJURY FROM FALLS WHEN USING LADDER.

WARNING: Be extremely careful when using a ladder, scaffolding or any other relatively unstable location. The cleaning area should have adequate slopes and drainage to reduce the possibility of a fall due to slippery surfaces.

17. Do not overreach or stand on unstable support. Keep good footing and balance at all times.
18. Do not operate this machine when fatigued or under the influence of alcohol, prescription medications, or drugs.



Follow the maintenance instructions specified in the manual.

Warning: Do not spray machine or any other electrical part.

Warning: Must be plugged into properly wired three hole grounded outlet that accommodates plug on power cord. Failure to comply could result in electrical shock.

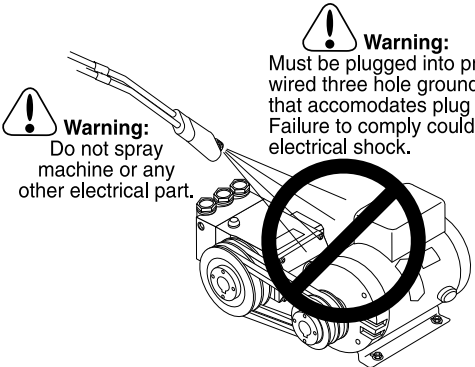

COMPONENT IDENTIFICATION

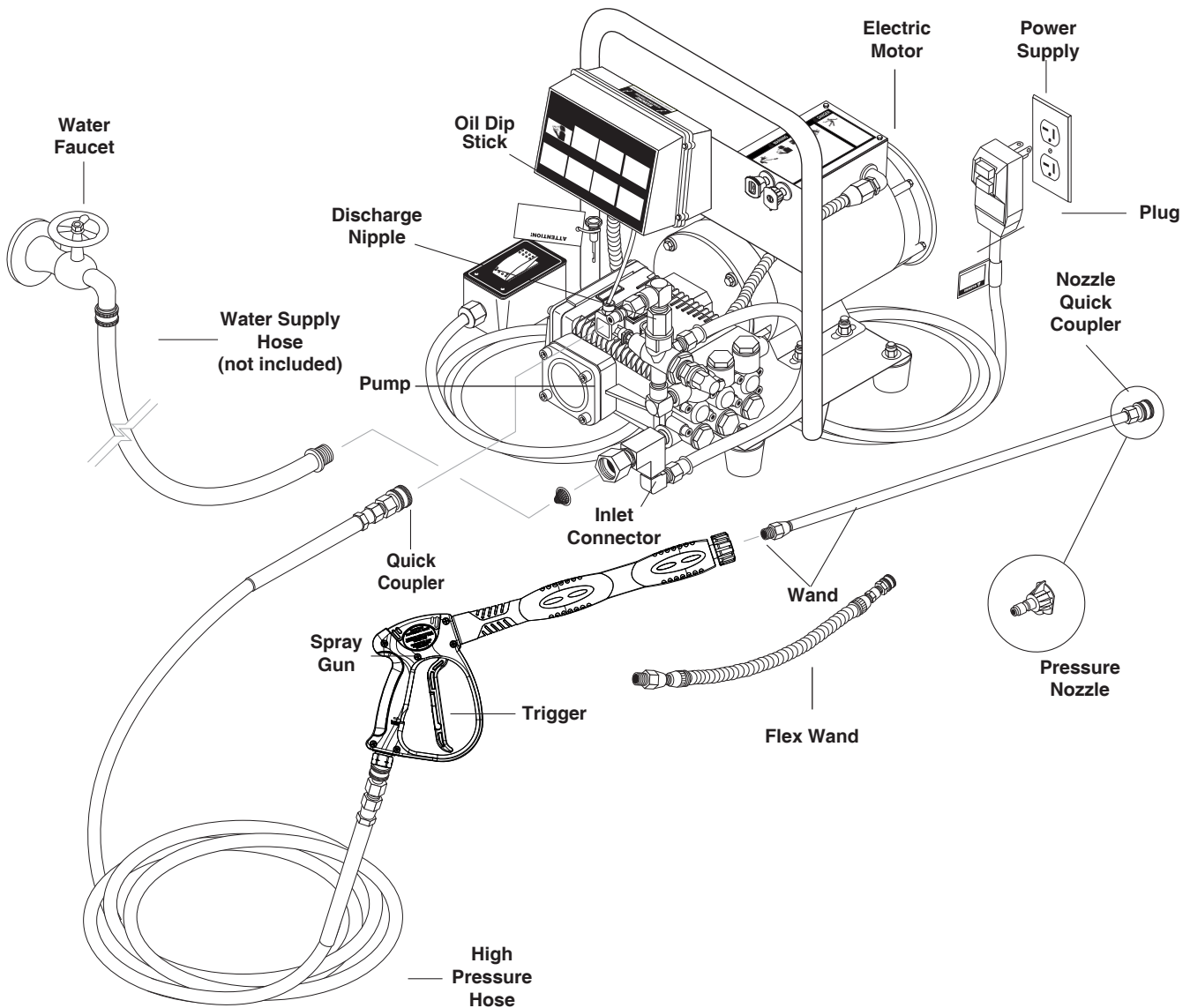

High Pressure Hose - Connect one end to water pump discharge nipple and the other end to spray gun.

Nozzle Quick Coupler - Allows quick change of nozzles.

Pump - Develops high pressure.

Spray Gun - Controls the application of water and detergent onto cleaning surface with trigger device. Includes safety latch.

Wand - Must be connected to the spray gun.

Flex Wand - Allows operator flexibility in spray angle. (Standard on PLUS models only).

ASSEMBLY INSTRUCTIONS

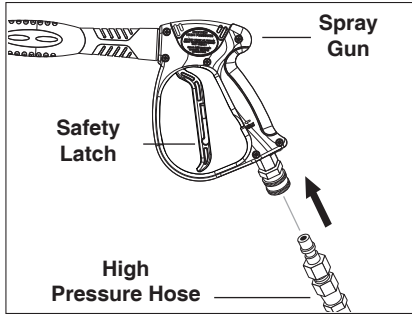

STEP 1: Attach the high pressure hose to the spray gun with quick coupler.

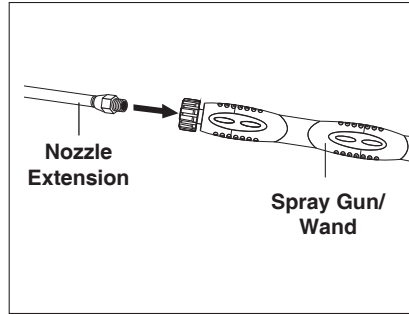

STEP 2: Attach nozzle extension to spray gun/wand. Tighten both by hand.

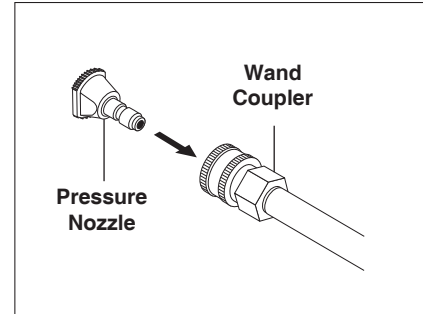

STEP 3: Pull the spring-loaded collar of the wand coupler back to insert your choice of pressure nozzle.

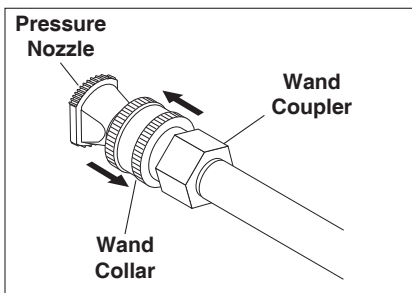

STEP 4: Release the coupler collar and push the nozzle until the collar clicks. Pull the nozzle to make sure it is seated properly.

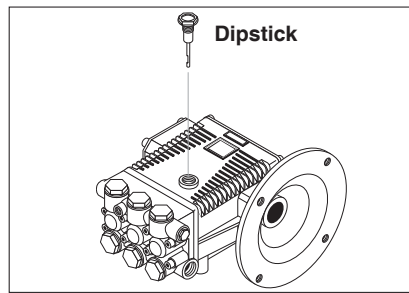

STEP 5: Remove shipping cap and install oil dipstick. Check pump oil level by using dipstick. Use 40 wt. non detergent oil.

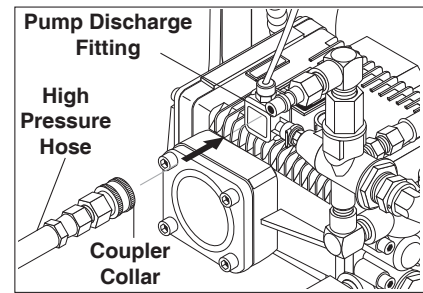

STEP 6: Connect the high pressure hose to the pump discharge fitting. Push coupler collar forward until secure.

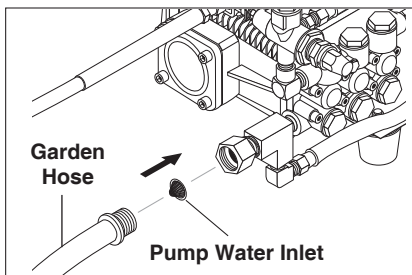

STEP 7: Connect the garden hose to pump inlet. Inspect inlets.

CAUTION: Do not run the pump without water or pump damage will result.

OPERATING INSTRUCTIONS

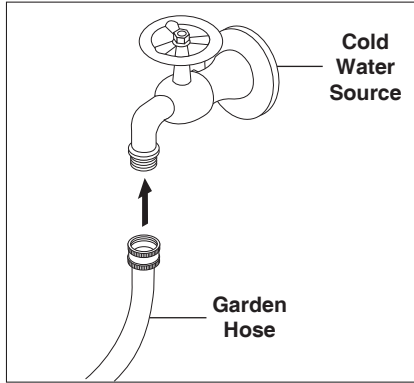

STEP 1: Connect garden hose to the cold water source and turn water on completely. Never use hot water.

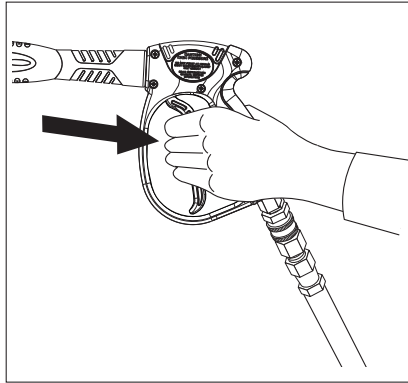

STEP 2: Trigger the spray gun to eliminate trapped air then wait for a steady flow of water to emerge from the spray nozzle.

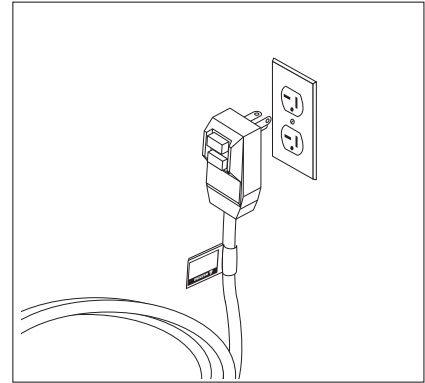

STEP 3: Connect to appropriate power supply.

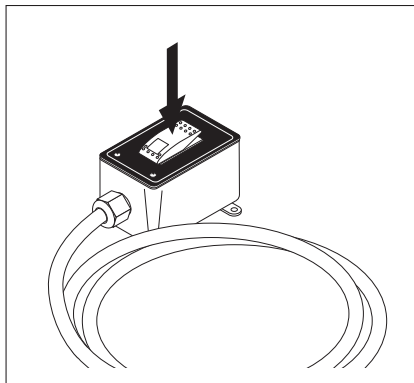

STEP 4: Turn machine on by pressing remote control box (if equipped) or by flipping the switch at the rear of the motor and by triggering the spray gun.

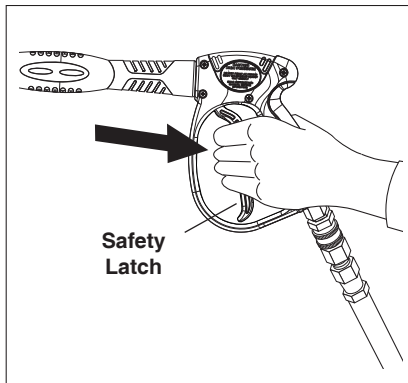

⚠ WARNING! Never replace nozzles without engaging the safety latch on the spray gun trigger.

SHUTTING DOWN AND CLEAN-UP

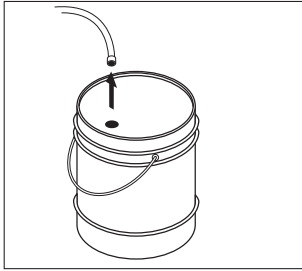

STEP 1: Remove detergent suction tube from container and insert into one gallon of fresh water. Slide nozzle forward for low pressure or to connect black detergent nozzle. Pull trigger on spray gun and siphon water for one minute.

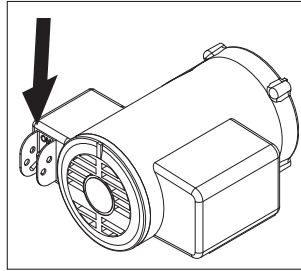

STEP 2: Turn off machine by flipping switch on rear of motor or by pressing the switch on the remote control box (if equipped).

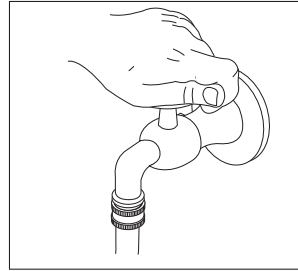

STEP 3: Turn off water supply.

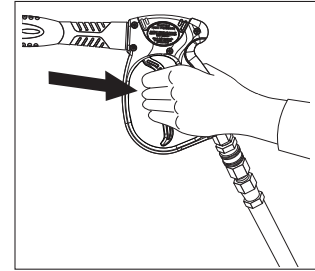

STEP 4: Press trigger to release water pressure.

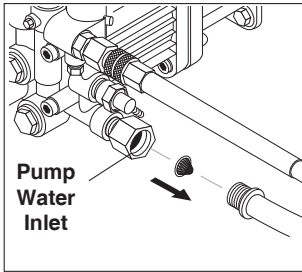

STEP 5: Disconnect the garden hose from the water inlet on the machine.

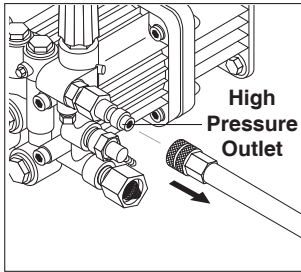

STEP 6: Disconnect the high pressure hose from high pressure outlet.

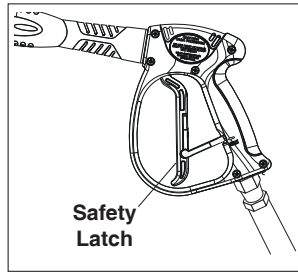

STEP 7: Engage the spray gun safety lock.

STORAGE

Pump Storage



CAUTION

CAUTION: Always store your pressure washer in a location where the temperature will not fall below 32° F (0° C). The pump in this machine is susceptible to permanent damage if frozen.

FREEZE DAMAGE IS NOT COVERED BY WARRANTY.

If you must store your pressure washer in a location where the temperature is below 32° F, you can minimize the chance of damage to your machine by draining your machine as follows:

1. Stop the pressure washer and detach supply hose and high pressure hose. Squeeze the trigger of the spray gun to drain all water from the wand and hose.
2. Restart pressure washer and let it run briefly (about 5 seconds) until water no longer discharges from the high pressure outlet.

TROUBLESHOOTING

PROBLEM	POSSIBLE CAUSE	SOLUTION
PUMP RUNNING NORMALLY BUT PRESSURE LOW ON INSTALLATION	Pump sucking air	Check water supply and possibility of air seepage.
	Check valves sticking	Check and clean or replace if necessary.
	Unloader valve seat faulty	Check and replace if necessary.
	Nozzle incorrectly sized	Check and replace if necessary.
	Worn piston packing	Check and replace if necessary.
FLUCTUATING PRESSURE	Valves worn	Check and replace if necessary.
	Blockage in valve	Check and replace if necessary.
	Pump sucking air	Check water supply connections.
	Worn piston packing	Check and replace if necessary.
	Insufficient water	Check filter and hose for breakage/clogging
PRESSURE LOW AFTER PERIOD OF NORMAL USE	Nozzle worn	Check and replace if necessary.
	Suction or delivery valves worn	Check and replace if necessary.
	Suction or delivery lines blocked	Check and clean if necessary.
	Unloader valve seat worn	Check and replace if necessary.
	Worn piston package	Check and replace if necessary.
	Water temperature excessive	Reduce to below 140° F.
PUMP NOISY	Air in suction line	Check water supply and connections on suction line.
	Broken or weak suction or delivery valve spring.	Check and replace if necessary.
	Foreign matter in valves	Check and clean if necessary.
	Worn bearings	Check and replace if necessary.
	Water temperature excessive	Reduce to below 160° F.
PRESENCE OF WATER IN PUMP OIL	Oil seal worn	Check and replace if necessary.
	High humidity in air	Check and replace if necessary.
	Piston packing worn	Check and replace if necessary.
WATER DRIPPING FROM UNDER PUMP	Piston packing worn	Check and replace if necessary.
	O-ring plunger retainer worn	Check and replace if necessary.
WATER DRIPPING FROM PUMP PROTECTOR	Water supply pressure too high (over 90 psi)	Lower water supply pressure using regulator.
	Spray gun is in the off position for over 1-2 minutes	Turn machine off if not in use for over 1-2 minutes.
OIL DRIPPING	Oil seal worn	Check and replace if necessary.
EXCESSIVE VIBRATION IN HIGH PRESSURE HOSE	Irregular functioning of the pump valves	Check and replace if necessary.
MOTOR DOES NOT START WHEN SWITCHED ON	Plug not well connected or lack of power supply	Check plug, cable and switch.
WHEN SWITCHING ON THE MACHINE, MOTOR HUMS BUT DOES NOT RUN	Main voltage is insufficient, lower than the minimum required.	Check to make sure main power supply is adequate.
	The pump is stuck or frozen	Check by turning the motor manually.
MOTOR STOPS	Tripped thermal overload due to overheating	Check that main voltage corresponds to specifications for the machine. Wait a few minutes before turning on the machine again by resetting the GFCI on the cord.

PREVENTATIVE MAINTENANCE

This pressure washer was produced with the best available materials and quality craftsmanship. However, you as the owner have certain responsibilities for the correct care of the equipment. Attention to regular preventative maintenance procedures will assist in preserving the performance of your equipment. Contact your dealer for maintenance. Regular preventative maintenance will add many hours to the life of your pressure washer. Perform maintenance more often under severe conditions.

Pump Oil	Inspect	Daily, Inspect the oil level
	Change	After first 50 hours, then every 500 hours or annually
Replace High Pressure Nozzle		Every 6 months
Replace Quick Connects		Annually
Replace Clean Water Screen/Filter		Weekly
Replace HP Hose		Annually if there is any sign of wear
Grease Motor		Every 10,000 hours or annually

General Inspection

Inspect the motor at regular intervals, approximately every 500 hours of operation, or every 3 months, whichever occurs first. Keep the motor clean and the ventilation openings clear. The following steps should be performed at each inspection:

WARNING: Do not touch electrical connections before you first ensure that power has been disconnected. Electrical shock can cause serious or fatal injury. Only qualified personnel should attempt the installation, operation and maintenance of this equipment.

1. Check that the motor is clean. Check that the interior and exterior of the motor is free of dirt, oil, grease, water, etc. Oily vapor, paper pulp, textile lint, etc. can accumulate and block motor ventilation. If the motor is not properly ventilated overheating can occur and cause early motor failure.
2. Check all electrical connectors to be sure that they are tight.

Lubrication & Bearings

Bearing grease will lose its lubricating ability over time, not suddenly. The lubricating ability of a grease (over time) depends primarily on the type of grease, the size of the bearing, the speed at which the bearing operates and the severity of the operating conditions. Good results can be obtained if the following recommendations are used in your maintenance program.

Type of Grease

A high grade ball or roller bearing grease should be used. Recommended greases standard service conditions are: Shell Dolium R (Factory installed) or Chevron SRI.

OIL CHANGE RECORD

Date Oil Changed Month/Day/Year	Estimated Operating Hours Since Last Oil Change	Date Oil Changed Month/Day/Year	Estimated Operating Hours Since Last Oil Change

OPTIONAL WALL MOUNT - 8.903-613.0

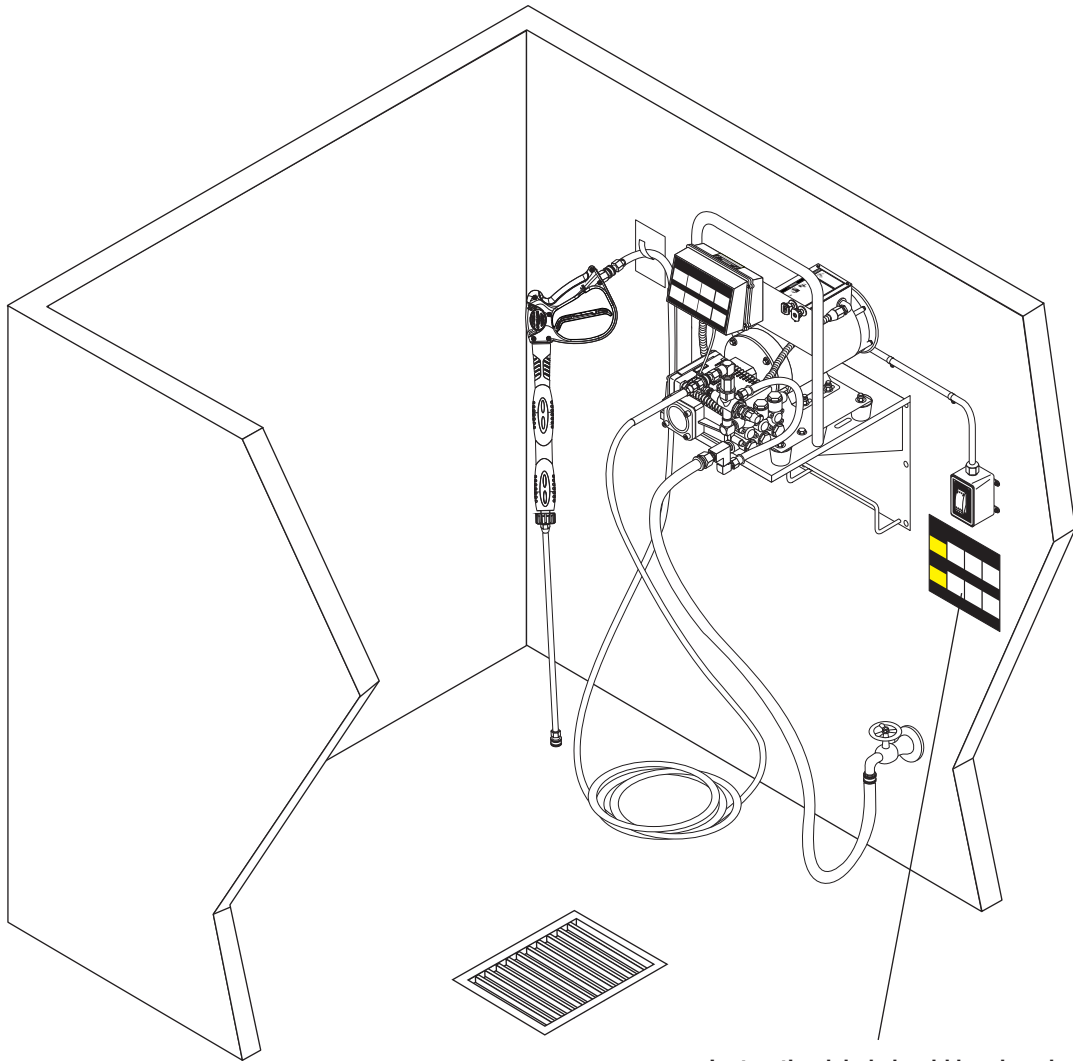

Instruction label should be placed next to the machine and within easy view of all users.

HOSE & SPRAY GUN ASSEMBLY

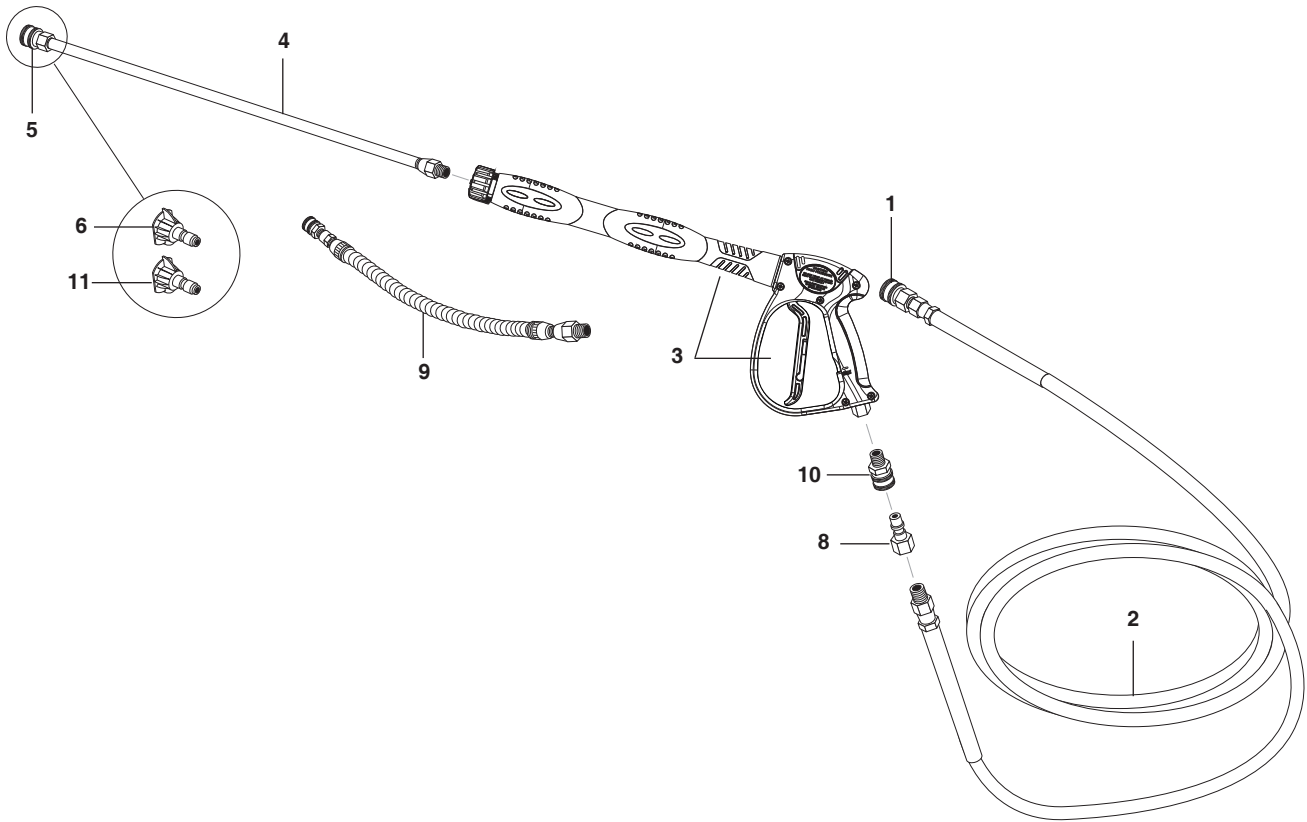

HOSE & SPRAY GUN ASSEMBLY PARTS LIST

ITEM	PART NO.	DESCRIPTION	QTY	ITEM	PART NO.	DESCRIPTION	QTY
1	9.802-166.0	Coupler, 3/8" Female	1	5	9.802-164.0	Coupler, 1/4" Female	1
	9.802-100.0	▲ Quick Coupler O-Ring	1		9.802-096.0	▲ Quick Coupler O-Ring	1
2	8.739-133.0	Hose, 3/8" x 25', LA 1-wire, Tuff-Skin (ZE and ZEF models)	1	6	9.802-296.0	Nozzle, 4.0 15° Yellow (Remote Switch Option)	1
	8.739-106.0	Hose, 3/8" x 25', 1-wire, HO, Tuff Skin (ET models)	1		9.802-288.0	Nozzle, 3.0 15° Yellow (1400 PSI AXD/BXD)	1
	8.739-124.0	Hose, 3/8" x 25', 1-wire, KA, Tuff Skin (HD and HE)	1		9.804-624.0	Nozzle, 3.75 15° Yellow (1000 PSI AXD/BXD)	1
3	8.754-769.0	Spray Gun, Shut-Off	1	8	9.802-170.0	Nipple, 3/8" NPT Female	1
4	9.802-220.0	Wand, Straight	1	9	8.904-449.0	Flex Wand Assembly (ZE2-14024D Models)	1
				10	9.802-169.0	Coupler, 3/8 Male	1
				11	8.712-398.0	Nozzle, Soap Black	1

▲ Not Shown



www.karchercommercial.com

Form # 9.800-088.0 • Revised 11/15 • Printed in U.S.A. or Mexico