

KÄRCHER

makes a difference

Pressure Washer - HD Cold Water - Electric Powered

English

02



To locate your local Kärcher
Commercial Pressure Washer
Dealer nearest you, visit
www.karchercommercial.com



**Register
your product**
www.karcher.com/welcome



9.800-086.0 - AF 10/11/21

Machine Data Label

Model: _____

Date of Purchase: _____

Serial Number: _____

Dealer: _____

Address: _____

Phone Number: _____

Sales Representative: _____

MODELS:

HD 2.8/10 ST Ed B
1.575-300.0

HD 4.2/20 ST Ea B
1.575-301.0

HD 4.2/20 ST Eb B
1.575-302.0

HD 4.2/20 ST Ec B
1.575-303.0

HD 4.2/20 ST Eh B
1.575-305.0

HD 3.5/30 ST Ea B
1.575-306.0

HD 3.5/30 ST Eb B
1.575-307.0

HD 3.5/30 ST Ec B
1.575-308.0

HD 3.5/30 ST Eg B
1.575-309.0

HD 3.5/30 ST Eh B
1.575-310.0

.....1
Machine Data Label2
Table of Contents3
How To Use This Manual4

Safety

Introduction & Safety Information5
Important Safety Information.....6

Operations

Component Identification8
Assembly Instructions9
Operating Instructions10
Detergents And General Operating Techniques...11
Shutting Down And Clean-Up.....12
Storage13

Maintenance

Preventative Maintenance14
Maintenance Schedule14
Oil Change Record14
Troubleshooting15

Parts

Karcher HD18
Hose & Spray Gun24
Multi-Room Installation25
Specifications26
Pump.....28
KBP Series Pump30
KM.3 Series Pump32
VB8 Unloader Valve34
VRT3 Unloader36

How To Use This Manual

This manual contains the following sections:

- How to Use This Manual
- Safety
- Operations
- Maintenance
- Parts List

The HOW TO USE THIS MANUAL section will tell you how to find important information for ordering correct repair parts.

Parts may be ordered from authorized dealers. When placing an order for parts, the machine model and machine serial number are important. Refer to the MACHINE DATA box which is filled out during the installation of your machine. The MACHINE DATA box is located on the inside of the front cover of this manual.

Model: _____
Date of Purchase: _____
Serial Number: _____
Dealer: _____
Address: _____
Phone Number: _____
Sales Representative: _____

The model and serial numbers will be found on a decal attached to the pressure washer.

The SAFETY section contains important information regarding hazardous or unsafe practices of the machine. Levels of hazards are identified that could result in product damage, personal injury, or severe injury resulting in death.

The OPERATIONS section is to familiarize the operator with the operation and function of the machine.

The MAINTENANCE section contains preventive maintenance to keep the machine and its components in good working condition. They are listed in this general order:

- Preventative Maintenance
- Oil Changing Record
- Troubleshooting

The PARTS LIST section contains assembled parts illustrations and corresponding parts list. The parts lists include a number of columns of information:

- **REF** – column refers to the reference number on the parts illustration.
- **PART NO.** – column lists the part number for the part.
- **QTY** – column lists the quantity of the part used in that area of the machine.
- **DESCRIPTION** – column is a brief description of the part.
- **NOTES** – column for information not noted by the other columns.

NOTE: If a service or option kit is installed on your machine, be sure to keep the KIT INSTRUCTIONS which came with the kit. It contains replacement parts numbers needed for ordering future parts.

NOTE: The manual part number is located on the lower right corner of the front cover.

Introduction & Safety Information

Thank you for purchasing this Pressure Washer. We reserve the right to make changes at any time without incurring any obligation.

Owner/User Responsibility:

The owner and/or user must have an understanding of the manufacturer's operating instructions and warnings before using this pressure washer. Warning information should be emphasized and understood. If the operator is not fluent in English, the manufacturer's instructions and warnings shall be read to and discussed with the operator in the operator's native language by the purchaser/owner, making sure that the operator comprehends its contents.

Owner and/or user must study and maintain for future reference the manufacturers' instructions.

The operator must know how to stop the machine quickly and understand the operation of all controls. Never permit anyone to operate the engine without proper instructions.

SAVE THESE INSTRUCTIONS

This manual should be considered a permanent part of the machine and should remain with it if machine is resold.

When ordering parts, please specify model and serial number. Use only identical replacement parts.

This machine is to be used only by trained operators.

Important Safety Information



WARNING: To reduce the risk of injury, read operating instructions carefully before using.

AVERTISSEMENT: Pour réduire le risque de blessures, lire attentivement les instructions de fonctionnement avant l'utilisation.

1. Read the owner's manual thoroughly. Failure to follow instructions could cause malfunction of the machine and result in death, serious bodily injury and/or property damage.
2. Know how to stop the machine and bleed pressure quickly. Be thoroughly familiar with the controls.
3. Stay alert — watch what you are doing.
4. All installations must comply with local codes. Contact your electrician, plumber, utility company or the selling dealer for specific details. If your machine is rated 250 volts or less, single phase a ground fault circuit interrupter (GFCI) will be provided. If rated more than 250 volts, or more than single phase this product should only be connected to a power supply protected by a GFCI.

DANGER: Improper connection of the equipment-grounding conductor can result in a risk of electrocution. Check with a qualified electrician or service personnel if you are in doubt as to whether the outlet is properly grounded. Do not modify the plug provided with the product - if it will not fit the outlet, have a proper outlet installed by a qualified electrician. Do not use any type of adapter with this product.

AVERTISSEMENT: Une mauvaise connexion du conducteur de terre de l'équipement peut entraîner un risque d'électrocution. Vérifier auprès d'un électricien qualifié ou du personnel d'entretien si vous avez des doutes quant à savoir si la sortie est correctement mise à la masse. NE PAS modifier la fiche fournie avec le produit - si elle n'entre pas dans la sortie, faire installer une sortie appropriée par un électricien qualifié. NE JAMAIS utiliser un adaptateur avec ce produit.



WARNING: Keep wand, hose, and water spray away from electric wiring or fatal electric shock may result.

AVERTISSEMENT: Garder la lance, le boyau et le jet d'eau à l'écart de tout câblage électrique ou des chocs électriques mortels pourraient survenir

5. To protect the operator from electrical shock, the machine must be electrically grounded. It is the responsibility of the owner to connect this machine to a UL grounded receptacle of proper voltage and amperage ratings. Do not spray water on or near electrical components. Do not touch machine with wet hands or while standing in water. Always disconnect power before servicing.

WARNING: Flammable liquids can create fumes which can ignite, causing property damage or severe injury.

AVERTISSEMENT: Des liquides inflammables peuvent produire des vapeurs qui peuvent s'enflammer, causant ainsi des dommages à la propriété ou des blessures graves.



WARNING: Risk of explosion — Do not spray flammable liquids.

AVERTISSEMENT: Risque d'explosion - Ne pas pulvériser de liquides inflammables.

6. Do not allow acids, caustic or abrasive fluids to pass through the pump.
7. Never run pump dry or leave spray gun closed longer than 1-2 minutes.
8. Keep operating area clear of all persons.



WARNING: High pressure spray can cause paint chips or other particles to become airborne and fly at high speeds. To avoid personal injury, eye, hand and foot safety devices must be worn.

AVERTISSEMENT: Un jet haute pression peut écailler la peinture ou provoquer l'émission d'autres particules dans l'air et leur

projection à hautes vitesses.

9. Always wear properly rated eye protection such as safety goggles or face shield while spraying. (Safety glasses do not provide full protection.)



WARNING: Grip cleaning wand securely with both hands before starting. Failure to do this could result in injury from a whipping wand.

AVERTISSEMENT: Agripper la lance de nettoyage avec les deux mains avant de commencer. Le non-respect de cette consigne pourrait mener à des blessures causées par le mouvement violent de la lance.



WARNING: High pressure developed by these machines will cause personal injury or equipment damage. Keep clear of nozzle. Use caution when operating. Do not direct discharge stream at people or animals or severe injury or death will result.

AVERTISSEMENT: La haute pression générée par la laveuse à pression raccordée au NG-3000 causera des lésions corporelles ou des dommages à l'équipement. Se tenir à l'écart de la buse. Faire preuve de prudence lors de l'utilisation. Ne pas décharger directement le jet vers des personnes ou des animaux, car cela risquerait de causer des blessures graves ou même la mort.

10. To reduce the risk of injury, close supervision is necessary when a machine is used near children. Do not allow children to operate the pressure washer. **This machine must be attended during operation.**
11. Never make adjustments on machine while in operation.
12. Be certain all quick coupler fittings are secured before using pressure washer.



WARNING: Protect machine from freezing.
AVERTISSEMENT: Protéger la machine contre le gel.

13. To keep machine in best operating conditions, it is important you protect machine from freezing. Failure to protect machine from freezing could

cause malfunction of the machine and result in death, serious bodily injury, and/or property damage. Follow storage instructions specified in this manual.

14. Inlet water must be clean fresh water and no hotter than 185°F.
15. Manufacturer will not be liable for any changes made to our standard machines or any components not purchased from us.
16. The best insurance against an accident is precaution and knowledge of the machine.



WARNING: Be extremely careful when using a ladder, scaffolding or any other relatively unstable location. The cleaning area should have adequate slopes and drainage to reduce the possibility of a fall due to slippery surfaces.

AVERTISSEMENT: Faire preuve d'une extrême prudence au moment d'utiliser une échelle, des échafaudages ou toute autre surface relativement instable. La zone de nettoyage doit avoir une pente et un drainage adéquats pour réduire la possibilité d'une chute due à une surface glissante.

17. Do not overreach or stand on unstable support. Keep good footing and balance at all times.
18. Do not operate this machine when fatigued or under the influence of alcohol, prescription medications, or drugs.



WARNING: Do not spray machine or any people, animals or electrical parts.

AVERTISSEMENT: Ne pas vaporiser sur la machine ou les gens, les animaux ou les pièces électriques



WARNING: If connection is made to a potable water system, the system shall be protected against back flow.

AVERTISSEMENT: Si une connexion est établie avec un réseau d'eau potable, le réseau doit être protégé contre le retour d'eau.



Follow the maintenance instructions specified in the manual.

Suivre les instructions d'entretien spécifiées dans le manuel.

Operations

Component Identification

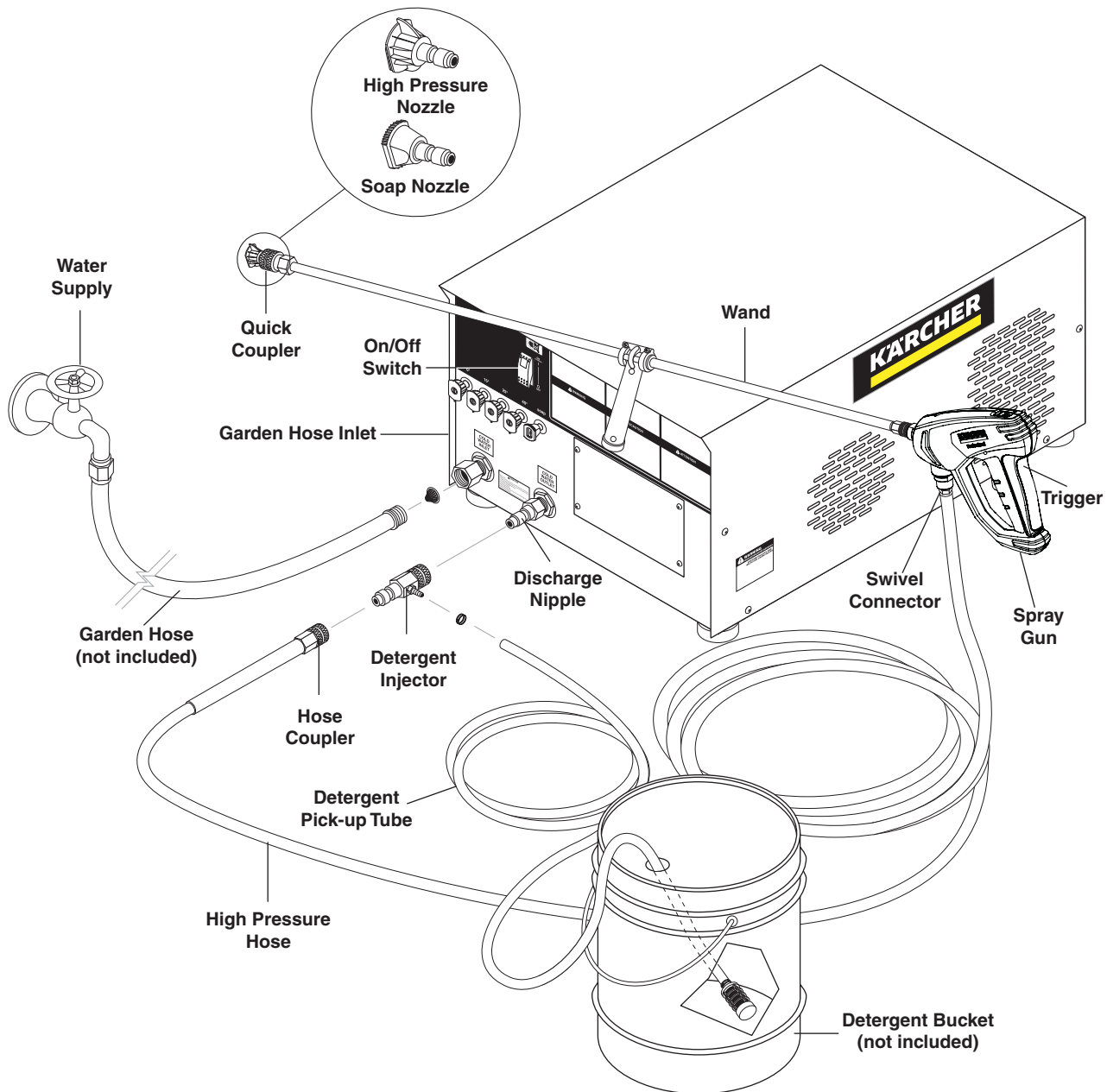

Detergent Injector - Allows you to siphon and mix detergents, when used with soap nozzle.

High Pressure Hose — Connect one end to water pump discharge nipple and the other end to spray gun.

Spray Gun — Controls the application of water and detergent onto cleaning surface with trigger device. Includes safety latch.

Wand — Must be connected to the spray gun.

Swivel Connector - Allows free range of movement to avoid coiling hoses.

NOTE: *If trigger on spray gun is released for more than 2 minutes, water will leak from pump protector valve. Warm water will discharge onto floor and cool water will allow the pump protector to seal. This system prevents internal pump damage.*

Assembly Instructions

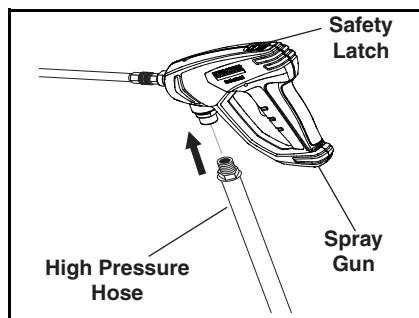

STEP 1: Attach the high pressure hose to the spray gun using teflon tape on hose threads. Use safety latch to prevent from opening.

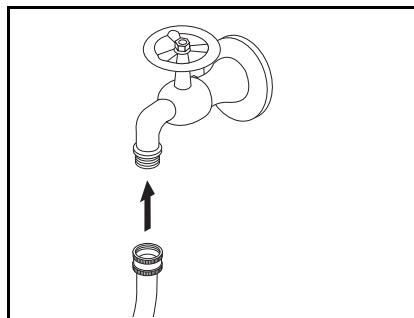

STEP 2: Connect garden hose to the cold water source. Before installing nozzle, turn on water supply and run machine, allowing water to flush through the system until clear.

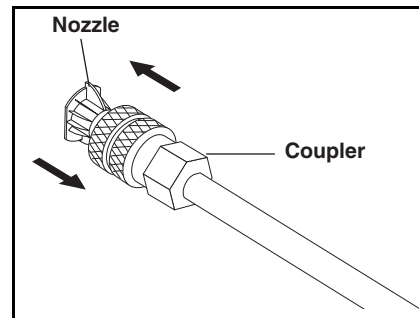

STEP 3: Insert nozzle into coupler. Release the coupler collar and push the nozzle until the collar clicks. Pull the nozzle to make sure it is seated properly.

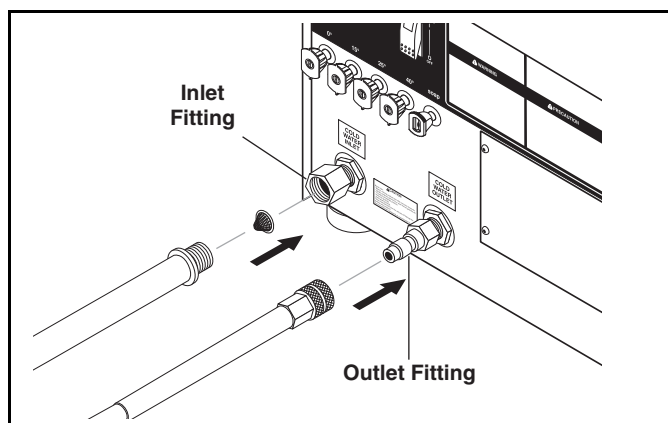

STEP 4: Connect the high pressure hose to the outlet discharge fitting. Push coupler collar forward until secure. Connect the garden hose to pump water inlet. Inspect inlets.
CAUTION: Do not run the pump without water or pump damage will result.

ATTENTION: Ne coulez pas la pompe sans eau ou des dégâts de pompe se produiront.

Operations

Operating Instructions

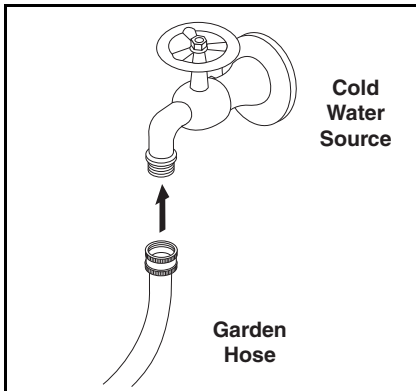

STEP 1: Connect garden hose to the cold water source and turn water on completely. Never use hot water.

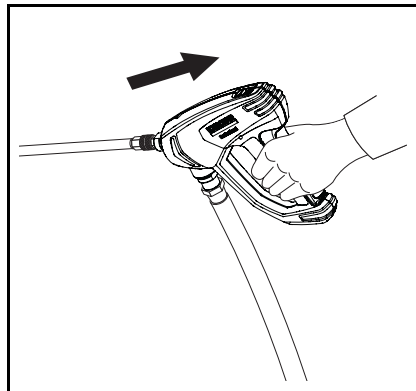

STEP 2: Trigger the spray gun to eliminate trapped air then wait for a steady flow of water to emerge from the spray wand. Then install nozzle.

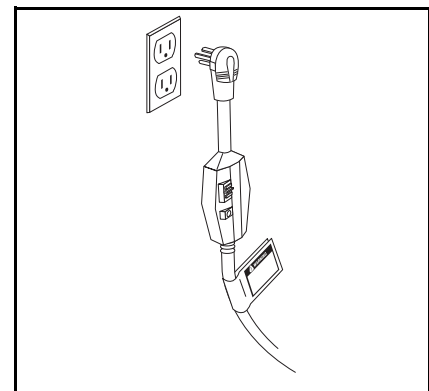

STEP 3: Connect to appropriate power supply. Push GFCI reset button.

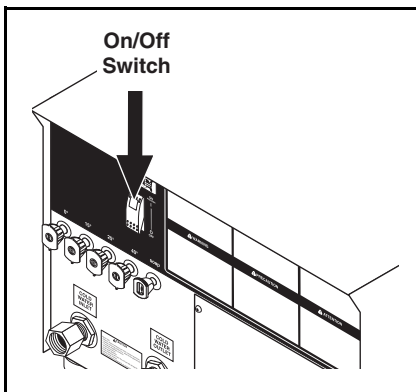

STEP 4: Turn machine on by pushing switch at front of machine.

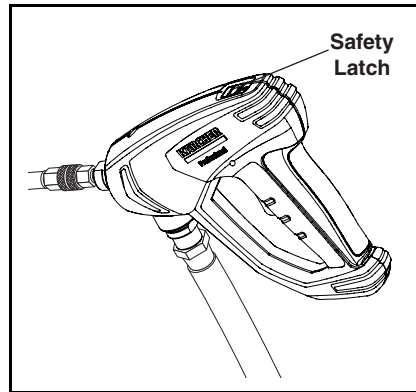

⚠ WARNING! Never replace nozzles without engaging the safety latch on the spray gun trigger.

⚠ AVERTISSEMENT: Ne jamais remplacer les buses sans d'abord mettre le dispositif de sécurité sur la détente du pistolet pulvérisateur.

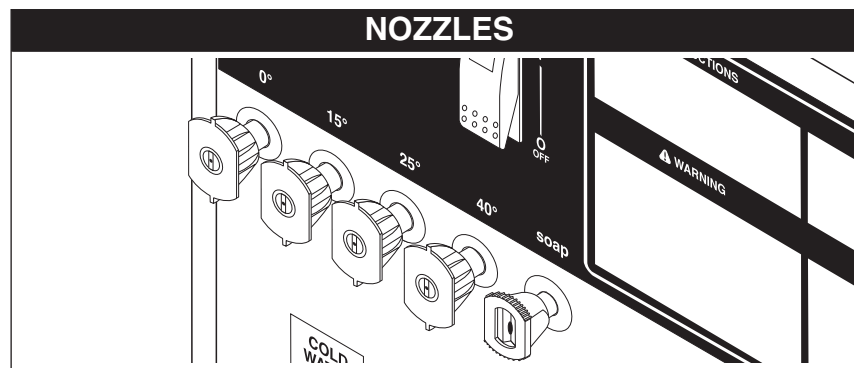

The five color-coded quick connect nozzles provide a wide array of spray widths from 0° to 40° and are easily accessible when placed in the convenient rubber nozzle holder, which is provided on the front of the machine.

NOTE: For a more gentle rinse, select the white 40° or green 25° nozzle. To scour the surface, select the yellow 15° or red 0° nozzle. To apply detergent select the black nozzle.

Detergents And General Operating Techniques

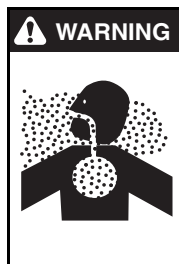

WARNING: Some detergents may be harmful if inhaled or ingested, causing severe nausea, fainting or poisoning. The harmful elements may cause property damage or severe injury.

AVERTISSEMENT: Certains détergents peuvent être dangereux s'ils sont inhalés ou ingérés, provoquant de

fortes nausées, des évanouissements et l'empoisonnement. Les éléments dangereux peuvent causer des dommages à la propriété ou des blessures graves

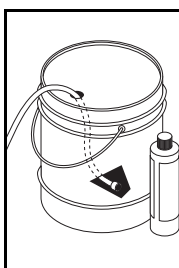

STEP 1: Use detergent designed specifically for pressure washers. Household detergents could damage the pump. Prepare detergent solution as required by the manufacturer. Fill a container with pressure washer detergent. Place the filter end of detergent suction tube into the detergent container.

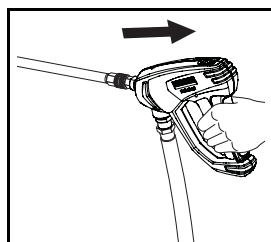
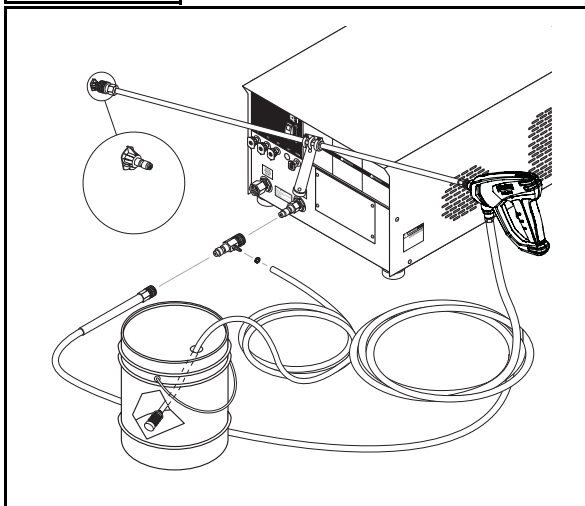

STEP 2: Apply safety latch to spray gun trigger. Secure black detergent nozzle into quick coupler. **NOTE:** Detergent cannot be applied using the Yellow nozzle.

STEP 3: With the motor running, pull trigger to operate machine. Liquid detergent is drawn into the

machine and mixed with water. Apply detergent to work area. Do not allow detergent to dry on surface.

IMPORTANT: You must flush the detergent injection system after each use by placing the suction tube into a bucket of clean water, then run the pressure washer in low pressure for 1-2 minutes.

Thermal Pump Protection

If you run your pressure washer for 2 minutes without pressing the trigger on the spray gun, circulating water in the pump can reach high temperatures. When the water reaches this temperature, the pump protector engages and cools the pump by discharging the warm water onto the ground. This thermal device prevents internal damage to the pump.

Cleaning Tips

Pre-rinse cleaning surface with fresh water. Place detergent suction tube directly into cleaning solution and apply to surface at low pressure (for best results, limit your work area to sections approximately 6' square and always apply detergent from bottom to top). Allow detergent to remain on surface 1-3 minutes. Do not allow detergent to dry on surface. If surface appears to be drying, simply wet down surface with fresh water. If needed, use brush to remove stubborn dirt. Rinse at high pressure from top to bottom in an even sweeping motion keeping the spray nozzle approximately 1' from cleaning surface. Use overlapping strokes as you clean and rinse any surface. For best surface cleaning action spray at a slight angle.

Recommendations:

- Before cleaning any surface, an inconspicuous area should be cleaned to test spray pattern and distance for maximum cleaning results.
- If painted surfaces are peeling or chipping, use extreme caution as pressure washer may remove the loose paint from the surface.
- Keep the spray nozzle a safe distance from the surface you plan to clean. High pressure wash a small area, then check the surface for damage. If no damage is found, continue to pressure washing.



CAUTION - Never use:

- Bleach, chlorine or other corrosive chemicals
- Liquids containing solvents (i.e., paint thinner, gasoline, oils)
- Tri-sodium phosphate products
- Ammonia products or acid-based products



ATTENTION: Ne jamais utiliser :

- Eau de Javel, produits à base de chlore et autres produits chimiques corrosifs
- Liquides contenant des solvants (c.-à-d. diluant à peinture, essence, huiles, etc.)
- Produits à base de tripolyphosphate de sodium
- Ammoniac ou produits à base d'acide

These chemicals will harm the machine and will damage the surface being cleaned.

Rinsing

It will take a few seconds for the detergent to clear. Apply safety latch to spray gun. Remove black soap nozzle from the quick coupler. Select and install the desired high pressure nozzle. **NOTE:** You can also stop detergent from flowing by simply removing detergent siphon tube from bottle.

Operations

Shutting Down And Clean-Up

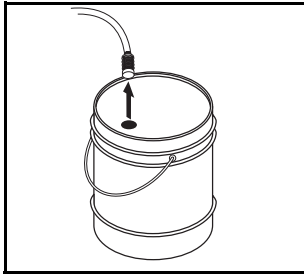

STEP 1: Remove detergent suction tube from soap container and insert into one gallon of fresh water. Use black soap nozzle with detergent injector. Pull trigger on spray gun and siphon water for one minute.

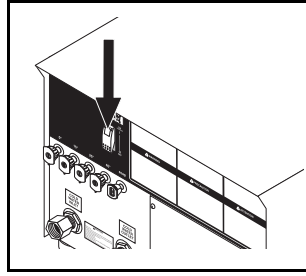

STEP 2: Turn off machine by pushing switch on front panel.

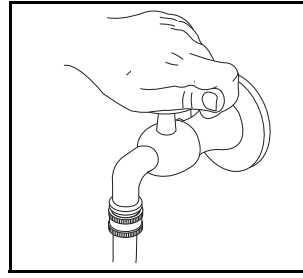

STEP 3: Turn off water supply.

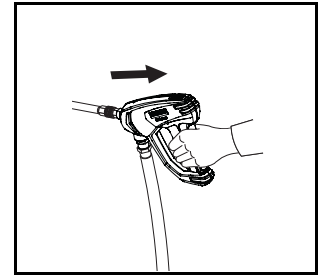

STEP 4: Press trigger to release water pressure.

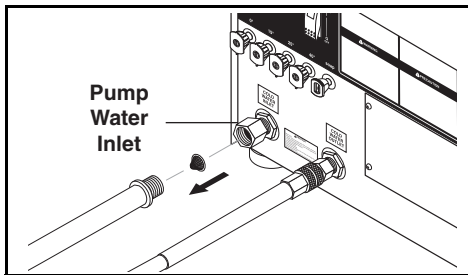

STEP 5: Disconnect the garden hose from the water inlet on the machine. Protect from freezing.

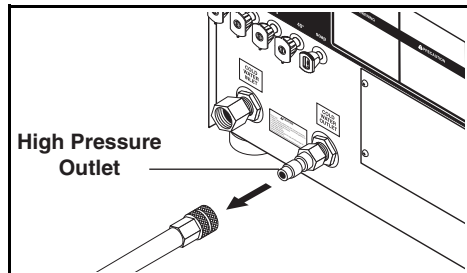

STEP 6: Disconnect the high pressure hose from high pressure outlet.

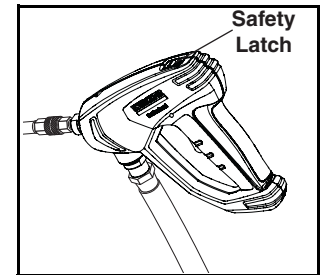

STEP 7: Engage the spray gun safety lock.

Storage

Pump Storage



CAUTION: Always store your pressure washer in a location where the temperature will not fall below 32° F (0° C). The pump in this machine is susceptible to permanent damage if frozen.

ATTENTION: Toujours entreposer la laveuse à pression dans un endroit où la température ne sera pas inférieure à 0 °C (32 °F). La pompe sur cette machine est susceptible de subir des dommages si elle est exposée au gel.

FREEZE DAMAGE IS NOT COVERED BY WARRANTY.

If you must store your pressure washer in a location where the temperature is below 32° F, you can minimize the chance of damage to your machine by draining your machine as follows:

1. Stop the pressure washer and detach supply hose and high pressure hose. Squeeze the trigger of the spray gun to drain all water from the wand and hose.
2. Restart pressure washer and let it run briefly (about 5 seconds) until water no longer discharges from the high pressure outlet.

Troubleshooting

PROBLEM	POSSIBLE CAUSE	SOLUTION
PUMP RUNNING NORMALLY BUT PRESSURE LOW ON INSTALLATION	Pump sucking air	Check water supply and possibility of air.
	Check valves sticking	Check and clean or replace if necessary.
	Unloader valve seat faulty	Check and replace if necessary.
	Nozzle incorrectly sized	Check and replace if necessary.
	Worn piston packing	Check and replace if necessary.
FLUCTUATING PRESSURE	Valves worn	Check and replace if necessary.
	Blockage in valve	Check and clean if necessary.
	Pump sucking air	Check water supply connections.
	Worn piston packing	Check and replace if necessary.
	Insufficient water	Check filter and hose for breakage.
PRESSURE LOW AFTER PERIOD OF NORMAL USE	Nozzle worn	Check and replace if necessary.
	Suction or delivery valves worn	Check and replace if necessary.
	Suction or delivery valves blocked	Check and clean if necessary.
	Unloader valve seat worn	Check and replace if necessary.
	Unloader adjusted improperly	Call local Karcher dealer. Tampering with the factory setting may cause personal injury and/or property damage and will void the manufacturer's warranty.
	Worn piston packing	Check and replace if necessary.
PUMP NOISY	Bypass valve within unloader is obstructed or leaking	Remove and clean bypass cartridge.
	Air in suction line	Check water supply and connections on suction line.
	Broken or weak suction or delivery valve spring	Check and replace if necessary.
	Foreign matter in valves	Check and clean if necessary.
	Worn bearings	Check and clean if necessary.
PRESENCE OF WATER IN PUMP OIL	Excessive temperature of water	Reduce to below 140°F.
	Oil seal worn	Check and replace if necessary.
	High humidity in air	Check and change oil twice as often.
	Piston packing worn	Check and replace if necessary.
WATER DRIPPING FROM UNDER PUMP	Piston packing worn	Check and replace if necessary.
	O-Ring plunger retainer worn	Check and replace if necessary.
OIL DRIPPING FROM PUMP	Oil seal worn	Check and replace if necessary.
EXCESSIVE VIBRATION IN HIGH PRESSURE HOSE	Irregular functioning of the pump valves	Check and replace if necessary.
	Obstruction in filter	Clean inlet filter.
MOTOR WILL NOT RUN	Motor overload	Push in the overload button located on the motor (single phase) or the overload button on the magnetic start switch (three phase).
	Step down transformer fuses	Check fuses and voltage. Replace if necessary.
	Coil of magnetic starter defective	Replace coil after the timer and unloader switch have been tested.
MACHINE WILL NOT TURN ON WHEN SWITCH IS PUSHED	Timer is defective	Join wires 15 and 16 together on timer. If machine works, replace timer.

