



Accessories for ECHO products can be found at:
*Pour obtenir des accessoires pour les produits
ECHO, consulter notre catalogue d'accessoires à:*
<http://www.echo.ca/products/catalogs>

PARTS CATALOG
NOMENCLATURE DES PIÈCES

DPB-2500
Handheld Blower
DPB-2500 Souffleur à main



SERIAL NUMBER
NUMÉRO DE SÉRIE

402BPH000001 - 402BPH999999

ECHO Incorporated

400 Oakwood Road, Lake Zurich, Illinois 60047

WWW.ECHO-USA.COM

©2023 ECHO Incorporated. All Rights Reserved

P/N 99922205787
REVISED 03/03/23

Blower Components **3**
Componentes do soprador

Accessories **4**
Accesorios

Labels **4**
Etiquetas

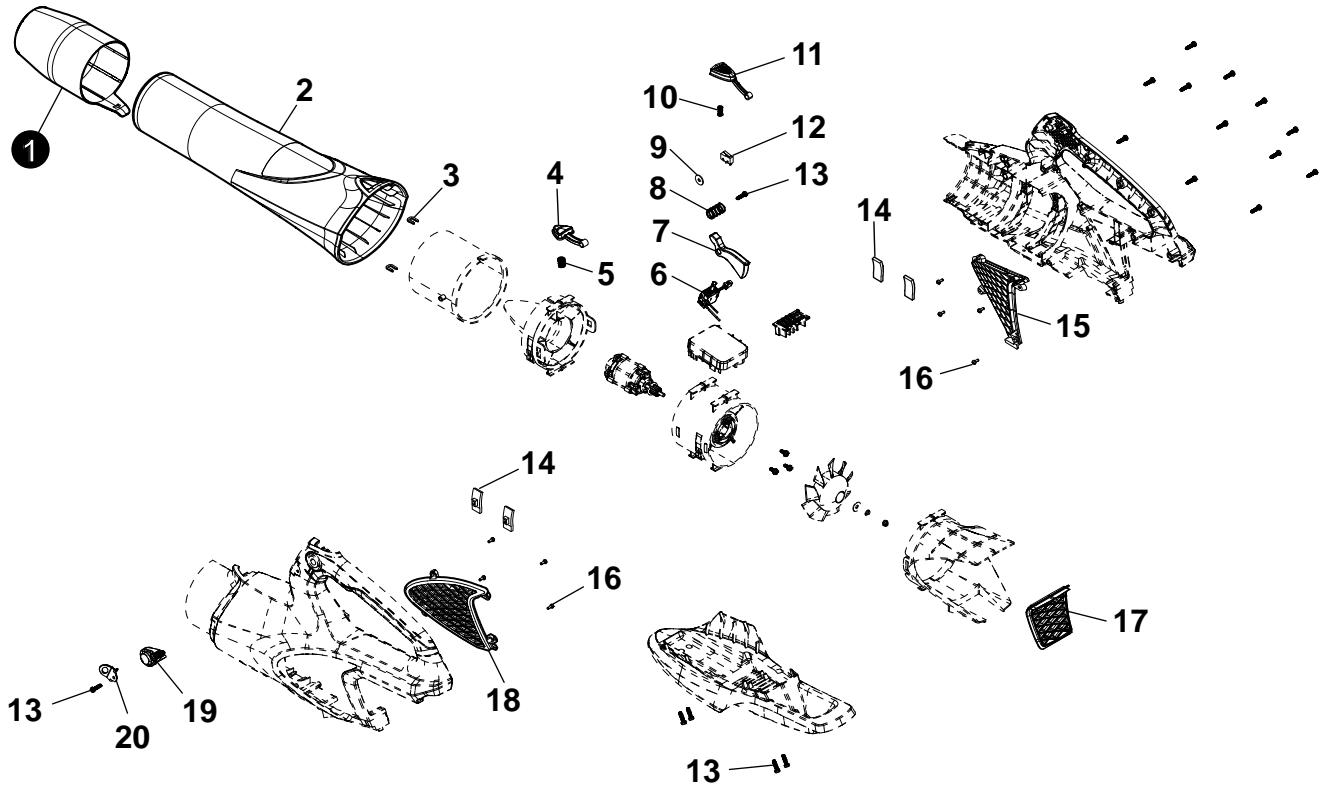

NO.	PART NUMBER	QTY.	DESCRIPTION	NOM DE LA PIÈCE
1	YH467000740	1	BLOWER TIP	POINTE DE SOUFFLERIE
2	YH467000720	1	BLOW PIPE	CANNE À SOUFFLER
3	YH452000790	2	RETAINER	DISPOSITIF DE RETENUE
4	YH470000970	1	BUTTON, RELEASE	BOUTON, DÉVERROUILLAGE
5	YH476000210	1	SPRING, COMPRESSION	RESSORT, COMPRESSION
6	YH321000220	1	SWITCH, SPEED-CONTROL	INTERRUPTEUR, CONTRÔLE DE VITESSE
7	YH470000960	1	TRIGGER	GÂCHETTE
8	YH476000200	1	SPRING, COMPRESSION	RESSORT, COMPRESSION
9	YH451000450	1	WASHER	RONDELLE
10	YH476000190	1	SPRING	RESSORT
11	YH470000950	1	BUTTON, TURBO	BOUTON, TURBO
12	YH321000230	1	SWITCH, MICRO	INTERRUPTEUR, MICRO
13	YH415000830	6	SCREW	VIS
14	YH468001720	4	INSULATOR, MOTOR	ISOLATEUR, MOTEUR
15	YH479002380	1	VENT, RIGHT	ÉVENT, DROIT
16	YH415000840	8	SCREW	VIS
17	YH479002370	1	VENT, REAR	ÉVENT, ARRIÈRE
18	YH479002360	1	VENT, LEFT	ÉVENT, GAUCHE
19	YH470000940	1	KNOB, CRUISE CONTROL	BOUTON, RÉGULATEUR DE VITESSE
20	YH452000780	1	HOOK, STRAP	CROCHET, SANGLE

NO.	PART NUMBER	QTY.	DESCRIPTION	NOM DE LA PIÈCE
1	LC-56V2AAB	1	CHARGER, BATTERY STANDARD 56V	CHARGEUR DE BATTERIE STANDARD 56V
2	LC-56V4AAB	1	CHARGER, BATTERY RAPID 56V	CHARGEUR DE BATTERIE RAPIDE 56V
3	LBP-56V125A	1	BATTERY, 56V LITHIUM-ION - 2.5Ah	BATTERIE, LITHIUM-ION 56V - 2.5Ah
4	LBP-56V250A	1	BATTERY, 56V LITHIUM-ION - 5.0Ah	BATTERIE, LITHIUM-ION 56V - 5.0Ah
5	99944100030	1	STRAP, SHOULDER	BRETELLES

Labels
Étiquettes



NO.	PART NUMBER	QTY.	DESCRIPTION	NOM DE LA PIÈCE
1	YH653001300	1	LABEL,WARNING	ÉTIQUETTE,AVERTISSEMENT
2	YH653001310	1	LABEL	ÉTIQUETER
3	YH653001320	1	LABEL ON TUBE	ÉTIQUETTE SUR LE TUBE