

HR 70/110/120/140 c-9

HYUNDAI Compaction Rollers

MOVING YOU FURTHER

HYUNDAI HEAVY INDUSTRIES



*Photo may include optional equipment.

 **HYUNDAI**
HEAVY INDUSTRIES

MOVING YOU FURTHER



HR 70/110/120/140 c-9

HYUNDAI Compaction Rollers



Machine Walk-Around

Front chassis and drum

Front and rear scrapers remove material in case humid or cohesive soils are compacted.

As an optional accessory, a pad foot segment kit can be attached to the smooth drum and the drum unit itself can be easily dismantled without lifting gear.

Furthermore, the front frame and the drum provide additional static load.

HA control

Perfect adaptation to different types of soil.

A continuous tractive force adjustment automatically ensures maximum traction at the axle and the drum at all times.

Vibration

2-stage vibration system with a high compaction capacity. 2 frequencies and amplitudes for surface and deep compaction can be selected. Large exterior bearings greased in an oil bath ensure long inspection intervals.

Safety

Ideal circumferential visibility, even while going backwards, thanks to the inclined engine hood and a compact design.

The ROPS panoramic cabin is equipped with individually adjustable operating elements.

Engine

Water-cooled Diesel engines with large fuel tanks, high durability and low fuel consumption. A minimized noise level is attained by means of special engine bearings.



Improved workability

Drum: Vibration system

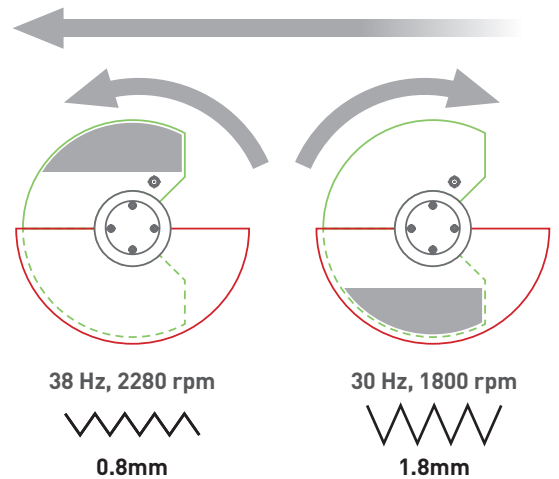
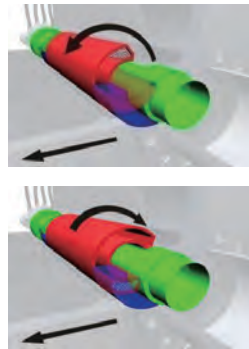
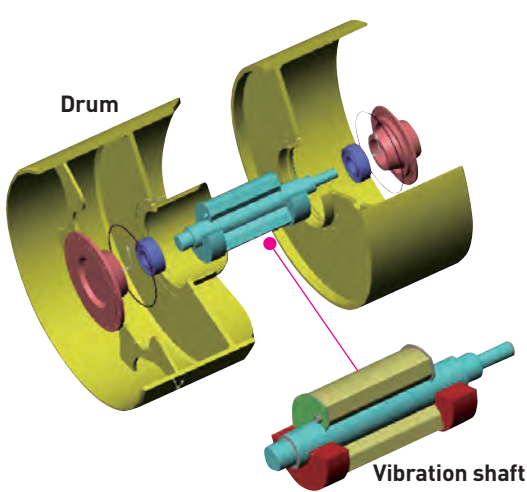

The HYUNDAI vibration system consists of an exciter shaft with a rigid welded, off-center weight. In addition, there is a metallic housing containing a flexible mass which is brought into an off-center position by means of centrifugal force. The flexible mass consists of steel balls \varnothing 3mm (roller bearings) – inserted with graphite for dry lubrication.

Changing the sense of rotation causes the position of center of gravity of the flexible mass to shift. Depending on the sense of rotation of the vibration shaft, the steel ball mass is either added to or subtracted from the rigid eccentric mass via the centrifugal force. This means that a sense of rotation adds an even greater eccentricity to the existing unbalanced mass.

High amplitude (for deep compaction)

By confronting it with the flexible mass, the opposite sense of rotation partly neutralizes the unbalanced mass created by the rigid eccentric mass.

Low amplitude (for surface compaction)

Depending on the rotational speed, different centrifugal forces can be attained. The entire kinetic force is composed of the vibrating mass of the drum and its rigidly attached components.

Thus, the compaction capacity of the machine is established.

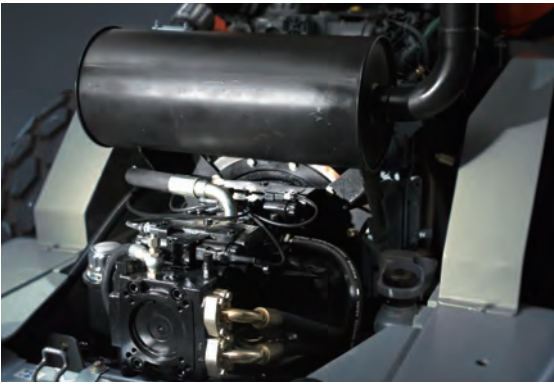

Engines

Machine		HR70C-9	HR110C-9	HR120C-9	HR140C-9
Tier 2 Engine	Model	Perkins 1104C-44	Deutz BF 4M 2012	Deutz BF 4M 2012 C	Deutz BF 4M 2012 C
	Output	62 Kw	95 Kw / 127 HP	95 Kw / 127 HP	100 Kw / 134 HP
Tier 3 Engine	Model	Perkins 1104D-44T	Deutz TCD 2012 L042V	Deutz TCD 2012 L042V	Deutz TCD 2012 L042V
	Output	62 Kw	96 Kw / 129 HP	96 Kw / 129 HP	103 Kw / 138 HP

Rear axle & Articulated pendulum joint

ECO Mode Vibration drive

ECO speed enables the driver to reduce the rotational speed of the Diesel engine to the ideal engine torque and the pump for the hydrostatic drive of the vibration unit establishes the required rotational speed of the exciter shaft by adjusting the volumetric current.

No-Spin-Axle

Part of the standard equipment of all Hyundai compaction rollers. A permanent differential lock serves to attain optimal traction. The differential lock unlatches automatically whenever different wheel speeds are the result of frequent turns and winding terrain.

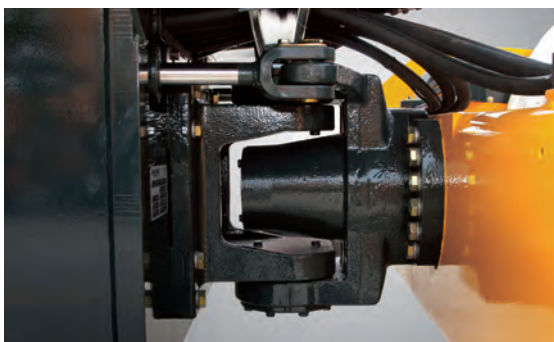

Articulated pendulum joint

The front and the rear end run in a single track.

The articulated pendulum joint requires little maintenance, thanks to the Teflon® bearing seats.

No lubrication points at the machines. The articulated pendulum is identical for all machines with operating weights ranging from 7 to 14 tons.



Door to be opened in the direction of motion bended window panes which serve to avoid "pumping" of the windows during operation with vibration.

Preference

Operator Comfort



A spacious cabin with excellent circumferential visibility and a low construction height. Individually adjustable driver's seat. Thanks to the use of special cabin bearings, vibrations are damped. Specifically shaped screens serve to reduce the noise level.



Sun screen

Roller style sun screens on the front window allow the operator to reduce glare and improve visibility.

Console - Joystick

- 1 Engine idle speed
- 2 Half throttle 1200 rpm
- 3 Full throttle 2400 rpm
- 4 Vibration on /off
- 5 ECO Speed, without this optional feature, no vibration possible at reduced Diesel engine speed
- 6 Overmodulation hydraulic motor, rear (accelerating the hydraulic motor of the drum to the max. rotational speed, e.g. reverse motion on slopes)
- 7 Amplitude low / high / off
- 8 Overmodulation hydraulic motor, front (accelerating the hydraulic motor of the axle to the max. rotational speed, e.g. forward motion on slopes)





Easy Maintenance

Easy access

All maintenance components and aggregates are easily accessible, thanks to the wide opening of the engine hood.

The maintenance-free articulated joint and the low-maintenance vibration unit warrant a long service life and reduce maintenance expenditures.

Easy air filter replacements



Adjustable scrapers



Easy accessible battery



Technical Specifications

WEIGHT	UNIT	HR70C-9	HR110C-9	HR120C-9	HR140C-9
Operating weight CECE	kg	7,100	11,200	12,000	13,900
Axle load, front	kg	3,800	6,100	6,900	8,000
Axle load, rear	kg	3,300	5,100	5,100	5,900

COMPACTION PERFORMANCE

Linear drum load	kg/cm	22.40	29.00	32.80	38.00
Amplitude high/low	mm	1.8 / 0.8	1.8 / 0.8	1.8 / 0.6	1.9 / 0.7
Frequency at high/low Amplitude	HZ	30 / 40	30 / 38	30 / 40	30 / 40
Centrifugal force at high/low Ampl.	kN	120 / 90	220 / 150	240 / 140	280 / 180

DRUM

Drum width	mm	1,700	2,100	2,100	2,100
Drum diameter	mm	1,250	1,500	1,500	1,500
Drum thickness	mm	20	25	30	30

DRIVE / TRANSMISSION

Speed range	km/h	0-10	0-12.5	0-12.5	0-12.5
Angular movement	-	±12	±12	±12	±12
Gradeability w/w/o vibration	%	45 / 50	43 / 48	45 / 48	40 / 45
Tires	-	16.9-24	23.1 - 26	23.1-26	23.1-26

ENGINE

Machine		HR70C-9	HR110C-9	HR120C-9	HR140C-9
Tier 2 Engine	Model	Perkins 1104C-44	Deutz BF 4M 2012	Deutz BF 4M 2012 C	Deutz BF 4M 2012 C
	Output	62 Kw	95 Kw / 127 HP	95 Kw / 127 HP	100 Kw / 134 HP
Tier 3 Engine	Model	Perkins 1104D-44T	Deutz TCD 2012 L042V	Deutz TCD 2012 L042V	Deutz TCD 2012 L042V
	Output	62 Kw	96 Kw / 129 HP	96 Kw / 129 HP	103 Kw / 138 HP

TANK CAPACITIES

Fuel capacity	l	167	300	300	300
Hydraulic oil capacity	l	68	106	106	106

DIMENSION

A Distance between axles	mm	2,720	3,195	3,195	3,195
B Width	mm	1,850	2,270	2,270	2,270
D Road clearance	mm	375	490	490	490
H Height	mm	2,723	2,920	2,920	2,920
H ₁ Drum diameter	mm	1,250	1,500	1,500	1,500
L Length	mm	5,032	5,757	5,757	5,757
R Inside turning radius	mm	3,900	4,860	4,860	4,860
R ₁ Outside turning radius	mm	5,600	7,015	7,015	7,015
W Width between tires	mm	1,700	2,090	2,090	2,090
W ₁ Drum width	mm	1,700	2,100	2,100	2,100
α Angle of steering lock	mm	±30°	±30°	±30°	±30°

STANDARD EQUIPMENT

- Low-maintenance centre-pivot steering
- Low-maintenance vibratory system with 2 amplitudes and frequencies
- No-spin rear axle
- Four-stage hydrostatic drive and traction control at the drum (not for HR70C-9)
- Both drives equipped with spring-loaded brake
- Battery main switch
- Reverse gear alarm
- Adjustable driver's seat with armrest
- Adjustable steering column (not for canopy type)
- Radio
- Emergency switch
- 4 working headlights
- Adjustable scraper
- Hot water heating with fresh-air fan (only for cabin type)

OPTIONAL EQUIPMENT

- Canopy with ROPS roll bar
- ROPS-Cabin with tinted glass
- Air conditioning (not for canopy type)
- Padfoot shell kit (3-part) for modification of a smooth drum
- Spring steel scraper blade (for smooth drum only)
- Vulcolan scraper blade (for smooth drum only)
- Cyclone dust separator
- Rotating light
- Special color
- Hydraulic fluid (environment-friendly)
- Compaction measurement (digital display)
- Compaction measurement with documentation
- Preparation for compaction measurement
- Turnable driver's seat
- Fuel-efficient ECO-Speed option (not for HR70C-9)

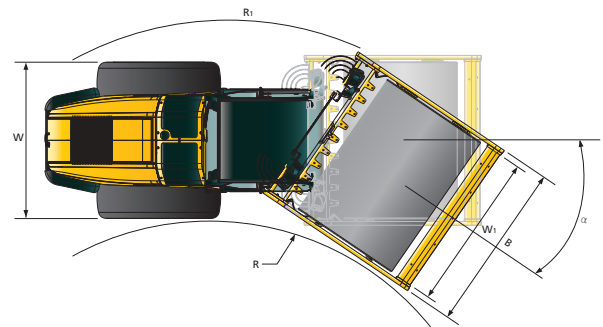
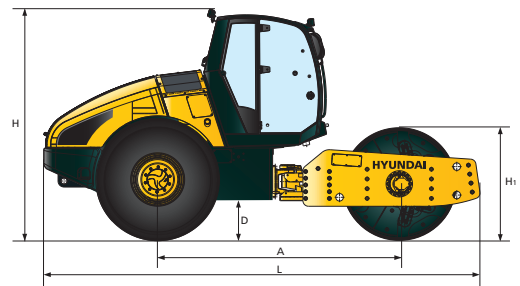

PLEASE CONTACT

HYUNDAI | CONSTRUCTION EQUIPMENT
HEAVY INDUSTRIES

Head Office
1000 BANGEOJINSUNHWAN-DORO, DONG-GU, ULSAN, 682-792, KOREA
TEL:(82)52-202-7722, 9807 FAX:(82)52-202-7720

