

greenworks

25052

EN	REEL MOWER	OPERATOR MANUAL
FR	TONDEUSE À ROULEAU	MANUEL D'OPÉRATEUR
ES	CORTADORA DE PASTO DE RODILLO	MANUAL DEL OPERADOR

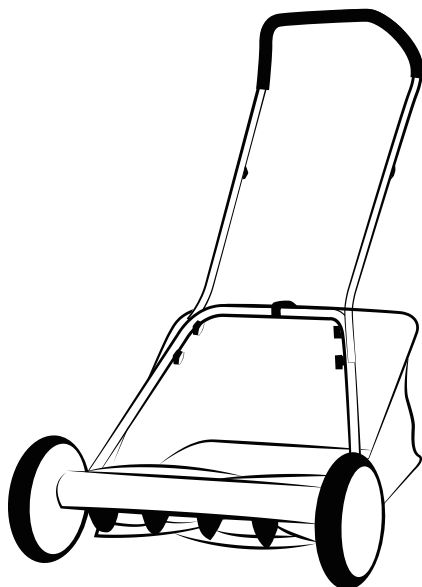

RMQ701

www.greenworkstools.com

1	Description.....	2	10	Operation.....	4
1.1	Overview.....	2	10.1	Adjust the cutting height.....	4
1.2	Packing list.....	2	10.2	Adjust the mower blade.....	5
2	General safety instructions.....	2	10.3	Check the adjustment.....	5
3	Symbols on the product.....	2	10.4	Operation tips.....	5
4	Risk levels.....	2	11	Maintenance.....	5
5	Proposition 65.....	3	11.1	Sharpen the cutting blades.....	5
6	Unpack the machine.....	3	11.2	Maintenance tip.....	6
7	Install the handle.....	3	12	Clean and Storage.....	6
8	Attach the handle to the mower base.....	3	13	Troubleshooting.....	6
9	Install the rear bag.....	3	14	Technical data.....	6
			15	Limited warranty.....	6
			16	Replacement parts.....	7

1 DESCRIPTION

1.1 OVERVIEW

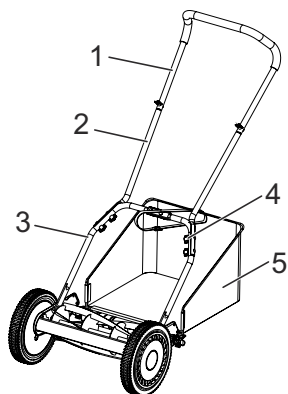

- | | |
|-----------------|-----------------|
| 1 Upper handle | 4 Carriage bolt |
| 2 Middle handle | 5 Rear bag |
| 3 Lower handle | |

1.2 PACKING LIST

- | | |
|-----------------|---------------------|
| 1 Upper handle | 5 Carriage bolt (8) |
| 2 Middle handle | 6 Reel mower body |
| 3 Lower handle | 7 Rear bag |
| 4 Knob (8) | 8 Manual |

2 GENERAL SAFETY INSTRUCTIONS

▲ WARNING

This unit can be dangerous! Careless or improper use can cause serious injury.

- Never place hands, fingers or feet inside the reel. Although a motor does not power this mower, when the wheels turn the reel spins and can cut.
- Never mow when grass is wet as it can be slippery.
- Do not use the reel mower while barefoot or while wearing sandals.
- Walk behind, never run, while using reel mower. Always make sure of your footing when using this reel mower.
- Never intentionally strike or hit trees, fences, etc. This can cause injuries or severely damage the reel mower mechanisms.
- Make sure your reel mower is in a safe operating condition. Do not attempt to operate this reel mower if damaged.
- Contact customer service or have the reel mower repaired by a qualified repair service provider before using.

3 SYMBOLS ON THE PRODUCT

Some of the following symbols may be used on this product. Please study them and learn their meaning. Proper interpretation of these symbols will allow you to operate the product better and safer.

Symbol	Explanation
	Read and understand all instructions before operating the product, and follow all warnings and safety instructions.
	Wear eye protection.
	Thrown objects can ricochet and result in personal injury or property damage. Wear protective clothing and boots.
	Keep all bystanders at least 15m away.
	Risk of cut. Keep hands and feet away from tines and cutting area.

4 RISK LEVELS

The following signal words and meanings are intended to explain the levels of risk associated with this product.

SYMBOL	SIGNAL	MEANING
	DANGER	Indicates an imminently hazardous situation, which, if not avoided, will result in death or serious injury.
	WARNING	Indicates a potentially hazardous situation, which, if not avoided, could result in death or serious injury.
	CAUTION	Indicates a potentially hazardous situation, which, if not avoided, may result in minor or moderate injury.
	CAUTION	(Without Safety Alert Symbol) Indicates a situation that may result in property damage.

5 PROPOSITION 65

▲ WARNING

This product contains a chemical known to the state of California to cause cancer, birth defects or other reproductive harm. Some dust created by power sanding, sawing, grinding, drilling, and other construction activities contains chemicals known to cause cancer, birth defects or other reproductive harm. Some examples of these chemicals are:

- Lead from lead-based paints;
- Crystalline silica from bricks and cement and other masonry products;
- Arsenic and chromium from chemically treated lumber.

Your risk of exposure to these chemicals varies depending on how often you do this type of work. To reduce your exposure to these chemicals, work in a well-ventilated area, and work with approved safety equipment, such as dust masks that are specially designed to filter out microscopic particles.

Save these instructions.

6 UNPACK THE MACHINE

▲ WARNING

Make sure that you correctly assemble the machine before use.

▲ WARNING

- If parts of the machine are damaged, do not use the machine.
- If you do not have all the parts, do not operate the machine.
- If parts are damaged or missing, contact the service center.

1. Open the package.
2. Read the documentation provided in the box.
3. Remove all the unassembled parts from the box.
4. Remove the machine from the box.
5. Discard the box and packing material in compliance with local regulations.

7 INSTALL THE HANDLE

i NOTE

Do not completely tighten knobs until assembly is complete.

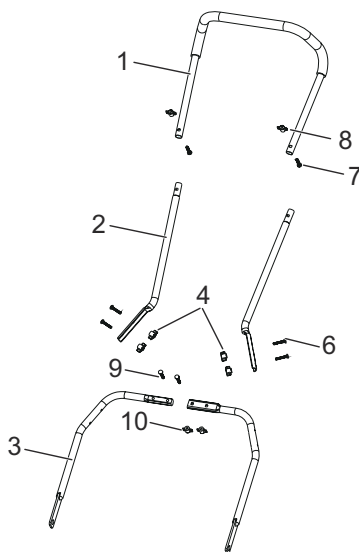

1. Lay handles flat on ground.
2. Insert the middle handles (2) into the left and right side of the upper handles (1), and secure with the carriage bolts (7) and knobs (8).
3. Attach the right lower handle to the left lower handle with the carriage bolts (9) and knobs (10).
4. Insert the lower handles (3) into the left and right side of the middle handles (2), and secure with the carriage bolts (6) and knobs (4).
5. Tighten all the knobs on the joints of the handle assembly.

8 ATTACH THE HANDLE TO THE MOWER BASE

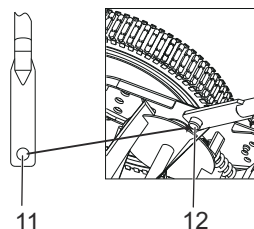

1. Align holes (11) at the lower end of each handle arm with posts (12) extending from the mower base side plates.
2. Slide lower ends of handle arms onto posts.

9 INSTALL THE REAR BAG

1. Take out all components in the packing.

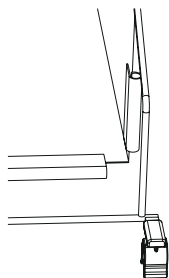

- 2. Push the bar frame into the grass box tube.
- 3. Snap the side fastening lugs on the grass box over the bar frame.

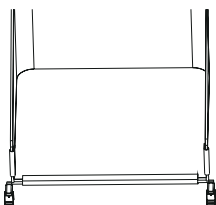

- 4. Snap the bottom fastening lug on the grass box over the bar frame.



- 5. Place the hooks on the rear bag onto the roller shaft. Secured the bag to the lower handle with the belt.

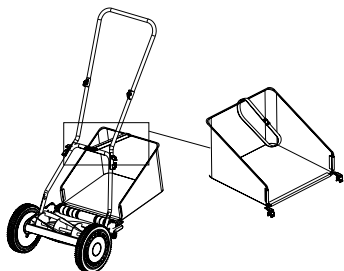

- 6. Adjust strap for proper height so the bag does not rub the ground while mowing or transporting.

10 OPERATION

Align cutting path indication arrow with previously cut path.

i NOTE
The width of the machine actual cut is indicated below. Do not use wheels as a reference point for grass cut line.

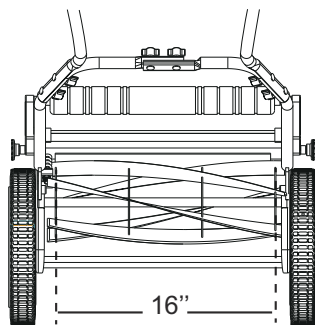

10.1 ADJUST THE CUTTING HEIGHT

The machine can be set to different cutting heights.

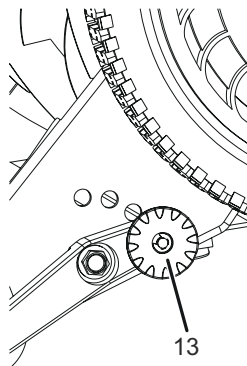

- 1. Pull the height adjustment knob (13) out and rotate to desired setting.

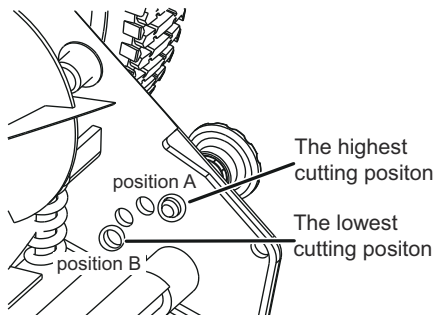

2. Move the height adjustment knob to a higher position to increase the cutting height.
3. Move the height adjustment knob to a lower position to decrease the cutting height.

10.2 ADJUST THE MOWER BLADE

▲ WARNING

Blades are extremely sharp. To avoid injury, do not touch blades when making adjustments.

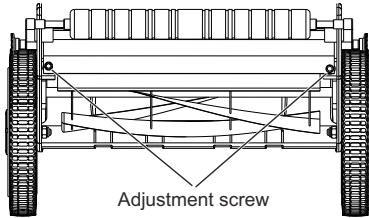

1. The misalignment of blades can cause an uneven cut or difficulty pushing the mower.
2. Each end of the cutting bar is adjusted separately.
3. Turn the adjustment screw clockwise to move the cutting bar closer to the blades.
4. Turn the adjustment screw counterclockwise to move the cutting bar away from the blades.
5. When the space equals the thickness of paper (0.12 mm), insert a piece of paper between the blades and the cutter bar, and quickly turn the wheel by hand.

▲ CAUTION

It is a sensitive procedure to adjust the screws for blade adjustments. A sixteenth of a turn is a major adjustment. Before tightening one adjustment screw, loosen the opposite screw an equal amount.

10.3 CHECK THE ADJUSTMENT

1. Turn the machine upside down.
2. Insert a piece of paper between cutter bar and reel blades, and slowly turn wheel by hand.

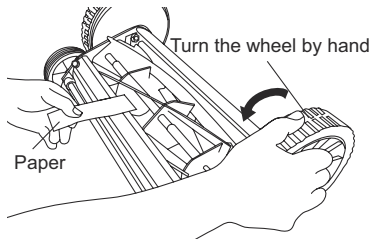

3. All blades must slice the paper evenly, along the entire length of the cutter bar while the reel turns smoothly.

4. If the machine has an intermittent cut, adjust the blades to the appropriate side to cut correctly.

▲ WARNING

Do not overtighten adjustment screw as this could damage cutter bar. Both screws must be tight on final adjustment.

10.4 OPERATION TIPS

▲ WARNING

Make sure that the lawn is clear of stones, sticks, wire or other objects which could damage mower or user. The operation of mower can result in foreign objects being thrown into the eyes, which can damage your eyes severely. Always wear safety glasses while operating the mower.

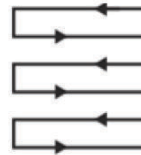

1. Do not cut wet grass because it tends to stick to the underbody of the product, preventing the proper discharge of grass clippings and it could also cause you to slip and fall.
2. Never cut off more than one-third of the total length of the grass for a healthy lawn. In the autumn, lawns should only be cut as long as there is growth.
3. Slowly push the product forward.
4. Mow in slightly overlapping rows. The most effective pattern for mowing lawns is straight lines. This will keep the rows even and ensures that all the lawn is cut without missing any spots.
5. Circle around flower beds. When reaching a flower bed in the middle of the lawn, cut a row or two around the circumference of the bed.
6. Pay special attention when changing direction.

11 MAINTENANCE

- Minimum care is required to ensure smooth operation of your mower.
- To avoid damage to mower or cutting blades, keep area to be mowed free from debris.
- For best results, regularly apply lubricant to mower's cutting surfaces, cutting reel axle shaft and wheels.

11.1 SHARPEN THE CUTTING BLADES

1. Spread a thin layer of lapping compound on the front edge of the reel blades.
2. Adjust the cutter bar so that the blade has light but firm contact across the full width of the cutter bar.

3. Turn the reel blades until the front edge of the cutter bar blade is polished.

▲ CAUTION

Do not overtighten the adjusting screws, as this could damage the cutter bar. Tighten both screws during final adjustment.

▲ WARNING

Clean any grinding compound or debris from the cutter bar blade, reel blade, pinions and pawls.

i NOTE

Use industrial or valve lapping compound between 100 and 240 grit. Lubricate the axle and pinion with a light file of wheel bearing grease.

11.2 MAINTENANCE TIP

The machine is relatively low maintenance. For consistent cutting follow the below instructions:

- Always keep the cutting bar properly adjusted. Refer to the instruction manual for further directions.
- Regularly clean and lube cutting edges with light spray oil.

▲ CAUTION

The machine has a difficult time with tall weeds such as dandelions which most times will cause the weeds to bend instead of cut. Cut often to prevent long lengths.

12 CLEAN AND STORAGE

- Clean the exterior of the machine thoroughly using a soft brush and cloth before storing. Do not use water, solvents or polishes.
- Turn the mower on its side to clean the blade area.
- Store the mower in a dry place. Do not place other objects on top of the mower during storage.

▲ WARNING

Do not place hands in the mower near blades. If grass cuttings are compacted in the blade area, remove using a wood or plastic cleaning tool appropriate for the cleaning of the blades.

13 TROUBLESHOOTING

Problem	Possible cause	Solution
Unsatisfying cutting result.	Blade clearance is too wide.	Adjusting the blade clearance, refer to maintenance section.
Machine is too noisy and difficult to operate.	Blade clearance is too narrow.	

* If you cannot find the solution to these problems, please go to the service center.

14 TECHNICAL DATA

Rotor	5 Helical blades
Cutting path	16" (40 cm)
Height adjustments	0.98 - 1.97" (2.5 - 5.0 cm)
Weight	24.7 lbs. (11.2 kg)

15 LIMITED WARRANTY



Greenworks hereby warranties this product, to the original purchaser with proof of purchase, for a period of three (3) years against defects in materials, parts or workmanship. Greenworks, at its own discretion, will repair or replace any and all parts found to be defective, through normal use, free of charge to the customer. This warranty is valid only for units which have been used for personal use that have not been hired or rented for industrial/commercial use, and that have been maintained in accordance with the instructions in the owners' manual supplied with the product from new.

ITEMS NOT COVERED BY WARRANTY:

1. Any part that has become inoperative due to misuse, commercial use, abuse, neglect, accident, improper maintenance, or alteration; or
2. The unit, if it has not been operated and/or maintained in accordance with the owner's manual; or
3. Normal wear, except as noted below;
4. Routine maintenance items such as lubricants, blade sharpening;
5. Normal deterioration of the exterior finish due to use or exposure.

HELPLINE:

Warranty service is available by calling our toll-free helpline at 1-888-909-6757.

TRANSPORTATION CHARGES:

Transportation charges for the movement of any power equipment unit or attachment are the responsibility of the purchaser. It is the purchaser's responsibility to pay transportation charges for any part submitted for replacement

under this warranty unless such return is requested in writing by Greenworks.

USA address:

Greenworks Tools
P.O. Box 1238

Mooresville, NC 28115

Canadian address:

Greenworks Tools Canada, Inc.
P.O. Box 93095, Newmarket,
Ontario

L3Y 8K3

16 REPLACEMENT PARTS

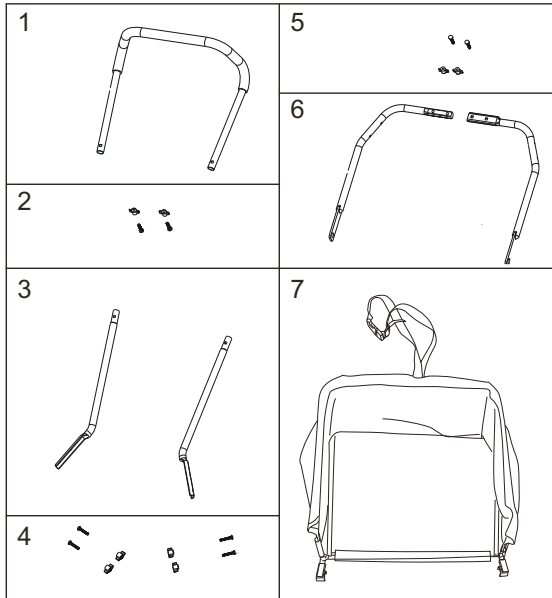

No.	Part No.	Qty	Description	No.	Part No.	Qty	Description
1	R0202138-00	1	Upper handle	5	R0202141-00	1	Lower handle knob/bolt
2	R0202141-00	1	Upper handle knob/bolt	6	R0202140-00	1	Lower handle
3	R0202139-00	1	Middle handle	7	R0202142-00	1	Bag
4	R0202141-00	1	Middle handle knob/bolt				

R0202141-00 is listed more than once (part 2/4/5)