

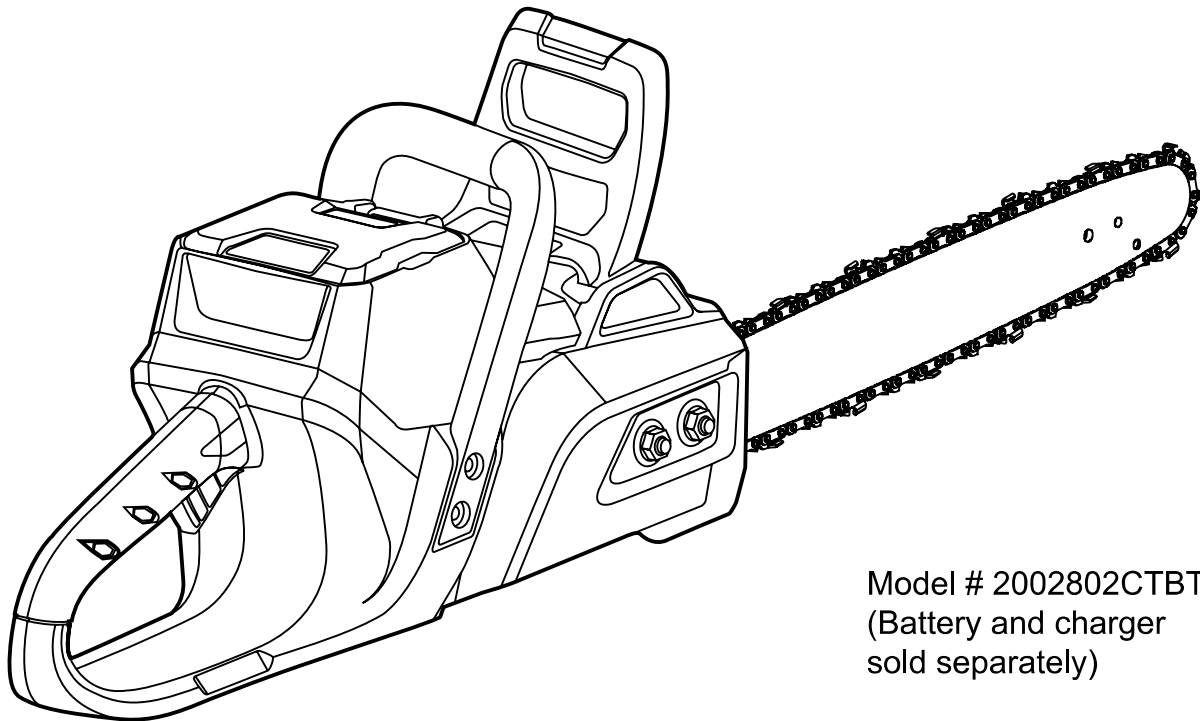

60V 16" BRUSHLESS CHAINSAW
2002802CTBT/2002802CT



Model # 2002802CTBT:
(Battery and charger
sold separately)



218549

Owner's Manual

TOLL-FREE HELPLINE: 1-855-345-3934

www.greenworkstools.com

Read all safety rules and instructions carefully before operating this tool.

CONTENTS

Contents	2
Product Specifications	2
Important Safety Instructions.....	3
Symbols	9
Know Your Chainsaw	11
Assembly	12
Operation.....	16
Battery & Charger Maintenance	26
Maintenance.....	28
Environmentally Safe Battery Disposal.....	37
Troubleshooting.....	38
Limited Warranty.....	39
Exploded View	40
Part List	41

PRODUCT SPECIFICATIONS

60V CORDLESS CHAINSAW

Type	Cordless
Motor	Brushless
Voltage.....	60V Lithium-Ion
Bar Length	16" (406 mm)
Chain Pitch	3/8" LP (9.5 mm)
Chain Gauge.....	.050" (1.27 mm)
Chain Type	91PJ056X
Drive Links.....	56 DL
Guide Bar Type	160SDEA041
Oil Tank Capacity.....	6.12 oz (170 ml)
Bucking Spikes.....	Metal
Unit Weight (Without Battery)	9.46 lbs (4.3 kg)



IMPORTANT SAFETY INSTRUCTIONS

⚠ W A R N I N G

Read and understand all instructions before using this product. Failure to follow all instructions listed below may result in electric shock, fire, and/or serious personal injury.

WORK AREA SAFETY

- **Keep work area clean and well lit.** Cluttered or dark areas invite accidents.
- **Do not operate chainsaw in explosive atmospheres, such as in the presence of flammable liquids, gases, or dust.** Chainsaws create sparks which may ignite the dust or fumes.
- **Keep all children, bystanders, visitors, and animals out of the work area while starting or cutting with the chainsaw.** Distractions can cause you to lose control.

ELECTRICAL SAFETY

- **Avoid body contact with earthed or grounded surfaces such as pipes, radiators, ranges and refrigerators.** There is an increased risk of electric shock if your body is earthed or grounded.
- **Do not expose the chainsaw to rain or wet locations.** Water entering a chainsaw will increase the risk of electric shock.
- **If operating a power tool in a damp location is unavoidable, use a residual current device protected supply.** Use of an RCD reduces the risk of electric shock.
- **A battery-operated tool with integral batteries or a separate battery pack must be recharged only with the specified charger for the battery.** A charger that may be suitable for one type of battery may create a risk of fire when used with another battery.

PERSONAL SAFETY

- **Stay alert, watch what you are doing and use common sense when operating a chainsaw. Do not use a chainsaw while you are tired or under the influence of drugs, alcohol or medication.** A moment of inattention while operating chainsaws may result in serious personal injury.
- **Use safety equipment. Always wear eye protection.** Safety equipment such as dust mask, non-skid safety shoes, hard hat, or hearing protection used for appropriate conditions will reduce personal injuries.
- **Avoid accidental starting. Ensure the switch is in the off-position before plugging in.** Carrying power tools with your finger on the switch or plugging in power tools that have the switch on invites accidents.
- **Remove any adjusting key or wrench before turning the power tool on.** A wrench or a key left attached to a rotating part of the chainsaw may result in personal injury.
- **Do not overreach. Keep proper footing and balance at all times.** This enables better control of the chainsaw in unexpected situations.
- **Dress properly. Do not wear loose clothing or jewellery. Keep your hair, clothing and gloves away from moving parts.** Loose clothes, jewellery or long hair can be caught in moving parts.
- **If devices are provided for the connection of dust extraction and collection facilities, ensure these are connected and properly used.** Use of these devices can reduce dust-related hazards.

IMPORTANT SAFETY INSTRUCTIONS

POWER USE AND CARE

- **Do not force the chainsaw. Use the correct chainsaw for your application.** The correct chainsaw will do the job better and safer at the rate for which it was designed.
- **Do not use the chainsaw if the switch does not turn it on and off.** Any chainsaw that cannot be controlled with the switch is dangerous and must be repaired.
- **Disconnect the battery pack from the power tool before making any adjustments, changing accessories, or storing power tools.** Such preventive safety measures reduce the risk of starting the power tool accidentally.
- **Store idle chainsaws out of the reach of children and do not allow persons unfamiliar with the chainsaw or these instructions to operate the chainsaw.** Chainsaws are dangerous in the hands of untrained users.
- **Maintain chainsaws. Check for misalignment or binding of moving parts, breakage of parts and any other condition that may affect the chainsaw's operation.** If damaged, have the chainsaw repaired before use. Many accidents are caused by poorly maintained chainsaws.
- **Keep cutting tools sharp and clean.** Properly maintained cutting tools with sharp cutting edges are less likely to bind and are easier to control.
- **Use the chainsaw, accessories and tool bits etc. in accordance with these instructions, taking into account the working conditions and the work to be performed.** Use of the chainsaw for operations different from those intended could result in a hazardous situation.

BATTERY TOOL USE AND CARE

- **Ensure the switch is in the off position before inserting battery pack.** Inserting the battery pack into power tools that have the switch on invites accidents.
- **Recharge only with the charger specified by the manufacturer.** A charger that is suitable for one type of battery pack may create a risk of fire when used with another battery pack.
- **Use power tools only with specifically designated battery packs.** Use of any other battery packs may create a risk of injury and fire.
- **When battery pack is not in use, keep it away from other metal objects, like paper clips, coins, keys, nails, screws, or other small metal objects, that can make a connection from one terminal to another.** Shorting the battery terminals together may cause burns or a fire.
- **Under abusive conditions, liquid may be ejected from the battery; avoid contact. If contact accidentally occurs, flush with water.** If liquid contacts eyes, additionally seek medical help. Liquid ejected from the battery may cause irritation or burns.

SERVICE

- **Have your chainsaw serviced by a qualified repair person using only identical replacement parts.** This will ensure that the safety of the chainsaw is maintained.

IMPORTANT SAFETY INSTRUCTIONS

SPECIFIC SAFETY WARNINGS

- **Keep all parts of the body away from the saw chain when the chainsaw is operating. Before you start the chainsaw, make sure the saw chain is not contacting anything.** A moment of inattention while operating chainsaws may cause entanglement of your clothing or body with the saw chain.
- **Always hold the chainsaw with your right hand on the rear handle and your left hand on the front handle.** Holding the chainsaw with a reversed hand configuration increases the risk of personal injury and should never be done.
- **Hold the chainsaw by insulated gripping surfaces only, because the saw chain may contact hidden wiring.** Saw chains contacting a “live” wire may make exposed metal parts of the chainsaw “live” and could give the operator an electric shock.
- **Always use two hands when operating the chainsaw.** Contact of the guide-bar tip with any object should be avoided.
- **Tip contact may cause the guide bar to move suddenly upward and backward, which may cause serious injury.**
- **Wear safety glasses and hearing protection. Further protective equipment for the head, hands, legs, and feet is recommended.** Adequate protective clothing will reduce personal injury by flying debris or accidental contact with the saw chain.
- **Do not operate a chainsaw in a tree.** Operation of a chainsaw while up in a tree may result in personal injury.
- **Always keep proper footing and operate the chainsaw only when standing on fixed, secure and level surface.** Slippery or unstable surfaces such as ladders may cause a loss of balance or control of the chainsaw.
- **When cutting a limb that is under tension, be alert for spring back.** When the tension in the wood fibers is released, the spring loaded limb may strike the operator and/or throw the chainsaw out of control.
- **Use extreme caution when cutting brush and saplings.** The slender material may catch the saw chain and be whipped toward you or pull you off balance.
- **Carry the chainsaw by the front handle with the chainsaw switched off and away from your body. When transporting or storing the chainsaw always put on the scabbard.** Proper handling of the chainsaw will reduce the likelihood of accidental contact with the moving saw chain.
- **Follow instructions for lubricating, chain tensioning, and changing accessories.** Improperly tensioned or lubricated chain may either break or increase the chance for kickback.
- **Keep handles dry, clean, and free from oil and grease.** Greasy, oily handles are slippery which can cause loss of control.
- **Cut wood only. Do not use chainsaw for purposes not intended. For example: do not use chainsaw for cutting plastic, masonry, or non-wood building materials.** Use of the chainsaw for operations different than intended could result in a hazardous situation.

IMPORTANT SAFETY INSTRUCTIONS

⚠ W A R N I N G (PROPOSITION 65)

Some dust created by power sanding, sawing, grinding, drilling, and other construction activities contains chemicals known to cause cancer, birth defects or other reproductive harm. Some examples of these chemicals are:

- Lead from lead-based paints
- Crystalline silica from bricks and cement and other masonry products, and
- Arsenic and chromium from chemically treated lumber.

Your risk of exposure to these chemicals varies depending on how often you do this type of work. To reduce your exposure to these chemicals, work in a well-ventilated area, and work with approved safety equipment, such as dust masks that are specifically designed to filter out microscopic particles.

CHILD SAFETY

Tragic accidents can occur if the operator is not aware of the presence of children.

- Keep children out of the working area and under the watchful care of a responsible adult.
- Do not allow children under the age of 18 to operate this chainsaw. Children who are 18 years of age and older must read and understand the operating instructions and safety rules in this manual and must be trained and supervised by a parent.
- Stay alert, and turn the chainsaw off if a child or any other person enters the working area.
- Use extreme care when approaching blind corners, doorways, shrubs, trees, or other objects that may obscure your view of a child who may run into the path of the chainsaw.

SAVE THESE INSTRUCTIONS

IMPORTANT SAFETY INSTRUCTIONS

CAUSES AND OPERATOR PREVENTION OF KICKBACK

⚠ WARNING

Kickback may occur when the moving chain contacts an object at the upper portion of the tip of the guide bar or when the wood closes in and pinches the saw chain in the cut. Contact at the upper portion of the tip of the guide bar can cause the chain to dig into the object and stop the chain for an instant. The result is a lightning fast reverse reaction which kicks the guide bar up and back toward the operator. If the saw chain is pinched along the top of the guide bar, the guide bar can be driven rapidly back toward the operator. Either of these reactions can cause loss of saw control which can result in serious injury. Do not rely exclusively upon the safety devices built into the saw. As a chainsaw user, you should take several steps to keep your cutting jobs free from accident or injury.

Kickback is the result of tool misuse and/or incorrect operating procedures or conditions and can be avoided by taking proper precautions as given below:

1. Maintain a firm grip, with thumbs and fingers encircling the chainsaw handles, with both hands on the saw and position your body and arm to allow you to resist kickback forces. Kickback can be controlled by the operator, if proper precautions are taken. Do not let go of the chainsaw.

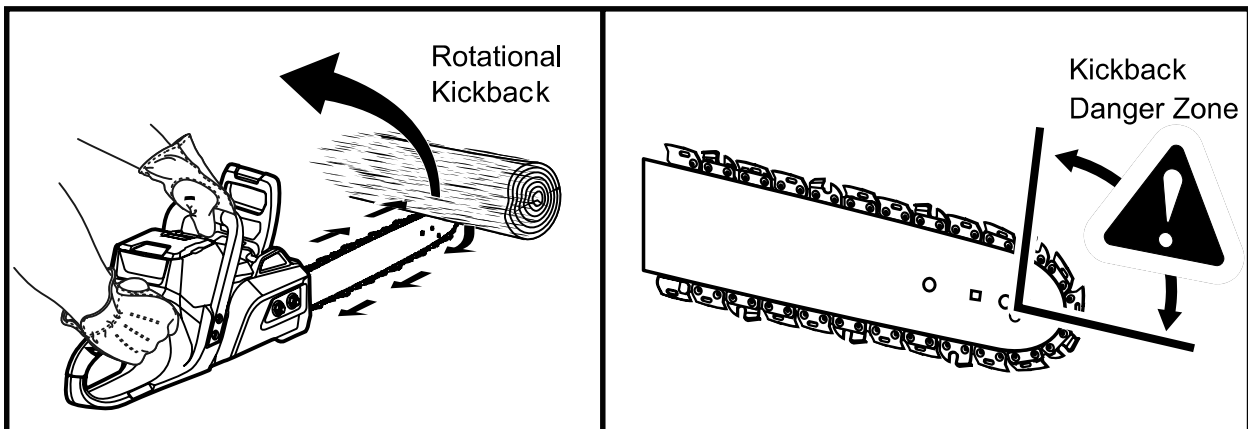

2. Do not overreach and do not cut above shoulder height. This helps prevent unintended tip contact and enables better control of the chainsaw in unexpected situations.

3. Only use replacement bars and chains specified by the manufacturer. Incorrect replacement bars and chains may cause chain breakage and/or kickback.

4. Follow the manufacturer's sharpening and maintenance instructions for the saw chain. Decreasing the depth gauge height can lead to increased kickback.

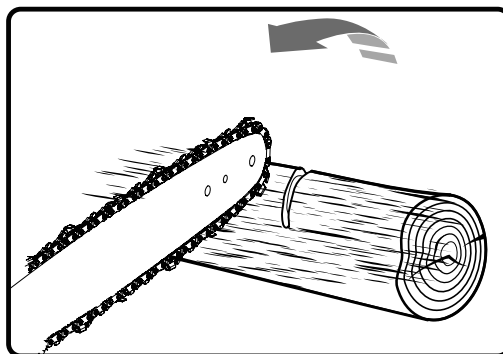

IMPORTANT SAFETY INSTRUCTIONS

Push and pull - This reaction force is always opposite to the direction the chain is moving where wood contact is made. Thus, the operator must be ready to control the **PULL** when cutting on the bottom edge of the bar, and **PUSH** when cutting along the top edge.

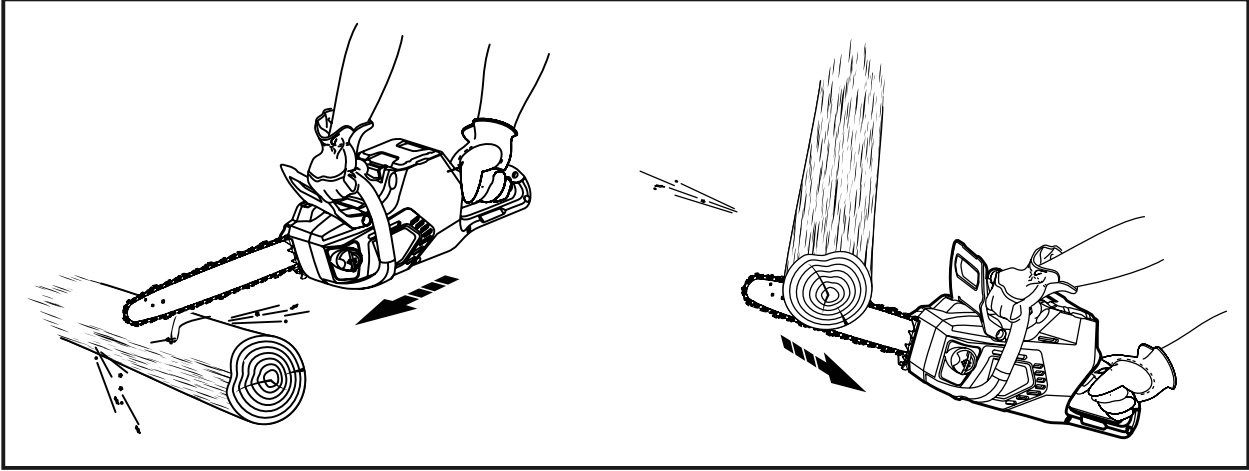

UNDERSTANDING YOUR CHAINSAW SAFETY DEVICES

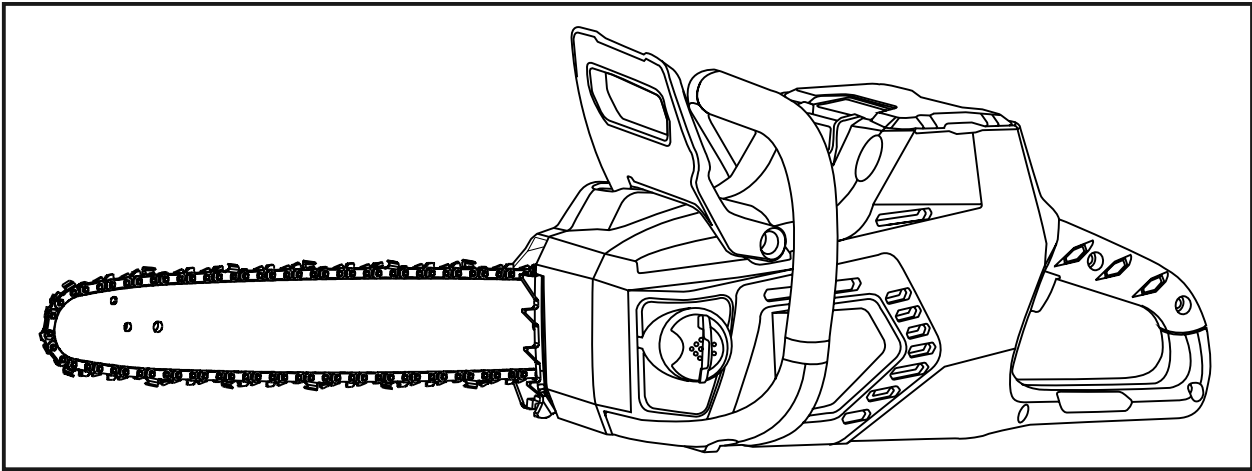















LOW-KICKBACK SAW CHAIN

The rakers (depth gauges) ahead of each cutter can minimize the force of a kickback reaction by preventing the cutters from digging in too deeply at the kickback zone. Only use replacement chain that is equivalent to original chain or has been certified as low kickback chain per ANSI B175.1. Low-kickback/skip tooth saw chain is a chain that has met the kickback performance requirements of ANSI B175.1 - 1991. When tested on the representative sample of chainsaws below 3.8 c.i.d. specified in ANSI B175.1 - 1991. As saw chains are sharpened during their useful life, they lose some of the low-kickback qualities and extra caution should be used.



SYMBOLS

Some of the following symbols may be used on this product. Please study them and learn their meaning. Proper interpretation of these symbols will allow you to operate the product better and safer.

SYMBOLS	DESIGNATION	EXPLANATION
V	Volts	Voltage
A	Amperes	Current
Hz	Hertz	Frequency (cycles per second)
W	Watts	Power
hrs	Hours	Time
n_0	No Load Speed	Rotational speed, at no load
/ min	Per Minute	Revolutions, strokes, surface speed, orbits etc., per minute.
	Direct Current	Type or a characteristic of current
	Lithium-ion Battery Recycling	Designates that this tool is in compliance with lithium-ion battery recycling program requirements.
	Safety Alert Symbol	Precautions that involve your safety.
	Read the Instruction Manual	To reduce the risk of injury, user must read and understand the Instruction manual before using this product.
	Eye Protection	Wear eye protection when operating this equipment.
	Wear Ear Protection	Wear ear protection when operating this equipment.
	Gloves	Wear non-slip, heavy-duty protective gloves when handling the chainsaw and the blade.
	Safety Footwear	Wear non-slip safety footwear when using this equipment.
	Kickback	DANGER! Beware of kickback.
	Operate With Two Hands	Hold and operate the saw properly with both hands.
	One Handed	Do not operate the saw using only one hand.
	Bar Nose Contact	Avoid bar nose contact.
	Keep Bystanders Away	Keep all bystanders at least 50' (15 m) away.
	Wet Conditions Alert	Do not expose to rain or use in damp locations.

SYMBOLS

The following signal words and meanings are intended to explain the levels of risk associated with this product.

SYMBOL	SIGNAL	MEANING
	DANGER	Indicates an imminently hazardous situation, which, if not avoided, will result in death or serious injury.
	WARNING	Indicates a potentially hazardous situation, which, if not avoided, could result in death or serious injury.
	CAUTION	Indicates a potentially hazardous situation, which, if not avoided, may result in minor or moderate injury.
	CAUTION	(Without Safety Alert Symbol) Indicates a situation that may result in property damage.

SERVICE

Servicing requires extreme care and knowledge and should be performed only by a qualified service technician. For service we suggest you return the product to your nearest **AUTHORIZED SERVICE CENTER** for repair. When servicing, use only identical replacement parts.

WARNING

- Do not use on wet ground.
 - Disconnect before cleaning or changing accessories.
-

WARNING

To avoid serious personal injury, do not attempt to use this product until you have read this Owner's Manual thoroughly and understand it completely. If you do not understand the warnings and instructions in this Owner's Manual, do not use this product. Call the Toll-free Helpline (1-855-345-3934) for assistance.

WARNING

 The operation of any power tool can result in foreign objects being thrown into your eyes, which can result in severe eye damage. Before operating a power tool, always wear safety goggles, safety glasses with side shields, or a full face shield when needed. We recommend a Wide Vision Safety Mask for use over eyeglasses or standard safety glasses with side shields. Always use eye protection that is marked to comply with ANSI Z87.1.

SAVE THESE INSTRUCTIONS

KNOW YOUR CHAINSAW

KNOW YOUR CHAINSAW

The safe use of this product requires an understanding of the information on the product and in this operator's manual as well as a knowledge of the project you are attempting. Before use of this product, familiarize yourself with all operating features and safety rules.

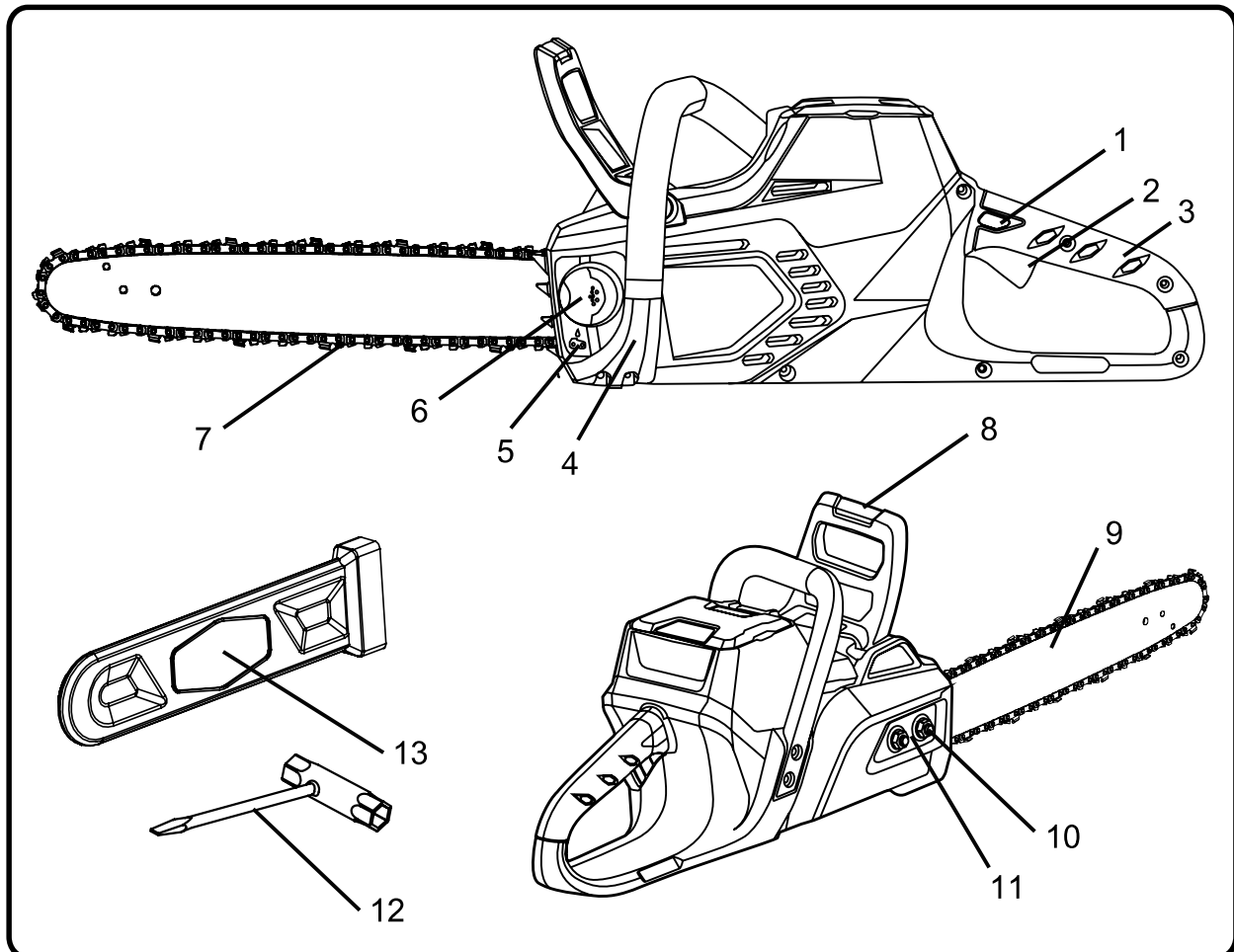

1. Safety Lock	8. Chain Brake
2. Trigger	9. Bar
3. Rear Handle	10. Bar Nuts
4. Front Handle	11. Chain Tensioner Screw
5. Quick View Oil Indicator	12. Wrench
6. Oil Cap	13. Scabbard
7. Low Kickback Chain	





ASSEMBLY

UNPACKING

This product has been shipped completely assembled.

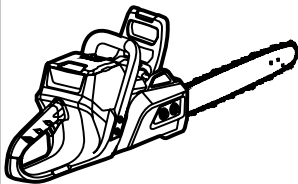
- Carefully remove the product and any accessories from the box. Make sure that all items listed in the package list section are included.
- Inspect the product carefully to make sure no breakage or damage occurred during shipping.
- Do not discard the packing material until you have carefully inspected and satisfactorily operated the product.
- If any parts are damaged or missing, please call 1-855-345-3934 for assistance.

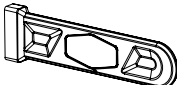
PACKING LIST

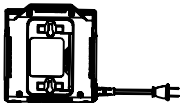
Part Name	Figure	2002802CTBT	2002802CT	Qty
Chainsaw		✓	✓	1
Wrench		✓	✓	1
Scabbard		✓	✓	1
Operator's Manual		✓	✓	1
Battery		✓	✓	1
Charger		✓	✓	1
		✓ <i>Included</i>		
		✓ <i>Not included</i>		

▲ WARNING

If any parts are damaged or missing, do not operate this product until the parts are replaced. Using a product with damaged or missing parts could result in serious personal injury.

ASSEMBLY

⚠ WARNING

Do not attempt to modify this product or create accessories not recommended for use with this product. Any such alteration or modification is misuse and could result in a hazardous condition leading to possible serious personal injury.

⚠ WARNING

Do not insert the battery until assembly is complete. Failure to comply could result in accidental starting and possible serious personal injury.

ADDING BAR AND CHAIN LUBRICANT

Use a bar and chain lubricant with this product. It is designed for chains and chain oilers, and is formulated to perform over a wide temperature range with no dilution required.

- Remove oil cap. Open the removable cover (1) and then rotate the cover counterclockwise to remove it (2).
- Carefully pour the bar and chain oil into the tank (3).
- Wipe off excess oil and replace cap.
- Check and fill the oil tank when quick view oil indicator is below the MIN. line.
- Repeat as needed.

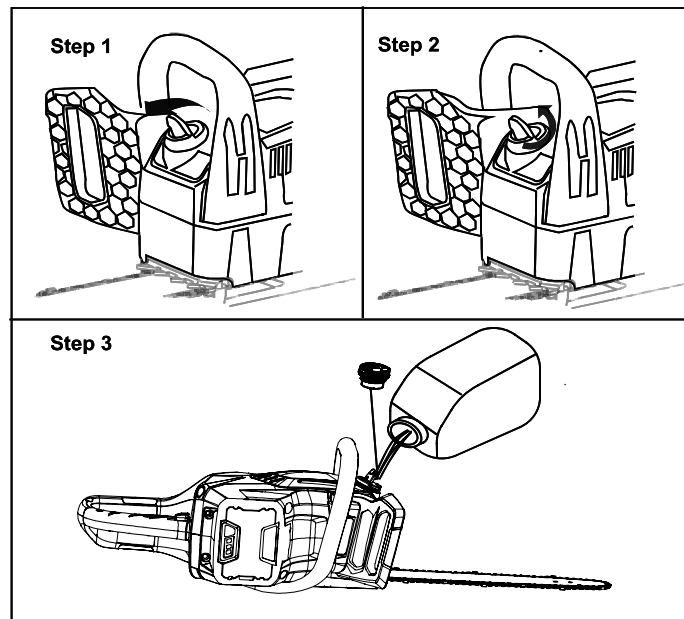

NOTE: Chainsaw comes from the factory with no bar and chain oil added. The level should also be checked after every 20 minutes of use and refilled as needed.

NOTE: Do not use dirty, used, or otherwise contaminated oils. Damage may occur to the bar or chain.

NOTE: It is normal for oil to seep from the saw when not in use. To prevent seepage, empty the oil tank after each use, then run for one minute. When storing the unit for a long period of time (three months or longer) be sure the chain is lightly lubricated; this will prevent rust on the chain and bar sprocket.

ASSEMBLY

▲ I M P O R T A N T

To preserve natural resources, please recycle or dispose of oil properly. Consult your local waste authority for information regarding available recycling and/disposal options.

BATTERY

TO INSTALL THE BATTERY:

1. Align the battery with the battery opening.
2. Insert the battery into the battery opening until the battery release button locks into place.
3. Push down on the battery until it locks into place. You should hear a “click” once it is installed.

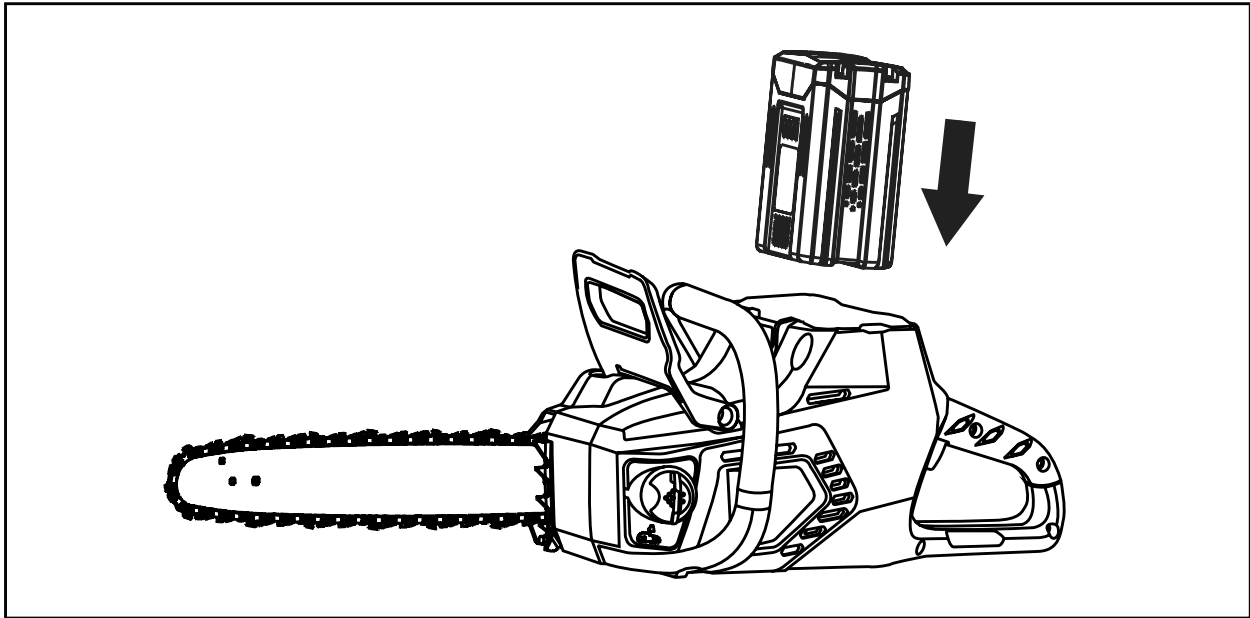

ASSEMBLY

TO REMOVE THE BATTERY:

1. Press the battery release button on the battery. This will cause the battery to raise out of the tool.
2. Grasp the chainsaw firmly and pull the battery out of the unit.

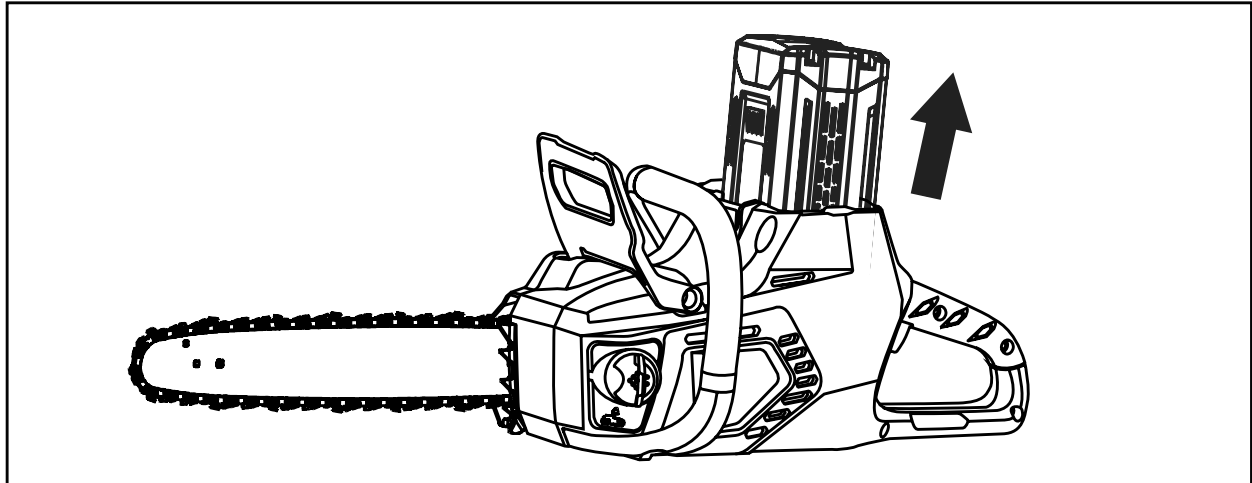

▲ I M P O R T A N T

The battery may not be charged when it is purchased. Before using the chainsaw for the first time, place the battery in the battery charger and charge it fully. Be sure to read all safety precautions and follow the instructions in the battery and charger manuals. When storing the chainsaw for a prolonged period of time, remove the battery. When the chainsaw is going to be used again, charge the battery for at least a full charging period. The battery has no memory effect.

▲ W A R N I N G

Follow these instructions in order to avoid injury and to reduce the risk of electric shock or fire:

- Replace the battery or the charger immediately if the battery case or charger cord is damaged.
 - Read, understand, and follow the instructions contained in the charger manual.
-

OPERATION

STARTING AND STOPPING THE CHAINSAW

A. Starting the Chainsaw:

- Make sure chain tension is at desired setting. Refer to adjusting the chain tension in the Care and Maintenance section of this manual.
- Make sure the bar nuts are tight on the bar cover.
- Make sure no objects or obstructions are in the immediate vicinity which could come in contact with the bar and chain.
- Insert the battery into the chainsaw.
- Press in the safety lock. This makes the trigger operational.
- Press and hold the trigger, and keep it pressed for continued operation.

B. Stopping the Chainsaw

- Release the trigger.
- Upon release of the trigger, the safety lock will be automatically reset to the lock position.
- This chain saw is equipped with a mechanical chain brake which is designed to stop a moving chain in a fraction of a second if kickback occurs, reducing the chances of severe injury. To manually engage the chain brake push the chain brake forward. This action will lock the chain from moving; to release the chain brake, pull the brake toward the handle. This will reset the chain brake.

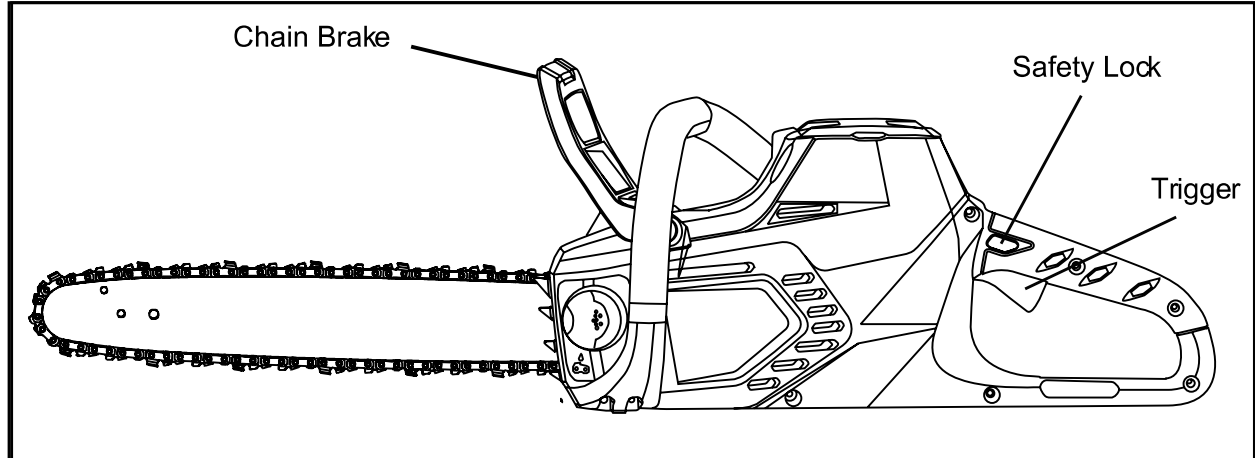

NOTE: Once the trigger switch is released, the mechanical brake will engage stopping the chain.

NOTE: It is normal for the chain to coast to a stop once the trigger is released.

OPERATION

OPERATING THE CHAIN BRAKE

Check the operating condition of the chain brake prior to each use.

- Engage the chain brake by rotating your left wrist towards the guard, allowing the back of your hand to engage the brake while the chain is rotating. Be sure to maintain both hands on the saw handles at all times.

▲ WARNING

If the chain brake does not stop the chain immediately, or if the chain brake will not stay in the on position without assistance, take the saw to an authorized service center for repair prior to use.

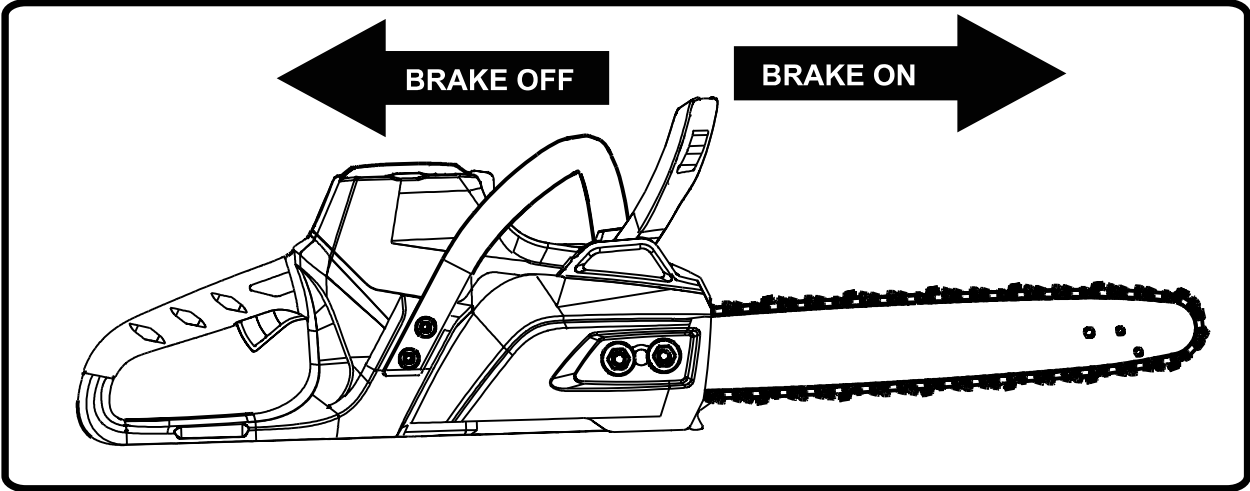

OPERATION

PREPARING FOR CUTTING

Proper grip on handles

See Safety Rules for appropriate safety equipment.

- Wear non-slip gloves for maximum grip and protection.
- Hold the saw firmly with both hands. Always keep your left hand on the front handle and your right hand on the rear handle so that your body is to the left of the chain line.
- Maintain a proper grip on the saw whenever the motor is running. The fingers should encircle the handle and the thumb is wrapped underneath. This grip is least likely to be broken by a kickback or other sudden reaction of the saw. Any grip in which the thumb and fingers are on the same side of the handle is dangerous because a slight kickback of the saw can cause loss of control.

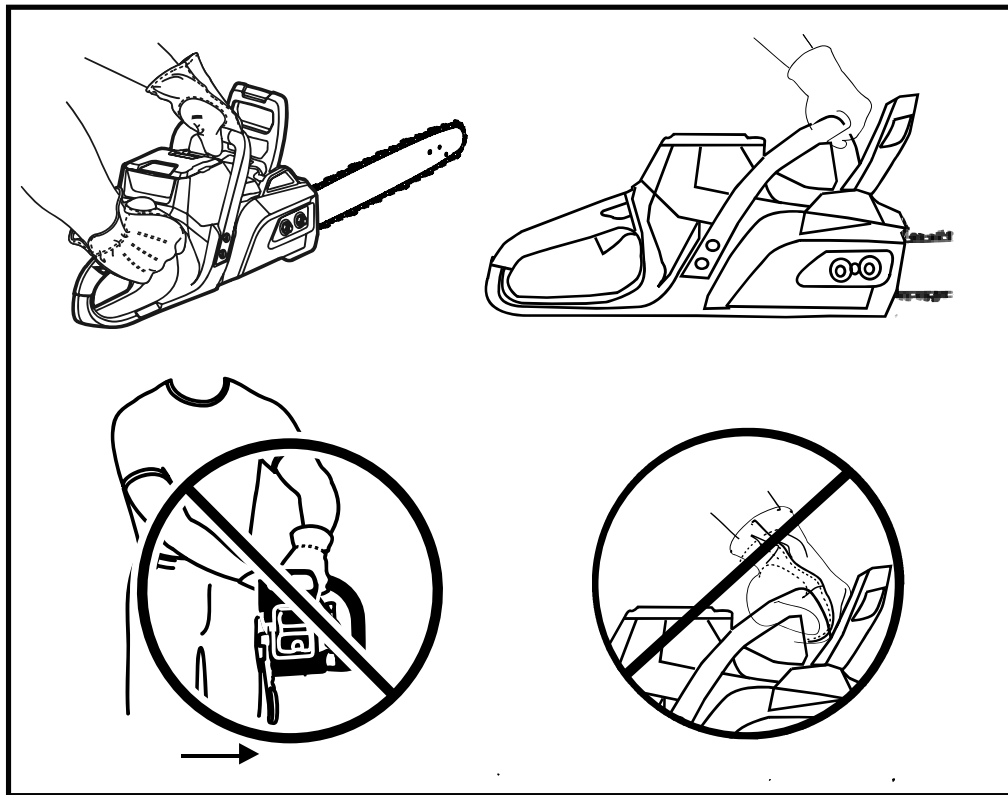

▲ WARNING

DO NOT operate the trigger with your left hand and hold the front handle with your right hand. Never allow any part of your body to be in the chain line while operating a saw. Never use a left-handed (cross-handed) grip or any stance that would place your body or arm across the chain line.

OPERATION

PROPER CUTTING STANCE

- Balance your weight with both feet on solid ground.
- Keep left arm with elbow locked in a “straight arm” position to withstand any kickback force.
- Keep your body to the left of the chain line.
- Keep your thumb on underside of front handle.

BASIC OPERATING/CUTTING PROCEDURES

Practice cutting a few small logs using the following technique to get the “feel” of using the saw before you begin a major sawing operation.

- Take the proper stance in front of the wood.
- Press the safety lock in and squeeze the trigger, then release the safety lock and let the chain accelerate to full speed before entering the cut.
- Begin cutting with the saw against the log.
- Keep the unit running the entire time you are cutting, maintain a steady speed.
- The chain will cut for you; **exert only light downward pressure.** Forcing the cut could result in damage to the bar, chain, or motor.
- Release the trigger as soon as the cut is completed, allowing the chain to stop. If you run the saw without a cutting load, unnecessary wear can occur to the chain, bar, and unit.
- Do not put pressure on the saw at the end of the cut.

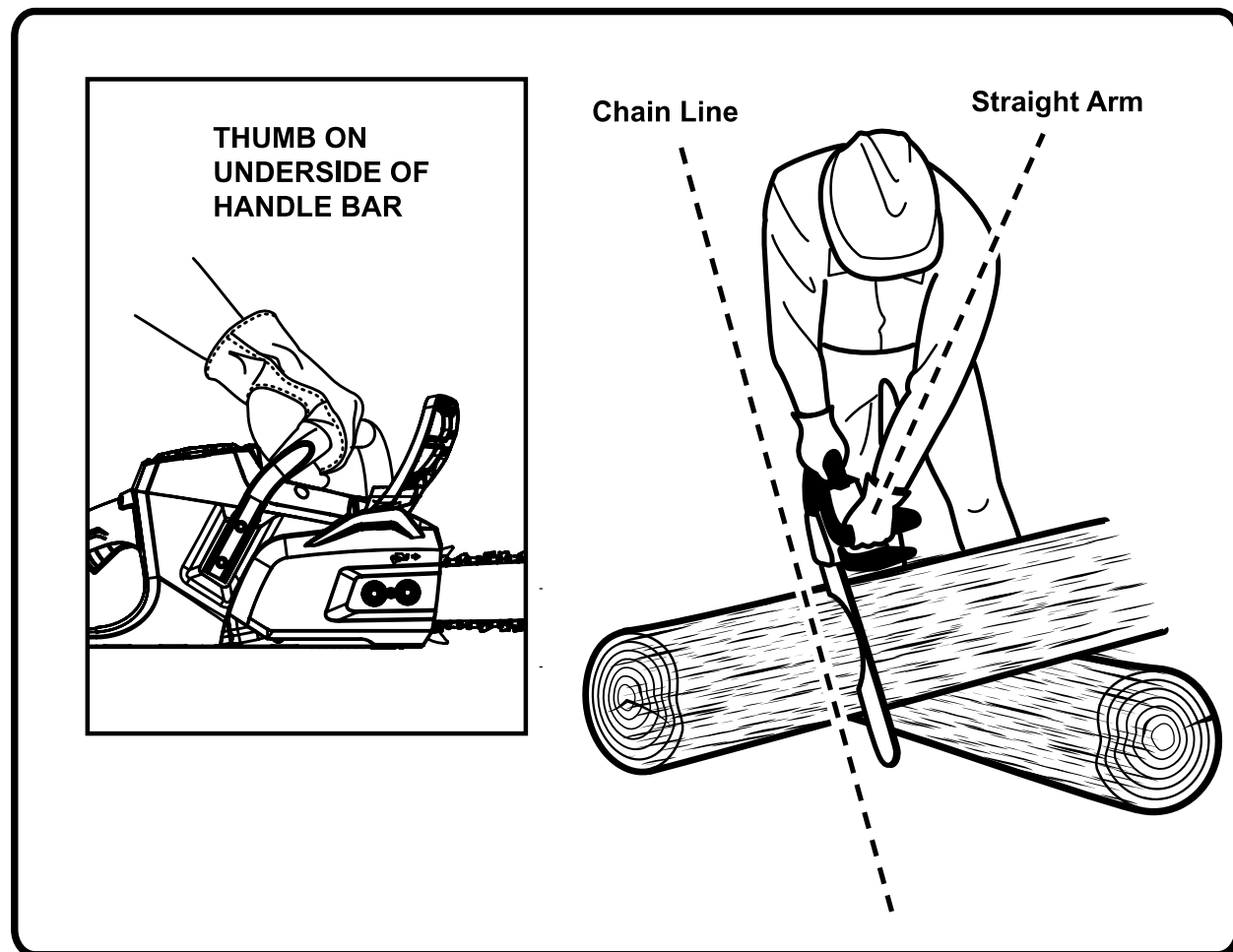

OPERATION

REMOVING BUTTRESS ROOTS

A buttress root is a large root extending from the trunk of the tree above the ground. Remove large buttress roots prior to felling. Make the horizontal cut into the buttress first, followed by the vertical cut. Remove the resulting loose section from the work area. Follow the correct tree felling procedure as stated in Proper Procedure For Tree Felling after you have removed the large buttress roots.

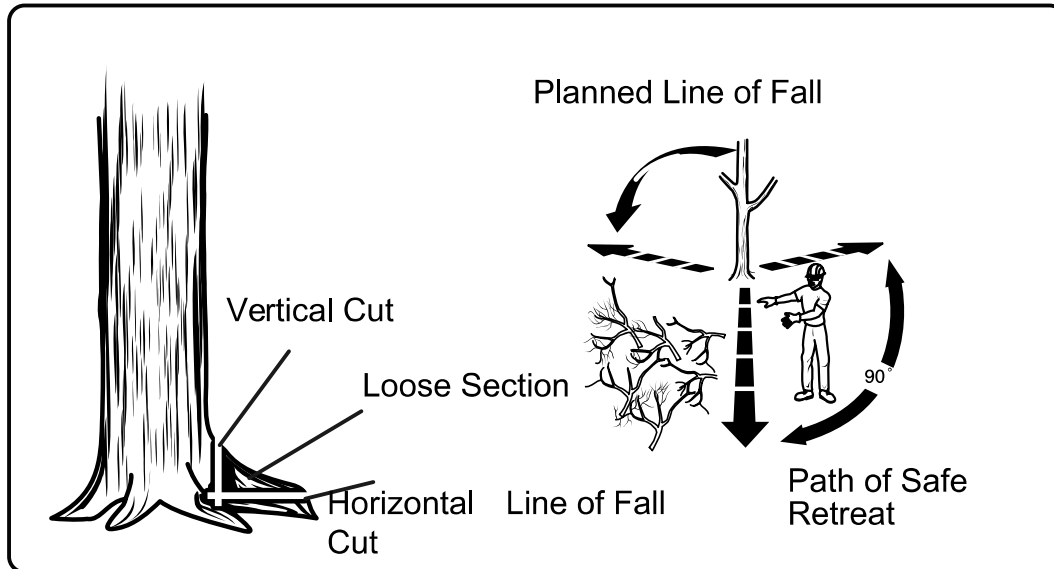

PROPER PROCEDURE FOR TREE FELLING

- Felling a tree — When bucking and felling operations are being performed by two or more persons at the same time, the felling operation should be separated from the bucking operation by a distance of at least twice the height of the tree being felled. Trees should not be felled in a manner that would endanger any person, strike any utility line or cause any property damage. If the tree does make contact with any utility line, the utility company should be notified immediately.
- Operator should keep on the uphill side of terrain as the tree is likely to roll or slide after it is felled.
- Pick your escape route (or routes in case the intended route is blocked). Clear the immediate area around the tree and make sure there are no obstructions in your planned path of retreat. Clear the path of safe retreat approximately 135° from the planned line of fall.
- Consider the force and direction of the wind, the lean and balance of the tree, and the location of large limbs. These things influence the direction in which the tree will fall. Do not try to fell a tree along a line different from its natural line of fall.
- Remove dirt, stones, loose bark, nails, staples, and wire from the tree where felling cuts are to be made.
- Notched Undercut. Cut a notch about 1/3 the diameter of the trunk on the side of the tree. Make the notch cuts so they intersect at a right angle to the line of fall. This notch should be cleaned out to leave a straight line. To keep the weight of the wood off the saw, always make the lower cut of the notch before the upper cut.

OPERATION

- Felling Backcut. As the felling cut gets close to the hinge, the tree should begin to fall. If there is any chance the tree may not fall in the desired direction or it may rock back and bind the saw chain, stop cutting before the felling cut is complete and use wedges of wood, plastic or aluminum to open the cut and drop the tree along its desired line of fall. Make the backcut level and horizontal, and at a minimum of 2 in. (5 cm) above the horizontal cut of the notch.
- On large diameter trees, stop the back cut before it is deep enough for the tree to either fall or settle back on the stump. Then insert soft wooden or plastic wedges into the cut so they do.
- As tree starts to fall, stop the chainsaw and put it down immediately. Retreat along the cleared path, but watch the action in case something falls your way.

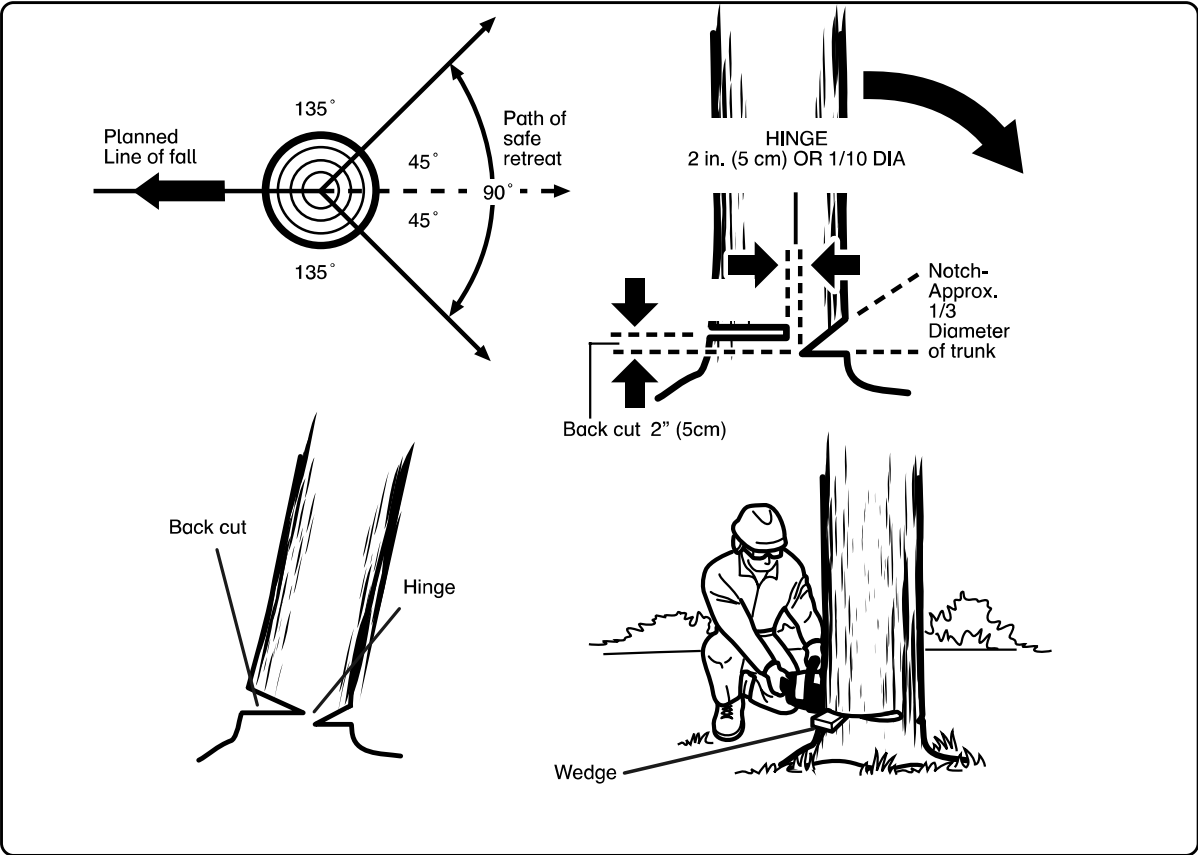

OPERATION

BUCKING

Bucking is the term used for cutting a fallen tree to the desired log length.

- Always make sure your footing is secure and your weight is distributed evenly on both feet.
- Cut only one log at a time.
- Support small logs on a saw horse or another log while bucking.
- Keep a clear cutting area. Make sure that no objects can contact the guide bar nose and chain during cutting as this can cause kickback. Refer to Kickback earlier in this manual.
- When bucking on a slope, always stand on the uphill side of the log. To maintain complete control of the chainsaw when cutting through the log, release the cutting pressure near the end of the cut without relaxing your grip on the chainsaw handles. Do not let the chain contact the ground. After completing the cut, wait for the saw chain to stop before you move the chainsaw. Always stop the motor before moving from tree to tree.

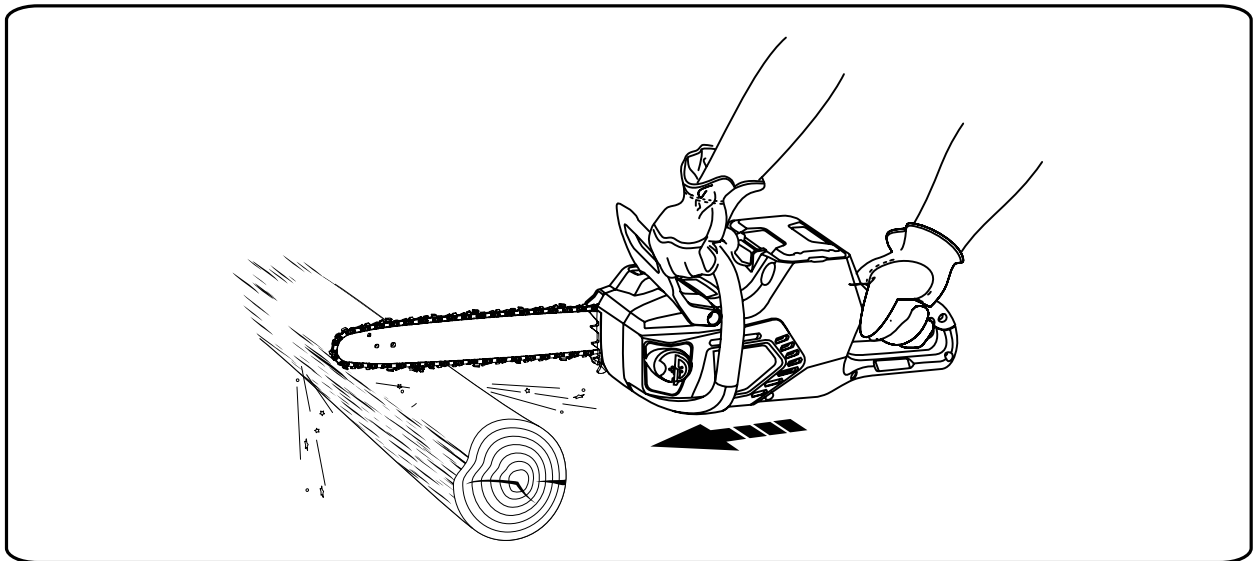

BUCKING WITH A WEDGE

If the wood diameter is large enough for you to insert a soft bucking wedge without touching the chain, you should use the wedge to hold the cut open to prevent pinching.

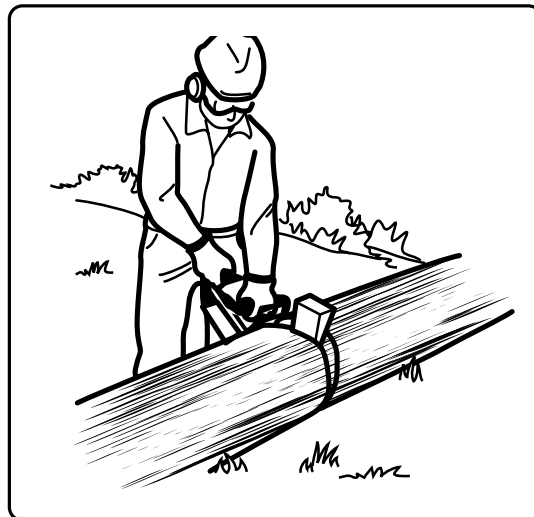

OPERATION

BUCKING LOGS UNDER STRESS

When the log is supported on one end, cut 1/3 the diameter from the underside. Then make the finished cut by overbucking to meet the first cut. When the log is supported on both ends, cut 1/3 of the diameter from the top overback. Then make the finished cut by under bucking the lower 2/3 to meet the first cut.

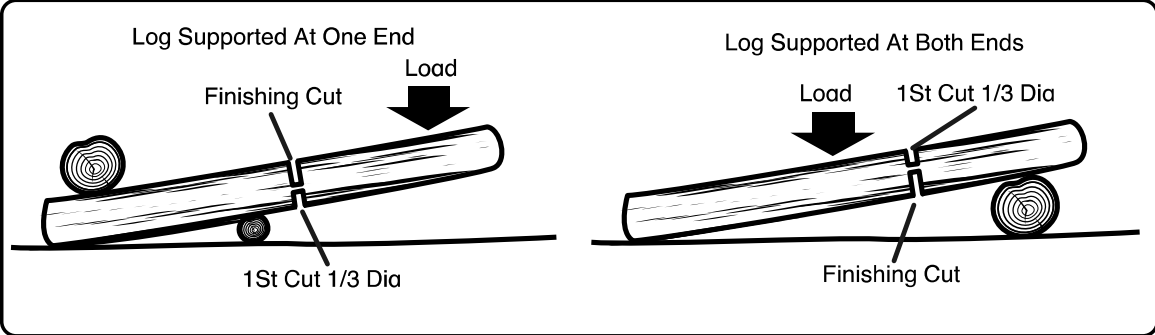

OVERBUCKING

Begin on the top side of the log with the bottom of the saw against the log; exert light pressure downward. Note that the saw will tend to pull away from you.

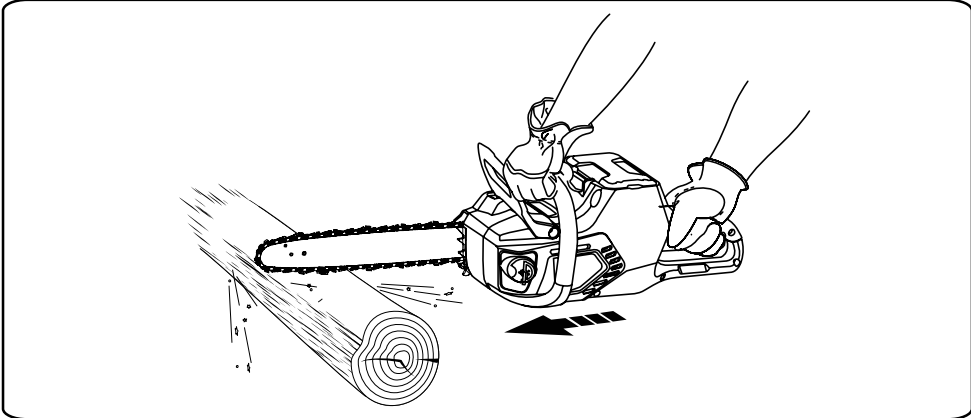

UNDERBUCKING

Begin on the under side of the log with the top of the saw against the log; exert light pressure upward. During under bucking, the saw will tend to push back at you. Be prepared for this reaction and hold the saw firmly to maintain control.

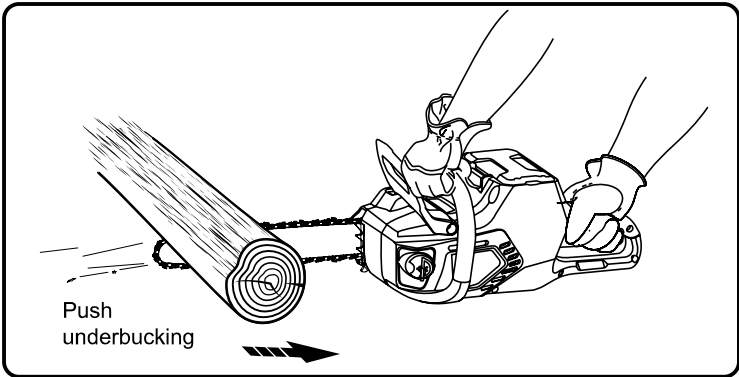

OPERATION

LIMBING

Limbing is removing branches from a fallen tree.

- Work slowly, keeping both hands on the chainsaw with a firm grip. Always make sure your footing is secure and your weight is distributed evenly on both feet.
- Leave the larger support limbs under the tree to keep the tree off the ground while cutting.
- Limbs should be cut one at a time. Remove the cut limbs from the work area often to help. Keep the work area clean and safe.
- Branches under tension should be cut from the bottom up to avoid binding the chain saw.
- Keep the tree between you and the chainsaw while limbing. Cut from the side of the tree opposite the branch you are cutting.

PRUNING

Pruning is trimming limbs from a live tree.

- Work slowly, keeping both hands on the chainsaw with a firm grip. Always make sure your footing is secure and your weight is distributed evenly on both feet.
- Do not cut from a ladder. This is extremely dangerous. Leave this operation for professionals.
- Do not cut above chest height as a saw held higher is difficult to control against kickback.
- When pruning trees it is important not to make the finishing cut next to the main limb or trunk until you have cut off the limb further out to reduce the weight. This prevents stripping the bark from the main member.
- Underbuck the branch 1/3 through for your first cut.
- Your second cut should overbuck to drop the branch off.
- Now make your finishing cut smoothly and neatly against the main member so the bark will grow back to seal the wound.

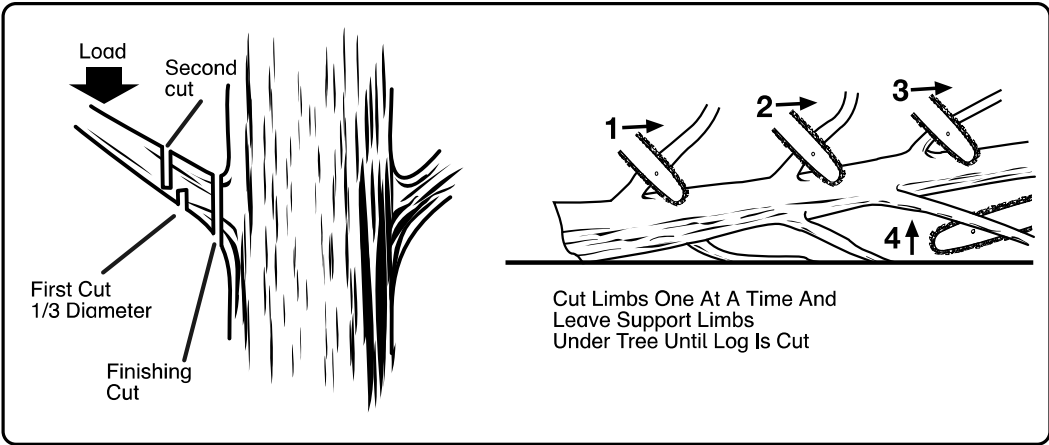

OPERATION

When bucking on a slope always stand on the uphill side of the log. When cutting through to maintain complete control release the cutting pressure near the end of the cut without relaxing your grip on the chainsaw handle. Do not let the chain contact the ground. After completing the cut, wait for the saw chain to stop before you move the chainsaw. Always stop the motor before moving from tree to tree.

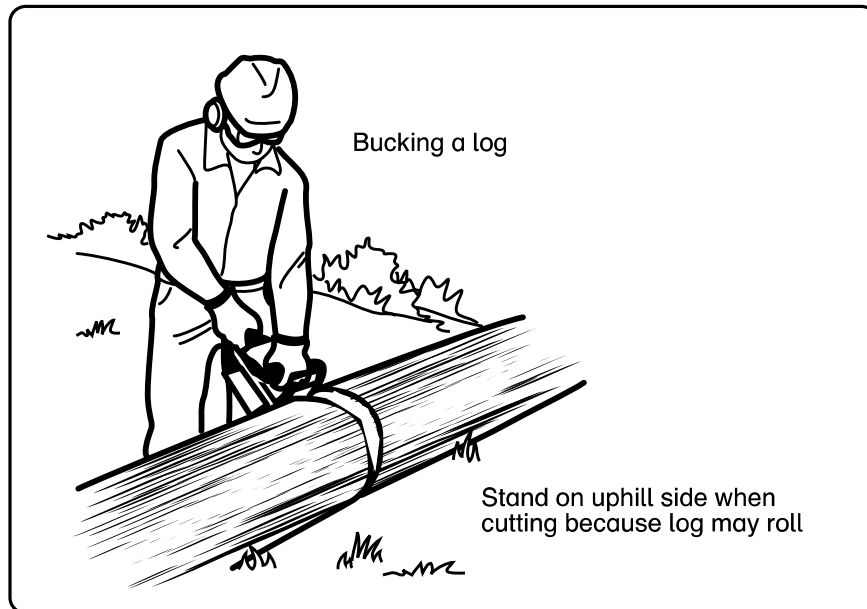

CUTTING SPRINGPOLES

A springpole is any log, branch, rooted stump, or sapling which is bent under tension by other wood so that it springs back if the wood holding it is cut or removed. On a fallen tree, a rooted stump has a high potential of springing back to the upright position during the bucking cut to separate the log from the stump. Watch out for springpoles — they are dangerous.

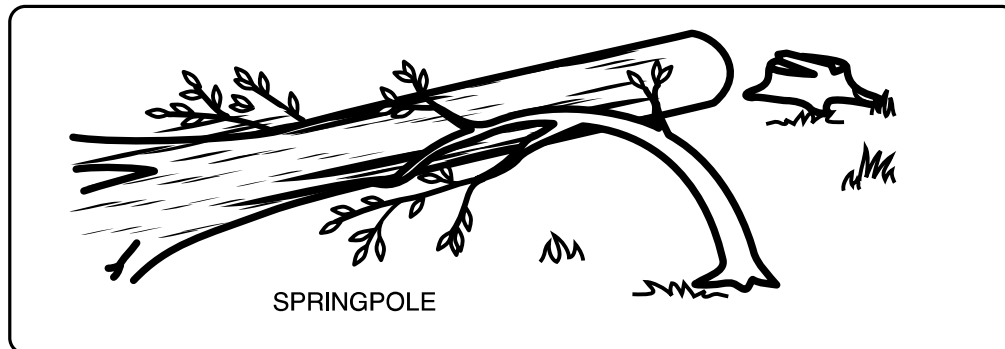

▲ WARNING

If the limbs to be pruned are above chest height, hire a professional to perform the pruning.

▲ WARNING

Springpoles are dangerous and could strike the operator, causing the operator to lose control of the chain saw. This could result in severe or fatal injury to the operator.

BATTERY & CHARGER MAINTENANCE

CHARGING PROCEDURE

NOTE: *The battery is not shipped fully charged. It is recommended to fully charge before first use to ensure that maximum run time can be achieved. This lithium-ion battery will not develop a memory and may be charged at any time.*

Low voltage charging:

If the battery has been stored with little to no charge for a long period of time, the charger will go into recovery mode, which will take 20 hrs to fully charge the battery. This will enhance the life of the battery. Once it is fully charged, the next charge will return to standard charging.

A fully discharged battery pack will require the allotted time as stated in the battery manual.

- Plug the charger into an AC power outlet.
- Insert the battery into the charger.

This is a diagnostic charger. The Charger LED Lights will illuminate in specific order to communicate the current battery status. They are as follows:

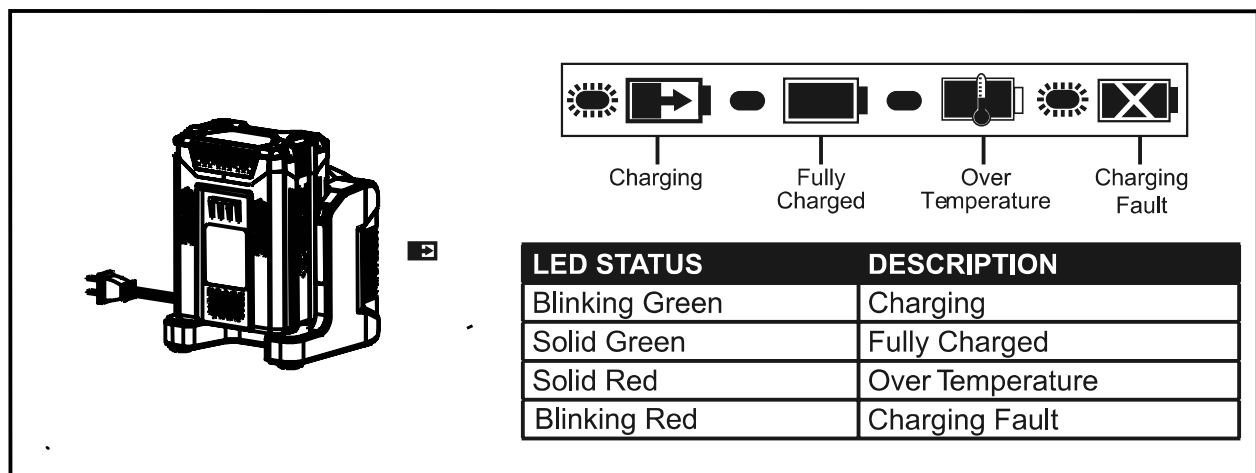

The diagram shows a diagnostic charger with a battery pack inserted. To the right of the charger is a legend for the LED status indicators. The legend consists of a horizontal row of five icons: a glowing green circle, a battery with a right-pointing arrow, a solid green battery, a battery with a thermometer, a glowing red circle, and a battery with an 'X' over it. Below each icon is a label: 'Charging', 'Fully Charged', 'Over Temperature', and 'Charging Fault'. Below the legend is a table with two columns: 'LED STATUS' and 'DESCRIPTION'.

LED STATUS	DESCRIPTION
Blinking Green	Charging
Solid Green	Fully Charged
Solid Red	Over Temperature
Blinking Red	Charging Fault

False defect note:

When the battery is inserted into the charger and the status LED blinks RED, remove the battery from the charger for 1 minute, then reinsert. If the status LED blinks GREEN, then the battery is properly charging. If the status LED is still blinking RED, remove the battery and unplug the charger for 1 minute.

After 1 minute, plug in the charger and reinsert the battery. If the status LED blinks GREEN, then the battery is properly charging. If the status LED is still blinking RED, the battery is defective and needs to be replaced.

BATTERY & CHARGER MAINTENANCE

CHECKING THE CHARGE

If the battery pack does not charge properly:

- Check the current at the power outlet with another tool. Make sure that the outlet is not turned off.
- Check that the charger contacts have not been shorted by debris or foreign material.
- If the air temperature is above 104°F (40°C) or below 45°F (7°C), move the charger and battery pack to a room temperature location.

⚠ WARNING

If the battery is inserted into the charger when warm or hot, the CHARGING LED indicator light on the charger may switch on and illuminate RED. If this occurs allow the battery to cool inside of the charger for up to 30 minutes. Charging should automatically start once battery has cooled.

CHARGER MOUNTING

1. This charger can be installed on a wall using two #8 screws (not included).
2. Locate the desired placement for the charger to be mounted.
3. If fastening to wood studs use 2 wood screws (not included).
4. Drill two holes 4.5 in (11.4 cm) apart ensuring that they are vertically aligned.
5. If fastening to drywall use wall anchors (not included) and screws to secure the charger to the wall.

NOTE: *If the battery and the charger won't be used for a long time, please remove the battery from the charger and pull out the AC power plug.*

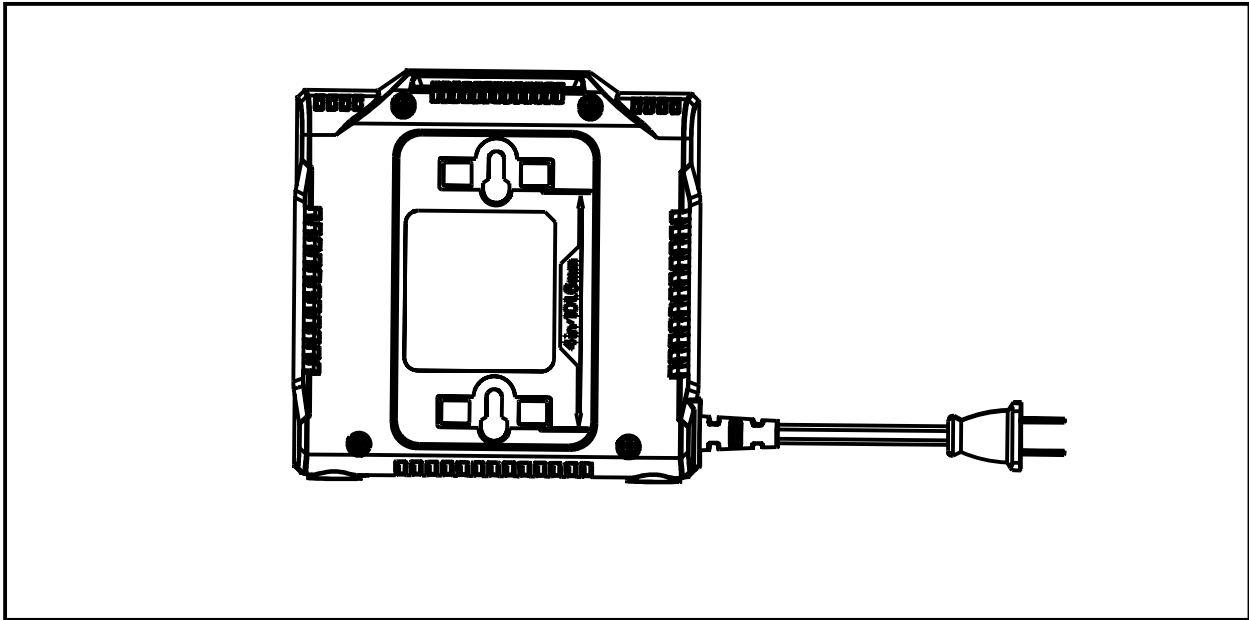

MAINTENANCE

GENERAL MAINTENANCE

Avoid using solvents when cleaning plastic parts. Most plastics are susceptible to damage from various types of commercial solvents and may be damaged by their use. Use clean cloths to remove dirt, dust, lubricant, grease, etc., firmly to maintain control.

- Do not at any time let brake fluids, gasoline, petroleum-based products, penetrating oils, etc., come in contact with plastic parts. Chemicals can damage, weaken, or destroy plastic, which may result in serious personal injury.

LUBRICATION

- All of the bearings in this product are lubricated with a sufficient amount of high grade lubricant for the life of the unit under normal operating conditions. Therefore, no further lubrication is required.

⚠ WARNING

- When servicing, use only identical replacement parts. Use of any other parts may create a hazard or cause product damage.
- Always wear safety goggles or safety glasses with side shields during power tool operation or when blowing dust. If the operation is dusty, also wear a dust mask.

⚠ WARNING

Never start the motor before installing the guide bar, chain, bar cover, and bar nuts. Without all these parts in place, the clutch can fly off or explode, exposing the user to possible serious injury.

⚠ WARNING

- To avoid serious personal injury, read and understand all the safety instructions in this section.
- Before performing any maintenance, make sure the battery is removed. Failure to heed this warning could result in serious personal injury.

⚠ WARNING

Always wear gloves when handling the bar and chain; these components are sharp and may contain burrs.

Never touch or adjust the chain while the motor is running. The saw chain is very sharp; always wear protective gloves when performing maintenance to the chain to avoid possible serious lacerations.

NOTE: When replacing the guide bar and chain, always use the specified bar and chain listed in the bar and chain combinations section later in this manual.

MAINTENANCE

REPLACING THE GUIDE BAR AND CHAIN

- Remove the battery from the chain saw.
- Remove the two chain cover lock nuts from the chain cover by rotating them counterclockwise with the wrench.

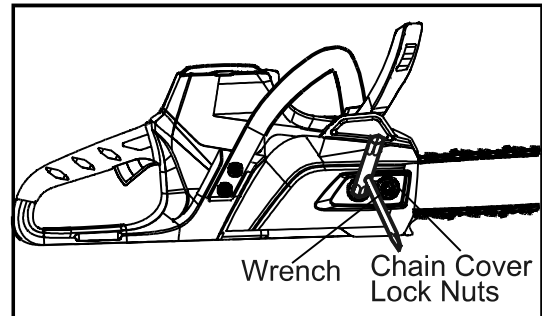

- Remove the chain cover from the mounting surface.
- The bar and chain can now be removed by lifting it away from the main body of the saw and releasing the chain from the sprocket.
- Remove the old chain from the bar.

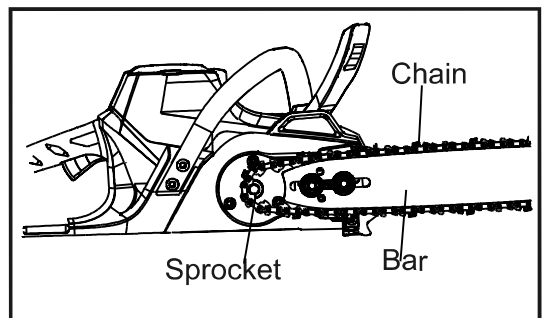

- Lay out the new saw chain in a loop and straighten any kinks. The cutters should face in the direction of chain rotation. If they face backwards, turn the loop over.
- Place the chain drive links into the bar groove.

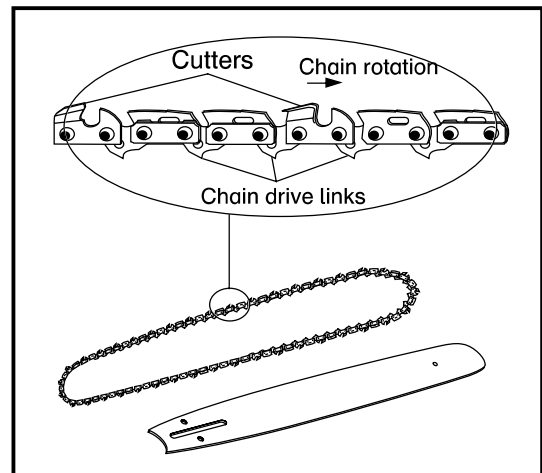

MAINTENANCE

NOTE: Make certain of direction of the chain.

- Position the chain so there is a loop at the back of the bar.
- Hold the chain in position on the bar and place the loop around the sprocket.
- Fit the bar flush against the mounting surface so that the bar studs are in the long slot of the bar. Ensure that the chain is over the sprocket.

NOTE: When placing the bar on the bar studs, ensure that the adjusting pin is in the chain tension pin hole.

- Replace the chain cover.
- Remove all slack from the chain by turning the chain adjustment screw clockwise until the chain seats snugly against the bar with the drive links in the bar groove.

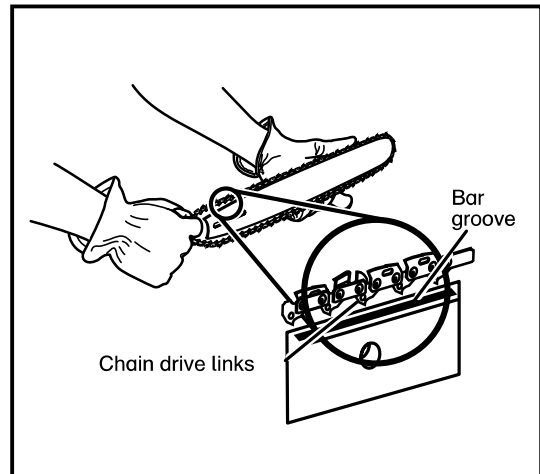

- Lift the tip of the guide bar up to check for sag.
- Release the tip of the guide bar and turn the chain adjustment screw 1/2 turn clockwise. Repeat this process until sag does not exist.
- Hold the tip of the guide bar up and tighten the chain cover lock nuts by turning them with the wrench.
- The chain is correctly tensioned when there is no sag on the underside of the guide bar, the chain is snug, but it can be turned by hand without binding.

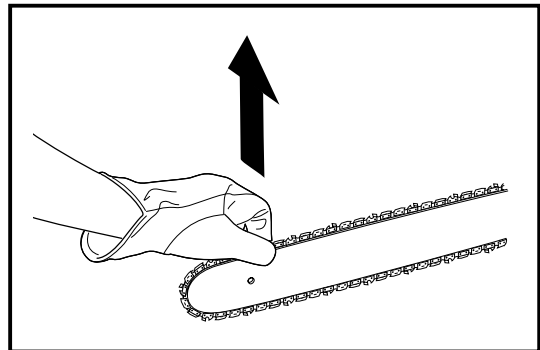

NOTE: If the chain is too tight, it will not rotate. Loosen the chain cover lock nuts slightly and turn the chain adjustment screw 1/4 turn counterclockwise. Lift the tip of the guide bar up and retighten the chain cover lock nuts. Ensure that the chain will rotate without binding.

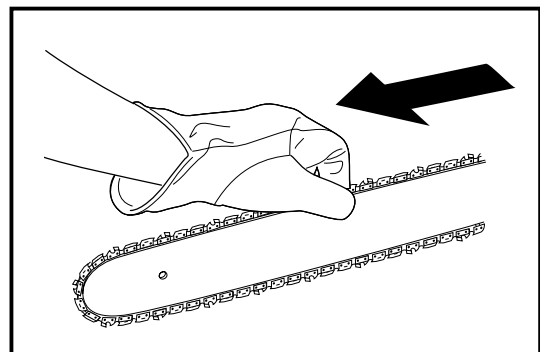

MAINTENANCE

ADJUSTING THE CHAIN TENSION

▲ W A R N I N G

Never touch or adjust the chain while the motor is running. The saw chain is very sharp. Always wear protective gloves when performing maintenance on the chain.

- Loosen the chain cover lock nuts with the supplied wrench. The chain cover lock nuts do not have to be completely removed in order to adjust the chain tension.
- Rotate the chain adjustment screw clockwise to increase the chain tension and rotate counterclockwise to decrease the chain tension.
- Once the chain is at the desired tension, tighten the chain cover lock nuts.

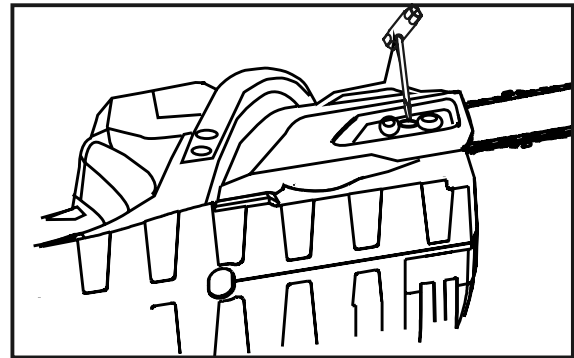
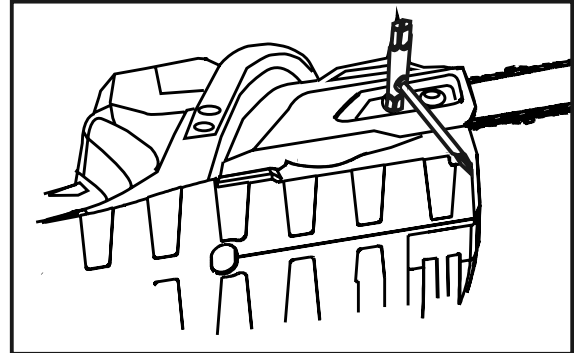

NOTE: During normal saw operation, the temperature of the chain increases. The drive links of a correctly tensioned warm chain will hang approximately 1/16 in. (1,58 mm) out of the bar groove.

NOTE: New chains tend to stretch; check the chain tension frequently and tension as required.

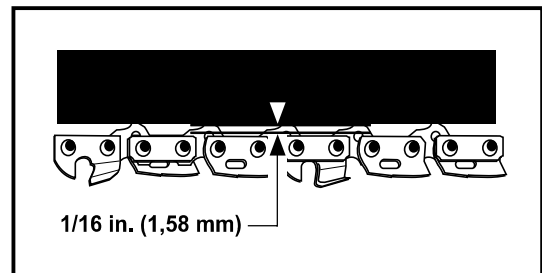

MAINTENANCE

CHAIN MAINTENANCE

Use only a low-kickback chain on this saw. This fast-cutting chain provides kickback reduction when properly maintained. For smooth and fast cutting, maintain the chain properly. The chain requires sharpening when the wood chips are small and powdery, the chain must be forced through the wood during cutting, or the chain cuts to one side. During maintenance of the chain, consider the following:

- Improper filing angle of the side plate can increase the risk of severe kickback
- Raker (depth gauge) clearance.
- Too low increases the potential for kickback.
- Not low enough decreases cutting ability.
- If the cutter teeth hit hard objects such as nails or stones, or are abraded by mud or sand on the wood, have an authorized service center sharpen the chain.

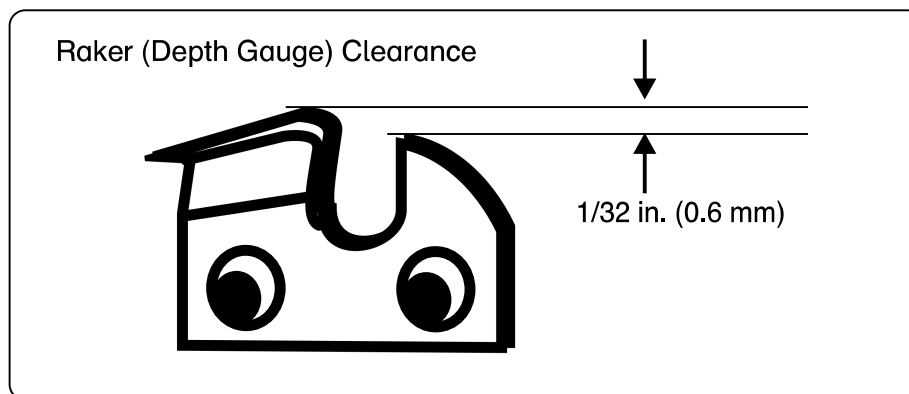

NOTE:

- Inspect the sprocket for wear or damage when replacing the chain. If signs of wear or damage are present in the areas indicated, have the sprocket replaced by an authorized service center.
- If you do not fully understand the correct procedure for sharpening the chain after reading the instructions that follow, have the saw chain sharpened by an authorized service center or replace with a recommended low-kickback chain.

MAINTENANCE

SHARPENING THE CUTTERS

- Be careful to file all cutters to the specified angles and to the same length, as fast cutting can be obtained only when all cutters are uniform.
- Tension the chain prior to sharpening. Refer to Page 31.
- Use a 5/32 in. (4 mm) diameter round file and holder. Do all of your filing at the midpoint of the bar.
- Keep the file level with a top plate of the tooth. Do not let the file dip or rock.
- Using light but firm pressure. Stroke towards the front corner of the tooth.
- Lift the file away from the steel on each return stroke.
- Put a few firm strokes on every tooth. File all left hand cutters in one direction. Then move to the other side and file the right hand cutters in the opposite direction.
- Remove filings from the file with a wire brush.

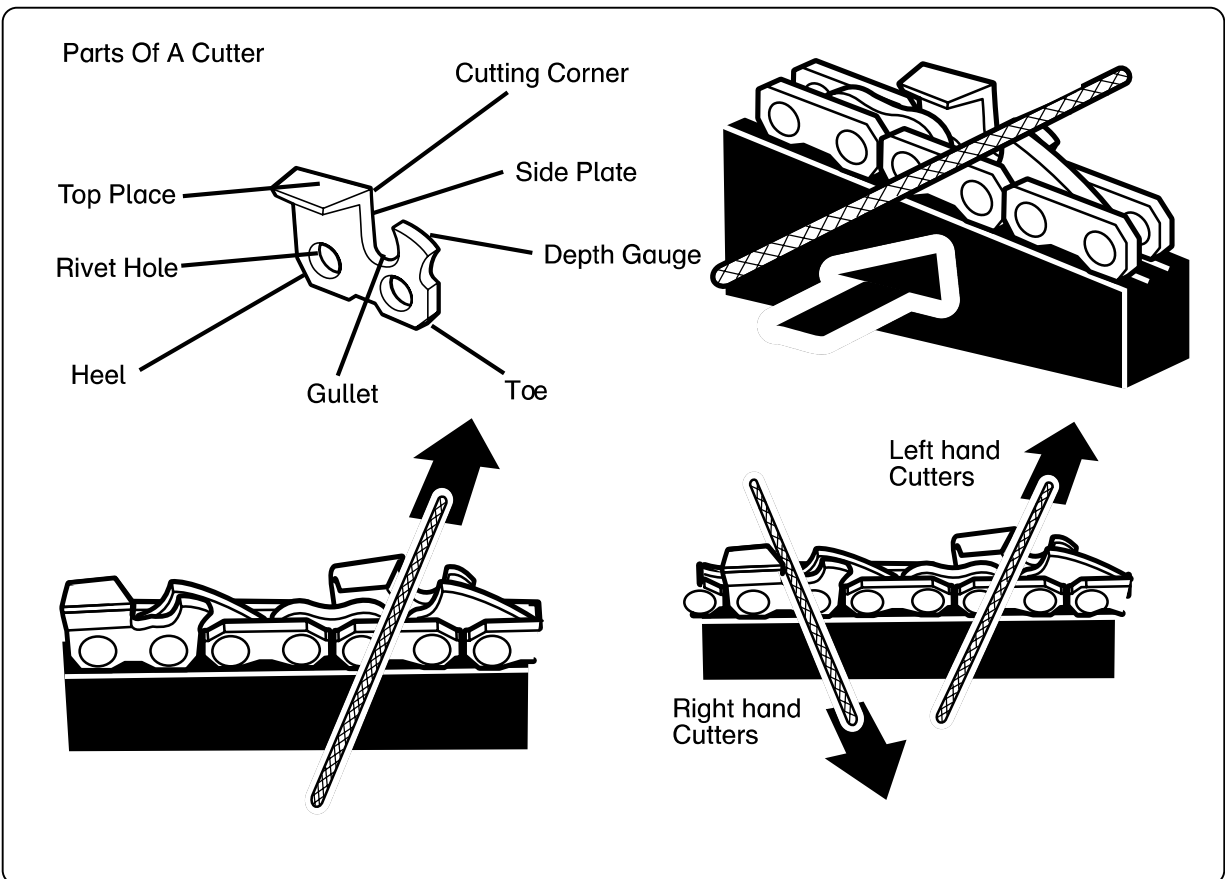

⚠ WARNING

- Make sure the battery is removed from the chain saw before you work on the saw.
- The saw chain is very sharp. Always wear protective gloves when performing maintenance to the chain to prevent serious personal injury.
- A dull or improperly sharpened chain can cause excessive motor speed during cutting, which may result in severe motor damage.

MAINTENANCE

TOP PLATE FILING ANGLE

- CORRECT 30° – file holders are marked with guide marks to align file properly to produce correct top plate angle.
- LESS THAN 30° – for cross cutting.
- MORE THAN 30° – feathered edge dulls quickly.

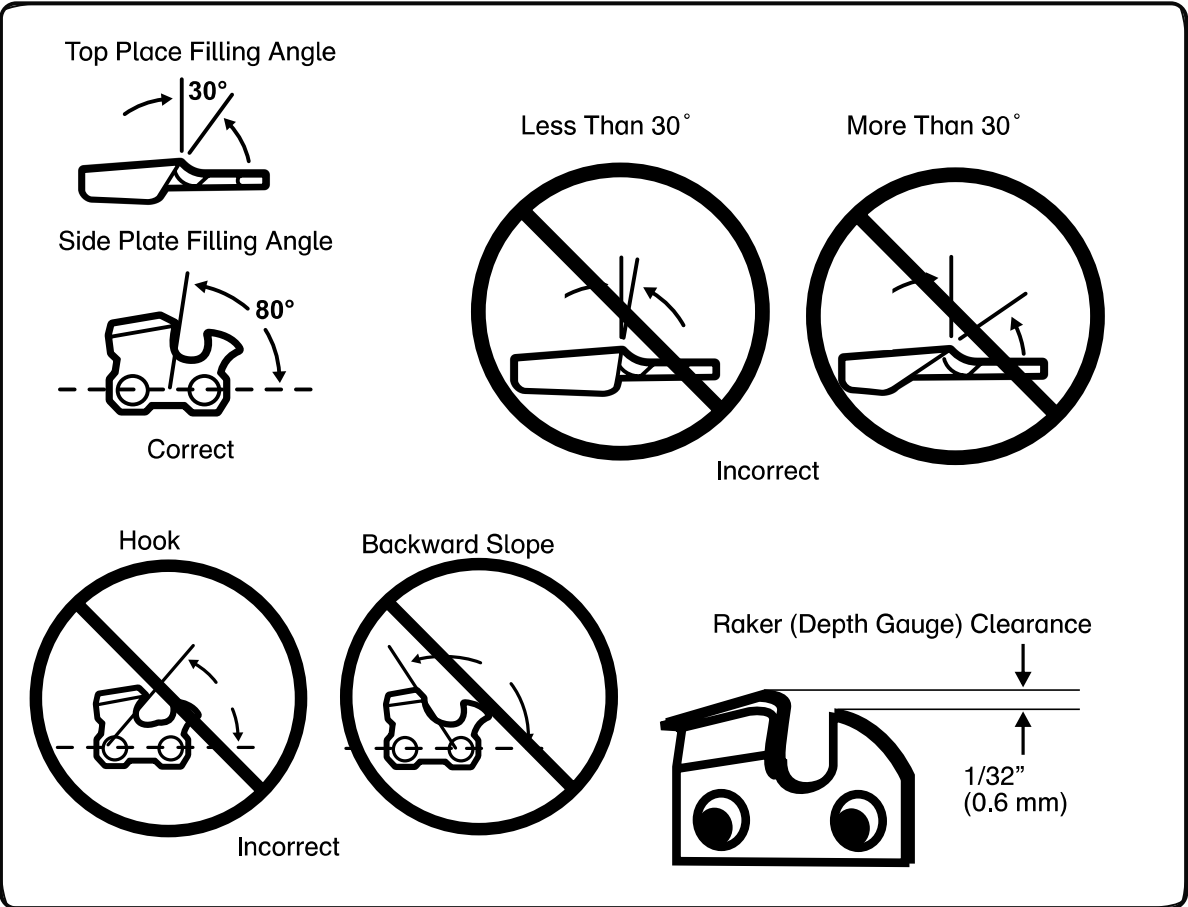

SIDE PLATE ANGLE

- Correct 80° – Produced automatically if you use the correct diameter file in the file holder.
- Hook – “Grabs” and dulls quickly; increases the potential of kickback. Results from using a file with a diameter too small or a file held too low.
- Backward Slope – Needs too much feed pressure; causes excessive wear to the bar and chain. Results from using a file with a diameter too large or file held too high.

MAINTENANCE

SIDE PLATE ANGLE

- Maintain the depth gauge at a clearance of 1/32 in. (0.6 mm). Use a depth gauge tool for checking the depth gauge clearances.
- Every time the chain is filed, check the depth gauge clearance.
- Use a flat file and a depth gauge jointer to lower all gauges uniformly. Use a 1/32 in. (0.6 mm) depth gauge jointer. After lowering each depth gauge, restore original shape by rounding the front. Be careful not to damage adjoining drive links with the edge of the file.
- Depth gauges must be adjusted with the flat file in the same direction the adjoining cutter was filed with the round file.
- Use care not to contact cutter face with flat file when adjusting depth gauges.

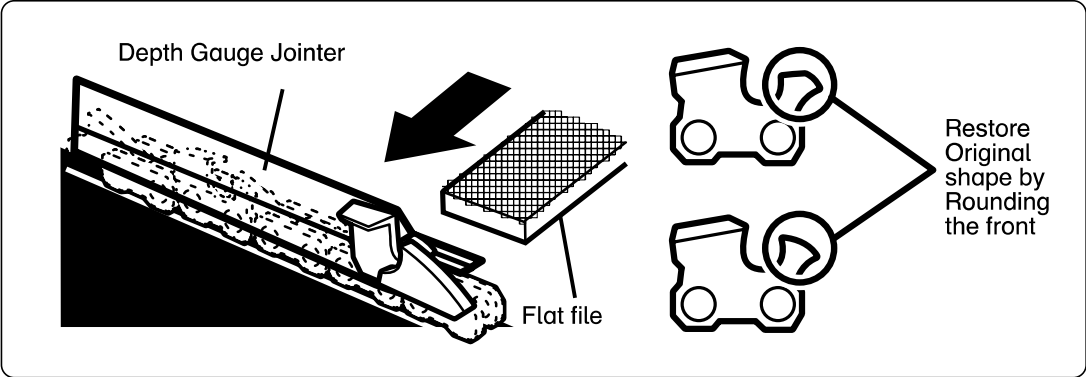

MAINTAINING THE GUIDE BAR

Every week of use, reverse the guide bar on the saw to distribute the wear for maximum bar life. The bar should be cleaned every day of use and checked for wear and damage. Feathering or burring of the bar rails is a normal process of bar wear. Such faults should be smoothed with a file as soon as they occur. A bar with any of the following faults should be replaced:

- Wear inside the bar rails that permits the chain to lay over sideways
- Bent guide bar
- Cracked or broken rails
- Spread rails

Lubricate guide bars weekly with a sprocket at their tip. Using a grease syringe, lubricate weekly in the lubricating hole. Turn the guide bar and check that the lubrication holes and chain groove are free from impurities.

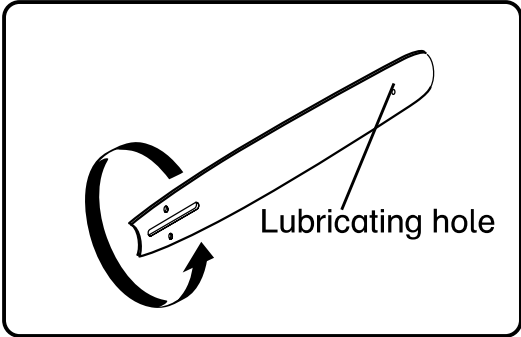

MAINTENANCE

QUICK REFERENCE OF CHAIN & BAR ASSEMBLY

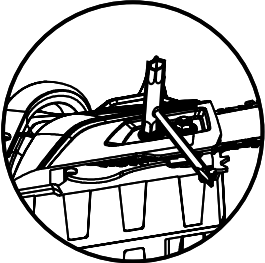
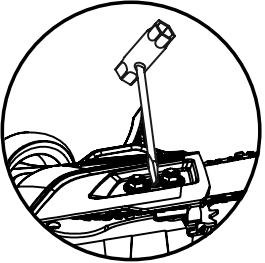
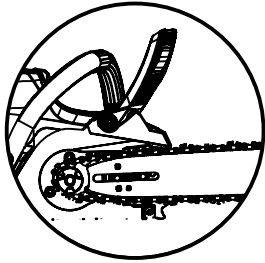
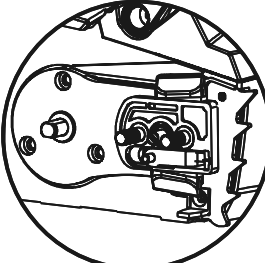
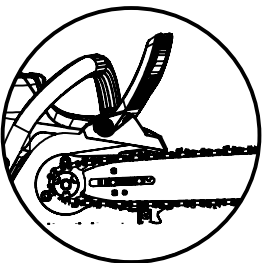
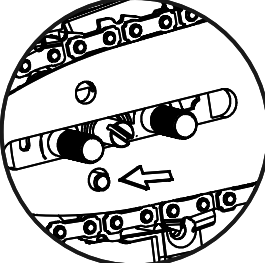
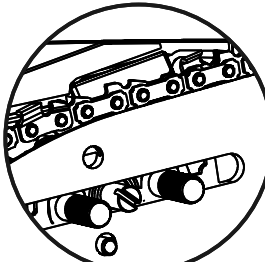
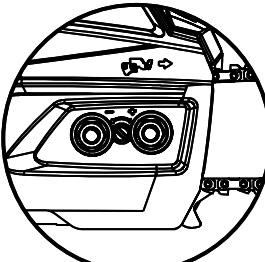
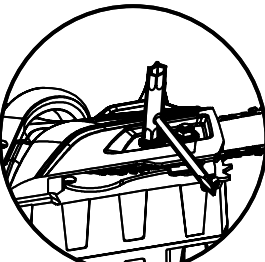
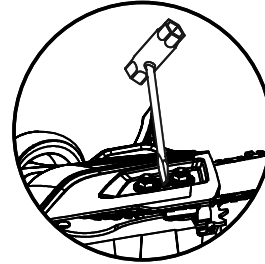
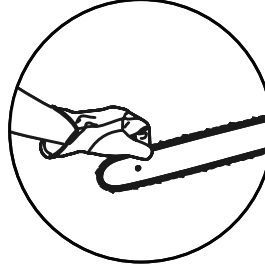
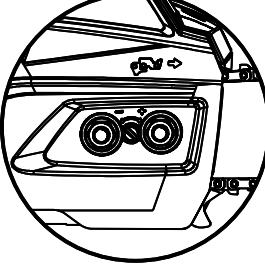
 <p>1. Unscrew the bar nuts from the bar cover by rotating them counterclockwise with the wrench. Remove the bar cover.</p>	 <p>2. Then loosen the adjustment screw 2 or 3 turns.</p>	 <p>3. The bar and chain can now be removed by lifting it away from the main body of the saw. Remove the chain from the sprocket.</p>
 <p>4. The chainsaw can now be cleaned. Remove dust and oil with a brush or rag.</p>	 <p>5. Once the chainsaw is clean, replace the bar and chain. Loop the chain over the sprocket and place the bar against the alignment groove.</p>	 <p>6. Ensure the adjusting block is located in the tensioning hole.</p>
 <p>7. Wipe the oil from the rubber block and bar, which helps keep the tension on the chain.</p>	 <p>8. Replace the bar cover.</p>	 <p>9. Tighten the bar cover by rotating the bar nuts clockwise with the wrench. Do not tighten down the bar nuts all the way. Refer to step 10.</p>
 <p>10. With the bar nuts slightly loosened, turn the chain tensioning screw clockwise to tighten the chain. Once chain is properly tensioned, fully tighten the bar nuts.</p>	 <p>11. There should be enough play that the chain can be pulled away from the bar, but not enough where the runners can be pulled out of the bar.</p>	 <p>12. When the chain is properly adjusted, tighten the bar nuts all the way.</p>

NOTE:

- Chains stretch with use, check and tension often.
- Never tension a warm chain before storing, as chains shrink when cool, this can damage chain, bar and saw.

ENVIRONMENTALLY SAFE BATTERY DISPOSAL

The batteries used in this chainsaw's battery pack contain the following toxic and corrosive material: LITHIUM-ION.

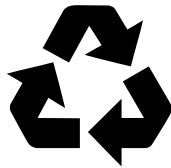

▲ W A R N I N G

Toxic materials must be disposed of in a specific manner in order to prevent contamination of the environment. Before disposing of damaged or worn out Lithium-Ion battery packs, contact your local waste disposal agency or the local Environmental Protection Agency for information and specific instructions. Take the batteries to a local recycling and/or disposal center that is certified for disposal. If the battery pack cracks or breaks, whether it leaks or not, do not recharge it and do not use it. Dispose of it and replace it with a new battery pack.
DO NOT ATTEMPT TO REPAIR IT!

Follow these instructions and to avoid damage to the environment:

- Cover the battery's terminals with heavy-duty adhesive tape.
- Do not attempt to remove or destroy any of the components of the battery pack.
- Do not attempt to open the battery pack.
- If a leak develops, the electrolytes that are released are corrosive and toxic. Do not get the solution in the eyes or on the skin, and do not swallow it.
- Do not place batteries in regular household trash.
- DO NOT incinerate batteries.
- DO NOT place batteries where they will become part of any waste landfill or municipal solid waste stream.
- Dispose of batteries at a certified recycling or disposal center.

TROUBLESHOOTING

PROBLEM	POSSIBLE CAUSE	SOLUTION
Bar and chain running hot and smoking.	Check chain tension for overtightened condition.	Tension chain. Refer to Page 31.
	Chain oil tank empty.	Add bar and chain oil.
Motor runs, but chain is not rotating.	Chain tension too tight.	Refer to Chain Tension Guide earlier in this manual.
	Check guide bar and chain assembly.	Refer to Page 29.
	Check guide bar and chain for damage.	Remove the battery from the unit. Take the bar cover off, and remove the bar and chain. Clean all debris from the chainsaw. After all debris is cleared, insert battery and run the chainsaw. If the sprocket is spinning your motor is okay. If the sprocket is not spinning, call customer service at 1-855-345-3934.
	Chain Brake Is Engaged	Disengage chain break, pull chain break towards yourself.
Motor runs, chain rotates but does not cut.	Dull chain.	Sharpen chain.
	Chain on backwards.	Reverse direction of chain.
Chainsaw does not start.	Battery is not charged.	Place battery into the charger and allow a full charge.
	Switch is defective.	Call our customer service number at 1-855-345-3934 for a service dealer or replacement parts.

LIMITED WARRANTY



GREENWORKS™ hereby warrants this product, to the original purchaser with **proof of purchase**, for a period of four (4) years against defects in materials, parts or workmanship. GREENWORKS™, at its own discretion will repair or replace any and all parts found to be defective, through normal use, free of charge to the customer. This warranty is valid only for units which have been used for personal use that have not been hired or rented for industrial/commercial use, and that have been maintained in accordance with the instructions in the owners' manual supplied with the product from new.

ITEMS NOT COVERED BY WARRANTY:

- 1. Any part that has become inoperative due to misuse, commercial use, abuse, neglect, accident, improper maintenance, or alteration; or
- 2. The unit, if it has not been operated and/or maintained in accordance with the owner's manual; or
- 3. Normal wear, except as noted below;
- 4. Routine maintenance items such as lubricants, blade sharpening;
- 5. Normal deterioration of the exterior finish due to use or exposure.

GREENWORKS HELPLINE:

Warranty service is available by calling our toll-free helpline at **1-855-345-3934**.

TRANSPORTATION CHARGES:

Transportation charges for the movement of any power equipment unit or attachment are the responsibility of the purchaser. It is the purchaser's responsibility to pay transportation charges for any part submitted for replacement under this warranty unless such return is requested in writing by GREENWORKS.

EXPLODED VIEW

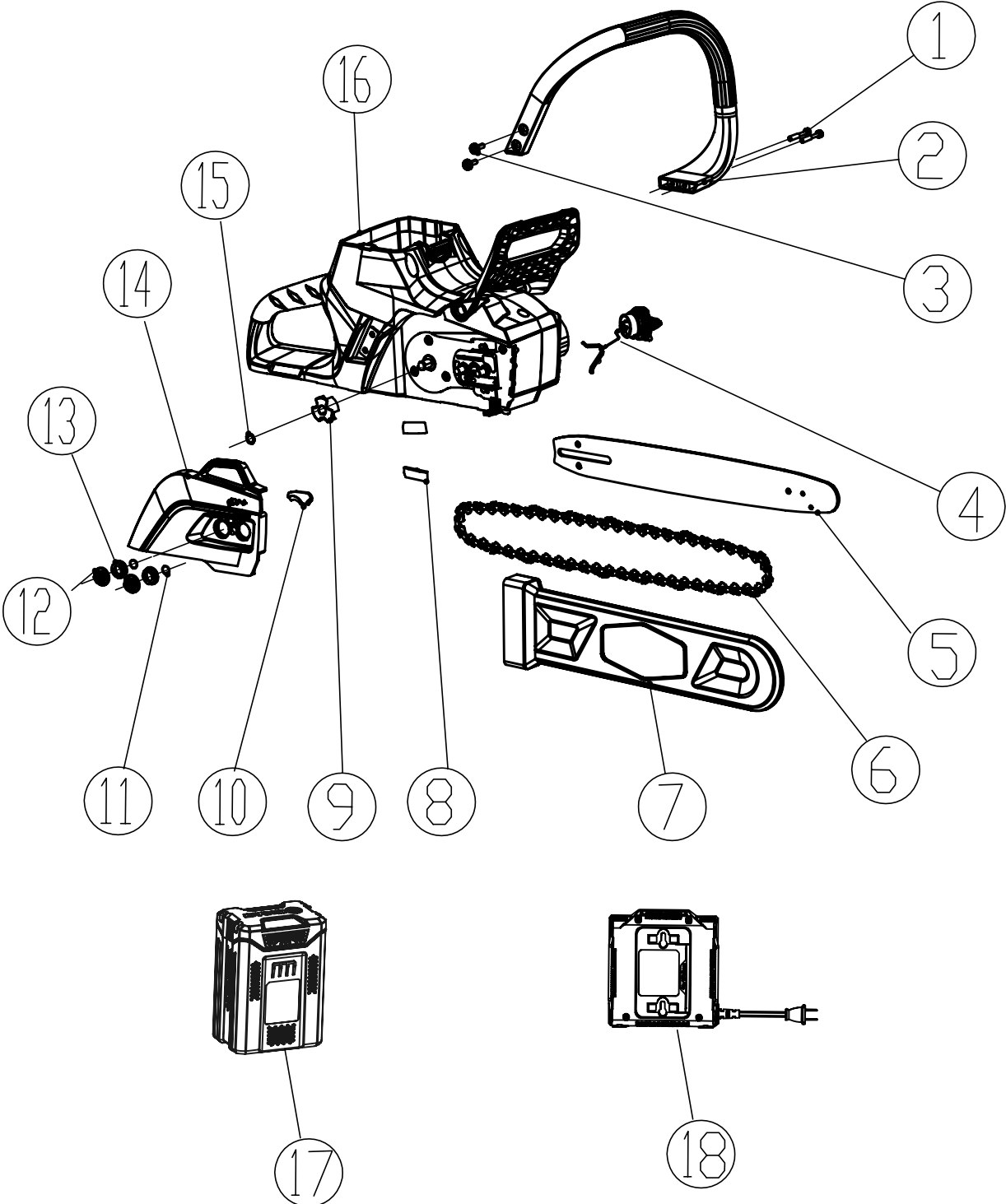

PARTS LIST

ITEM NO.	PART NO.	DESCRIPTION	QTY
1	322021075	T25 ST4.8*90 Screw	2
2	341031900	Auxiliary Handle	1
3	322111884	M6*15 Screw	2
4	311051734B	Oil Tank Knob Assembly	1
5	31201403B	16" Guide Bar	1
6	31202403	16" Chain	1
7	34148590	Scabbard	1
8	341101898	Block Chip	2
9	33902102B	Sprocket	1
10	342011075	Oil Seal Gasket	1
11	329011898	Retainer Clip	2
12	332041898	Bar Nuts	2
13	332031898A	Bushing	2
14	341051900	Bar Cover	1
15	32209590	Collar	1
16	311991900	Chainsaw Assembly	1
17	211011382	Battery (Only for 2002802CT)	1
18	211011989	Charger (Only for 2002802CT)	1



Greenworks Tools
PO Box 1238
 Mooresville, NC 28115

TOLL-FREE HELPLINE: 1-855-345-3934