



Operator's Manual

4500K

Serial Number 4500K-AJ01001 --





500 Venture Drive
Orrville Oh 44667
www.ventrac.com

View all manuals



Visit ventrac.com/manuals for the latest version of this operator's manual.

A downloadable parts manual is also available.

To the Owner Contact Information and Product Identification

If you need to contact an authorized Ventrac dealer for information on servicing your product, always provide the product model and serial numbers.

Please fill in the following information for future reference. See the picture(s) below to find the location of the identification numbers. Record them in the spaces provided.

Date of Purchase: _____

Dealer: _____

Dealer Address: _____

Dealer Phone Number: _____

Dealer Fax Number: _____

<p>Model # (A): _____</p> <p>Serial # (B): _____</p> <p style="text-align: center;">Affix Part/Serial Number label here.</p>
--

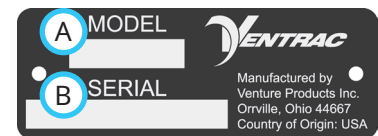

Engine Serial # (C) _____

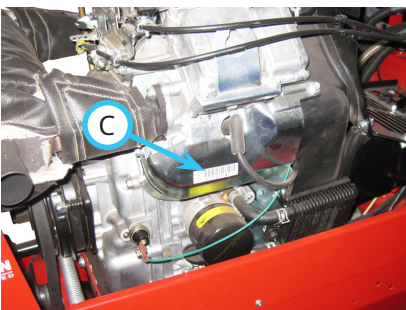

Venture Products Inc. reserves the right to make changes in design or specifications without obligation to make like changes on previously manufactured products.

TABLE OF CONTENTS

INTRODUCTION	PAGE 7
Product Description	7
Why Do I Need an Operator’s Manual?	7
Using Your Manual	8
Manual Glossary	8
SAFETY	PAGE 9
General Safety Procedures	9
Training Required	9
Requirements for Personal Protective Equipment (PPE)	9
Operation Safety.	9
Keep Riders Off	11
Operating On Slopes	11
Roadway Safety	12
Truck Or Trailer Transport	12
Maintenance	12
Fuel Safety	13
Hydraulic Safety	14
Roll Over Protective Structure (ROPS).	15
Operator Access System	15
Operator Safety Interlock System	16
Safety Decals	18
OPERATIONAL CONTROLS	PAGE 22
Operational Control Locations	22
Optional Operational Control Locations	23
Information Cluster Gauge (A).	24
Warning Cluster Gauge (B).	24
Warning Alarm (C).	25
Ignition Switch (D).	25
Throttle Lever (E).	25
Headlight Switch (F).	25
Power Take Off (PTO) Switch (G)	25
Choke Handle (H)	25
Parking Brake (I).	25
Neutral Assist Lever (J)	26
Front Hitch Latch Lever Lock (K)	26
Front Hitch Latch Lever (L)	26
Auxiliary Hydraulic Quick Couplers (M)	26
PTO Belt Tensioner Rod (N).	26
High/Low Shift Lever (O)	27
SDLA Control Lever (P & Q)	27
Steering Wheel (R).	28
Hydraulic Cooler Fan Switch (S)	28
Seat Slide Lever (T).	28
Fuel Shut-off Valve (U).	28
Circuit Breaker & Battery Disconnect (V)	28
Seat Prop Plate (W)	29
Seat Strap Latch (X)	29
Work Light Switch (AA)	29

TABLE OF CONTENTS

OPERATIONAL CONTROLS (Continued)

Strobe Light Switch (BB)	29
Slope Indicator Gauge (CC)	29
Slope Warning Light (DD)	30
Directional Signal Switch (EE)	30
Hazard Flasher Switch (FF)	30
Horn Switch (GG)	30
Weight Transfer Traction Control Select Lever (HH)	30
Front Hitch Valve (II)	30
Foot Pedal (JJ)	31
3 Point Hitch & Rear Auxiliary Control Handles (KK, LL, and MM)	31
Rear Auxiliary Quick Couplers (NN)	32
12 Volt Rear Switches and 4-Pin Socket (OO, PP, and QQ)	32
12 Volt Front Switches and 4-Pin Socket (RR, SS, and TT)	32
Electric PTO Remote Socket (UU)	32
Back Up Alarm (VV)	33
Dual Hydraulic Front Coupler Switch (WW)	33
Seat Slide Lever (XX)	33
Lumbar Support Knob (YY)	33
Backrest Angle Lever (ZZ)	33
Weight Adjustment Lever (BA)	33
Optional Armrest Angle Knob (BC)	33

GENERAL OPERATION

PAGE 34

Daily Inspection	34
Starting the Engine	34
Forward and Reverse	35
Stopping the Power Unit	35
Shutting Off the Engine	35
Attaching	36
Detaching	36
Operating Attachments	36
Front Hitch	36
PTO Drive Belt and Pulley	36
Front Auxiliary Couplers	37
High/Low Range	37
Turning Radius	38
Roll-Over Protection System	38
Weight Transfer	39
3 Point Hitch (Optional Accessory)	39
12 Volt 4-Pin Auxiliary Sockets (Optional Accessory)	39
Directional/Hazard Flasher Operation (Optional Accessory)	40
Optional 70.4111 Suspension Seat Kit Weight Adjustment	40
Operating On Slopes	40
70.4140 Slope Gauge Settings and Operation	41
Audible and Visual Alerts (70.4140 Gauge)	44
70.4140 Slope Gauge Calibration	44
Operation in Water, Mud, Snow, or Ice	44
Towing or Pushing the Power Unit	44

TABLE OF CONTENTS

SERVICE	PAGE 45
Service and General Maintenance	45
Cleaning and Appearance Care	45
Service Access Points	46
Lubrication Locations	46
Checking the Hydraulic Oil Level	47
Checking the Rear Transaxle Oil	48
Changing the Hydraulic Oil Filters	48
Changing the Hydraulic Oil	49
Changing the Rear Transaxle Differential Oil	50
Servicing the Closed Loop Hydrostatic Drive Circuit	51
Servicing the Hydraulic Cooler	51
Checking the Engine RPM	51
Checking the Engine Oil Level	51
Changing the Engine Oil and Filter	52
Changing the Air Filter Elements	53
Filling the Fuel Tank	53
Changing the In-line Fuel Filter	54
Priming the Fuel System	54
Cleaning the Engine Compartment and Engine	54
Servicing the Battery	55
Removing the Battery	55
Installing the Battery	55
Cleaning the Battery and Terminals	56
Charging the Battery	56
Jump Starting Procedure	56
TCM (Tractor Control Module) Explanation	57
Replacing Fuses (Power Relay Module)	57
Replacing Fuses (Front Fuse Panel)	58
Replacing Fuses (Rear Fuse Panel)	58
Switching the Speedometer (mph or km/h)	58
Replacing Light Bulbs (Headlights and Halogen Work Lights)	59
Replacing the Work Lights (LED)	59
Replacing the Taillights	59
Replacing the Turn Signal Lights	59
Replacing the Strobe Light Bulb	59
Replacing the Strobe Light	60
Changing the Strobe Light Flasher Mode	60
PTO Belt Inspection	60
PTO Belt Tension Adjustment	61
PTO Belt Replacement	61
Clutch Air Gap Inspection and Adjustment	62
Wheel Removal and Installation	62
Outer Dual Wheel Removal and Installation	63
Tire Pressure	63
ROPS and Seat Belt Inspection	64
Parking Brake Inspection and Adjustment	64
Neutral Adjustment	65
Neutral Switch Adjustment	66
Storage	67

TABLE OF CONTENTS

SERVICE (Continued)

Maintenance Schedule	69
Maintenance Checklist	70
Maintenance Log	71

TROUBLESHOOTING

PAGE 73

Electrical Troubleshooting Using the Tractor Control Module (TCM)	73
Electrical Troubleshooting Guide	75
Engine.	76
Electrical	77
Hydraulic	78
Engine.	80
Electrical	80
Power Train.	80
Controls and Instrument Panel	80
Other Features.	80
Dimensions.	81
Fluid Capacities and Specifications	81
Amperage Draw Chart	82
Belt Chart.	83

WARRANTY

PAGE 84

INTRODUCTION



Venture Products Inc. is pleased to provide you with your new Ventrac power unit! We hope that Ventrac equipment will provide you with a ONE Tractor Solution.

Please visit our website, or contact your authorized Ventrac dealer for a complete list of items available for your new power unit.

Product Description

The Ventrac 4500 tractor combines all wheel drive and an articulating chassis with a low center of gravity to provide superior traction, braking, stability, and security on tough terrain and slopes without disturbing turf when turning. The attachment is placed out in front in a natural view, offering greater precision, as well as maximum protection for the operator.

Ventrac's patented SDLA control, located next to the operator, allows for easy control of Speed, Direction, Lift, and Auxiliary functions with one hand.

Standard features include:

- a fold down roll bar.
- a computer controlled onboard diagnostic system for the electrical circuits.
- a wiring harness that is pre-wired for optional accessories.
- an electronic instrument panel that includes a tachometer, speedometer, fuel gauge, hour meter, and temperature gauge.
- a six function warning gauge and alarm that includes the engine coolant temperature, hydraulic oil temperature, engine oil temperature, low voltage, low engine oil pressure, and a parking brake indicator.
- a complete electrical system circuit breaker and battery disconnect.
- an automotive pull style parking brake.
- a hydraulic oil cooler with a thermostatically controlled, reversible fan.

Why Do I Need an Operator's Manual?

This manual has been created to help you gain the important knowledge of what is needed to safely operate, maintain, and service your machine. It is divided into sections for convenient reference of the appropriate section.

You must read and understand the operator's manual for each piece of Ventrac equipment you own. Reading the operator's manual will help you become familiar with each specific piece of equipment. Understanding the operator's manual will help you, as well as others, avoid personal injury and/or damage to the equipment. Keep this manual with the machine at all times. The manual should remain with the machine even if it is sold. If this manual becomes damaged or unreadable, it should be replaced immediately. Contact your local Ventrac dealer for a replacement.

When using a Ventrac attachment, be sure to read and follow the safety and operating instructions of both the power unit and the attachment being used to ensure the safest operation possible.

The information in this manual provides the operator with the safest procedures to operate the machine while getting the maximum use out of the unit. Failure to follow the safety precautions listed in this manual may result in personal injury and/or damage to the equipment.

INTRODUCTION

Using Your Manual

Throughout this manual, you will encounter special messages and symbols that identify potential safety concerns to help you as well as others avoid personal injury or damage to the equipment.

SYMBOL DEFINITIONS

ATTENTION



This symbol identifies potential health and safety hazards. It marks safety precautions. Your safety and the safety of others is involved.

There are three signal words that describe the level of safety concern: Danger, Warning, and Caution. Safety should always be the first priority when working on or operating equipment. Accidents are more likely to occur when proper operating procedures are not followed or inexperienced operators are involved.

Note: Right-Hand and Left-Hand orientations may be referred to at different places throughout this manual. Right-Hand and Left-Hand is determined as if facing forward from the operator station.

SIGNAL WORD DEFINITIONS

⚠ DANGER

Indicates an imminently hazardous situation which, if not avoided, will result in death or serious injury. This signal word is limited to the most extreme cases.

⚠ WARNING

Indicates a potentially hazardous situation which, if not avoided, could result in death or serious injury.

⚠ CAUTION

Indicates a potentially hazardous situation which, if not avoided, may result in minor or moderate injury and/or property damage. It may also be used to alert against unsafe practices.

Manual Glossary

- Power Unit** A Ventrac tractor or other Ventrac engine powered device that may be operated by itself or with an attachment or accessory.
- Attachment** A piece of Ventrac equipment that requires a Power Unit for operation.
- Accessory** A device that attaches to a Power Unit or Attachment to extend its capabilities.
- Machine** Describes any "Attachment" or "Accessory" that is used in conjunction with a power unit.

SAFETY



General Safety Procedures for Ventrac Power Units, Attachments, & Accessories



Training Required

- The owner of this machine is solely responsible for properly training the operators.
- The owner/operator is solely responsible for the operation of this machine and for the prevention of accidents or injuries occurring to him/herself, other people, or property.
- Do not allow operation or service by children or untrained personnel. Local regulations may restrict the age of the operator.
- Before operating this machine, read the operator's manual and understand its contents.
- If the operator of the machine cannot understand this manual, then it is the responsibility of this machine's owner to fully explain the material within this manual to the operator.
- Learn and understand the use of all the controls.
- Know how to stop the power unit and the attachments quickly in the event of an emergency.

Requirements for Personal Protective Equipment (PPE)

- The owner is responsible for ensuring that all the operators use the proper PPE while operating the machine. Whenever you use the machine, use the following PPE:
- Certified eye protection and hearing protection.
- Closed toe, slip resistant footwear.
- Long pants or trousers.
- A dust mask for dusty conditions.

Operation Safety

- Inspect the machine before operation. Repair or replace any damaged, worn, or missing parts. Be sure the guards and shields are in proper working condition and are secured in place. Make any necessary adjustments before operating the machine.
- Some pictures in this manual may show shields or covers opened or removed in order to clearly illustrate the instructions. Under no circumstance should the machine be operated without these devices in place.
- Alterations or modifications to this machine can reduce safety and could cause damage to the machine. Do not alter the safety devices or operate with the shields or covers removed.
- Before each use, verify that all the controls function properly and inspect all the safety devices. Do not operate if the controls or safety devices are not in proper working condition.
- Check the parking brake function before operating. Repair or adjust the parking brake if necessary.
- Observe and follow all of the safety decals.
- All the controls are to be operated from the operator's station only.

SAFETY



General Safety Procedures for Ventrac Power Units, Attachments, & Accessories



- Always wear a seat belt if the machine has a roll cage/bar installed and in the upright position.
- Ensure the attachment or accessory is locked or fastened securely to the power unit before operating.
- Ensure that all bystanders are clear of the power unit and the attachment before operating. Stop the machine if someone enters your work area.
- Always be alert to what is happening around you, but do not lose focus on the task you are performing. Always look in the direction the machine is moving.
- Look behind and down before backing up to be sure of a clear path.
- If you hit an object, stop and inspect the machine. Make any necessary repairs before operating the machine again.
- Stop operation immediately at any sign of equipment failure. An unusual noise can be a warning of equipment failure or a sign that maintenance is required. Make any necessary repairs before operating the machine again.
- If equipped with a high/low range feature, never shift between high and low range while on a slope. Always move the machine to level ground and engage the parking brake before shifting range.
- Do not leave the machine unattended while it is running.
- Always park the machine on level ground.
- Always shut off the engine when connecting the attachment drive belt to the power unit.
- Never leave the operator's station without lowering the attachment to the ground, engaging the parking brake, shutting off the engine, and removing the ignition key. Make sure all moving parts have come to a complete stop before dismounting.
- Never leave the machine unattended without lowering the attachment to the ground, engaging the parking brake, shutting off the engine, and removing the ignition key.
- Only operate in well-lit conditions.
- Do not operate when there is a risk of lightning.
- Never direct the discharge of any attachment in the direction of people, buildings, animals, vehicles, or other objects of value.
- Never discharge material against a wall or obstruction. The material may ricochet back toward the operator.
- Use extra caution when approaching blind corners, shrubs, trees, or other objects that may obscure your vision.
- Do not run the engine in a building without adequate ventilation.
- Do not touch the engine or the muffler while the engine is running or immediately after stopping the engine. These areas may be hot enough to cause a burn.
- Do not change the engine governor settings or over-speed the engine. Operating the engine at excessive speeds may increase the hazard of personal injury.

SAFETY



General Safety Procedures for Ventrac Power Units, Attachments, & Accessories



- To reduce the hazard of fire, keep the battery compartment, engine, and muffler areas free of grass, leaves, excessive grease, and other flammable materials.
- Secure long hair and loose clothing. Do not wear jewelry.
- Clear the working area of objects that might be hit or thrown from the machine.
- Keep people and pets out of the working area.
- Know the work area well before operation. Do not operate where traction or stability is questionable.
- Reduce speed when you are operating over rough ground.
- Equipment can cause serious injury and/or death when improperly used. Before operating, know and understand the operation and safety of the power unit and the attachment being used.
- Do not operate the machine if you are not in good physical and mental health, if you will be distracted by personal devices, or if you are under the influence of any substance which might impair your decisions, dexterity, or judgment.
- Children are attracted to machine activity. Be aware of children and do not allow them in the work area. Turn off the machine if a child enters the work area.

Keep Riders Off

- Only allow the operator on the power unit. Keep riders off.
- Never allow riders on any attachment or accessory.

Operating On Slopes

- Slopes can cause loss-of-control and tip-over accidents, which can result in severe injury or death. Be familiar with the emergency parking brake, along with the power unit controls and their functions.
- If the power unit is equipped with a fold down roll bar, it must be locked in the upright position when operating on any slope.
- Use low range (if equipped) when operating on slopes greater than 15 degrees.
- Do not stop or start suddenly when operating on slopes.
- Never shift between high and low range while on a slope. Always move the power unit to level ground and engage the parking brake before shifting range or placing the power unit in neutral.
- Variables such as wet surfaces and loose ground will reduce the degree of safety. Do not drive where the machine could lose traction or tip over.
- Keep alert for hidden hazards in the terrain.
- Stay away from drop-offs, ditches, and embankments.
- Sharp turns should be avoided when operating on slopes.

SAFETY



General Safety Procedures for Ventrac Power Units, Attachments, & Accessories



- Pulling loads on hills decreases safety. It is the responsibility of the owner/operator to determine loads that can safely be controlled on slopes.
- Transport the machine with the attachment lowered or close to the ground to improve stability.
- While operating on slopes, drive in an up and down direction whenever possible. If turning is necessary while driving across slopes, reduce your speed and turn slowly in the downhill direction.
- Ensure a sufficient supply of fuel for continuous operation. A minimum of one-half tank of fuel is recommended.

Roadway Safety

- Operate with safety lights when operating on or near roadways.
- Obey all state and local laws concerning operation on roadways.
- Slow down and be careful of traffic when operating near or crossing roadways. Stop before crossing roads or sidewalks. Use care when approaching areas or objects that may obscure vision.
- If there is any doubt of safety conditions, discontinue the machine operation until a time when the operation can be performed safely.
- When operating near or on roadways, have a Slow Moving Vehicle Emblem clearly displayed.

Truck Or Trailer Transport

- Use care when loading or unloading the machine into a truck or trailer.
- Use full width ramps for loading the machine into a truck or trailer.
- The parking brake is not sufficient to lock the machine during transport. Always secure the power unit and/or attachment to the transporting vehicle securely using straps, chains, cables, or ropes. Both the front and rear straps should be directed down and outward from the machine.
- Shut off the fuel supply to the power unit during transport on a truck or trailer.
- If equipped, turn the battery disconnect switch to the Off position to shut off electrical power.

Maintenance

- Keep the safety decals legible. Remove all grease, dirt, and debris from the safety decals and instructional labels.
- If any decals are faded, illegible, or missing, contact your dealer promptly for replacements.
- When new components are installed, be sure that the current safety decals are affixed to the replacement components.
- If any component requires replacement, use only original Ventrac replacement parts.
- Always turn the battery disconnect to the Off position or disconnect the battery before performing any repairs. Disconnect the negative terminal first and the positive terminal last. Reconnect the positive terminal first and the negative terminal last.

SAFETY



General Safety Procedures for Ventrac Power Units, Attachments, & Accessories



- Keep all bolts, nuts, screws, and other fasteners properly tightened.
- Always lower the attachment to the ground, engage the parking brake, shut off the engine, and remove the ignition key. Make sure all moving parts have come to a complete stop before cleaning, inspecting, adjusting, or repairing.
- If the power unit, attachment, or accessory requires repairs or adjustments not instructed in the operator's manual, the power unit, attachment, or accessory must be taken to an authorized Ventrac dealer for service.
- Never perform maintenance on the power unit and/or attachment if someone is in the operator's station.
- Always use protective glasses when handling the battery.
- Check the fuel lines for tightness and wear on a regular basis. Tighten or repair them as needed.
- To reduce the hazard of fire, keep the battery compartment, engine, and muffler areas free of grass, leaves, and excess grease.
- Do not touch the engine, the muffler, or other exhaust components while the engine is running or immediately after stopping the engine. These areas may be hot enough to cause a burn.
- Allow the engine to cool before storing and do not store near an open flame.
- Do not change the engine governor settings or over-speed the engine. Operating engine at excessive speeds may increase the hazard of personal injury.
- Springs may contain stored energy. Use caution when disengaging or removing springs and/or spring loaded components.
- An obstruction or blockage in a drive system or moving/rotating parts may cause a buildup of stored energy. When the obstruction or blockage is removed, the drive system or moving/rotating parts may move suddenly. Do not attempt to remove an obstruction or blockage with your hands. Keep your hands, feet, and clothing away from all power-driven parts.

Fuel Safety

- To avoid personal injury or property damage, use extreme care in handling gasoline. Gasoline is extremely flammable and the vapors are explosive.
- Do not refuel the machine while smoking or at a location near flames or sparks.
- Always refuel the machine outdoors.
- Do not store the machine or fuel container indoors where the fumes or fuel can reach an open flame, spark, or pilot light.
- Only store fuel in an approved container. Keep out of the reach of children.
- Never fill containers inside a vehicle or on a truck or trailer bed with a plastic liner. Always place the containers on the ground away from your vehicle before filling.

SAFETY



General Safety Procedures for Ventrac Power Units, Attachments, & Accessories



- Remove the machine from the truck or trailer and refuel it on the ground. If this is not possible, refuel the machine using a portable container, rather than from a fuel dispenser nozzle.
- Never remove the fuel cap or add fuel with the engine running. Allow the engine to cool before refueling.
- Never remove the fuel cap while on a slope. Only remove the fuel cap when parked on a level surface.
- Replace the fuel tank cap and the container cap securely.
- Do not overfill the fuel tank. Only fill to the bottom of the fuel neck, do not fill the fuel neck full. Overfilling of the fuel tank could result in engine flooding, fuel leakage from the tank, and/or damage to the emissions control system.
- If fuel is spilled, do not attempt to start the engine. Move the power unit away from the fuel spill and avoid creating any source of ignition until the fuel vapors have dissipated.
- If the fuel tank must be drained, it should be drained outdoors into an approved container.
- Check the fuel lines for tightness and wear on a regular basis. Tighten or repair them as needed.
- The fuel system is equipped with a shut-off valve. Shut off the fuel when transporting the machine to and from the job, when parking the machine indoors, or when servicing the fuel system.

Hydraulic Safety

- Make sure the hydraulic connections are tight and all hydraulic hoses and tubes are in good condition. Repair any leaks and replace any damaged or deteriorated hoses or tubes before starting the machine.
- Hydraulic leaks can occur under high pressure. Hydraulic leaks require special care and attention.
- Use a piece of cardboard and a magnifying glass to locate suspected hydraulic leaks.
- Keep your body and hands away from pinhole leaks or nozzles that eject high pressure hydraulic fluid. Hydraulic fluid escaping under high pressure can penetrate the skin causing serious injury, leading to severe complications and/or secondary infections if left untreated. If hydraulic fluid is injected into the skin, seek immediate medical attention no matter how minor the injury appears.
- The hydraulic system may contain stored energy. Before performing maintenance or repairs on the hydraulic system, remove any attachments, engage the parking brake, disengage the weight transfer system (if equipped), shut off the engine, and remove the ignition key. To relieve pressure on the auxiliary hydraulic system, shut off the power unit engine and move the hydraulic control lever left and right before disconnecting the auxiliary hydraulic quick couplers.

SAFETY



4500 Safety Procedures



- The weight transfer spring may contain stored energy. Always disengage the weight transfer system (if equipped) before performing maintenance or repairs on the weight transfer system, the front hitch, or the lift hydraulics.

Roll Over Protective Structure (ROPS)

WARNING

Keep the ROPS locked in the upright position and the seat belt securely fastened during operation. Failure to do so could result in serious injury or loss of life.

WARNING

Alterations or modifications to this machine and/or the ROPS structure can reduce safety and could cause damage to the machine. Do not alter the ROPS. Do not alter any other safety devices.

Your power unit is equipped with a Roll Over Protective Structure (ROPS). This ROPS was tested and certified in accordance with the following standards.

ROPS: SAE J1194 and OSHA 1928.51 = maximum GVW of 1,818 kg (4,000 pounds).

ISO 21299 = maximum GVW of 1,329 kg (2,930 pounds).

Seat Belt Anchorage: ISO 3776-2, ISO 3776-3, ISO 6683, & SAE J386

- The ROPS certification applies only when the roll bar is locked in the upright position. Be aware that there is no rollover protection when a folding ROPS is in the down position.
- DO NOT remove the ROPS. Alterations to the ROPS structure are not permitted.
- Lower the roll bar only when absolutely necessary and raise the roll bar to the upright position as soon as clearance allows. Never lower a folding ROPS in areas where there are slopes, drop offs, or water.
- Check carefully for overhead clearances (i.e. branches, doorways, electrical wires) before driving under any objects and do not contact them.
- Always wear the seat belt when the roll bar is locked in the upright position. Be certain the seat belt can be released quickly in the event of an emergency.
- Do not wear a seat belt when the roll bar has been lowered to the down position.
- If any part of this ROPS experiences structural damage, the entire ROPS must be replaced.
- Inspect the seat belt for wear or damage before use. Failure to inspect or maintain the seat belt can cause injury or loss of life.

Operator Access System

- The operator access system is on the left side of the power unit. Mount and dismount the 4500 power unit only from the left side.

SAFETY

Operator Safety Interlock System

The 4500 power unit is equipped with a safety interlock system. This system:

- Prevents the engine from starting unless the parking brake is engaged and the SDLA control is in neutral.
- Prevents the PTO from starting if the operator is not in the seat.
- Prevents the power unit from driving if the parking brake is engaged.*
- Shuts off the PTO if the operator leaves the seat.^
- Shuts off the engine (and fuel pump) if the operator leaves the seat without engaging the parking brake.
- Shuts off the engine if the forward / reverse controls (SDLA lever or foot pedal) are moved from neutral while the parking brake is engaged.

* The parking brake must be completely disengaged before moving the SDLA lever forward or backward or the power unit engine will shut off.

^If the power unit is equipped with a PTO remote kit and is using an attachment with a remote PTO shut-off switch, the safety interlock system performs additional functions.

Testing the Safety Interlock System

⚠ WARNING

Never operate the power unit if the safety interlock system is malfunctioning. Do not disengage or bypass any switch. Failure to heed this warning could result in injury to yourself or others, or damage to property.

⚠ WARNING

The parking brake must be disengaged during portions of the safety interlock system test. Place wheel chocks in front and back of the wheels to prevent the power unit from moving.

⚠ CAUTION

The daily inspection should be performed prior to initial startup for the day.

Perform the following safety interlock tests daily to test the electrical portion of the interlock system. Before testing, park the power unit on a level surface, place wheel chocks in front and back of the wheels, and place the high/low range shift lever in the neutral position. After testing is complete, place the high/low shift lever in either high or low range, engage the parking brake, and remove the wheel chocks.

Tests 1-4 test the 'Engine Start' function. For each test, turn the ignition key to the RUN position (do not start the engine). As listed for each test, engage or disengage the parking brake*, place the SDLA in neutral or out of neutral^, and sit on the seat or raise your body weight from the seat. The engine starter should or should not engage as described for each test.

	Test Number	Parking Brake* Engaged	Forward/Reverse Control (SDLA) in Neutral^	Operator Present in Seat	Engine Starts
Engine Start	1	No	Yes	Yes	No
	2	Yes	No	Yes	No
	3	Yes	Yes	No	Yes
	4	Yes	Yes	Yes	Yes

*This tests the function of the parking brake switch. The parking brake handle should be engaged the minimum amount necessary to activate the parking brake indicator light on the warning gauge.

^This tests the function of the neutral switch located on the hydraulic pump. Depending on settings and the age of the power unit, the range for neutral for the SDLA control may vary. For this test, the SDLA lever should move 2.5 cm (1 inch) or less forward or backward for neutral switch activation (measured at the top of the lever).

SAFETY

Testing the Safety Interlock System (continued)

Tests 5-9 test the 'Engine Run' function. For each test, start the power unit so that the engine is running. As listed for each test, engage or disengage the parking brake*, place the SDLA in neutral or out of neutral^, and sit on the seat or raise your body weight from the seat. The engine should continue running or stop running as described for each test.

	Test Number	Parking Brake* Engaged	Forward/Reverse Control (SDLA) in Neutral^	Operator Present in Seat	Engine Runs
Engine Run	5	Yes	Yes	Yes	Yes
	6	Yes	Yes	No	Yes
	7	Yes	No	No	No
	8	Yes	No	Yes	No
	9	No	Yes	No	No

Tests 10-13 test the 'PTO' function. For each test, turn the ignition key to the RUN position (do not start the engine). As listed for each test, place the PTO switch in the On or OFF position and sit on the seat or raise your body weight from the seat. The electric PTO clutch will make an audible noise when it engages or disengages.

	Test Number	PTO Switch	Operator Present in Seat	PTO Clutch
PTO	10	Off	Yes	Off
	11	Pull to 'On' Position	No	No
	12	Pull to 'On' Position	Yes	Yes
	13	On	Raise Operator Body Weight from Seat	PTO Disengages (1/2 second delay)

If the power unit fails any one of the safety interlock tests, refer to the troubleshooting section for using the TCM (tractor control module) to diagnose electrical problems.

*This tests the function of the parking brake switch. The parking brake handle should be engaged the minimum amount necessary to activate the parking brake indicator light on the warning gauge. Neutral assist must be off.

^This tests the function of the neutral switch located on the hydraulic pump. Depending on settings and the age of the power unit, the range for neutral for the SDLA control may vary. For this test, the SDLA lever should move 2.5 cm (1 inch) or less forward or backward for neutral switch activation (measured at the top of the lever).

SAFETY

Safety Decals

The following safety decals must be maintained on your attachment.

Keep all safety decals legible. Remove all grease, dirt, and debris from safety decals and instructional labels. If any decals are faded, illegible, or missing, contact your dealer promptly for replacements.

When new components are installed, be sure that current safety decals are affixed to the replacement components.

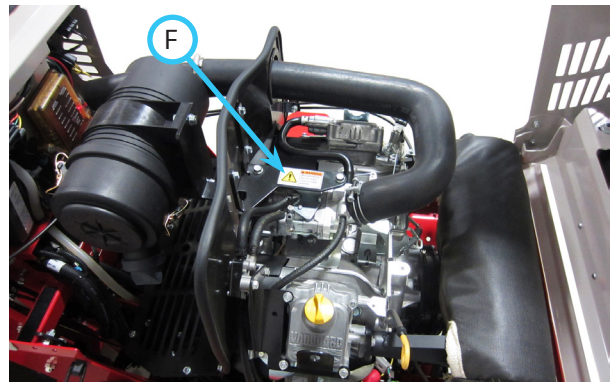
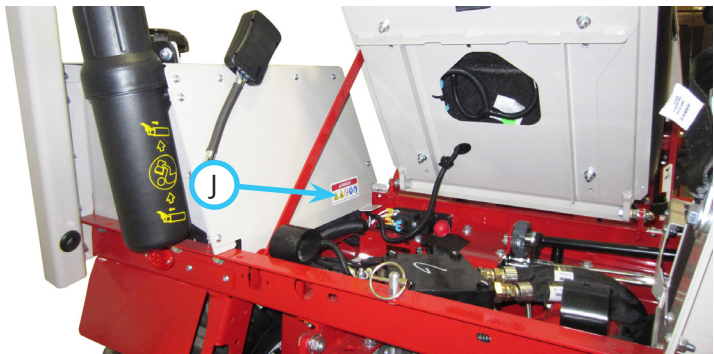

SAFETY



1. Warning - Read operator's manual.
2. Rollover hazard - Roll bar must be in the raised and locked position when operating on slopes.
3. Always wear a seat belt when operating with the roll bar in the upright position. Do not wear a seat belt when operating with the roll bar in the lowered position.



1. Warning - Explosion/fire hazard.
2. Keep away from fire, sparks, and pilot lights when refueling or storing machine and fuel.
3. Smoking is prohibited.
3. Use unleaded gasoline only with an ethanol content of 10 percent or less.

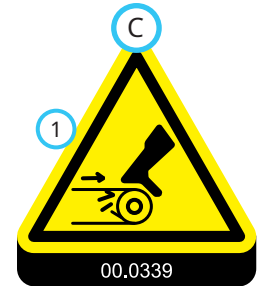

1. Cutting/entanglement hazard - Stay away from moving parts.



1. Operators must receive training prior to operating the machine.
2. Do not operate with shields or guards removed.
3. Wear personal protective gear, such as safety glasses, closed toe shoes or boots, and ear protection.
4. Do not operate while under the influence of drugs or alcohol.
5. Do not carry passengers. Stop the machine if someone enters the area.
6. WARNING: Stay away from the edge of drop-offs, ditches, and embankments. The machine could roll over if a wheel drops over the edge or if the edge caves in.
7. WARNING: Read slope operation instructions. Use low range when operating on slopes. Keep the roll bar in the raised and locked position and the seat belt securely fastened.
8. Only lower the roll bar if there is low overhead clearance. DO NOT wear a seat belt when operating with the roll bar in the lowered position. As soon as there is clearance, raise the roll bar to the upright position and lock it in place. ALWAYS wear a seat belt when operating with the roll bar in the raised position.
9. WARNING: Hydraulic fluid is under high pressure and can penetrate skin, causing injury. Keep hands, face, and body away from pinholes or nozzles that eject hydraulic fluid under high pressure.
10. When towing or pushing the power unit, the transaxles must be disengaged by moving the high/low range shift handle to the neutral position or damage to the hydraulic system will result.

SAFETY



1. Pinching or crushing hazard - foot. Stay away from moving parts.

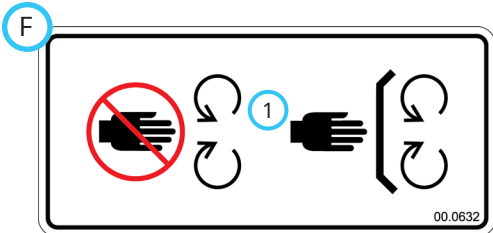

1. Stay away from moving parts. Keep all guards and shields in place.

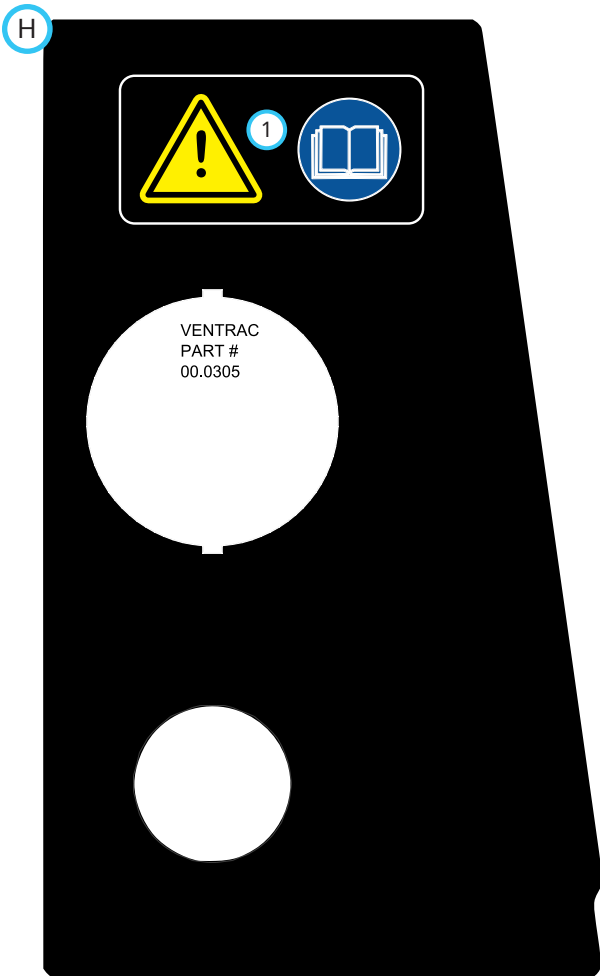

1. Warning - Read the operator's manual.

00.0642

	A	B	C
9	55-110 kPa (8-16 psi)	55-69 kPa (8-10 psi)	41-55 kPa (6-8 psi)
10	55-110 kPa (8-16 psi)	55-69 kPa (8-10 psi)	41-55 kPa (6-8 psi)
11	103-138 kPa (15-20 psi)	103-117 kPa (15-17 psi)	69-83 kPa (10-12 psi)

- Warning - 20 degree maximum slope rating when equipped with single wheels.
- Warning - 25 degree maximum slope rating when equipped with 7.6 cm (3 inch) wheel extensions.
- Warning - 30 degree maximum slope rating when equipped with dual wheels.
- Slope rating may be reduced when adding a cab and other accessories or attachments. Read the operator's manual for the cab, accessory, or attachment being used.
- Reduce speed on slopes, especially when turning. Avoid sharp turns when operating on slopes.
- Use low range when operating on slopes. Do not shift between high and low range on a slope.
- Torque the wheel lug nuts to 75 Nm (55 ft-lbs).
- Torque the dual wheel hub draw bolts to 163 Nm (120 ft-lbs).
- Inflate All Terrain tires to the pressure range indicated for single wheels and the inner and outer dual wheels.
- Inflate Bar tires to the pressure range indicated for single wheels and the inner and outer dual wheels.
- Inflate Turf tires to the pressure range indicated for single wheels and the inner and outer dual wheels.

SAFETY



1. Caustic liquid/chemical burns hazard.
2. Explosion hazard - batteries produce flammable and explosive gases.
3. Do not expose the battery to arcs, sparks, or open flame. Do not smoke near batteries.
4. Keep bystanders away from the battery.
5. Wear eye protection, such as goggles or a face shield, when checking or servicing batteries.
6. Wear protective gear, such as rubber gloves and an apron, when checking or servicing batteries.



1. Cutting or pinching hazard. Stay away from moving parts.

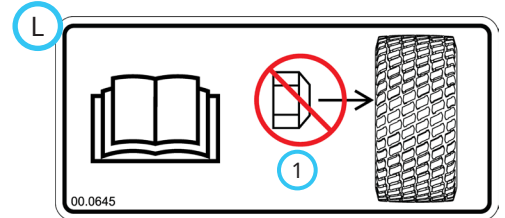

1. Place this side of the rim against the axle hub. Do not install the wheel lug nuts on this side of the rim. Refer to the operator's manual.

Decal	Description	Part Number	Quantity
A	ROPS 4500 Certification	00.0644	1
B	Gasoline Safety	00.0457	1
C	Moving Parts	00.0339	1
D	4500 Safety	00.0336	1
E	Pinching Hazard Foot	00.0639	2
F	Moving Parts Hazard	00.0632	1
G	Slope Warning	00.0642	1
H	Right Dash	00.0305	1
J	Battery Hazard	00.0629	1
K	Pinch Point Hazard (optional kit)	00.0364	2
L	Hub Side	00.0645	4

OPERATIONAL CONTROLS

Operational Control Locations

Become familiar with all the controls before you start the engine and operate the machine.

- A. Information Cluster Gauge
- B. Warning Cluster Gauge
- C. Warning Alarm (Continuous)
- D. Ignition Switch
- E. Throttle Lever
- F. Headlight Switch
- G. PTO Switch
- H. Choke Handle
- I. Parking Brake
- J. Neutral Assist Lever
- K. Front Hitch Latch Lever Lock
- L. Front Hitch Latch Lever

- M. Auxiliary Hydraulic Quick Couplers
- N. PTO Belt Tensioner Rod
- O. High/Low Shift Lever
- P. Primary SDLA Control Lever
- Q. Secondary SDLA Control Lever
- R. Steering Wheel
- S. Hydraulic Cooler Fan Switch
- T. Seat Slide Lever
- U. Fuel Shut-off Valve
- V. Circuit Breaker and Battery Disconnect
- W. Seat Prop Plate
- X. Seat Latch Strap

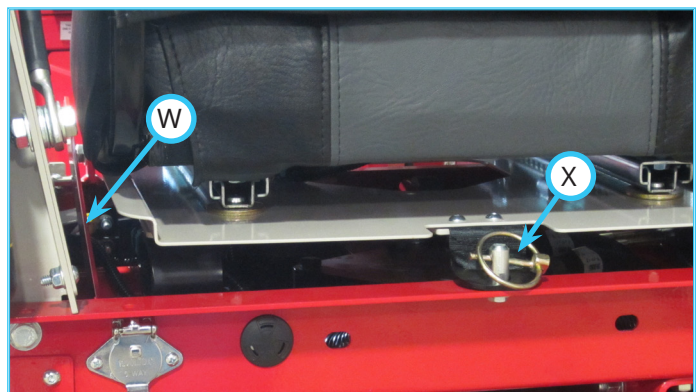
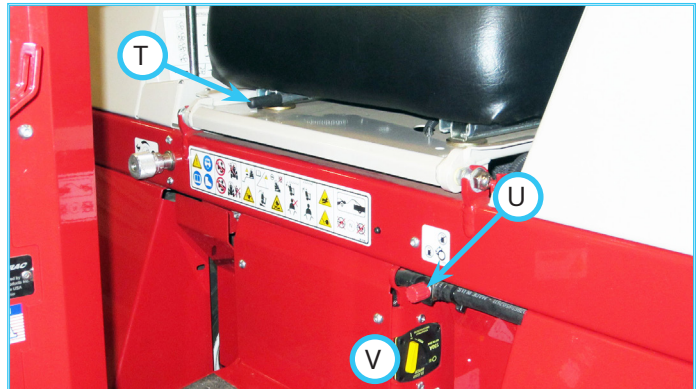
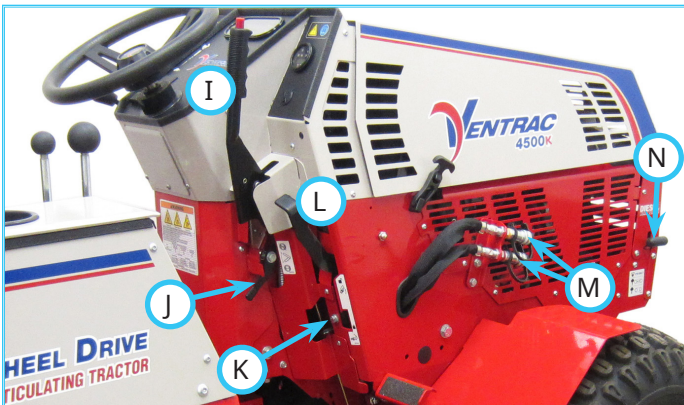
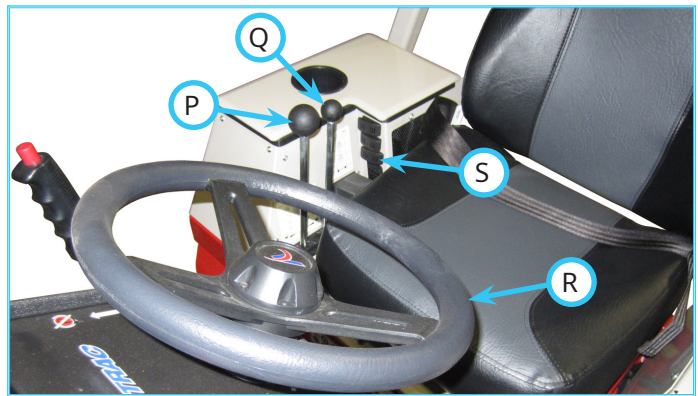

OPERATIONAL CONTROLS

Optional Operational Control Locations

Become familiar with the controls for any optional accessories with which your power unit is equipped.

- AA. Work Light Switch
- BB. Strobe Light Switch
- CC. Slope Indicator Gauge
- DD. Slope Warning Light
- EE. Directional Signal Switch
- FF. Hazard Flasher Switch
- GG. Horn Switch
- HH. Weight Transfer Select Lever
- II. Front Hitch Valve
- JJ. Foot Pedal
- KK. 3 Point Hitch Control Handle
- LL. Left Rear Auxiliary Hydraulics Handle

- MM. Right Rear Auxiliary Hydraulics Handle
- NN. Rear Auxiliary Hydraulic Quick Couplers
- OO. Rear 12V Switch (On/Off)
- PP. Rear 12V Switch (Momentary On/Off/On)
- QQ. Rear 12V 4-Pin Socket
- RR. Front 12V Switch (On/Off)
- SS. Front 12V Switch (Momentary On/Off/On)
- TT. Front 12V 4-Pin Socket
- UU. Electric PTO Remote Socket
- VV. Back Up Alarm
- WW. Dual Hydraulic Front Coupler Switch
- XX. Seat Slide Lever
- YY. Lumbar Support Knob
- ZZ. Backrest Angle Lever
- BA. Weight Adjustment Lever
- BC. Optional Armrest Angle Knob

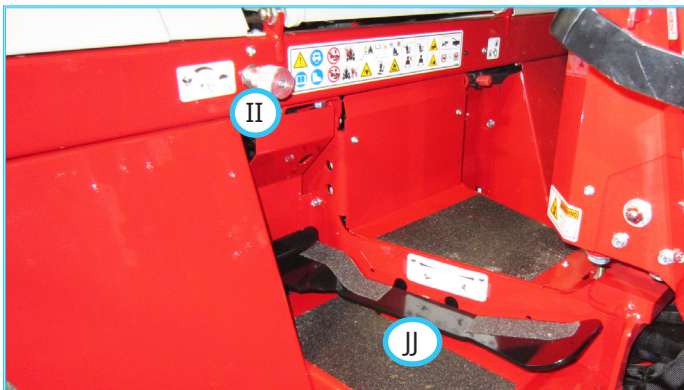
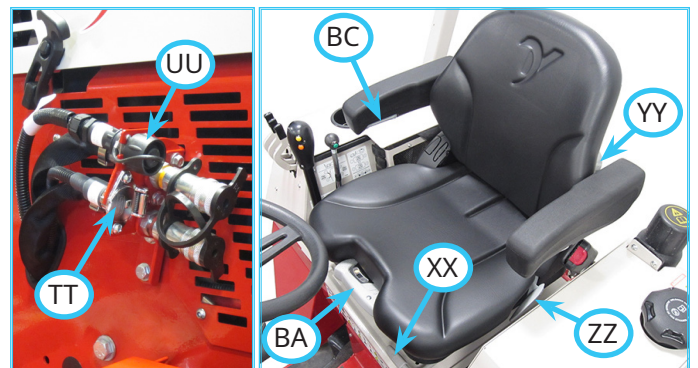
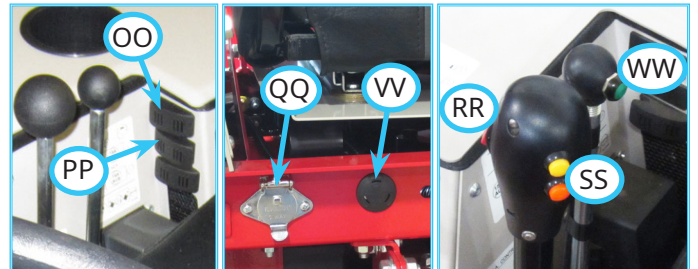
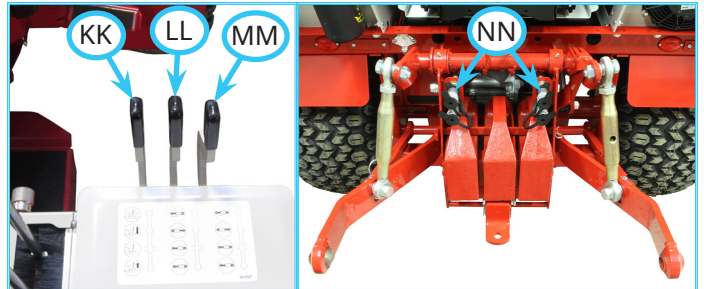

OPERATIONAL CONTROLS

Information Cluster Gauge (A)



1. Tachometer
2. Speedometer
3. Hour Meter
4. Water Temperature Gauge
5. Fuel Gauge
6. Glow Plug Indicator Light

The information cluster gauge contains a tachometer, speedometer, hour meter, water temperature gauge, fuel gauge, and glow plug indicator light.

The **tachometer** displays the engine speed in RPM.

The **speedometer** displays the speed of the power unit. The speedometer can be set to display either miles per hour (mph) or kilometers per hour (km/h).

The **hour meter** records the accumulated time the ignition key has been switched to the On position.

The **water temperature gauge** displays the temperature of the engine cooling system.

The **fuel gauge** displays the level of fuel in the tank.

The **glow plug indicator light** indicates activation of the glow plugs for preheating the engine. The glow plugs activate when the key is turned to the On position. When the glow plug light turns off, the engine is ready to start.

Warning Cluster Gauge (B)



1. Volt Meter
2. Parking Brake Indicator Light
3. Engine Oil Low Pressure Warning Light
4. Water High Temperature Warning Light
5. Hydraulic Fluid High Temperature Warning Light
6. Low Voltage Warning Light

The warning cluster gauge contains a volt meter, a parking brake indicator light, an engine oil low pressure warning light, a water high temperature warning light, a hydraulic fluid high temperature warning light, and a low voltage warning light.

The **volt meter** displays the voltage level of the charging system.

The **parking brake indicator light** activates when the parking brake is engaged.

The **engine oil low pressure warning light** activates when the engine oil pressure is below safe levels. The light comes on when the ignition key is switched to the On position and stays illuminated until the engine is started and safe oil pressure develops. If this light comes on during operation, shut off the engine immediately. Do not restart the engine until the problem has been located and corrected.

The **water high temperature warning light** activates when the temperature of the engine cooling system reaches unsafe levels. If this light comes on during operation, park the power unit, turn the PTO off, move the throttle lever to the low idle position, and allow the engine to cool. Check the radiator screen and clean, if necessary. If the engine temperature continues to rise, shut off the engine. If the engine continually overheats, refer to the troubleshooting section for possible problems.

The **hydraulic fluid high temperature warning light** activates when the hydraulic fluid temperature reaches unsafe levels. If this light comes on during operation, park the power unit and move the throttle lever to the low idle position. Check the hydraulic cooling fan to ensure it is operating properly and refer to the troubleshooting section for possible problems.

The **low voltage warning light** activates when the voltage drops to unacceptable levels. If this light comes on, shut off any unnecessary lights and accessories to reduce the current draw. If the voltage continues to drop, park the power unit, shut off the engine, and turn the ignition key to the Off position. Refer to the troubleshooting section for possible problems.

OPERATIONAL CONTROLS

Warning Alarm (C)

The warning alarm works with the warning cluster gauge to alert the operator to problems. The warning alarm sounds a continuous signal whenever a warning is displayed on the warning cluster gauge. If the warning alarm sounds, immediately check the warning cluster gauge to determine the cause of the warning and then take appropriate action.

Ignition Switch (D)

1. Off or Stop Position - all 12 volt power going through the ignition switch is off.
2. On or Run Position - engine run position, 12 volt power is sent to accessories.
3. Start Position - when the key is turned to the start position, the starter will engage.

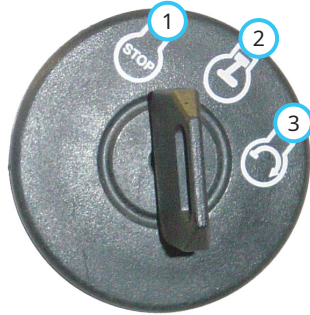

Throttle Lever (E)

Moving the throttle lever forward toward the fast position (1) increases the engine Revolutions Per Minute (RPM). Moving the throttle lever backward toward the slow position (2) decreases the engine RPM.



Headlight Switch (F)

Press the top (1) of the headlight switch to turn on the headlights and taillights. Press the bottom (2) of the switch to turn the lights off.



Power Take Off (PTO) Switch (G)

Pull the PTO switch up to the On position (2) to engage the electric clutch and send power to the front attachment.

Push the PTO switch down to the Off position (1) to disengage the clutch and stop the attachment. NOTE: the PTO will shut off automatically if the operator leaves the seat. To restart the PTO, cycle the PTO switch to the Off position, then back to the On position.

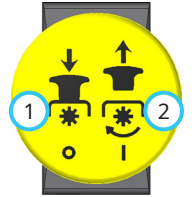

Choke Handle (H)

Pull the choke handle out to aid in starting a cold engine. Push the choke handle in for operation.

Parking Brake (I)

When parking the power unit, always engage the parking brake to prevent accidental movement of the machine.

To engage the parking brake, pull the brake handle back toward the operator.

To disengage the parking brake, pull back slightly on the brake handle to relieve pressure, push down the release button (3) on the top of the handle, and push the handle forward. If the parking brake is engaged, any attempt to move the power unit will shut off the engine. If the operator leaves the seat without engaging the parking brake, the engine will shut off.

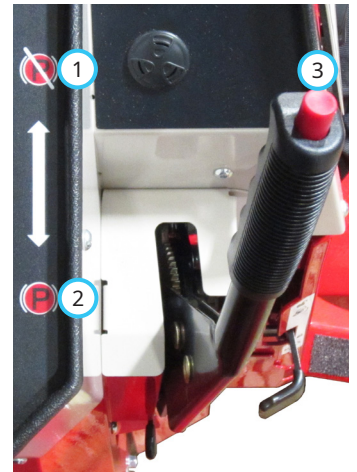

1. Parking Brake Disengaged
2. Parking Brake Engaged
3. Parking Brake Release Button

OPERATIONAL CONTROLS

Neutral Assist Lever (J)

Placing the neutral assist lever in the On position (2) engages the neutral assist spring to help return the SDLA control lever to the neutral position. This makes the neutral position easy to select and maintain. The neutral assist On position is recommended when learning the operation of the power unit, loading or unloading the power unit, attaching and removing attachments, and whenever the operator is unsure of the power unit's response to the task being performed.

Placing the neutral assist lever in the Off position (1) disengages the neutral assist spring. This position is designed for experienced operators when using the power unit in open areas where travel speed and direction are relatively constant and control is easily maintained. The neutral assist Off position reduces operator arm fatigue when using the power unit for prolonged periods of time.

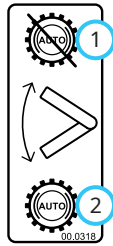

⚠ CAUTION

Stopping the power unit with the neutral assist lever in the Off position requires the operator to manually return the SDLA control lever or foot pedal to the neutral position.

Front Hitch Latch Lever Lock (K)

The front hitch latch lever lock prevents the accidental release of the front hitch latch lever. To release the front hitch latch lever, lift the tab on the front hitch latch lever lock, then move the front hitch latch lever to the unlock position.

Front Hitch Latch Lever (L)

The front hitch latch lever locks and unlocks the hitch latch.

Raise the front hitch latch lever to the unlock position (1) to unlock the hitch latch when attaching or detaching a front mounted attachment.

Lower the front hitch latch lever to the lock position (2) to lock the hitch latch over the hitch arm pins on the attachment. Ensure the lever is secured in the frame notch and the front hitch latch lever lock is in place.

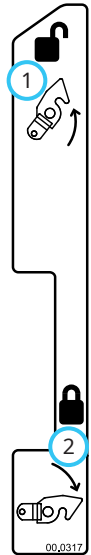

Auxiliary Hydraulic Quick Couplers (M)

The two couplers are a part of the auxiliary hydraulic circuit and are used with an attachment which requires hydraulics (e.g. to angle a dozer blade or rotate the discharge on a snow blower).

PTO Belt Tensioner Rod (N)

The PTO belt tensioner rod applies or releases belt tension to the attachment drive belt.

After placing the attachment drive belt onto the PTO drive pulley, push the PTO belt tensioner rod in (1) until it locks in position with tension applied to the attachment drive belt.

Pulling the PTO belt tensioner rod out (2) releases the belt tension, allowing the operator to remove or install the attachment drive belt.

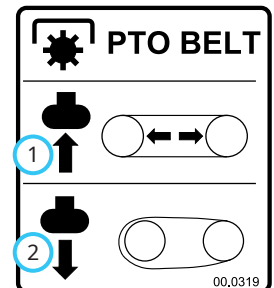

OPERATIONAL CONTROLS

High/Low Shift Lever (O)

ATTENTION

The high/low range shift lever shifts both the front and rear transaxles simultaneously. Occasionally, the engagement of the transaxle gears is prevented by misalignment. Moving the steering wheel slightly to the right or left will move the gears enough to complete the engagement.

CAUTION

Never shift while under load, while moving, or while on a slope. Always ensure the shift lever is secured in the lock position at the end of each shift stroke. Always install the ball pin to prevent the shift lever from accidentally moving to the neutral position.

With the power unit parked on level ground, remove the ball pin (A) and push the shift lever forward to select low range (1).

Move the shift lever to the middle of the shift stroke to place the transaxle gears in neutral (0).

Pull the shift lever back toward the operator to select high range (2).

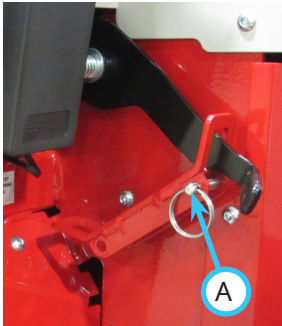

Ensure the shift lever is secured in the lock position at the end of the shift stroke. Reinstall the ball pin (A) into the shift select bracket position at the same end as the shift lever, in order to prevent the shift lever from being accidentally disengaged.

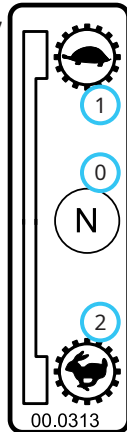

SDLA Control Lever (P & Q)

S.D.L.A. CONTROLS

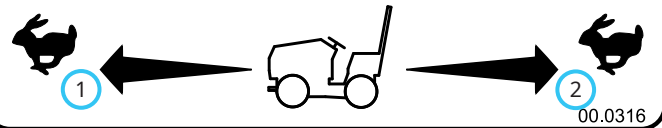
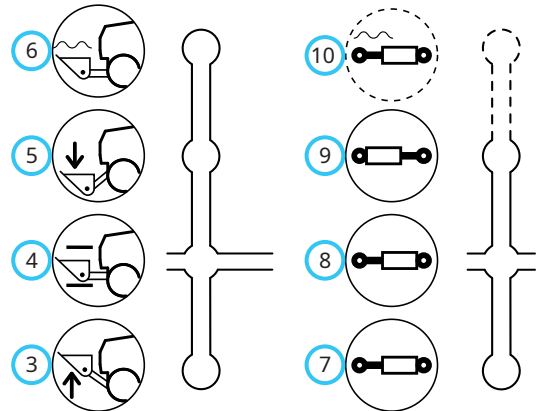

- | | |
|----------------------|-------------------------|
| 1. Forward Direction | 6. Float |
| 2. Reverse Direction | 7. Direction #1 |
| 3. Lift | 8. Hold |
| 4. Hold | 9. Direction #2 |
| 5. Lower | 10. Float (if equipped) |

The SDLA (Speed, Direction, Lift, & Auxiliary) is the primary control for the power unit and consists of two levers. The primary SDLA control lever (P) controls the speed, the direction of travel, and the lift of the hitch arms. The secondary SDLA control lever (Q) controls the auxiliary hydraulic circuit.

- S** - Speed: the amount of forward or backward movement of the primary SDLA lever controls the ground speed of the power unit.
- D** - Direction: the forward or backward movement of the primary SDLA lever controls the direction of the power unit.
- L** - Lift: the lift function of the primary SDLA lever has four positions: Up, Hold, Down, and Float Lock. Hold is the default position and holds the hitch arms from moving up or down. Pulling the lever to the left raises the hitch arms. Pushing the lever to the right lowers the hitch arms. Float position is attained by pushing the lever to the right until the float detent engages and locks the lever in place.
- A** - Auxiliary: the left or right movement of the secondary SDLA lever controls the functions of the attachments that require the auxiliary hydraulic circuit. An optional float kit (part # 23.0111-7) is available for the auxiliary hydraulic circuit.

OPERATIONAL CONTROLS

Steering Wheel (R)

Turn the steering wheel to the left (counterclockwise) to turn the power unit to the left. Turn the steering wheel to the right (clockwise) to turn the power unit to the right.

Hydraulic Cooler Fan Switch (S)

The hydraulic oil cooler fan switch is normally set to the automatic thermostatically controlled position (1). This allows the thermostat to

turn on the cooling fan when the hydraulic fluid reaches the set temperature. The fan pulls air through the right fender next to the operator, through the oil cooler, and discharges the air out the back of the power unit.

The switch can be set to the reverse position (2) to pull air from the rear of the power unit, through the oil cooler, and discharge the warm air next to the operator. This feature can be used to help provide warmth for the operator during cold weather.

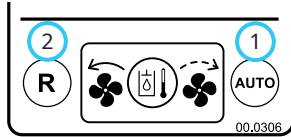

Fuel Shut-off Valve (U)

The fuel shut-off valve controls the flow of fuel to the power unit engine. Turn the valve counterclockwise (1) to the stop to allow fuel to flow to the engine.

Turn the valve clockwise (0) to the stop to shut off fuel flow to prevent fuel leakage when changing the fuel filters or when servicing the fuel system.

Turn off the fuel shut-off valve when transporting the power unit on a truck or trailer and when parking the power unit indoors.

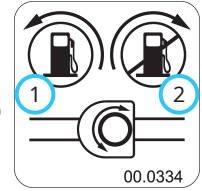

Circuit Breaker & Battery Disconnect (V)

The circuit break/battery disconnect switch controls power to the entire electrical system. Turn the switch to position 1 to allow power to the electrical system. Turn the switch to position (0) to disable the electrical system and allow electrical components to be serviced.

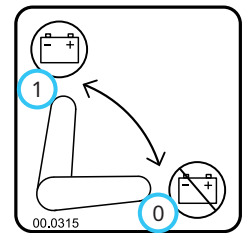

Seat Slide Lever (T)

Move the seat slide lever to the left to release the seat lock. Move the seat forward or backward to the desired position and release the seat slide lever to lock the seat in place.

OPERATIONAL CONTROLS

Seat Prop Plate (W)

The seat prop plate secures the seat in the flipped forward position while service is performed under the seat.

To secure, tilt the seat forward, lift up the seat prop plate, and insert the end into the wide portion of the seat plate slot. Ensure the seat prop plate snaps into the narrow portion of the slot to prevent accidental release.

To release, move the seat prop plate over into the wide portion of the seat slot and tilt the seat forward. Lower the seat prop plate back into the seat box and lower the seat back down to the operating position.

Seat Strap Latch (X)

The seat latch strap secures the seat during transport of the power unit.

To secure the seat, place the tab of the seat latch strap over the seat latch pin. Install the linch pin through the hole in the seat latch pin to secure.

To release the seat so that it can be tilted forward for service, remove the linch pin and lift the tab of the seat latch strap off the seat latch pin.

Work Light Switch (AA)

Press the top (1) of the work light switch to turn on the work lights. Press the bottom (2) of the switch to turn the work lights off.

Strobe Light Switch (BB)

Press the top (1) of the strobe light switch to turn on the strobe light. Press the bottom (2) of the switch to turn the strobe light off.

Slope Indicator Gauge (CC)

(70.4112 & 70.4140)

The 70.4112 digital slope indicator gauge works with a bidirectional slope meter to display the angle of a slope in degrees. NOTE: sudden changes in speed or direction may affect the slope value displayed.

The 70.4140 slope indicator gauge is designed to monitor the total slope angle of the terrain where the power unit is operating. Total slope angle combines side-to-side angle with front-to-back angle to provide a true overall measurement of slope angle, regardless of the power unit orientation. The slope gauge has slope limit set-points that can be changed to match the capability of the power unit configuration along with attachments that might limit the slope rating of the power unit. The slope gauge is equipped with both audible and visual alerts which can be set independently to warn the operator of limiting conditions. The display screen has multiple options to suit the operator preference.

Refer to the Slope Gauge Settings and Operation section for calibration, settings, and operation instructions.

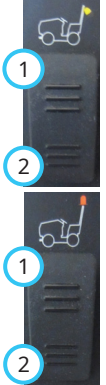

OPERATIONAL CONTROLS

Slope Warning Light (DD) (70.4112 Only)

The slope warning light works with the 70.4112 slope indicator system to provide a visual warning when the slope value exceeds 20 degrees.

Directional Signal Switch (EE)

Press the left side (1) of the directional signal switch to turn on the left turn signal. Press the right side (2) of the directional signal switch to turn on the right turn signal. Return the switch to the middle position to turn off the signals. The left and right turn signals will override the hazard flashers.



Hazard Flasher Switch (FF)

Pressing the right side (1) of the hazard flasher switch flashes both of the directional turn signal lights. Press the left side (2) of the switch to turn the hazard flasher lights off. Use of the directional turn signals will override the hazard flashers until the turn signal is turned off.



Horn Switch (GG)

Press the horn switch to sound the signal horn. The horn will sound until the horn switch is released.

Weight Transfer Traction Control Select Lever (HH)

The weight transfer system transfers weight from the attachment to the front wheels of the power unit. Transferring weight from the attachment to the power unit increases the traction control, improves hillside maneuverability, aids in lifting the attachment, reduces the steering effort, and lessens the attachment resistance when in contact with the ground.

The operator can select different transfer rates by selecting one of the five positions from no weight transfer (0) to maximum weight transfer (4). Set the weight transfer to 0 when attaching or detaching any attachment.

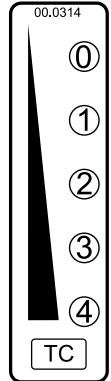

Front Hitch Valve (II)

The front hitch valve is used to control the lowering of the front hitch. Turning the knob on the front hitch valve counterclockwise (1) increases the speed at which the front hitch and attachment can be lowered. Turning the knob clockwise (2) decreases the speed at which the front hitch and attachment can be lowered.

The front hitch and attachment can be locked in any position, so that it will not lower, by turning the front hitch valve knob clockwise until it is completely closed. When operating 3 point hitch implements, it may be helpful to lock the front hitch and attachment in a raised position, to prevent accidental lowering of the front attachment.

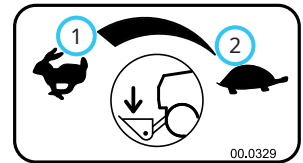

OPERATIONAL CONTROLS

Foot Pedal (JJ)

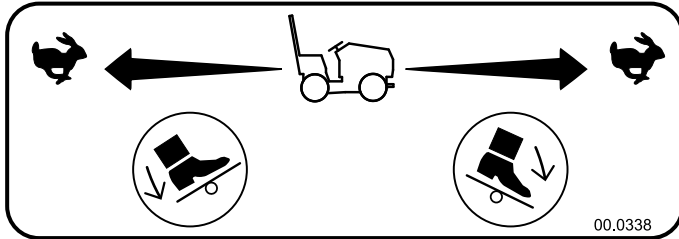

The foot pedal works in conjunction with the SDLA control lever and can be used to control the speed and direction of the power unit when the operator's hand is removed from the SDLA lever.

Press down on the front portion of the foot pedal to move the power unit in the forward direction. Press down on the rear portion of the foot pedal to move in the reverse direction. Changing the amount the foot pedal is depressed will change the ground speed of the power unit.

To slow or stop the power unit, press down on the opposite end of the foot pedal (i.e. if you are travelling forward, press down on the rear of the foot pedal).

3 Point Hitch & Rear Auxiliary Control Handles (KK, LL, and MM)

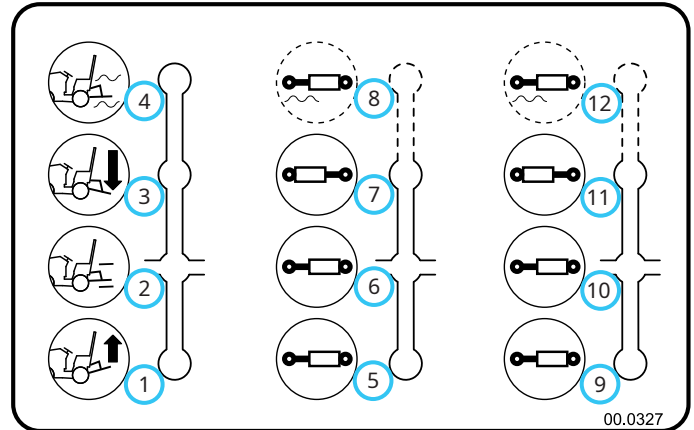

1. 3 Point Hitch Lift
2. 3 Point Hitch Hold
3. 3 Point Hitch Lower
4. 3 Point Hitch Float
5. Left Auxiliary Hyd. Couplers Direction #1
6. Left Auxiliary Hyd. Couplers Hold
7. Left Auxiliary Hyd. Couplers Direction #2
8. Left Auxiliary Hyd. Couplers Float (if equipped)
9. Right Auxiliary Hyd. Couplers Direction #1
10. Right Auxiliary Hyd. Couplers Hold
11. Right Auxiliary Hyd. Couplers Direction #2
12. Right Auxiliary Hyd. Couplers Float (if equipped)

The left control handle (KK) controls the position of the 3 point hitch arms. Pull back on the handle to raise the 3 point hitch arms. Push the handle forward to lower the 3 point hitch arms. Float position is attained by pushing the handle forward until the float detent locks the handle in place.

The middle control handle (LL) controls the left rear set of hydraulic quick couplers. Pull back on the handle to activate the attachment hydraulic cylinder in direction #1. Push the handle forward to activate the attachment hydraulic cylinder in direction #2.

The right control handle (MM) controls the right rear set of hydraulic quick couplers. Pull back on the handle to activate the attachment hydraulic cylinder in direction #1. Push the handle forward to activate the attachment hydraulic cylinder in direction #2.

OPERATIONAL CONTROLS

Rear Auxiliary Quick Couplers (NN)

The rear auxiliary hydraulic quick couplers are used to control auxiliary functions of attachments that are being used with the 3 point hitch. The 3 point hitch includes two sets of hydraulic quick couplers.

12 Volt Rear Switches and 4-Pin Socket (OO, PP, and QQ)

ATTENTION

The 4-pin socket is designed for use with Ventrac original equipment only.

This connector is rated for 20 amp maximum current draw. The engine alternator and/or battery capacity determine allowable continuous draw.

The rear 4-pin socket provides electrical power to rear mounted attachments that are equipped with electrical controls. (e.g. ES220 spreader). The switches turn off and on the electrical power to the rear 4-pin socket.

Press the right side (1) of the upper switch to turn on the electrical power to the 4-pin socket. Press the left side (2) of the switch to turn off the electrical power.

Press and hold either the right (3) or left (4) side of the lower momentary switch to turn on the electrical power to the 4-pin socket. Release the switch to turn off the electrical power.

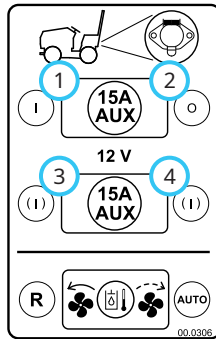

12 Volt Front Switches and 4-Pin Socket (RR, SS, and TT)

ATTENTION

The 4-pin socket is designed for use with Ventrac original equipment only.

This connector is rated for 20 amp maximum current draw. The engine alternator and/or battery capacity determine allowable continuous draw.

The front 4-pin socket provides electrical power to attachments that are equipped with electrical controls (e.g. broom rotation actuator, snow blower discharge chute angle). The switches turn off and on the electrical power to the front 4-pin socket.

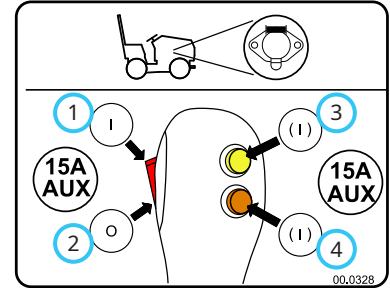

Press the top (1) of the rocker switch to turn on the electrical power to the 4-pin socket. Press the bottom (2) of the rocker switch to turn off the electrical power.

Press and hold either the top (3) or bottom (4) momentary switch to turn on the electrical power to the 4-pin socket. Release the switch to turn off the electrical power.

Electric PTO Remote Socket (UU)

The electric PTO remote socket is used with attachments that are equipped with a remote PTO switch (e.g. HG150 generator), allowing the operator to shut off the power unit PTO from the attachment.

OPERATIONAL CONTROLS

Back Up Alarm (VV)

The back up alarm emits an intermittent signal when the power unit is operated in reverse to alert nearby persons that the power unit is backing up.

Dual Hydraulic Front Coupler Switch (WW)

The optional switch handle is part of the dual front hydraulic auxiliary kit and is used to select which set of quick couplers is controlled by the secondary SDLA lever. The secondary SDLA lever operates the quick couplers with the red and yellow indicators until the button on the handle is pressed. Press and hold the button to switch the secondary SDLA lever to operate the quick couplers with the white and black indicators. Release the button to return to normal operation.

Seat Slide Lever (XX)

Lift up the seat slide lever to release the seat lock. Move the seat forward or backward to the desired position and release the seat slide lever to lock the seat in place.

Lumbar Support Knob (YY)

The lumbar support knob adjusts the curvature of the backrest in either the upper or lower part of the backrest.

Position 0 provides minimal support.

Position 1 provides maximum curvature in the upper part of the backrest.

Position 2 provides maximum curvature in the lower part of the backrest.

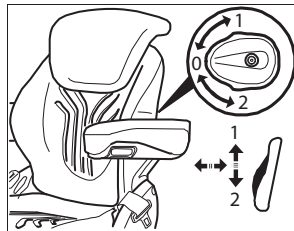

Backrest Angle Lever (ZZ)

Lift up the backrest angle lever to release the backrest catch. Move the backrest to the desired position and release the backrest angle lever to lock the backrest in place.

Weight Adjustment Lever (BA)

The weight setting must be adjusted with the operator sitting on the seat. The weight setting should be checked and adjusted as necessary each time the power unit is operated.

Fold the weight adjustment lever out and move it up or down to adjust the weight setting until the arrow is in the middle of the viewing window.

After adjusting the weight setting, fold the adjustment lever completely into the locking position.

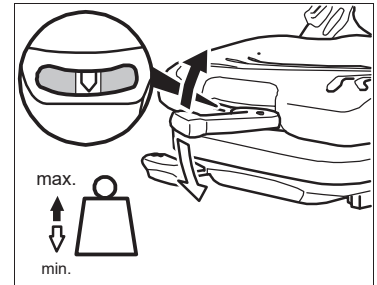

Optional Armrest Angle Knob (BC)

The angle of the optional armrests can be adjusted individually by rotating the knob on the underside of the armrest to raise or lower the front of the armrest.

GENERAL OPERATION

Daily Inspection

WARNING

Always engage the parking brake, shut off the power unit engine, remove the ignition key, and ensure that all moving parts have come to a complete stop before inspecting the components, or attempting any repair or adjustment.

1. Park the machine on a level surface, with the engine shut off and all fluids cold.
2. Perform a visual inspection of the power unit. Look for loose or missing hardware, damaged components, or signs of wear.
3. Inspect the ROPS structure and seat belt for damage or signs of wear.
4. Inspect the battery, the electrical connections, and the lights.
5. Ensure the parking brake is set to the proper tension. Adjust the tension as required.
6. Inspect the hydraulic hoses and the hydraulic fittings to ensure tight, leak free connections.
7. Inspect the fuel lines to ensure tight, leak free connections.
8. Inspect the belts for damage or excessive wear. Refer to the Belt Inspection section of this manual.
9. Check the power unit's engine oil level, the hydraulic oil level, the coolant level (if equipped), and the fuel level. Add fluid or service as required.

ATTENTION

If the power unit is equipped with a cab and heater kit and the outside air temperature is 4° C (40° F) or above, the radiator baffle must be removed and replaced with the radiator screen.

10. Ensure the radiator screen (if equipped), the air cleaner, and the engine compartment are clean.
11. Check the tires for proper inflation.
12. Test the operator safety interlock system.

Starting the Engine

CAUTION

Use of ether or starting fluids may cause engine damage and/or personal injury. Do not use ether or starting fluids to aid in starting the engine.

The 4500 is equipped with an interlock system for operator safety. The safety interlock system requires the parking brake to be engaged and the SDLA lever to be in the neutral position for the power unit to start.

1. Turn the fuel shut-off valve to the On position.
2. Turn the battery disconnect switch to the On position.
3. Pull out the choke handle to the choke or start position. Choke may not be required when the engine is at operating temperature.
4. Move the throttle lever to the fast idle position.

ATTENTION

Do not run the electric starter continuously for more than 5 seconds. If the engine does not start in this time, wait one minute and try again.

5. Turn the ignition key to the start position and hold to engage the starter. Release the key when the engine starts. NOTE: if engine fails to start, refer to the troubleshooting section.

ATTENTION

Allow time for the hydraulic oil to circulate before operating the power unit. Failure to allow adequate warm up time may result in severe damage to the hydraulic system. Warm up time is increased in colder weather.

6. The engine and hydraulic oil must be warmed up before operating. Allow the power unit to run at approximately 1,800 rpm until the hydraulic filter is warm to the touch. The filter is located below the front fuse panel to the left of the dash.

GENERAL OPERATION

Forward and Reverse

Set the neutral assist lever to the desired position. Verify that the intended path is safe and free from obstacles. When safe to move, begin by disengaging the parking brake.

⚠ WARNING

Do not remove your right hand from the SDLA control lever unless you are using an optional foot pedal to control the speed and direction. Forward/reverse direction, speed, and braking are controlled by the SDLA lever or the foot pedal. Your hand or foot must always be ready to brake or stop the power unit.

Power unit movement is controlled by moving the SDLA control lever in the desired direction of travel. Push the SDLA control lever forward to move the power unit in the forward direction. Pull the SDLA control lever backward to move the power unit in the reverse direction. Changing the amount the SDLA control lever is moved changes the ground speed of the power unit. Moving the lever one half of the stroke will result in approximately one half of the maximum ground speed. Moving the lever to the end of the stroke will result in maximum ground speed.

If the power unit is equipped with an optional foot pedal, the foot pedal can be used to control the speed and direction instead of the SDLA control lever.

The SDLA control lever should be used for precision control in tight spaces or when connecting an attachment. The foot pedal is better suited to controlling speed and direction in open areas.

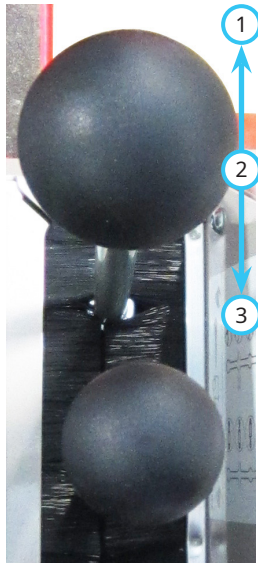

1. Forward
2. Neutral
3. Reverse

Stopping the Power Unit

To slow or stop the power unit, move the SDLA control lever or optional foot pedal toward the neutral position. Return the SDLA control lever or optional foot pedal to the neutral position to make a complete stop.

If in the case of an emergency, the power unit cannot be stopped with the SDLA control lever, pull back on the parking brake lever to engage the parking brake.

⚠ CAUTION

If the parking brake is engaged while the power unit is moving, the engine will shut off and the power unit will come to an abrupt stop.

Shutting Off the Engine

1. Park the power unit on a level surface and engage the parking brake.
2. Move the throttle lever to the slow idle position.
3. Allow the engine to idle for 3 - 5 minutes.
4. Move the throttle lever to the fast idle position.
5. Turn the key to the Off position and remove the key from the ignition switch.
6. When parking the power unit at the end of the day, turn the battery disconnect switch and the fuel shut-off valve to the Off positions.

GENERAL OPERATION

Attaching

1. Drive the power unit slowly forward into the hitch arms of the attachment. Align the lift arms of the power unit with the attachment hitch arms by raising or lowering the front hitch and complete the engagement.
2. Once completely engaged, move the front hitch latch lever to the locked position.
3. Engage the parking brake and shut off the engine.
4. Release the PTO belt tensioner rod*.
5. Place the attachment belt onto the PTO drive pulley on the power unit. Ensure the belt is properly seated in each pulley.
6. Engage the PTO belt tensioner rod.
7. Wipe the attachment hose ends* clean, and connect them to the power unit's hydraulic quick couplers. If equipped, connect the hoses and the quick couplers so the colored indicators are paired together (red to red, etc.).
8. Connect the attachment's electric plug* to the power unit's matching socket.

Detaching

1. Park the power unit on a level surface and engage the parking brake.
2. Fully raise the front hitch and set the weight transfer to 0 (if equipped).
3. Lower the attachment to the ground and place the primary SDLA lever in the float position.
4. Shut off the power unit engine.
5. Release the PTO belt tensioner rod*.
6. Remove the attachment belt from the PTO drive pulley of the power unit.
7. Move the secondary SDLA lever to the left and right to release pressure from the auxiliary hydraulic circuit and disconnect the attachment hoses* from the power unit.
8. Disconnect the attachment's electric plug* from the socket on the power unit.
9. Lift the front hitch lever lock to release the front hitch latch lever and move the front hitch latch lever to the unlocked position.
10. Restart the power unit and slowly back away from the attachment. A side to side movement of the steering wheel may aid in disengagement.

*Applies only if the attachment is equipped.

Refer to the attachment manual for additional details.

Operating Attachments

Read and understand each attachment operator's manual before using the attachment.

Front Hitch

The front hitch is used to secure attachments to the power unit and to raise and lower the attachment. The raise, lower, and float functions of the front hitch are controlled by the primary SDLA control lever.

PTO Drive Belt and Pulley

If the attachment requires a drive belt, release the PTO belt tensioner rod and install the attachment belt around the drive pulley (A)

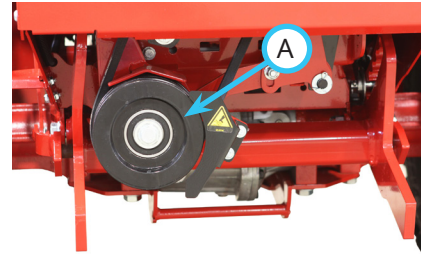

at the location shown above. When

the belt is in place around the drive pulley, push the PTO belt tensioner rod in to engage and tighten the belt.

GENERAL OPERATION

Front Auxiliary Couplers

CAUTION

Dirt and other debris in the hydraulic system can cause damage to the system. Wipe the mating parts of the couplers clean before attaching the hoses to the hydraulic couplers. Install the dust plugs in the hydraulic couplers when not in use.

If the attachment requires auxiliary hydraulics, couple the attachment hoses with the front auxiliary couplers. This is done by sliding the collar on the coupler rearward, inserting the male coupler of the attachment hose into the coupler, and then releasing the collar. If the collar will not snap forward on its own, pull it forward manually.

The couplers that the hoses are attached to will affect the direction the secondary SDLA lever is moved to control the action of the attachment. If the attachment is equipped with colored indicators, connect the hoses to the quick couplers so the colored indicators are paired together.

The auxiliary couplers are controlled by moving the secondary SDLA lever to the left or right.

NOTE: pressure build-up in the attachment hoses and the power unit couplers may occur, causing difficult installation of the hoses. If the hoses do not easily connect, try one or both of the following steps.

1. To release pressure from the power unit couplers, shut off the engine and move the secondary SDLA lever to the left and right to release pressure in the power unit's hydraulic circuit.
2. To release pressure in the attachment hose, loosen the hose end and retighten after the pressure is released.

WARNING

Hydraulic fluid is under high pressure and can penetrate skin causing injury. Keep your hands, face, and body away from pinholes or nozzles that can eject hydraulic fluid under high pressure.

High/Low Range

CAUTION

Never shift range while under load, while moving, or while on a slope. Always ensure the shift lever is secured in the lock position at the end of the shift stroke. Always install the ball pin to prevent the shift lever from accidentally moving to the neutral position.

Always use low range when operating on slopes of greater than 15 degrees.

Low range is recommended for most pulling, pushing, and slow travel. High range is ideal for transport and light duty tasks.

1. Park the power unit on level ground and engage the parking brake.
2. Remove the ball pin and move the shift lever to the desired range position.

ATTENTION

Occasionally the engagement of the transaxle gears is prevented by misalignment. Moving the steering wheel slightly to the right or left will move the gears enough to complete the engagement.

3. Reinstall the ball pin to lock the shift lever in place.

GENERAL OPERATION

Turning Radius

The 4500 power unit has three mounting positions for the steering cylinder that determine the power unit's turning radius.

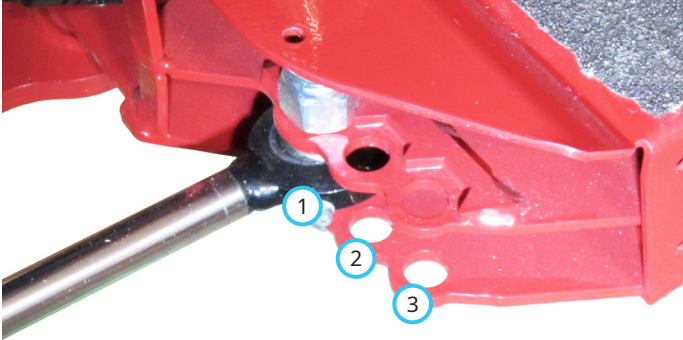

1. **Standard position:** this position is the standard position and enables the tightest turning radius.
2. **Dual wheel position:** the steering cylinder must be installed in this position when operating with dual wheels. The resulting turning radius is larger than position number 1.
3. **Cab and Versa-loader position:** the steering cylinder must be installed in this position when a cab is installed or when operating the Versa-loader. The resulting turning radius is larger than position number 2.

Roll-Over Protection System

WARNING

Keep the ROPS locked in the upright position and the seat belt securely fastened during operation. Failure to do so could result in serious injury or loss of life.

The 4500 power unit is equipped with a fold down ROPS that allows the power unit to access areas of low overhead clearance. Lower the roll bar only when absolutely necessary and raise the roll bar to the upright position as soon as clearance allows.

WARNING

Do not wear a seat belt when the roll bar has been lowered to the down position.

To lower the roll bar:

1. Remove the pins from the right and left hinge plates (1).
2. Fold the roll bar down and install the pins in the hinge plates (2) to lock in place.



To raise the roll bar:

1. Remove the pins from the right and left hinge plates (2).
2. Raise the roll bar to the upright position and install the pins in the hinge plates (1) to lock in place.

GENERAL OPERATION

Weight Transfer

The weight transfer system transfers weight from the attachment to the front wheels of the power unit when the front hitch is in float or assists in lifting the attachment. The operator can select different weight transfer rates using the weight transfer select lever.

To set the weight transfer, raise the front hitch to its maximum height and move the weight transfer select lever to the desired position.

Selecting the proper amount of weight to transfer depends on the attachment, the ground conditions, and operator preference. A lightweight attachment (e.g. KA160 power blower) will not operate in float with full weight transfer on. With full weight transfer on and mowing in the float position, the mower may not lower quickly enough when mowing through uneven terrain. The power unit speed or the weight transfer rate must be reduced.

3 Point Hitch (Optional Accessory)

Some light and medium duty implements (non PTO powered) can be used on the rear of a 3 point hitch equipped power unit.

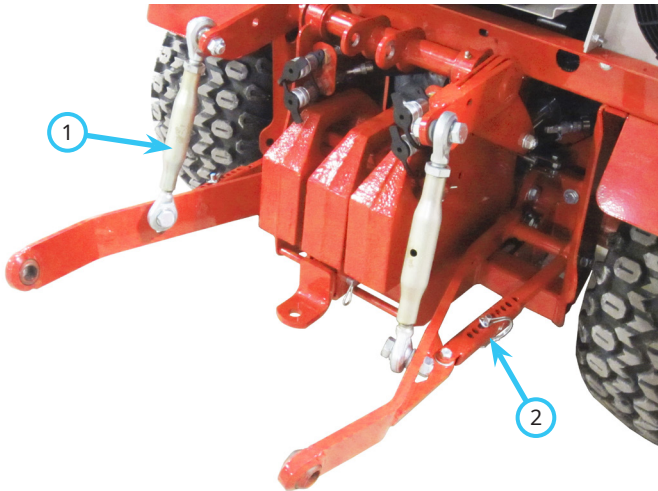

The optional 3 point hitch is equipped with adjustable lift links (1) to control the individual draw bars. The stabilizing links (2) can be allowed to swing freely or can be locked at a desired position.

The 3 point hitch is equipped with three control handles. The inner handle raises and lowers the draw bars. The middle handle controls the left rear set of hydraulic quick couplers. The outer handle controls the right rear set of hydraulic quick couplers.

12 Volt 4-Pin Auxiliary Sockets (Optional Accessory)

Certain attachments require 12 volt auxiliary power. Plug the attachment's 12 volt power cord into the 12 volt 4-pin socket. The actions of the front 12 volt socket are controlled by an on/off switch and two momentary on buttons on the SDLA handle. The actions of the rear 12 volt socket are controlled by an on/off switch and a momentary on/off/on switch on the panel behind the SDLA control levers. The momentary buttons or switch are used for controlling movement that is only used for a brief time. The on/off switches are used to activate equipment or to select different functions.

GENERAL OPERATION

Directional/Hazard Flasher Operation (Optional Accessory)

The directional signal / hazard flasher lights are mounted on adjustable arms. They can be positioned with the arms up (1) for standard use or the arms can be rotated down (2) for use on power units equipped with dual wheels.

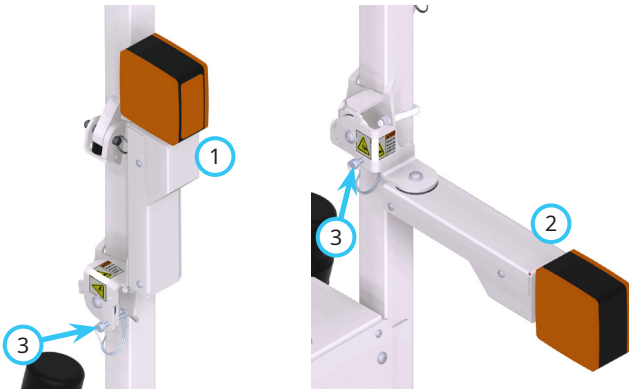

To change the light position, remove the lock pin (3), move the arm to the desired position, and reinstall the lock pin to secure in place.

The light is mounted to the pivot bracket using a friction washer that allows the light to pivot forward or backward when it contacts an object. If the arm gets knocked out of position, manually move the arm back into alignment.

Optional 70.4111 Suspension Seat Kit Weight Adjustment

The suspension seat can be adjusted for the operator's weight.

1. Park the power unit on a level surface and engage the parking brake.
2. With the operator sitting on the seat, turn the knob (A) on the front of the seat clockwise to increase the amount of suspension for a heavier operator. Turn the knob counter-clockwise to reduce the amount of suspension for a lighter operator. Adjust the seat to the comfort of the operator.

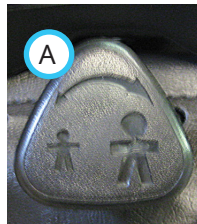

Operating On Slopes

⚠ WARNING

Operation on slopes decreases the power unit stability and increases the potential for unexpected difficulties. Only experienced operators should operate the power unit on slopes and extra caution should be exercised.

Use low range when operating on slopes greater than 15 degrees.

Never shift between high and low range while on a slope. Always move the machine to level ground and engage the parking brake before shifting range.

Avoid uneven, loose, or wet terrain.

Stay clear of drop-offs, holes, ditches, rocks, or objects that could cause a sudden and/or unexpected force on the power unit.

Make slow and cautious starts, stops, and turns.

Do not exceed the maximum degree of operation. Refer to the power unit capability illustrations.

Turn downhill when possible and/or reduce the degree of turns.

Ensure a sufficient supply of fuel for continuous operation. A minimum of one-half tank of fuel is recommended.

To prevent fuel spillage, do not remove the fuel tank cap while the power unit is on a slope.

Failure to follow safety instructions while operating on slopes can result in injury or death. Always use caution when operating on slopes.

ATTENTION

Maximum angle of operation for the engine (Vanguard Model 54) in the 4500K power unit: 20° continuous, 30° intermittent[^].

[^]Intermittent: the engine may operate between 20° and 30° for up to ten minutes. If ten minutes is reached, the engine must be returned to 20° or less to ensure proper oil lubrication. After returning to 20° or less, the intermittent cycle may be repeated.

GENERAL OPERATION

Maintain sufficient fuel in the tank to ensure continuous operation.

Cease operation if the power unit stability is questionable, or if the operator is uncomfortable or unsure of continuing safely.

Attachments can affect the stability of the power unit. Each attachment will affect the power unit differently.

Increase the amount of weight being transferred to the power unit from the attachment while operating on slopes. Refer to the Weight Transfer section.

Always operate carefully and in a manner that does not compromise safety.

Always keep the roll bar in the upright, locked position and fasten yourself securely with the seat belt.

Refer to the following illustrations for power unit capability with different equipment options.

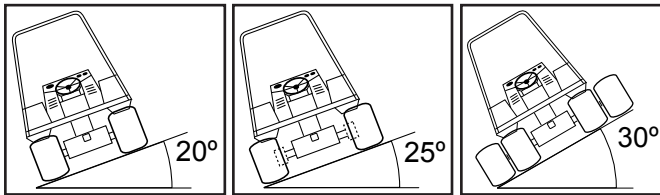

Single Tires

Wheel Extensions

Dual Wheels

Model	Single Tires	Wheel Extensions	Dual Wheels
	Any Direction		
4500	20°	25°	30°

⚠ WARNING

Some attachments or accessories have further limitations on the maximum angle of operation. Refer to the attachment operator's manuals for limitations.

70.4140 Slope Gauge Settings and Operation

⚠ WARNING

Do not attempt to enter or use the options menu while driving the power unit. Park the power unit in a safe location and engage the parking brake before entering the menu to make changes.

Always make sure the slope gauge is calibrated correctly and the slope limit set-points are set to match the power unit configuration prior to operating the power unit.

Never set the slope limit set-points for the audible or visual alerts to a higher value than the power unit configuration can safely handle. Refer to the Operating On Slopes section of this manual and the safety section of the attachment's manual to determine the correct slope limit.

When changing attachments and/or power unit configuration, always update the audible and visual warning set-points to reflect any changes to the maximum slope rating.

Be aware of whether the audible alarm is turned on (enabled) or muted.

Do not depend solely upon the slope gauge alarm to alert you to dangerous situations. Do not operate on slopes that make you feel uncomfortable.

Operation

The slope gauge is equipped with a sensor to the left of the display screen.

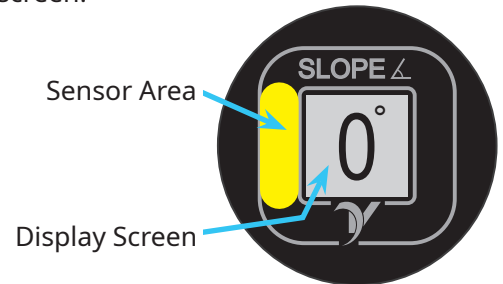

Hold your thumb over the sensor for the required time period to enter the options menu or to make a selection. Follow the instructions on the display screen.



GENERAL OPERATION

Starting below the sensor area, swipe your thumb up across the sensor to scroll through options such as the audible or visual alert set-points or the display screen options.

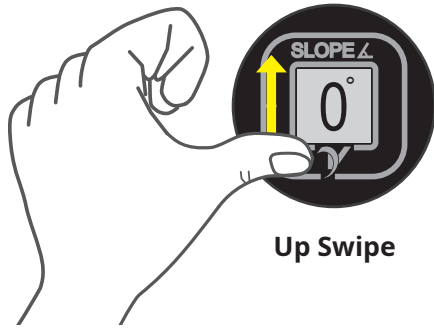

Tips for Selecting and Swiping

- Do not try to hold (select) or swipe while wearing gloves.
- After making a selection or swiping, move your hand away from the gauge before repeating. Swiping too fast or hovering your hand above the sensor area can cause unintentional input.
- If the sensor is not capturing your swipe movements, try increasing or decreasing the distance from the surface of the gauge, slowing down your motion, or using your entire hand instead of just your thumb.

Startup

Every time the power unit is started, the slope gauge will display a Ventrac splash screen, followed by the current set-points for the audible and visual alerts. The startup screen will also show whether the audible alarm is turned on (enabled) or muted.



Alarm Enabled



Alarm Muted

After displaying the startup screen, the slope gauge will return to the last selected display screen and display the current slope.

Menu Options

To calibrate the slope gauge, change audible or visual alert set-points, or to change the display screen, hold your thumb over the slope gauge sensor for eight seconds to enter the options menu. The option screens will display instructions for making changes to the current feature. Swipe up across the sensor to cycle through the menu screens. Each swipe advances one position to the next menu screen. The dots (A) at the top of the screen allow the user to see their screen position (highlighted dot) in the menu.



Menu Screen 1 allows the user to mute or enable the audible alarm. The screen will display the current state of the alarm. Hold over the sensor for three seconds to change the setting.

Menu Screen 2 changes the audible alarm set-point. Hold over the sensor until the set-point angle begins to flash. Swipe up across the sensor to cycle through the set-point options.



Flashing

When the desired set-point is reached, hold over the sensor to save the setting.

Menu Screen 3 changes the visual alarm set-point. Hold over the sensor until the set-point angle begins to flash. Swipe up across the sensor to cycle through the set-point options.



Flashing

When the desired set-point is reached, hold over the sensor to save the setting.

Menu Screen 4 calibrates the slope gauge. This zeros out the gauge at the current position. Refer to the slope gauge calibration section for calibration instructions.

Menu Screen 5 changes the screen display. There are five screen display options from which the operator can choose to display during operation. Hold over the sensor until the factory default screen is displayed. Swipe up to cycle through the display screen options.

GENERAL OPERATION

Display Screen 1 is the factory default screen and it displays the total slope angle in degrees.

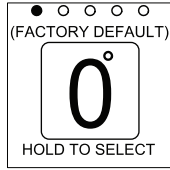

Display Screen 2 displays the total slope angle in degrees, along with the percentage of slope.

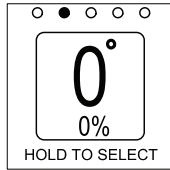

Display Screen 3 displays the total slope angle in degrees, along with a visual horizon and roll indicator.

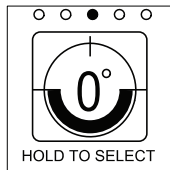

Display Screen 4 displays the total slope angle in degrees, along with independent front-to-back angle and side-to-side angle.

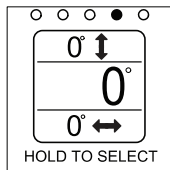

Display Screen 5 displays the total slope angle in degrees, along with independent front-to-back angle and side-to-side angle with position indicators.

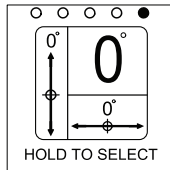

When the desired screen is reached, hold over the sensor to select and save. The slope gauge will remember the selected screen when the power unit is shut off and will display the selected screen when the power unit is restarted.

Menu Screen 6 resets the slope gauge back to the factory default settings. The audible alarm will be turned on, and the audible and visual set-points will be restored to 20 degrees. The slope gauge will need to be recalibrated before operating the power unit. Hold over the sensor until the screen changes to show the default audible and visual alarm settings. Hold over the sensor again until the screen changes to notify you that the reset was successful.

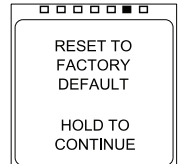

Menu Screen 7 exits the options menu. Hold over the sensor to exit and return to the display screen.

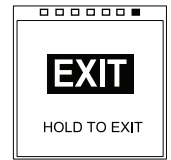

GENERAL OPERATION

Audible and Visual Alerts (70.4140 Gauge)

WARNING

Never set the slope limit set-points for the audible or visual alerts to a higher value than the power unit configuration can safely handle. Refer to the Operating On Slopes section of this manual and the safety section of the attachment's manual to determine the correct slope limit.

Before operation, determine the maximum slope rating for the power unit and attachment configuration. Change the set-points for the audible and visual alerts to match the maximum slope rating. If the power unit is used on a slope angle greater than the set angle, the audible alarm will sound (unless muted) and the display screen will flash a visual warning to alert the operator. If this occurs, slowly and carefully move the power unit off the slope.

70.4140 Slope Gauge Calibration

WARNING

The power unit must be parked on level, horizontal ground in order to be calibrated correctly. Always check to make sure the gauge is calibrated correctly prior to operating the power unit.

1. Park the power unit on a flat, level surface.
2. Shut off the power unit engine and lower any attachments to the ground.
3. Turn the ignition key to the Run position.
4. Enter the options menu and scroll to the calibration screen.
5. Hold your thumb over the sensor until the screen displays a warning message, then remove your thumb. If the requirements in the warning message are met, hold your thumb over the sensor again to perform the calibration.
6. When the screen changes to say calibration successful, remove your thumb from the sensor. The gauge will automatically return to the selected display screen.

Operation in Water, Mud, Snow, or Ice

WARNING

Operation in water, mud, snow, or ice decreases power unit traction and increases the potential for unexpected difficulties or loss of control. Reduce your speed and exercise caution.

WARNING

Operation on frozen bodies of water can be dangerous. The machine could fall through the ice and cause the operator to drown. Never operate on ice unless you have verified the thickness of the ice and that the travel path is safe.

CAUTION

Operation in water may cause damage to the hydraulic system, axles, or other parts. If the water level reaches the tire rim, the water is too deep.

Towing or Pushing the Power Unit

ATTENTION

Avoid damage to your power unit! Before towing, read and understand the following information. Severe damage will occur to the unit if the proper towing procedure is not followed.

CAUTION

Failure to place the transaxles in neutral when towing or pushing the power unit may result in damage to the power unit drivetrain.

If the power unit needs to be moved without the engine running, it is important to remember to place the transaxles in neutral by shifting the high/low range shift handle to the middle of the shift stroke. With the transaxles in neutral and the parking brake disengaged, the power unit can freewheel. Use extreme caution when towing or pushing the power unit as steering may not function. Do not exceed 8 km/h (5 mph). Be prepared to engage the parking brake to stop the power unit.

SERVICE

⚠ WARNING

Always engage the parking brake, shut off the power unit engine, remove the ignition key, and ensure that all moving parts have come to a complete stop before inspecting the components or attempting any repair or adjustment.

ATTENTION

Ventrac recommends that service of the power unit be performed by a qualified technician. If you are unsure how to perform the service procedure(s), contact your Ventrac dealer.

ATTENTION

If any component requires replacement, use only original Ventrac replacement parts.

Service and General Maintenance

Proper and timely service of this power unit is critical to keep the power unit in a safe and reliable operating condition. Follow the maintenance schedule at the end of the service section. For convenience, a frequent service guide decal and a quick reference decal have been placed on the power unit under the hood.

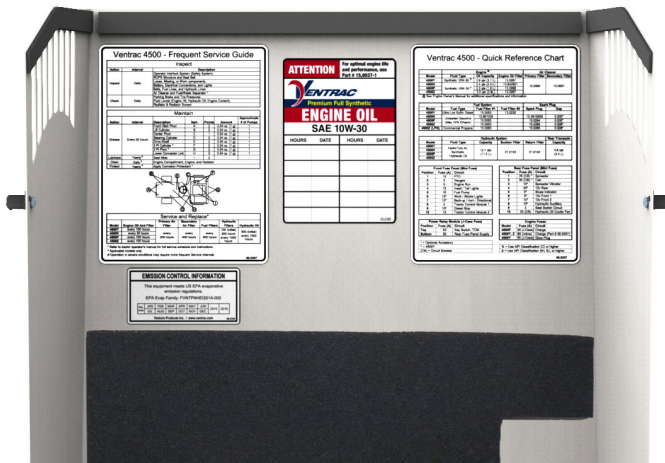

Cleaning and Appearance Care

For best results, and to maintain the finish of the power unit, clean or wash the power unit to remove accumulated clippings, leaves, dirt, gravel, and salt deposits when the job is finished.

ATTENTION

To maintain the finish of the power unit, thoroughly wash the equipment after each use to remove any corrosive agents (e.g. salt). Failure to clean the equipment may result in corrosion of (including but not limited to) steel, aluminum, and electrical components. Equipment that will experience repeated exposure to corrosive agents should be pretreated with a corrosion preventative.

⚠ CAUTION

If the engine has been running, it must be allowed to cool in order to prevent damage to the block and the exhaust manifold.

Do not direct high pressure water at the engine, air cleaner, muffler, radiator, hydraulic oil cooler, or any electrical components.

Allow the power unit and all components to cool before washing. Refer to the specific service sections for proper cleaning techniques for the engine, radiator, and hydraulic oil cooler. Use mild soap and water to clean the power unit. Harsh chemical cleaners could cause damage to the finish or the components.

It is necessary to periodically remove the lower rear frame cover and blow out or wash out any accumulated debris.

After cleaning, use touch up paint to repair any chips or scratches.

SERVICE

Service Access Points

Throughout the service chapter, various access points are referred to. The following list and images identify shields and covers that may need to be removed or opened during service.



- 1. Engine Hood
- 2. Pump Cover
- 3. Right Pump Access Cover
- 4. Right Engine Cover



- 5. Left Engine Cover
- 6. Hydraulic Filter Access Cover
- 7. Seat



- 8. Lower Rear Frame Cover

Lubrication Locations

Lubrication is required at the following locations. Refer to the maintenance schedule for service intervals and the amount of grease. Refer to the fluid capacities and specifications section for the grease type.



Silicone based
Spray Lube

Steering Cylinder and Connector Link

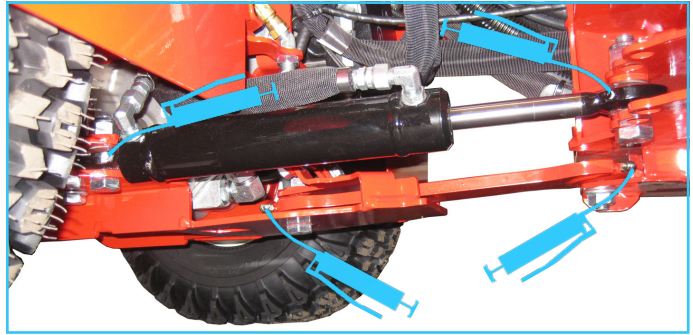

Front Hitch

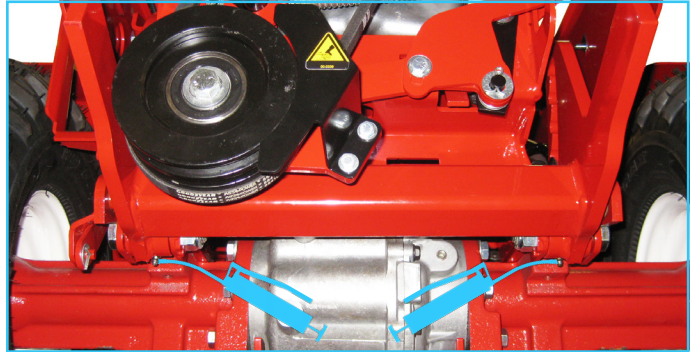

Lift Cylinder



Center Pivot

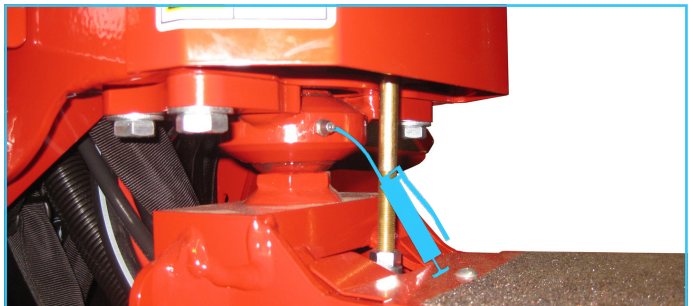

SERVICE

Drive Shaft

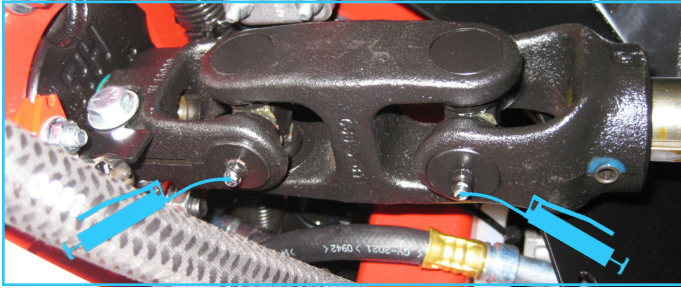

The drive shaft can be greased through access points in the drive shaft cover.

Seat Slide

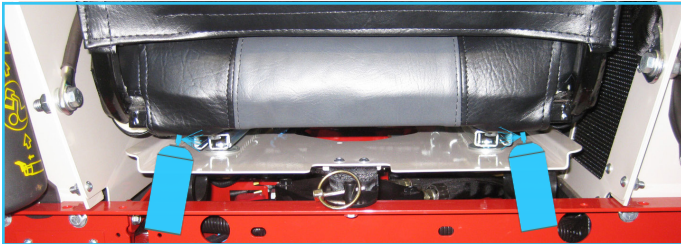

Optional 3 Point Hitch

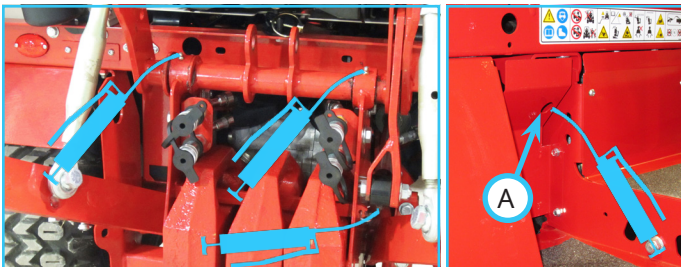

The front grease fitting on the 3 point cylinder can be greased through an access hole (A) in the right foot platform panel.

Checking the Hydraulic Oil Level

Check the hydraulic oil level when the hydraulic system is cold, prior to operating the power unit. If the hydraulic system is warm, allow one hour for the hydraulic system to cool before checking the oil level. Checking the oil level when the hydraulic system is warm will produce an inaccurate oil level reading.

ATTENTION

After connecting a new attachment or kit that runs off the power unit's hydraulic system, run the attachment through a complete cycle, then stop and check the hydraulic oil level.

1. Park the power unit on a level surface and adjust the steering to aim the power unit straight ahead.
2. Fully raise the front hitch and lower the 3 point hitch (if equipped).
3. Shut off the engine and allow time for the hydraulic system to cool.
4. The hydraulic oil tank (A) is located under the hood and dash.
5. Check the oil level in the plastic sight tube (B) next to the hydraulic oil tank. The oil level should be within the proper range indicated by the oil level decal on the hydraulic oil tank.
6. If the hydraulic oil level is below the low mark on the decal, add HydroTorq XL synthetic hydraulic oil until the proper level is reached.

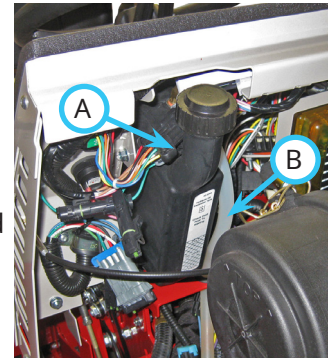

SERVICE

Checking the Rear Transaxle Oil

Check the rear transaxle oil level when the oil is cold, prior to operating the power unit.

1. Remove the rear weights from the hitch bar (if equipped).
2. Remove the oil fill plug (A) from the transaxle and check to see if the oil level is even with the bottom of the oil fill hole.
3. If the oil level is low, add Hydro-Torq XL synthetic hydraulic oil until the oil is level with the bottom of the oil fill hole.
4. If the transaxle is equipped with a pipe plug, clean the oil fill plug and apply pipe sealant to the threads, making sure to leave the last two threads bare to prevent the thread sealant from contaminating the hydraulic oil. Reinstall the plug into the rear transaxle and tighten 1 to 1-1/2 turns past finger tight (approximately 48-54 Nm / 35-40 ft-lbs of torque).
If the transaxle is equipped with an o-ring plug, reinstall the plug into the rear transaxle and torque to 34-39 Nm (25-29 ft-lbs).

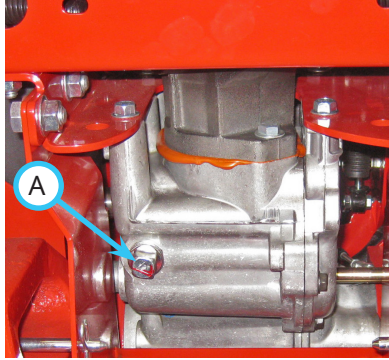

ATTENTION

Do not overtighten the transaxle plug. Overtightening can cause the transaxle case to crack.

5. Clean up any spilled oil.
6. Reinstall the rear weights (if equipped).

Changing the Hydraulic Oil Filters

1. If the power unit has been running, allow time for the hydraulic system to cool.

⚠ WARNING

Hot oil can cause severe burns. Allow the oil temperature to drop from hot to warm before changing the oil filters.

2. Remove the hydraulic filter access cover.
3. Clean the hydraulic filters, the filter heads, and the area around the filters.
4. Place a drain pan (minimum 3.8 liter / 4 quart) under the hydraulic filters.
5. Use a strap type filter wrench to unscrew both the large (A) and small (B) hydraulic filters from the filter heads and allow the oil to drain into the pan.
6. Wipe the filter mounting surfaces with a clean cloth.
7. Apply a thin film of clean oil to the gasket of the new large filter and screw onto the filter head until the gasket makes contact with the mounting surface. Tighten the filter an additional 3/4 of a turn (may require using a strap type filter wrench).
8. Apply a thin film of clean oil to the gasket of the new small filter and screw onto the filter head until the gasket makes contact with the mounting surface. Tighten the filter an additional 1 turn (may require using a strap type filter wrench).
9. Clean up any spilled oil and dispose of oil and filters in accordance with local laws.

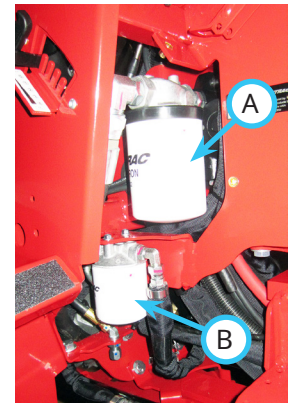

ATTENTION

Oil is hazardous to the environment. Drain oil into an approved container and dispose of used oil in accordance with local laws.

10. If the hydraulic oil is being changed at the same time as the filters, skip the remaining steps and proceed to the Changing the Hydraulic Oil section.
11. Add HydroTorq XL synthetic hydraulic oil to the hydraulic oil tank until the oil level in the plastic sight tube is within the proper range indicated by the oil level decal.
12. Start the power unit and let it run at low idle

SERVICE

engine speed for a few minutes. Turn the steering wheel to the left and right a couple of times to purge any trapped air out of the hydraulic system.

13. Shut off the power unit engine and allow the power unit to sit for a minimum of five minutes.
14. Check the hydraulic oil level. Refer to the Checking the Hydraulic Oil Level section.
15. Inspect both of the hydraulic filters for signs of leakage. If any leaks are evident, the filter may need tightened further, or the filter may need to be removed, the gasket and filter mount cleaned, and the filter reinstalled following the procedures for changing the filter.
16. Reinstall the hydraulic filter access cover.

Changing the Hydraulic Oil

1. Wash the underside of both the front and rear transaxles thoroughly.
2. Park the power unit on a level surface and adjust the steering to aim the power unit straight ahead.
3. Fully raise the front hitch and lower the 3 point hitch (if equipped).
4. Shut off the engine and allow time for the hydraulic system to cool.

⚠ WARNING

Hot oil can cause severe burns. Allow the oil temperature to drop from hot to warm before draining the hydraulic oil.

5. Place a drain pan (minimum 13.5 liter / 14 quart) under the front transaxle.
6. Remove the drain plug (A) from the front transaxle and allow the hydraulic oil to drain from the system. Loosen the cap on the hydraulic oil tank to allow venting.

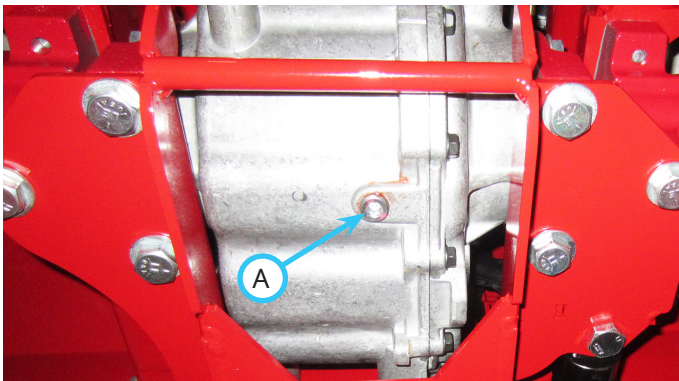

7. If the transaxle is equipped with a pipe plug, clean the drain plug and apply pipe sealant to the threads, making sure to leave the last two threads bare to prevent the thread sealant from contami-

nating the hydraulic oil. Reinstall the plug into the front transaxle and tighten 1 to 1-1/2 turns past finger tight (approximately 48-54 Nm / 35-40 ft-lbs of torque).

If the transaxle is equipped with an o-ring plug, reinstall the plug into the rear transaxle and torque to 34-39 Nm (25-29 ft-lbs).

ATTENTION

Do not overtighten the transaxle plug. Overtightening can cause the transaxle case to crack.

8. Clean up any spilled oil and dispose of oil in accordance with local laws.

ATTENTION

Oil is hazardous to the environment. Drain oil into an approved container and dispose of used oil in accordance with local laws.

9. If the hydraulic filters are being changed with the oil, proceed to the Changing the Hydraulic Oil Filters section before completing the remaining steps in this section.
10. Add HydroTorq XL synthetic hydraulic oil to the hydraulic oil tank until the oil level in the plastic sight tube is within the proper range indicated by the oil level decal.
11. Start the power unit and let it run at low idle engine speed for a few minutes. Turn the steering wheel to the left and right a couple of times to purge any trapped air out of the hydraulic system.
12. Shut off the power unit engine and allow the power unit to sit for a minimum of five minutes.
13. Check the hydraulic oil level. Refer to the Checking the Hydraulic Oil Level section.

SERVICE

Changing the Rear Transaxle Differential Oil

1. Remove the rear weights from the hitch bar (if equipped).
2. Place a drain pan (minimum 5.5 liter / 6 quart) under the rear transaxle.

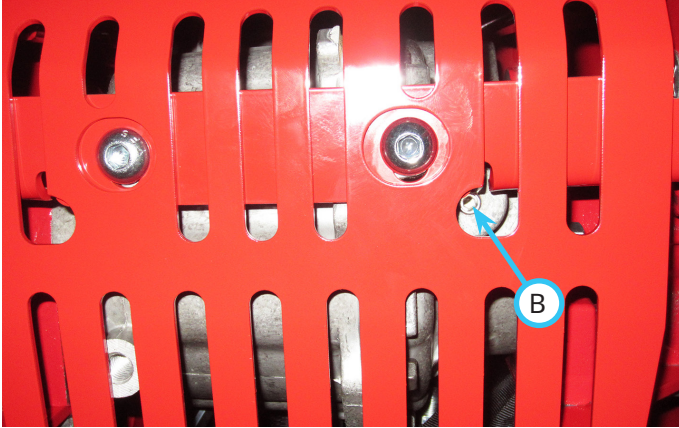

3. Remove the drain plug (B) from the rear transaxle and allow the hydraulic oil to drain. Remove the oil fill plug (C) from the rear transaxle to allow venting. NOTE: on some power units, it

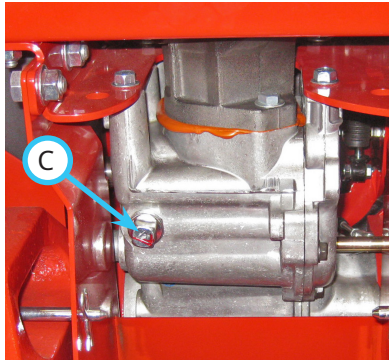

- may be necessary to remove the rear transaxle skid plate to access the drain plug.
4. If the transaxle is equipped with a pipe plug, clean the drain plug and apply pipe sealant to the threads, making sure to leave the last two threads bare to prevent the thread sealant from contaminating the hydraulic oil. Reinstall the plug into the rear transaxle and tighten 1 to 1-1/2 turns past finger tight (approximately 48-54 Nm / 35-40 ft-lbs of torque).
If the transaxle is equipped with an o-ring plug, reinstall the plug into the rear transaxle and torque to 34-39 Nm (25-29 ft-lbs).

ATTENTION

Do not overtighten the transaxle plug. Overtightening can cause the transaxle case to crack.

5. Add HydroTorq XL synthetic hydraulic oil (approximately 3.8 liters / 4 quarts) to the fill port in the rear transaxle until the oil is level with the bottom

of the oil fill hole.

6. If the transaxle is equipped with a pipe plug, clean the drain plug and apply pipe sealant to the threads, making sure to leave the last two threads bare to prevent the thread sealant from contaminating the hydraulic oil. Reinstall the plug into the rear transaxle and tighten 1 to 1-1/2 turns past finger tight (approximately 48-54 Nm / 35-40 ft-lbs of torque).
If the transaxle is equipped with an o-ring plug, reinstall the plug into the rear transaxle and torque to 34-39 Nm (25-29 ft-lbs).
7. Clean up any spilled oil and dispose of oil in accordance with local laws.

ATTENTION

Oil is hazardous to the environment. Drain oil into an approved container and dispose of used oil in accordance with local laws.

8. If the rear transaxle skid plate was removed to access the drain plug, reinstall the skid plate.
9. Reinstall the rear weights (if equipped).

SERVICE

Servicing the Closed Loop Hydrostatic Drive Circuit

ATTENTION

Service or repair of the closed loop drive circuit must be performed by an authorized Ventrac dealer. If any part of the closed loop hydrostatic drive circuit (the pump, the front drive motor, the rear drive motor, or any of the three 1/2" hydraulic lines connecting them together) is serviced or replaced, the Ventrac closed loop drive circuit filtration procedure must be performed. The procedure requires a special Ventrac remote filtering tool and must be performed by a Ventrac authorized technician.

Servicing the Hydraulic Cooler

1. Brush dirt and debris from the oil cooler screen in the right fender.
2. With the ignition key turned to the run position, flip the oil cooler fan switch from Auto to Reverse operation to blow dust off the oil cooler fins.
3. Place the fan switch back into the Auto position.

Checking the Engine RPM

Check the engine RPM when the engine is warm and not under load. Observe the tachometer:

- Low idle speed = 1,550 ±50 RPM
- High idle speed = 3,600 ±50 RPM

If engine RPM is incorrect, contact your Ventrac dealer.

Checking the Engine Oil Level

ATTENTION

Failure to check the engine oil regularly could lead to serious damage to your engine, if the engine is run with an incorrect oil level.

- Check the engine oil level with the power unit sitting on a level surface and with the engine shut off and the oil cold.
- Keep the oil level between the **Full** and **Add** marks.
- Do not add oil with the engine running.

1. If the power unit has been running, allow the engine and oil to cool.
2. Remove the oil dipstick (A) from the engine and wipe with a clean cloth.

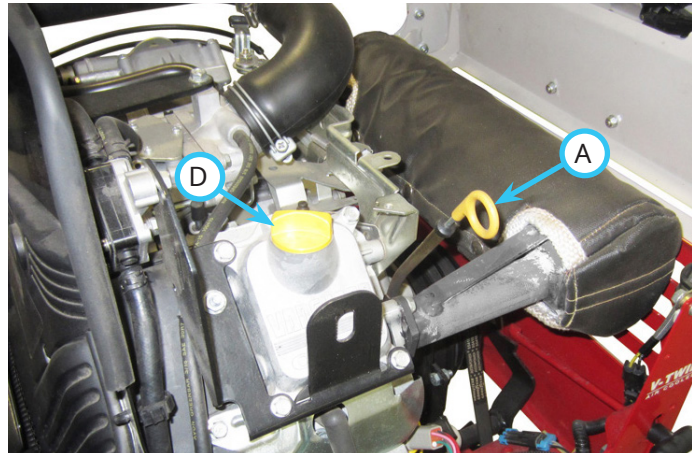

3. Insert the dipstick back into the engine and remove again.
4. Check the oil level. The level should be between the Full (B) and Add (C) marks on the dipstick.
5. If the oil level is low, remove the oil fill cap (D) and add small amounts of engine oil to bring the oil level no higher than the Full (B) level on the dipstick.
6. If the oil level is above the Full (B) mark, drain some engine oil to achieve the proper level.
7. Reinstall the dipstick and the oil fill cap.

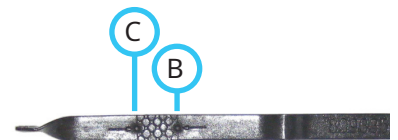

SERVICE

Changing the Engine Oil and Filter

⚠ CAUTION

Contact with engine oil can irritate your skin. Wear protective gloves when working with engine oil. If you come in contact with engine oil, wash it off your skin immediately.

ATTENTION

Oil is hazardous to the environment. Drain engine oil into an approved container. Dispose of used engine oil in accordance with local laws.

1. Start the power unit engine and allow it to run until the engine reaches operating temperature.
2. Park the power unit on a level surface.
3. Shut off the engine and allow the engine to cool from hot to warm.

⚠ WARNING

Hot engine oil can cause severe burns. Allow the engine temperature to drop from hot to warm before draining the engine oil.

4. Remove the right engine cover to access the oil filter.
5. Place a drain pan underneath the oil drain (A) located in front of the hydraulic oil filters on the left side of the power unit.
6. Remove the drain cap from the oil drain and drain into the pan while the oil is warm.
7. Remove the oil filter (B) located on the side of the engine.
8. Wipe the filter mounting surface with a clean cloth.
9. Apply a thin film of clean oil to the gasket of the new oil filter.
10. Screw the new filter onto the engine until the gasket makes contact with the mounting surface. Tighten the filter 1/2 to 3/4 turn more by hand.
11. Install the drain cap onto the oil drain. Do not overtighten.

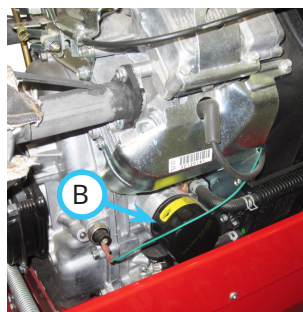
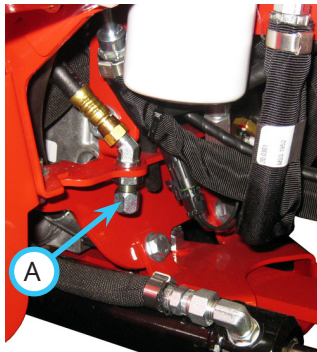

12. Remove the oil fill cap.
13. Add oil to the engine. Refer to the Engine Owner's Manual for proper oil specifications and capacity.

ATTENTION

For optimal engine life and performance, use Ventrac full synthetic engine oil (Part Number 15.0037-1).

14. Install the oil fill cap and wipe up any oil spills.
15. Start the power unit and let it run at low idle engine speed for approximately two to three minutes.
16. Shut off the engine and remove the ignition key.
17. Check for leaks around the oil filter. If any leaks are evident, the filter may need tightened further, or the filter may need to be removed, the gasket and filter mount cleaned, and the filter reinstalled.
18. Check the engine oil level after allowing the engine to cool for approximately two minutes and add oil if necessary.
19. Reinstall the right engine cover.

SERVICE

Changing the Air Filter Elements

ATTENTION

When both air filter elements are removed, an opening is created to the internal parts of the engine. Be sure nothing falls into the canister that could make its way into the engine. Have the new filter elements ready to install immediately after removing the old filter elements.

Improper service to the engine air filter can result in severe engine damage.

- Inspect the filter daily in extreme heat, dust, or other severe conditions.
- Never run the engine without a proper air filter installed.
- Never wash or clean the paper filter element.

1. If the power unit has been running, allow the engine to cool.
2. Release both latches (B) on the engine air filter assembly (A) and unhook the latches from the main filter housing.

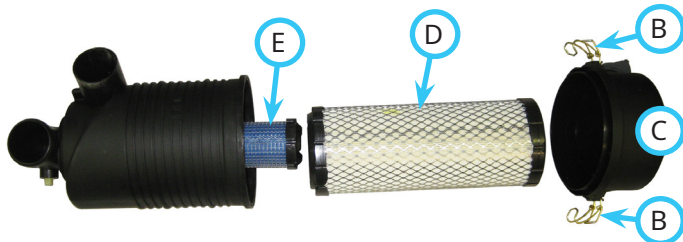
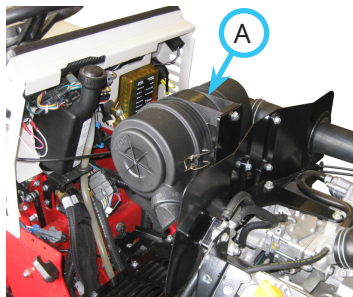

3. Remove the filter cap (C).
4. Remove and discard the primary (outer) air filter element (D).
5. If the safety (inner) air filter element (E) is scheduled for replacement, remove and discard the safety air filter element.
6. Install the new air filter element(s).
7. Reinstall the filter cap and fasten both latches.

Filling the Fuel Tank

⚠ DANGER

Fuel is flammable and explosive. Follow all safety instructions in the Fuel Safety section and in the Engine Owner's Manual.

⚠ WARNING

Long term exposure to fuel vapors can cause serious injury or illness. Avoid prolonged breathing of fuel vapors.

If fuel is spilled on your skin or clothing, change your clothing and wash the affected area immediately.

ATTENTION

Improper fuel can damage your engine. Only use fuel that meets the fuel grade and specifications listed in the Engine Owner's Manual.

1. Park the power unit on a level surface.
2. If the power unit has been running, allow the engine to cool.
3. The fuel tank cap is located on top of the left rear fender. Wipe any dust and dirt off the fuel cap to prevent dirt from falling into the fuel tank and remove the fuel cap.
4. Add fuel to the tank until the fuel level reaches the bottom of the fuel neck*. Do not overfill the tank by filling the fuel neck, as this may cause engine flooding, fuel leakage from the tank, and/or damage to the emissions control system. Keep the fuel nozzle in contact with the rim of the fuel neck until fueling is completed.
5. Replace the fuel cap and tighten.
6. Wipe up any fuel spills and allow fuel vapors to dissipate before starting the engine.

*If the power unit will not be used after filling the fuel tank, only fill the tank to within 25 mm (1 inch) of the bottom of the fuel neck to allow room for fuel expansion from temperature changes. Failure to do so may cause engine flooding, leakage from the tank, and/or damage to the emissions control system.

SERVICE

Changing the In-line Fuel Filter

1. Turn the fuel shut-off valve to the Off position.
2. Remove the lower rear frame cover.
3. Loosen the hose clamps and remove the fuel filter (A).
4. Install the new fuel filter with the arrow pointing toward the engine and fasten securely with the hose clamps.
5. Turn the fuel shut-off valve to the On position.
6. Inspect the fuel filter hose connections for leaks.
7. Reinstall the lower rear frame cover.

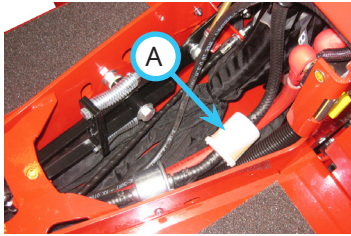

Priming the Fuel System

1. Turn the ignition key to the run position for approximately 30 seconds. The operator should hear the fuel pump operating.
2. Start the power unit. Repeat step 1 if necessary.

Cleaning the Engine Compartment and Engine

Clean the engine compartment and the engine daily or prior to each use, to reduce the risk of the engine overheating or the ignition of accumulated debris.

1. If the power unit has been running, allow the engine to cool.
2. Remove the left and right engine covers.
3. Remove accumulated debris and dust from the engine compartment and the engine.
4. Remove the carburetor access panel (A) from the engine to clean around the carburetor and linkage.

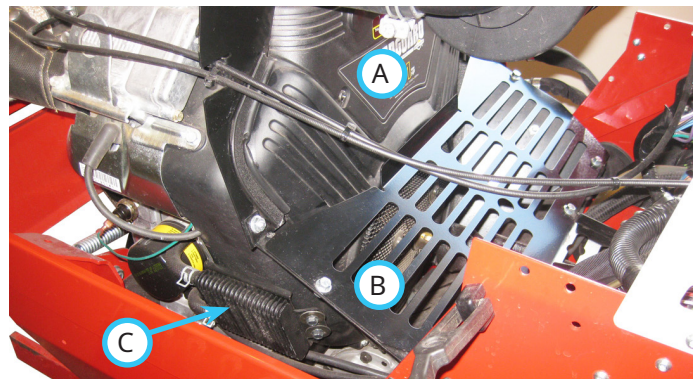

5. Remove the drive shaft cover (B) and clean debris from the rotating screen.
6. Clean the oil cooler (C) using a brush or compressed air to remove dust and debris.
7. Reinstall the carburetor access panel.
8. Reinstall the drive shaft cover.
9. Reinstall the left and right engine covers.

SERVICE

Servicing the Battery

⚠ DANGER

The battery produces a flammable and explosive gas. The battery may explode.

- Wear eye protection and gloves.
- Do not smoke near the battery.
- Keep arcs, sparks, and open flames away from the battery.
- Do not allow direct metal contact across the battery posts.
- Remove the negative battery cable first when disconnecting the battery.
- Install the negative battery cable last when connecting the battery.

⚠ WARNING

Battery electrolyte contains sulfuric acid. It is poisonous and can cause severe chemical burns.

1. Wear eye and skin protection.
2. If battery electrolyte is spilled on your skin or clothing, change your clothing and wash the affected skin immediately. Seek medical attention, if necessary.
3. If battery electrolyte is splashed into your eyes, flush immediately with water for 15-30 minutes and seek immediate medical attention.
4. If battery electrolyte is swallowed, get medical attention immediately. Drink large quantities of water, followed by Milk of Magnesia, beaten egg, or vegetable oil. DO NOT induce vomiting.

ATTENTION

Batteries contain poisonous and hazardous substances. Dispose of used batteries in accordance with local laws.

Removing the Battery

1. Tilt the seat forward and fasten in place with the seat prop.
2. Remove the left foot platform panel (A).
3. Disconnect the negative (-) battery cable (B).
4. Disconnect the positive (+) battery cable (C).

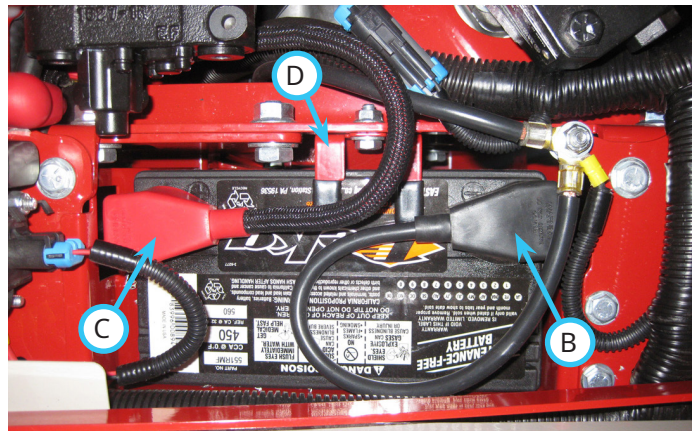
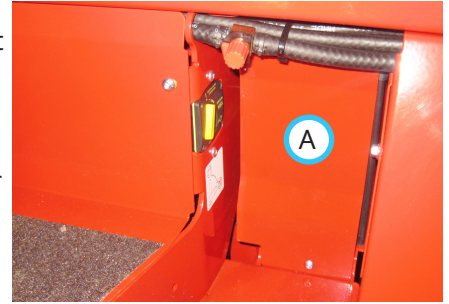

5. Remove the battery retainer (D).
6. Slide the battery forward out of the battery compartment.

Installing the Battery

1. Slide the battery into the battery compartment with the negative (-) post to the rear.
2. Install the battery retainer and torque the bolt to 24 Nm (210 in-lbs).
3. Install the left foot platform panel and torque the bolt to 11 Nm (100 in-lbs).
4. Connect the positive (+) battery cable to the positive battery post first.
5. Connect the negative (-) battery cable to the negative battery post last.
6. Apply dielectric grease to the battery terminals to prevent corrosion.
7. Place the covers back over the battery terminals.

SERVICE

Cleaning the Battery and Terminals

1. Remove the battery from the power unit.
2. Wash the battery with a solution of 60 mL (4 table-spoons) of baking soda to 3.8 liters (1 gallon) of water. Do not allow the soda solution to get into the battery cells.
3. Rinse the battery with clean water.
4. Clean the battery posts and battery cable terminals with a wire brush.
5. Reinstall the battery.

Charging the Battery

! DANGER

Batteries produce explosive gases. Charge the battery in a well ventilated area where the gases produced by charging can dissipate. Do not charge where the battery could be exposed to sparks, open flames, or other sources of ignition.

Never charge a frozen battery, as it may explode. Allow the battery to warm up and inspect for cracks or damage before charging.

To preserve optimum battery performance and life, do not allow the battery to stand in a discharged state for long periods of time. If the battery is not being used, check the battery voltage every 30 days and recharge the battery if the voltage drops to 12.4 volts or lower.

Keep the battery fully charged in cold weather to prevent damage due to freezing.

1. If possible, remove the battery from the power unit before charging.
2. Refer to the battery charger's manual for specific charging instructions.
3. If electrolyte is expelled or excessive gassing occurs, or if the temperature of the battery exceeds 52° C (125° F), charging must be temporarily stopped to permit cooling. After cooling, reduce the charging rate before starting the charger again.

Jump Starting Procedure

! DANGER

The battery produces a flammable and explosive gas. The battery may explode.

- Wear eye protection and gloves.
- Do not jump start a cold or frozen battery. Allow the battery to warm up and inspect for cracks or damage.
- Do not jump start a cracked or damaged battery.
- Do not attempt to jump start the power unit using a battery of a different voltage.

1. Inspect the discharged battery for terminal corrosion and loose connections. Clean the terminals and tighten the connections prior to jump starting.
2. Make sure the vehicle used to jump start the power unit has a 12 volt, negative ground, electrical system.
3. Pull the boosting vehicle up close to the disabled power unit. Be sure the vehicles do not touch.
4. Shut off the boosting vehicle's engine and engage the parking brake.

ATTENTION

Attempting to start the disabled unit with the boosting vehicle's engine running could cause damage to the regulator.

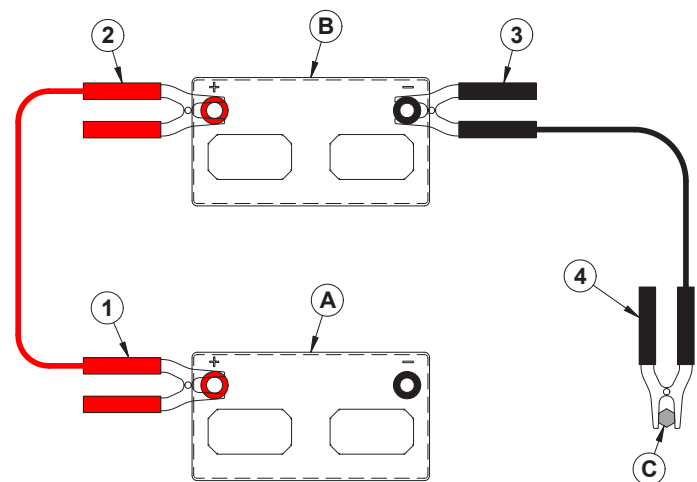

A. Discharged Battery C. Ground Stud
B. Booster Battery

5. Connect one end of the positive (+) booster cable to the positive (+) terminal (1) of the discharged battery.

SERVICE

6. Connect the other end of the positive (+) booster cable to the positive (+) terminal (2) of the booster battery.
7. Connect the negative (-) booster cable to the negative (-) terminal (3) of the booster battery.
8. Connect the other end of the negative (-) booster cable to the disabled power unit's ground stud (4).
9. Start the disabled power unit and remove the booster cables in reverse order of installation (negative booster cable first).

TCM (Tractor Control Module) Explanation

The tractor control module (A) is a sealed computerized device designed to control the electronic safety related functions of this power unit. Both solid state and mechanical components are used to ensure the safe, reliable operation of this machine.

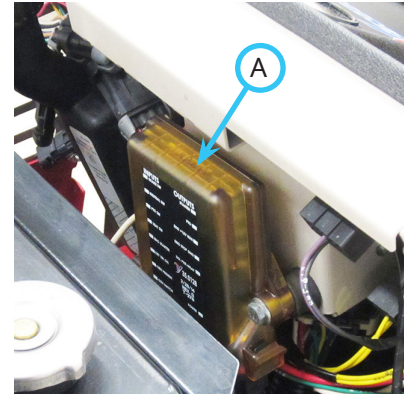

This TCM monitors the electronic circuits necessary for the engine, the starter, and the PTO to function. These input circuits include the PTO switch, the neutral switch, the parking brake switch, the ignition switch, the seat switch, and the generator presence. The TCM is programmed to allow the engine, the starter, or the PTO to operate only when specific input criteria are satisfied. The engine, the starter, and the PTO are controlled by outputs from the TCM.

For additional information, refer to the TCM section of the troubleshooting guide.

Replacing Fuses (Power Relay Module)

1. Turn the battery disconnect switch to the Off position.
2. Tilt the seat forward and fasten in place with the seat prop.
3. Remove the sealed fuse cap from the power relay module.
4. Identify and remove the defective fuse from the socket.

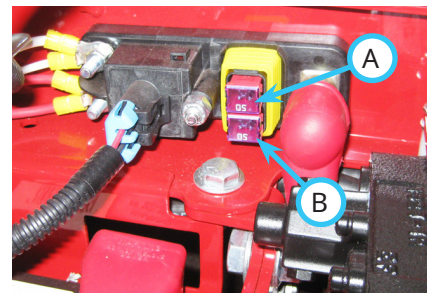

Power Relay Module (J-Case Fuse)		
Position	Fuse	Circuit
Top (A)	50 amp	Key Switch, TCM
Bottom (B)	50 amp	Rear Fuse Panel Supply

5. Insert a new fuse into the socket. Be sure the fuse is the correct amperage or damage may occur to the power unit.
6. Reinstall the sealed fuse cap and lower the seat back down to the operating position.
7. Turn the battery disconnect switch to the On position.

SERVICE

Replacing Fuses (Front Fuse Panel)

1. Turn the battery disconnect switch to the Off position.
2. Remove the sealed cover (A) from the fuse panel.
3. Identify and remove the defective fuse from the socket.

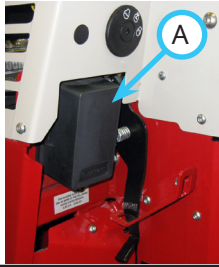

Front Fuse Panel (Mini Fuse)		
Position	Fuse	Circuit
1	15 amp	PTO
2	5 amp	Gauges
3	5 amp	Engine
4	15 amp	Lights
5	10 amp	Fuel Pump
6*	15 amp	Work/Strobe Light
7*	10 amp	Back-up / Horn / Directional
8	5 amp	Tractor Control Module 1
9^	10 amp	Diesel Stop
10	15 amp	Tractor Control Module 2

*Optional accessory

^Diesel only

4. Insert a new fuse into the socket. Be sure the fuse is the correct amperage or damage may occur to the power unit.
5. Reinstall the sealed cover onto the fuse panel.
6. Turn the battery disconnect switch to the On position.

Replacing Fuses (Rear Fuse Panel)

1. Turn the battery disconnect switch to the Off position.
2. Tilt the seat forward and fasten in place with the seat prop.
3. Remove the sealed cover (A) from the fuse panel.
4. Identify and remove the defective fuse from the socket.

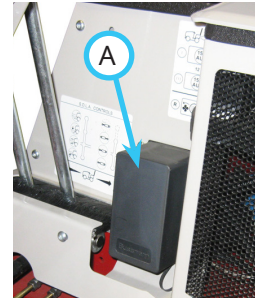

Rear Fuse Panel (Mini Fuse)		
Position	Fuse	Circuit
1*	25 amp (CB)	Spreader
2*	30 amp (CB)	Cab
3*	10 amp	Vibrator for Spreader
4*	20 amp	12V Rear
5*	5 amp	Slope Indicator
6*	5 amp	12V Front 1
7*	15 amp	12V Front 2
8*	10 amp	Hydraulic Aux
9	5 amp	Seat Switch Circuit
10	25 amp (CB)	Hydraulic Oil Cooler Fan

*Optional accessory

5. Insert a new fuse into the socket. Be sure the fuse is the correct amperage or damage may occur to the power unit.
6. Reinstall the sealed cover onto the fuse panel and lower the seat back down to the operating position.
7. Turn the battery disconnect switch to the On position.

Switching the Speedometer (mph or km/h)

The wire harness connection for the speedometer is under the right side of the dash above the hydraulic oil tank. Locate the green wire (labeled B-144) with an individual plug.

1. For a speedometer readout in miles per hour, the green wire (B-144) should be connected to the wire from the information gauge that is labeled B-142.
2. For a speedometer readout in kilometers per hour, the green wire (B-144) should be connected to the wire from the information gauge that is labeled B-143.

SERVICE

Replacing Light Bulbs (Headlights and Halogen Work Lights)

⚠ CAUTION

The light bulb contains gases under pressure. The bulb may shatter if the glass is scratched or dropped. Wear eye protection and handle bulb with care.

1. Remove the two screws (A) from the light cover and remove the cover.

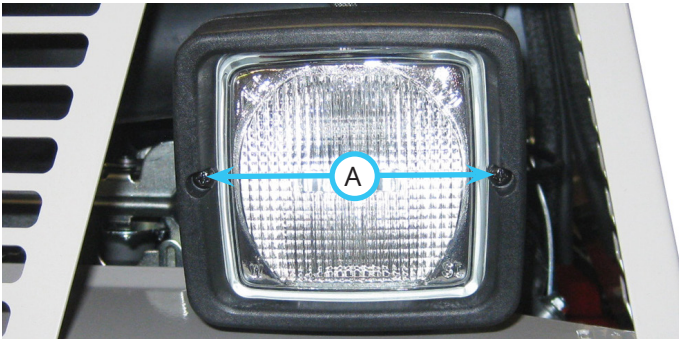

2. Disconnect the light bulb wire from the plug (B).

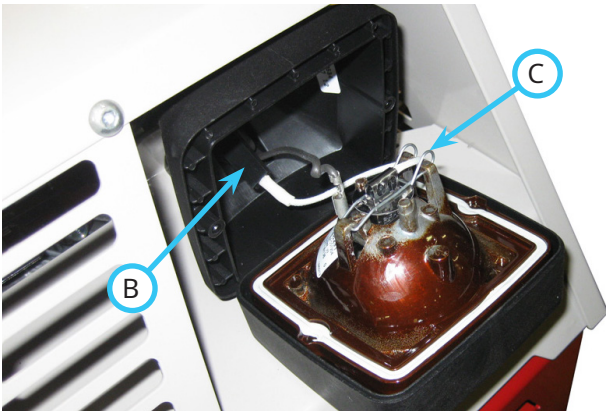

3. Pinch the wire spring fastener (C) and lift it away from the light bulb.
4. Remove the defective light bulb.
5. Install the new light bulb and secure with the wire spring fastener.
6. Connect the light bulb wire to the plug.
7. Reinstall the light cover.

Replacing the Work Lights (LED)

The work lights are equipped with LEDs and do not use a replaceable bulb. If a work light no longer functions, the entire work light must be replaced.

Replacing the Taillights

The taillights are equipped with LEDs and do not use a replaceable bulb. If a taillight no longer functions, the entire taillight must be replaced.

Replacing the Turn Signal Lights

The signal lights that are used for the turn signal / hazard flasher kit are equipped with LEDs and do not use a replaceable bulb. If a signal light no longer functions, the entire light must be replaced.

Replacing the Strobe Light Bulb (70.4114 Strobe Light Kit)

⚠ WARNING

High Voltage! Before removing the strobe light lens, turn off the power and wait five minutes to allow the capacitor to discharge.

1. Turn the battery disconnect switch to the Off position and wait five minutes for the capacitor to discharge.
2. Unscrew the strobe lens (A) from the base.
3. Hold the circuit board (B) in place with one hand and remove the strobe bulb (C).
4. Install the new strobe bulb, pushing it securely onto the circuit board connectors.
5. Ensure the circuit board and the O-ring are in place and reinstall the strobe lens.
6. Turn the battery disconnect switch to the On position.

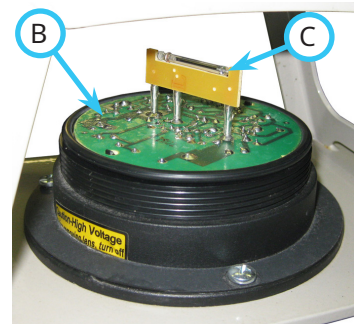
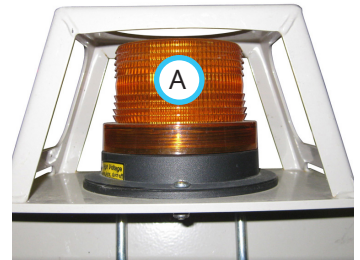

SERVICE

Replacing the Strobe Light (70.4155 Strobe Light Kit)

The strobe light in the 70.4155 strobe light kit does not use a replaceable bulb. If the strobe light no longer functions, the entire strobe light must be replaced.

Changing the Strobe Light Flasher Mode (70.4155 Strobe Light Kit)

1. Remove the four screws that fasten the strobe light to the strobe light frame.
2. Locate the yellow wire from the strobe light. This wire is used to cycle the strobe light modes.
3. Turn the ignition key to the On position to turn on accessory power.
4. Turn the strobe light switch to the On position.
5. Insert the bare end of the yellow wire into the back of the terminal on the red power supply wire. Each time you touch the yellow wire against the red wire, the strobe will change modes.
6. When the desired mode is reached, turn the strobe light switch to the Off position and turn the ignition key to the Off position.
7. Reinstall the strobe light back onto the strobe light frame.

PTO Belt Inspection

Inspecting the PTO belt of this power unit can prevent sudden belt failure by finding problems before they cause a belt to break. Inspect the PTO belt prior to operation, as part of the daily inspection or anytime a problem is suspected. There may be a PTO belt problem if there is a squealing or chattering sound, or the smell of a slipping belt.

Check the PTO belt (A) at the PTO idler pulley (B).

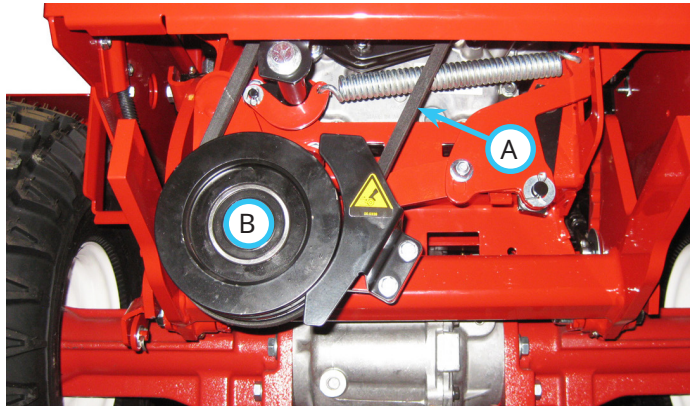

Typical wear on a drive belt may result in the conditions shown in the diagram. If any of these conditions occur, the drive belt will require replacement.

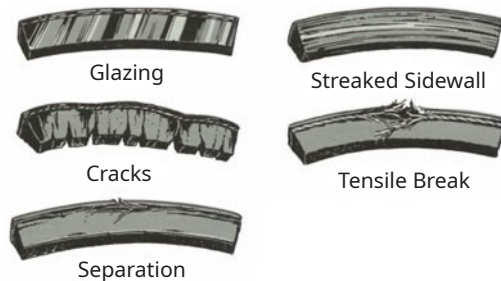

SERVICE

PTO Belt Tension Adjustment

1. Pull out on the PTO belt tensioner rod to release tension from the belt tensioner linkage.
2. Loosen the adjustment bolt (A) and rotate the tension adjustment link (B) clockwise to increase the tension applied to the PTO and attachment belts. Rotate the tension adjustment link counterclockwise to decrease the tension applied to the PTO and attachment belts.

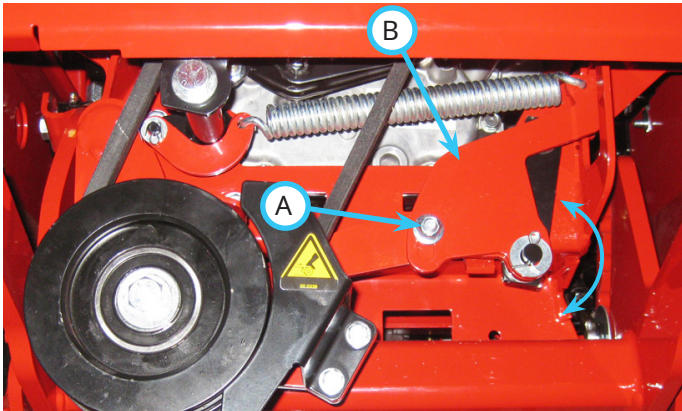

3. Tighten the adjustment bolt securely. Torque to 42 Nm (31 ft-lbs).

PTO Belt Replacement

1. If the power unit has been running, allow the engine to cool.
2. Remove the right engine cover.
3. Remove the PTO idler pulley guard (A).
4. Pull the PTO belt tensioner rod out to release the belt tension.

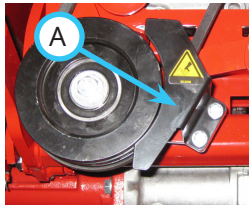

5. Remove the hairpin (B) and washer that fastens the belt tensioner rod to the belt tensioner rocker.

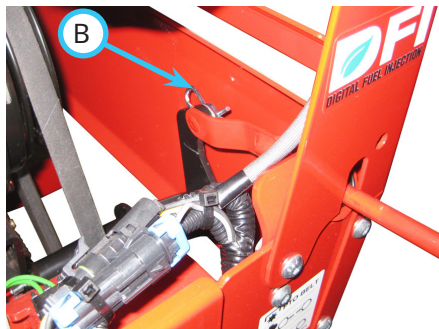

6. Remove the belt tensioner rod from the belt tensioner rocker.
7. Lift up on the PTO idler pulley and remove the belt from the pulley.
8. Pull the belt up between the PTO tension rocker and the front grill and remove from the clutch pulley. If necessary, rotate the PTO tension rocker to increase the gap between the rocker and the grill.
9. Push the new belt down between the PTO tension rocker and the front grill (it may be necessary to turn the belt sideways).
10. Install the belt onto the clutch pulley.
11. Lift up on the PTO idler pulley and install the belt into the rear groove of the idler pulley.
12. Reinstall the PTO belt tensioner rod to the belt tensioner rocker and fasten with the washer and hairpin.
13. Reinstall the PTO idler pulley guard. Torque the bolts to 11 Nm (100 in-lbs).
14. Reinstall the right engine cover.

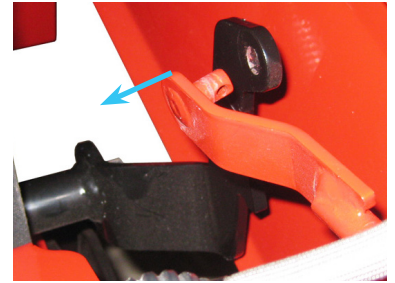

SERVICE

Clutch Air Gap Inspection and Adjustment

The electric clutch is activated by the PTO switch to engage or disengage power to belt driven attachments. The clutch also provides braking action to stop the attachment when the PTO is disengaged or the operator presence circuit is interrupted.

For proper operation, the air gap between the armature and the rotor must be set at .5 mm (.020 inch). If the air gap is too narrow, the clutch armature may drag when disengaged, causing premature failure. If the air gap is too wide, the clutch may not engage correctly or it may disengage when it becomes hot. Check the air gap annually and adjust the clutch air gap as needed.

1. Locate the three inspection windows (A) on the clutch.

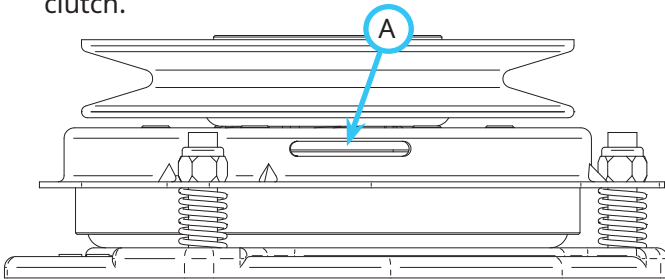

2. Insert a .5 mm (.020 inch) feeler gauge through the inspection window and into the slot between the armature and the rotor.
3. Tighten or loosen the clutch adjustment nut (B) as needed to achieve the .5 mm (.020 inch) air gap.

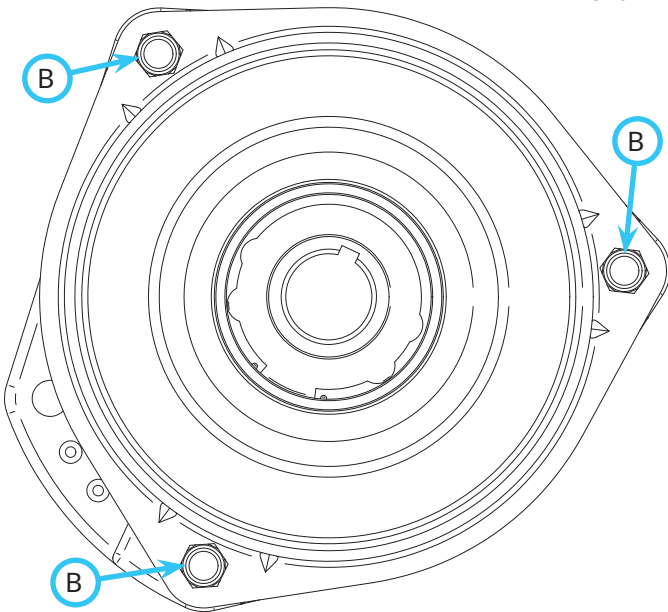

Wheel Removal and Installation

Wheel Removal:

1. Park the power unit on a level surface.
2. Loosen the wheel lug nuts, but do not remove.

⚠ WARNING

If the power unit is not adequately supported, the unit could fall and trap or crush a person or appendage, causing severe injury or death.

3. Lift up the corner of the power unit and secure with a jack stand.
4. Remove the lug nuts and lift the wheel off the mounting studs.

Wheel Installation:

1. Place the wheel onto the mounting studs with the hub side of the rim against the axle hub. NOTE: if the wheel is equipped with a single valve stem, the valve stem will be to the outside of the power unit. If the wheel is equipped with dual valve stems, there is a decal on the rim that indicates the hub side of the rim.
2. Install the lug nuts and tighten by hand until the wheel is held against the axle hub.
3. Lift the power unit up slightly and remove the jack stand. Lower the power unit to the ground.
4. Tighten the lug nuts in a crisscross sequence as shown. Torque to 75 Nm (55 ft-lbs).

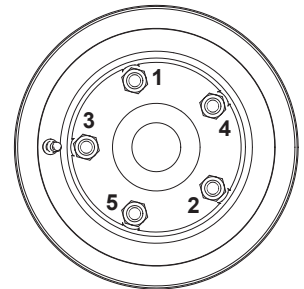

SERVICE

Outer Dual Wheel Removal and Installation

1. Raise the power unit approximately 5 cm (2 inches) by driving the power unit onto wood planks positioned in line with the inner wheels. The outer dual wheels should not contact the wood planks. A jack and jack stands may be used to raise and support the power unit if planks are not available.

⚠ WARNING

Place wheel chocks in front and back of the inner wheels to prevent the power unit from rolling forward or backward during removal or installation of the outer dual wheels.

2. Place wheel chocks in front and back of the inner wheels to prevent accidental movement.

Outer Dual Wheel Removal:

1. Loosen the draw bolts approximately five turns.
2. With a medium size hammer, hit the end of the draw bolt until the draw cone releases.
3. Remove the dual wheel assemblies by rotating them counterclockwise.
4. Install the four plastic plugs from the dual wheel kit into the inner dual wheel hubs.
5. If desired, move the steering cylinder to the inner hole setting of the cylinder mount under the left front corner of the foot platform. Torque to 203 Nm (150 ft-lbs).

Outer Dual Wheel Installation:

1. Remove the plastic plugs from the inner dual wheel hubs.
2. Inspect the threaded end of the dual wheel extensions to ensure the draw cone, the draw bolt, and the external threads of the dual wheel extension have a light coating of grease. Apply grease if necessary.
3. The draw cone must be loose before installing the dual wheel extension into the inner hub. Check by sliding the draw bolt in and out. It should have 6.5-13 mm (1/4-1/2 inch) of travel.

4. Insert the threaded end of the dual wheel extension into the inner dual wheel hub. Using both hands, turn the dual wheel clockwise until the wheel is tight and there are four threads or fewer visible on the outer wheel extension. This is to ensure the hubs lock correctly when the draw bolt is tightened. Repeat for the other three wheels.



After tightening the outer dual wheel, there should be four or fewer threads visible on the outer dual wheel extension.

5. Tighten the draw bolt and torque to 163 Nm (120 ft-lbs) Repeat for the other three wheels.
6. If the steering cylinder is mounted to the inner hole setting of the steering cylinder mount, move the steering cylinder to the center hole setting of the cylinder mount under the left front corner of the foot platform. Torque to 203 Nm (150 ft-lbs).

Tire Pressure

Keep tires evenly inflated. Keep tire pressures within the proper range to prevent premature wear and/or poor traction.

Tire	Single Wheel	Dual Wheels	
		Inner	Outer
All Terrain	55-110 kPa (8-16 psi)	55-69 kPa (8-10 psi)	41-55 kPa (6-8 psi)
Bar	55-110 kPa (8-16 psi)	55-69 kPa (8-10 psi)	41-55 kPa (6-8 psi)
Turf	103-138 kPa (15-20 psi)	103-117 kPa (15-17 psi)	69-83 kPa (10-12 psi)

SERVICE

ROPS and Seat Belt Inspection

⚠ WARNING

Failure to inspect and maintain the Roll-Over Protection System and the seat belt can lead to serious injury or death.

If any part of the ROPS sustains structural damage, the entire ROPS must be replaced.

1. Inspect the roll bar for damage, missing components, and loose or missing hardware. Replace any damaged or missing components and tighten loose hardware prior to operating the power unit.
2. Inspect the seat belt for cuts, abrasions, fraying, or excessive wear.
3. Inspect the seat belt for damage from exposure to the sun's ultraviolet rays. If the color of the seat belt is extremely faded, its physical strength may be deteriorated.
4. Inspect the seat belt for dust and dirt. If the seat belt is packed with dirt, its physical strength may be deteriorated.
5. Inspect the seat belt for stiffness. If the seat belt is no longer flexible, its physical strength may be deteriorated.
6. Inspect the seat belt buckle and latch for damage, cracks, or excessive wear.
7. Inspect the seat belt for proper operation. The seat belt should latch securely and release smoothly. Seat belt adjustment should be accomplished without excessive resistance.
8. If any problems are detected during this inspection, the component must be replaced prior to operating the power unit.

Parking Brake Inspection and Adjustment

The parking brake tension must be set to require a minimum of 7 kg (15 pounds) of force to engage the brake lever seven clicks or less from the off position. If less than 7 kg (15 pounds) is required to engage the brake lever seven clicks from the off position, or if engaging the parking brake will not prevent the power unit from moving, the brake linkage rod will need to be adjusted.

1. Park the power unit on a level surface.

⚠ WARNING

The parking brake must be disengaged as part of the adjustment procedure. Park the power unit on a level surface and place wheel chocks in front and back of the wheels to prevent the power unit from rolling forward or backward.

2. Place wheel chocks in front and back of the wheels to prevent accidental movement.
3. Disengage the parking brake to remove tension from the brake linkage.
4. Tighten the lock nut (A) on the brake linkage rod several turns and recheck the amount of force required to engage the brake lever. Continue to adjust the lock nut until there is a minimum of 7 kg (15 pounds) of force required to engage the brake lever seven clicks or less from the off position.

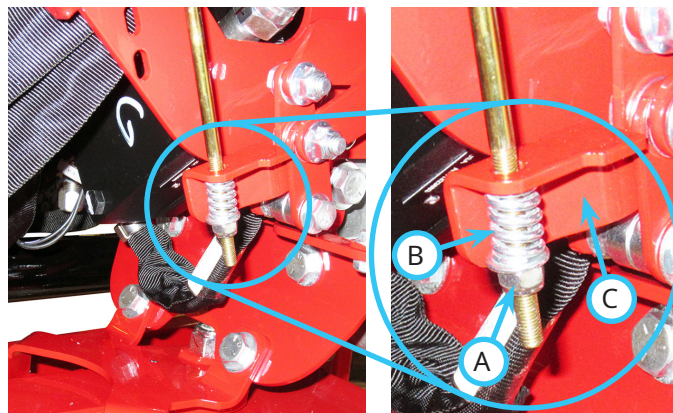

5. After the required amount of force to engage the parking brake is achieved, disengage the parking brake and move the SDLA lever forward to the end of its stroke. While moving the SDLA lever forward, observe the compression spring (B) and the brake engagement tab (C) on the brake linkage. The compression spring should not cause the brake engagement tab to be lifted up more than .8 mm (.03 inches). If the brake engagement tab movement exceeds the specified measurement, it is possible for the brake to drag when travelling at full forward speed, causing premature wear of the brake.

SERVICE

6. If it is not possible to achieve the required parking brake engagement force without causing the brake engagement tab to exceed its movement specification, the parking brake band may require further service. Contact an authorized Ventrac dealer for assistance.

Neutral Adjustment

The power unit should come to a complete stop with the neutral assist lever in the On position and the parking brake disengaged. The power unit should not attempt to move with the parking brake engaged. If the power unit is attempting to move, there will be an excessive amount of pump hydraulic noise, which indicates the pump is not in the neutral position.

If the power unit moves or attempts to move in either condition, the neutral position must be adjusted.

1. Remove any attachment from the power unit.
2. Park the power unit on a level surface.
3. Remove the pump cover from the power unit.

⚠ WARNING

Do not attempt to adjust the neutral position with the power unit wheels on the ground. The power unit could move forward or backward unexpectedly, causing severe injury or death.

If the power unit is not adequately supported, the unit could fall and trap or crush a person or appendage, causing severe injury or death.

4. Lift the power unit so that all four wheels are a minimum of 5 cm (2 inches) off the ground and secure the power unit with jack stands or supporting blocks. Ensure the jack stands or supporting blocks will not make contact with the wheels when they rotate.
5. Place a weight of 22.5 kg (50 pounds) on the seat so the operator presence switch is activated.
6. Place the neutral assist lever in the On position to engage the neutral assist spring.
7. Start the power unit and adjust the engine speed to approximately 2,000 RPM.

8. Locate the neutral adjustment bolt (A) on the lower right side of the front frame (right column panel), directly below the neutral

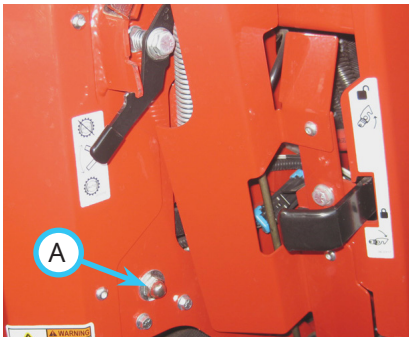

assist lever.

9. Loosen the neutral adjustment nut (A) slightly. NOTE: it is easier to attain the desired setting if the neutral adjustment nut is left snug and a rubber mallet or a piece of wood and a hammer are used to tap the nut in the desired direction. Do not strike the nut directly with a metal hammer, as it is possible to dent or damage the nut.
10. Release the parking brake and observe the direction the tires are rotating. If the tires are rotating in the forward direction, the neutral adjustment nut should be moved up in the frame slot. If the tires are rotating in the reverse direction, the neutral adjustment nut should be moved down in the frame slot.
11. Once the proper neutral position is achieved and the tires no longer rotate, tighten the neutral adjustment nut to 42 Nm (31 ft-lbs). Make sure to hold the bolt head to help prevent the bolt from moving in the frame slot while the nut is tightened.
12. Verify that the neutral position is still correct after tightening the nut by moving the SDLA lever in the forward and reverse directions and allowing the spring return to move the lever back to the neutral position. Observe the tires to see if there is any movement. Repeat steps 9-11 as needed until there is no movement of the tires.
13. Engage the parking brake and listen for abnormal amounts of pump hydraulic noise. Repeat steps 9-11 if necessary.
14. Engage the parking brake and shut off the engine.
15. Remove the weight from the power unit seat.
16. Remove the power unit from the jack stands or supporting blocks and return to the ground.

⚠ WARNING

An improperly adjusted neutral switch can result in erratic engine cranking or unsafe power unit movement. Check the neutral switch position after any adjustment is made to the neutral position.

17. Adjustments made to the neutral position bolt may affect the neutral switch setting. After changing the neutral setting, it is possible that the power unit will not start, due to the neutral switch being out of adjustment. Always refer to the Neutral Switch Adjustment section to check and adjust the neutral switch after any adjustment is made to the neutral position.

SERVICE

Neutral Switch Adjustment

⚠ WARNING

An improperly adjusted neutral switch can result in erratic engine cranking or unsafe power unit movement. Check the neutral switch position after any adjustment is made to the neutral position.

1. Park the power unit on a level surface.

⚠ WARNING

The parking brake must be disengaged as part of the adjustment procedure. Park the power unit on a level surface and place wheel chocks in front and back of the wheels to prevent the power unit from rolling forward or backward.

2. Place wheel chocks in front and back of the wheels to prevent accidental movement.
3. Remove the pump cover from the power unit.
4. Disengage the parking brake.
5. Turn the ignition key to the Run position to activate the electrical system, but do not start the engine.

6. Locate the tractor control module (TCM) under the power unit's hood. The neutral switch input light (A) will be used as an indicator for when the neutral switch is on or off.

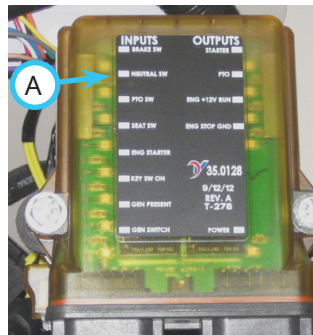

7. Measure and record the distance between the front frame (B) and the pump arm (C).
8. Move the SDLA lever slowly in the forward direction while watching the neutral switch input light. When the light turns off, stop the SDLA lever and measure the distance between the front frame and the pump arm. This measurement should be a minimum of .8 mm (1/32 inch) less and a maximum of 1.6 mm (1/16 inch)

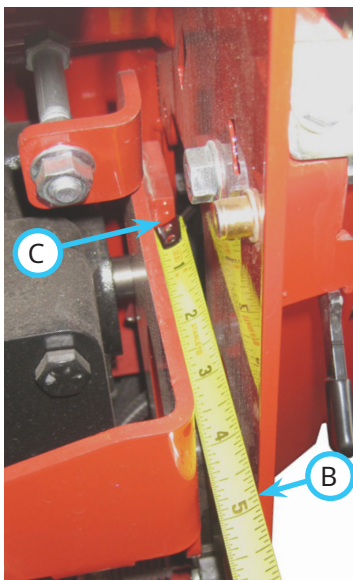

less than the measurement taken when the SDLA lever was at the neutral position. (e.g., if the original measurement was 101.6 mm (4 inches) the measurement when the neutral switch input light turns off must be between 100.8 mm (3-31/32 inch) and 100 mm (3-15/16 inch). NOTE: it is helpful to have an assistant to take the measurements.

9. If the measurement is not within the specified range, adjust the neutral switch mount (D) by loosening the two mounting bolts and sliding the mount in the necessary direction. Tighten the switch mount hardware to 11 Nm (100 in-lbs).
10. Repeat steps 8 and 9 as needed until the measurement is within the specified range.
11. Turn the ignition key to the off position.
12. Engage the parking brake.
13. Reinstall the pump cover.
14. Remove the wheel chocks.
15. If you are unsure of the correct procedure to adjust the neutral switch, or if you are unable to attain the correct setting, contact an authorized Ventrac dealer for assistance.



SERVICE

Storage

Preparing the Power Unit for Storage

1. Clean the power unit.

ATTENTION

To maintain the finish of the power unit, thoroughly wash the equipment to remove any corrosive agents (e.g., salt). Failure to clean the equipment may result in corrosion of (including but not limited to) steel, aluminum, and electrical components.

2. Inspect for loose or missing hardware, damaged components, or signs of wear. Repair or replace any damaged or worn components.
3. Inspect the ROPS structure and seat belt for signs of damage or wear.
4. Inspect the safety decals. Replace any decals that are faded, illegible, or missing.
5. Inspect the hydraulic hoses and fittings for leaks and/or wear. Service as required.
6. Inspect the fuel lines for leaks.
7. Perform the parking brake inspection.
8. Inspect the electrical system and connections.
9. Test the operator safety interlock system.
10. Perform a TCM (tractor control module) check to ensure the inputs and outputs are correct. Refer to the Troubleshooting chapter for input and output information.
11. Inspect the PTO pulley and belt for damage or excessive wear. Service as required.
12. Perform the PTO clutch air gap inspection.
13. Check the hydraulic oil level. Add fluid or service as required.
14. Clean the engine compartment, the engine, and the engine oil cooler.
15. Check the tires for proper inflation.
16. Grease or lubricate all points specified in the Lubrication section. Wipe off any excess grease or oil.
17. Inspect the painted components for chips, scratches, or rust. Clean and touch up the surfaces as needed.

After all the above steps have been performed, complete the preparation for storage by performing the steps for either long term storage (four months or longer) or short term storage (less than four months).

Long Term Storage (four months or longer)

1. Change the engine oil to prevent damage that can be caused by acidic buildup in used motor oil.
2. Drain all the fuel out of the fuel tank, start the power unit's engine, and allow to run until the engine stops to ensure all the fuel is out of the fuel lines, carburetor passages, injectors, etc.
3. Turn the key to the Off position and remove the ignition key.
4. Engage the parking brake.
5. Turn the fuel shut-off valve to the Off position.
6. Turn the battery disconnect to the Off position.
7. If the power unit is being stored in a cold climate (below 2° C [35° F]), remove the battery from the power unit and store in a warm location. Check the battery charge periodically and charge the battery, if needed.

Short Term Storage (less than four months)

1. Add a quality gasoline fuel stabilizer to the fuel tank. Follow the manufacturer's recommended mixing ratios.
2. Start the power unit's engine and run for ten minutes to allow the fuel stabilizer to travel all through the fuel system.
3. Shut off the engine and remove the ignition key.
4. Engage the parking brake.
5. Turn the fuel shut-off valve to the Off position.
6. Turn the battery disconnect to the Off position.
7. Check the battery charge periodically and charge the battery, if needed.

SERVICE

Removing the Power Unit from Storage

1. Clean the power unit to remove any accumulated dust or debris.
2. Inspect the power unit as instructed in the Daily Inspection section of this manual.
3. Test the power unit to ensure that all the components and systems are working properly.

SERVICE

Maintenance Schedule

Maintenance Schedule	# of locations	# of pumps	As Needed	After First 8 Hrs.	Daily	At 50 hours	At 100 hours	At 150 hours	At 200 hours	At 250 hours	At 300 hours	At 350 hours	At 400 hours	At 450 hours	At 500 hours	At 550 hours	At 600 hours	At 650 hours	At 700 hours	At 750 hours	At 800 hours	At 850 hours	At 900 hours	At 950 hours	At 1,000 hours	Yearly	1,500 Hours*	
Grease and Lubrication: Refer to the Lubrication Section																												
Front Hitch	2	1	✓			✓	✓	✓	✓	✓	✓	✓	✓	✓	✓	✓	✓	✓	✓	✓	✓	✓	✓	✓	✓	✓		
Lift Cylinder	2	1	✓			✓	✓	✓	✓	✓	✓	✓	✓	✓	✓	✓	✓	✓	✓	✓	✓	✓	✓	✓	✓	✓		
Center Pivot	1	1	✓			✓	✓	✓	✓	✓	✓	✓	✓	✓	✓	✓	✓	✓	✓	✓	✓	✓	✓	✓	✓	✓		
Steering Cylinder	2	1	✓			✓	✓	✓	✓	✓	✓	✓	✓	✓	✓	✓	✓	✓	✓	✓	✓	✓	✓	✓	✓	✓		
Drive Shaft	2	1	✓			✓	✓	✓	✓	✓	✓	✓	✓	✓	✓	✓	✓	✓	✓	✓	✓	✓	✓	✓	✓	✓		
3 Point Cylinder (if equipped)	2	1	✓			✓	✓	✓	✓	✓	✓	✓	✓	✓	✓	✓	✓	✓	✓	✓	✓	✓	✓	✓	✓	✓		
3 Point Hitch Pivot (if equipped)	2	1	✓			✓	✓	✓	✓	✓	✓	✓	✓	✓	✓	✓	✓	✓	✓	✓	✓	✓	✓	✓	✓	✓		
Lower Connector Link	2	1	✓			✓	✓	✓	✓	✓	✓	✓	✓	✓	✓	✓	✓	✓	✓	✓	✓	✓	✓	✓	✓	✓		
Seat Slide	2	#	✓			✓	✓	✓	✓	✓	✓	✓	✓	✓	✓	✓	✓	✓	✓	✓	✓	✓	✓	✓	✓	✓		
Engine ¹																												
Check the Engine Oil Level					✓																							
Change the Engine Oil and Filter ¹				✓		✓		✓		✓		✓		✓		✓		✓		✓		✓		✓		✓		
Clean or Replace the Spark Plugs	Consult the engine owner's manual*																											
Inspect the Primary Air Filter				✓																								
Replace the Primary Air Filter	**					**	✓	**	✓	**	✓	**	✓	**	✓	**	✓	**	✓	**	✓	**	✓	**	✓	**	✓	
Replace the Safety Air Filter													✓									✓						
Clean around the carburetor and linkage	**		✓	✓	✓	✓	✓	✓	✓	✓	✓	✓	✓	✓	✓	✓	✓	✓	✓	✓	✓	✓	✓	✓	✓	✓	✓	
Check the Valve Clearance	**								✓						✓											✓		
Remove the cylinder head covers and clean the cylinder heads	**														✓											✓	✓	
Clean the Engine, the Engine Compartment, the Rotating Screen, and the Engine Oil Cooler	**		✓																									
Replace the Fuel Filter	✓												✓															
Drain Water and Sediment from Fuel Tank	✓																										✓	
Hydraulic System																												
Check the Hydraulic Oil Level				✓																								
Check the Rear Transaxle Oil Level										✓					✓							✓					✓	✓
Change the Hydraulic Filters ^{**}						✓									✓													✓
Change the Hydraulic Oil and the Rear Transaxle Oil															✓													✓
Parking Brake																												
Parking Brake Inspection and Adjustment				✓																								
Electrical																												
Clean the Battery Terminals and Compartment	✓																											✓
Inspection																												
Inspect the Operator Interlock System				✓																								
Inspect the ROPS Structure and Seat Belt				✓																								
Inspect for Loose, Missing, or Worn Components				✓																								
Inspect the Battery, Electrical Connections, and Lights				✓																								
Inspect the Belts, Fuel Lines, and Hydraulic Lines				✓																								
Check the Tire Pressure				✓																								
Check the Wheel Lug Nuts. Torque to 75 Nm (55 ft-lbs)					✓	✓	✓	✓	✓	✓	✓	✓	✓	✓	✓	✓	✓	✓	✓	✓	✓	✓	✓	✓	✓	✓	✓	✓
Check the Steering Cylinder Bolts. Torque to 203 Nm (150 ft-lbs)							✓		✓		✓		✓		✓		✓		✓		✓		✓		✓		✓	
Check the Front/Rear Connector Link Bolts. Torque to 203 Nm (150 ft-lbs)							✓		✓		✓		✓		✓		✓		✓		✓		✓		✓		✓	
Check the Front Hitch Pivot Bolts. Torque to 203 Nm (150 ft-lbs)							✓		✓		✓		✓		✓		✓		✓		✓		✓		✓		✓	
*Follow service intervals for heavy loads and high temperatures. If unspecified, service at one-half the standard service interval.																												
**Operation in severe conditions may require more frequent service intervals.																												
¹ Consult the Engine Owner's Manual for engine oil information and complete servicing information.																												
[#] Silicon Based Spray Lubricant																												
[%] Hydraulic filters initial change at 100 hours. Change the hydraulic oil and filters at 500 hours, then every 1,000 hours.																												

SERVICE

Maintenance Checklist

Maintenance Checklist	# of locations	# of pumps	As Needed	After First 50 Hrs.	Daily	At 50 hours	At 100 hours	At 150 hours	At 200 hours	At 250 hours	At 300 hours	At 350 hours	At 400 hours	At 450 hours	At 500 hours	At 550 hours	At 600 hours	At 650 hours	At 700 hours	At 750 hours	At 800 hours	At 850 hours	At 900 hours	At 950 hours	At 1,000 hours	Yearly	1,500 Hours*
Grease and Lubrication: Refer to the Lubrication Section																											
Front Hitch	2	1																									
Lift Cylinder	2	1																									
Center Pivot	1	1																									
Steering Cylinder	2	1																									
Drive Shaft	2	1																									
3 Point Cylinder (if equipped)	2	1																									
3 Point Hitch Pivot (if equipped)	2	1																									
Lower Connector Link	2	1																									
Seat Slide	2	#																									
Engine¹																											
Check the Engine Oil Level																											
Change the Engine Oil and Filter ¹																											
Clean or Replace the Spark Plugs																											
Inspect the Primary Air Filter																											
Replace the Primary Air Filter																											
Replace the Safety Air Filter																											
Clean around the carburetor and linkage																											
Check the Valve Clearance																											
Remove the cylinder head covers and clean the cylinder heads																											
Clean the Engine, the Engine Compartment, the Rotating Screen, and the Engine Oil Cooler																											
Replace the Fuel Filter																											
Drain Water and Sediment from Fuel Tank																											
Hydraulic System																											
Check the Hydraulic Oil Level																											
Check the Rear Transaxle Oil Level																											
Change the Hydraulic Filters ^{**}																											
Change the Hydraulic Oil and the Rear Transaxle Oil																											
Parking Brake																											
Parking Brake Inspection and Adjustment																											
Electrical																											
Clean the Battery Terminals and Compartment																										✓	
Inspection																											
Inspect the Operator Interlock System																											
Inspect the ROPS Structure and Seat Belt																											
Inspect for Loose, Missing, or Worn Components																											
Inspect the Battery, Electrical Connections, and Lights																											
Inspect the Belts, Fuel Lines, and Hydraulic Lines																											
Check the Tire Pressure																											
Check the Wheel Lug Nuts. Torque to 75 Nm (55 ft-lbs)																											
Check the Steering Cylinder Bolts. Torque to 203 Nm (150 ft-lbs)																											
Check the Front/Rear Connector Link Bolts. Torque to 203 Nm (150 ft-lbs)																											
Check the Front Hitch Pivot Bolts. Torque to 203 Nm (150 ft-lbs)																											
*Follow service intervals for heavy loads and high temperatures. If unspecified, service at one-half the standard service interval.																											
**Operation in severe conditions may require more frequent service intervals.																											
¹ Consult the Engine Owner's Manual for engine oil information and complete servicing information.																											
[#] Silicon Based Spray Lubricant																											
[*] Hydraulic filters initial change at 100 hours. Change the hydraulic oil and filters at 500 hours, then every 1,000 hours.																											

SERVICE

Maintenance Log

Date:	Hours:	Description of Repairs/Service	Initials

TROUBLESHOOTING

Electrical Troubleshooting Using the Tractor Control Module (TCM)

The TCM monitors the electronic circuits necessary for the engine, the starter, and the PTO to function. These input circuits include the PTO switch, the neutral switch, the parking brake switch, the ignition switch, and the generator presence. The TCM is programmed to allow the engine, the starter, and the PTO to operate only when specific input criteria are satisfied. The engine, the starter, and the PTO circuits are controlled by outputs from the TCM.

For troubleshooting purposes, the TCM includes red LED lights for each circuit. The LED lights will activate when the input or output circuit is activated. The TCM is divided into two sections: the left (input) side displays the eight inputs with red LED lights and the right (output) side displays the five outputs, also with red LED lights. The TCM has two power supplies. The first supplies power to the computer independent of the ignition switch so that the TCM does not turn on and off with each ignition switch cycle. (NOTE: when the battery disconnect switch is turned off, the TCM is also turned off). The second supply energizes the rest of the computer when the ignition switch is turned on.

When the battery disconnect switch is turned on, the Power LED light (J) will illuminate. If the system voltage drops below a preset value when the ignition switch is off, or if the power unit sits unused for more than fifteen days, the TCM will automatically go into Sleep mode and enter a reduced power state. To wake the TCM, turn the battery disconnect switch off for ten seconds and then turn back on.

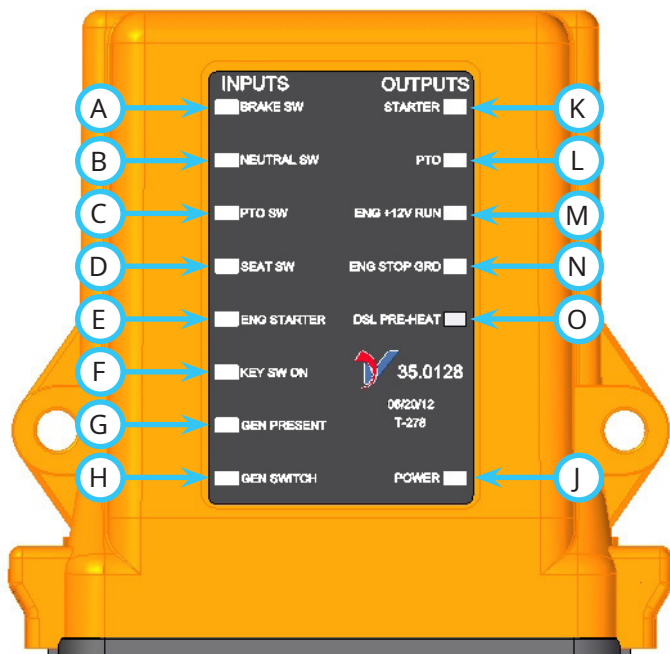

Input Circuits

Brake Switch (A)

The light indicates the circuit is closed and the parking brake is engaged. In order for this light to operate, the key must be turned to the run position.

Neutral Switch (B)

The light indicates the circuit is closed and the power unit's SDLA control lever is in neutral. In order for this light to operate, the key must be turned to the run position and the SDLA lever must be in the neutral position.

PTO Switch (C)

The light indicates the PTO switch is in the On position. In order for this light to operate, the key must be turned to the run position and the PTO switch must be in the On (engaged) position.

Seat Switch (D)

The light indicates that an operator is present in the seat. In order for this light to operate, the key must be turned to the run position and the operator must be present in the seat.

Engine Starter (E)

The light indicates that the key is turned to the start position.

Key Switch On (F)

The light indicates that the key is turned to the run (on) position. The key must be turned to the run position for the TCM to activate.

Generator Present (G)

The light indicates that the generator is connected to the power unit, which activates a specific set of criteria and allows the PTO to operate without an operator present on the seat. In order for this light to operate, the key must be turned to the run position and a generator must be connected to the power unit.

Generator Switch (H)

The light indicates that the switch on the generator is set to the On (engaged) position. In order for this light to operate, the key must be turned to the run position, a generator must be connected to the power unit, and the switch on the generator must be pulled up to the On position.

TROUBLESHOOTING

Power (J)

This light is located at the bottom right corner of the TCM. This light indicates that there is full time power to the TCM and is only shut off by the battery disconnect switch or if the TCM enters the Sleep mode. It keeps the TCM computer energized to eliminate the delay that would otherwise be present when the key is first turned to the run position.

Output Circuits

Specific input conditions must be satisfied before each output circuit can function.

Starter (K)

The light indicates that power is being sent to the starter solenoid. For the starter output to function, the parking brake must be engaged and the SDLA control lever must be in neutral.

PTO (L)

The light indicates that power is being sent to the PTO clutch relay. For the PTO output to function, the operator must be on the seat.

If the PTO remote kit is installed and an attachment such as the generator is connected, the TCM will automatically enable the Remote PTO function. In this mode, the PTO switch on the attachment replaces the seat switch criteria for the PTO to function. The parking brake must be engaged for the Remote PTO to function.

The following engine commands are engine specific.

Engine + 12V Run (M)

Not applicable for this engine/model.

Engine Stop Ground (N)

In order for this engine to run, the engine stop ground must be open. To shut off the engine, the engine stop ground must be closed.

This light indicates the engine stop ground is open, allowing the engine to run.

















Diesel Pre-Heat (O)

Not applicable for this engine/model.

TROUBLESHOOTING

Electrical Troubleshooting Guide

1. Always ensure that there is power supplied to the computer (TCM). With the key turned to the off position, check to ensure the LED light for the power input (J) is turned on. If the light is not on:
 - a. Check the battery disconnect switch to ensure that it is turned on.
 - b. If the battery disconnect switch was already turned on, the TCM may be in Sleep mode. Turn the battery disconnect switch off for ten seconds and then turn back on to wake the TCM.
 - c. Check the 15 amp fuse in slot number 10 of the front fuse panel. Replace this fuse, if necessary.
2. Turn the key to the run position and check to see if any other lights turn on. If no other lights turn on, check the 5 amp fuse in slot number 8 of the front fuse panel. Replace this fuse, if necessary. If any other lights turn on, you can begin troubleshooting the rest of the TCM functions.
3. To troubleshoot the circuits in the chart below, the corresponding LED lights must be On for the circuit to function. If any required LED lights are not on, refer to the troubleshooting section in the following pages.

Circuit	Power	Brake Switch	Neutral Switch	PTO Switch	Seat Switch	Engine Starter	Key Switch	Generator Present	Generator Switch
Starter									
PTO									
PTO w/Generator									
Engine Stop Ground									

TROUBLESHOOTING

Engine

Symptom:	Possible Cause:
The starter will not engage.	The battery disconnect switch is in the Off position. The Tractor Control Module (TCM) is in Sleep mode. A blown fuse in the power relay module. A blown fuse in the start circuit. The parking brake is not engaged. The parking brake switch is out of adjustment. The power unit is not in neutral. The neutral switch is out of adjustment. Low battery voltage.
The engine cranks, but won't start.	The fuel shut-off valve is turned off. The fuel tank is empty. A faulty fuel pump. A plugged fuel filter. A blockage in the fuel line. Poor engine compression.
The engine runs rough.	Plugged or partially plugged air filter(s). Plugged or partially plugged fuel filter. Stale, dirty fuel or wrong seasonal fuel mixture. The fuel level is low. Faulty spark plugs. Moisture in the spark plug pockets. Incorrect choke setting. A faulty fuel pump. Dirty or faulty fuel injectors. Incorrect valve clearance. Valve seat failure.
The engine is low on power.	Plugged or partially plugged air filter(s). Plugged or partially plugged fuel filter. Dirty or faulty carburetor. Low cylinder compression.
The engine overheats.	The engine compartment has debris buildup.
The oil light comes on when the engine is running.	The oil level is low. A faulty oil sender. A faulty or plugged oil pump.

TROUBLESHOOTING

Engine (Continued)

Symptom:	Possible Cause:
The engine uses excessive fuel.	Plugged or restricted air filters or air intake hoses. Dirty or faulty fuel injectors.
The engine uses excessive oil.	The engine has an oil leak. The oil is an incorrect viscosity. Plugged or restricted air filters or air intake hoses. The engine has worn rings or cylinder walls. The engine has worn or faulty valves.

Electrical

Anytime there is an electrical issue, first check to ensure the LED light for the Power input (bottom right corner) of the TCM is turned on when the key is in the off position. If the light is not on:

- Check the battery disconnect switch to ensure that it is turned on.
- If the battery disconnect switch was already turned on, the TCM may be in Sleep mode. Turn the battery disconnect switch off for ten seconds and then turn back on to wake the TCM.
- Check the 15 amp fuse in slot number 10 of the front fuse panel. Replace this fuse, if necessary.

Next, turn the key to the run position and check to see if any of the other lights turn on. If no other lights turn on, check the 5 amp fuse in slot number 8 of the front fuse panel. Replace this fuse, if necessary. If any other lights turn on, you can begin troubleshooting the rest of the TCM functions.

Symptom:	Possible Cause:
The battery does not charge.	Loose or corroded battery connections. A broken or loose wire in the charge system. The battery is defective. A faulty regulator. A faulty alternator.
The lights do not activate.	A blown fuse. A blown light bulb. A broken wire. A faulty light switch.

TROUBLESHOOTING

Electrical (Continued)

Symptom:	Possible Cause:
The PTO does not engage.	A blown fuse. A faulty seat switch (operator must be on seat). A faulty PTO switch. PTO belt failure. The PTO clutch air gap is out of adjustment. A faulty clutch.
All the TCM lights are on, even with the key turned off.	Low battery voltage.

Hydraulic

Symptom:	Possible Cause:
The front attachment does not lift.	The hydraulic oil level is low. An excessive load on the front lift. The hydraulic oil suction filter is plugged. A faulty hydraulic lift cylinder. The pump charge pressure is low. Missing hardware on the lift cylinder. Missing hardware on the SDLA lever links.
Steering is difficult.	The hydraulic oil level is low. The hydraulic oil suction filter is plugged. A faulty steering cylinder. The pump charge pressure is low. An excessive load on the hydraulic system.
Excessive noise in the hydraulic system.	The hydraulic oil level is low. The hydraulic oil suction filter is plugged. Incorrect oil used in the hydraulic system. Cold weather - allow the power unit to warm up.
The hydraulic system overheats.	The circuit breaker for the hydraulic cooling fan is tripped. The hydraulic cooler is dirty/plugged . A faulty hydraulic cooling fan temperature sender. A faulty hydraulic cooling fan. The hydraulic system is overstressed (using high range instead of low range for heavy work loads).

TROUBLESHOOTING

Power Unit

Symptom:	Possible Cause:
The power unit will not move with the engine running.	The high/low shift lever is in the neutral position. The hydraulic oil level is low. The parking brake is not disengaging. The pump control arm connecting linkage is loose or disconnected. The tow valve is bypassing at the hydraulic pump. The universal joint at the engine/hydraulic pump is loose. A faulty hydraulic pump or motor.
The engine stalls whenever the SDLA control lever is moved forward or backward out of neutral.	The parking brake switch or the neutral switch is out of adjustment.

SPECIFICATIONS

Engine

Model	4500K
Manufacturer	Vanguard
Model Number	543479
Type	Gasoline
Cylinders.	2
Displacement	896 cc
Engine Gross Power	23.1 kW (31 hp)
Operating Range (RPM)	1,550-3,650
Cooling System	Air Cooled
Alternator	50 Amp

Electrical

Battery	500 Cold Cranking Amps
Voltage.	12 Volts

Power Train

Type	Hydrostatic (All Wheel Drive)
Hydrostatic Transaxle (2)	Peerless
Forward Speed (High)*.	16.1 km/h (10 mph)
Forward Speed (Low)*	8.4 km/h (5.2 mph)
Brakes	Hydro-Dynamic
Hydraulic Oil Filtration	10 Micron and 25 Micron

Controls and Instrument Panel

Steering	Power
PTO (Power Take Off).	Electric w/brake
Throttle Control.	Cable
Directional Control	Speed, Direction, Lift, Auxiliary (SDLA)
Control Orientation	Hand
Gauges.	Tachometer, Volt, Water Temperature, Fuel, Speedometer
Parking/Emergency Brake.	Band Brake

Other Features

Turning Radius	99 cm (39 inches)
Standard Tires	All Terrain (22 x 12-8) (56 x 30-20 cm)
Optional Tires.	Turf (22 x 11-10)(56 x 28-26 cm)
Optional Tires.	Bar (21 x 11-8)(53 x 28-20 cm)
Headlight	Halogen (55 watt)
Attachment System	Ventrac Mount

*May vary based on the tire size, type, and inflation.

SPECIFICATIONS

Dimensions

Wheelbase.114 cm (45 inches)
Overall Length208 cm (82 inches)
Overall Height (top of ROPS bar)170 cm (67 inches)
Overall Width (single tires)*.122 cm (48 inches)
Overall Width (dual tires)*.185 cm (73 inches)
Weight**	610-760 kg (1,340-1,680 pounds)

Venture Products, Inc. reserves the right to change these specifications without notice.

*May vary based on the tire size, type, and inflation.

**Weight varies based on the engine size, tire options, and optional accessories.

Fluid Capacities and Specifications

	Fluid Type	Capacity	Filter #1	Filter #2
Engine Oil	Synthetic 10W-30%	2.3 liters (2.4 quarts)	13.842921	
Hydraulic Oil (Front trans-axle and Reservoir)	HydroTorq XL Synthetic Hydraulic Oil	11.5 liters (12.1 quarts) Optional 3-point hitch 12.1 liters (12.8 quarts)	21.0122 (Suction filter)	21.0124 (Return filter)
Hydraulic Oil (Rear trans-axle)	HydroTorq XL Synthetic Hydraulic Oil	4.4 liters (4.6 quarts)	-	-
Fuel System	Unleaded Gasoline (Max 10% Ethanol)	22.7 liters (6 gallons)	13.691035	-
Grease	Lithium Complex NLGI #2	Refer to the Maintenance Chart	-	-

% = Use API Classification CI or higher. For optimal engine life and performance, use Ventrac full synthetic engine oil (Part Number 15.0037-1).

Visit ventrac.com/manuals
for the latest version of this operator's manual.
A downloadable parts manual is also available.



SPECIFICATIONS

Amperage Draw Chart

Stock Code	Component Description	Amperage
	4500K Tractor (General Amp Draw)	1.9
	Fuel Pump	1.4
	Lights	9.2
37.0060	PTO Clutch	6.1
21.0121	Hydraulic Cooler Fan	4.8

Options

70.4113	Halogen Work Light Kit	9.2
70.4133	LED Work Light Kit	2.6
70.4114	Strobe Light Kit	0.2
70.4155	Strobe Light Kit	0.35
70.4119	Directional / Hazard Signal Kit	0.6
70.4156	ECE Directional / Hazard Signal Kit	2.0
70.4104	12 Volt Front Kit	Attachment Dependent
70.4105	12 Volt Rear Kit	Attachment Dependent
70.4112	Slope Indicator Kit	0.1
70.4140	Slope Indicator Kit	0.5
70.4101	Back-up Alarm Kit	0.0

Weather Cab

70.2009	KW450 Weather Cab (work lights on, windshield wiper on)	7.1
70.2005-2	Directional Signal / Flasher Kit	8.0
70.2006-3	Strobe Light Kit	0.2
70.2006-6	Defrost Fan Kit	2.0 / 3.1
70.2014	KW452 Weather Cab (work lights on, windshield wiper on)	8.9
70.2006-6	Defrost Fan Kit	2.0 / 3.1
70.8148	Windshield Washer Kit	4.0
70.8161	Strobe Light Kit	0.35
70.8162	Hazard Light Kit	0.88

Attachments

70.8015	EA Seeder Kit (for EA600 AeraVator)	5.3
70.8025	12 Volt Actuator Kit (HB580 Broom, KX523 Snow Blower)	0.8
23.0136-1	Directional Control Valve (KV550, KV552)	1.8
70.8035	Height Adjust Cylinder Kit (KR502, KR702)	3.6
39.55500	ES220 Spyker Spreader	8.0
70.2010	SS575 Salt Spreader	5.0
70.8120	SS575 Vibrator Kit	8.2
70.2013	SA250 Drop Spreader	12.0
39.55170	MA900 Boom Mower	10.8

SPECIFICATIONS

Belt Chart

4500 Power Unit	Belt Size	Ventrac Part Number
4500 PTO Belt (Clutch to PTO Idler Pulley)	B38 belt	81.B038

Attachment Model	Belt Size	Ventrac Part Number
EA600 AeraVator	B50 belt	81.B050
ED200/202 Edger (with blower)	B45 belt	81.B045
ET200 Turbine Blower	B46 belt	81.B046
HB580 Broom	B48 belt	81.B048
HM602 Mower	B45 belt	81.B045
HM722 Mower	B45 belt	81.B045
HP722 Mower	B45 belt	81.B045
HQ680 Tough Cut Mower	B45 belt	81.B045
KA160 Power Blower	B52 belt	81.B052
KC180 Stump Grinder	B53 belt	81.B053
KH500 Versa-Loader	B33 Belt	81.B033
KJ520 Broom	B51 Belt	81.B051
KL480 Tiller	B66 belt	81.B066
KP540 Power Rake	B48 belt	81.B048
KX480 Snow Blower	B50 belt	81.B050
KX523 Snow Blower	B50 belt	81.B050
KY400 Trencher	B53 belt	81.B053
MA900 Boom Mower	B49 belt	81.B049
MC600 Rear Discharge Mower	B47 belt	81.B047
MJ840 Contour Mower	B45 belt	81.B045
MK960 Wide Area Mower	B45 belt	81.B045
MR740 Reel Mower	B47 belt	81.B047
MS600 Mower	B45 belt	81.B045
MS720 Mower	B45 belt	81.B045
MT720 Offset Mower	B45 belt	81.B045
MU720 Rear Discharge Mower	B45 belt	81.B045

WARRANTY



LIMITED WARRANTY - VENTRAC COMMERCIAL EQUIPMENT

Venture Products, Inc., (henceforth referred to as V.P.I.) warrants on the terms and conditions herein, that it will repair, replace, or adjust any part manufactured by Venture Products Inc., and found by Venture Products, Inc., to be defective in material and/or workmanship during the applicable warranty term.

All Ventrac commercial equipment purchased and registered on or after January 1, 2019 will carry a 2-year commercial warranty. The warranty period begins on the date of the original customer purchase:

Ventrac Commercial Equipment	Warranty Term
2100 SSV & Attachments	2-year
3000 Series Tractors & Attachments	2-year
4000 Series Tractors & Attachments	2-year

All Ventrac add-on kits and accessories such as: 3-point hitch, 12V front & rear power outlets, foot pedal, dual wheel kit, etc., will be covered under the above warranty periods provided they are installed by an Authorized Ventrac Dealer. This warranty may be transferred and will carry the remainder of the warranty starting from the original purchase/registration date with the dealership and/or V.P.I.

The engine warranty is covered by its respective engine manufacturer. Please refer to the engine manufacturer's warranty statement that is included in the owner's manual.

For warranty consideration on Ventrac commercial equipment, the equipment, including any defective part, must be returned to an Authorized Ventrac Dealer within the warranty period. The warranty shall extend to the cost to repair or replace (as determined by V.P.I.) the defective part. The expense of pickup and delivery of the equipment, the service call drive time or any transportation expense incurred for the warranty repair is the sole responsibility of the owner and is not covered under warranty by Ventrac and/or V.P.I. Ventrac and V.P.I.'s responsibility in respect to claims is limited to making the required repairs or replacements, and no claim of breach of warranty shall be cause for cancellation or rescission of the contract of sale of any Ventrac equipment. Proof of purchase may be required by the dealer to substantiate any warranty claim. Only warranty work performed and submitted by an Authorized Ventrac Dealer may be eligible for warranty credit.

This warranty extends only to Ventrac commercial equipment operated under normal conditions and properly serviced and maintained. The warranty expressly does NOT cover: (a) any defects, damage or deterioration due to normal use, wear and tear, or exposure; (b) normal maintenance services, such as cleaning, lubrication, oil change; (c) replacement of service items, such as oil, lubricants, spark plugs, belts, rubber hoses, bearings or other items subject to normal service replacement; (d) damage or defects arising out of, or relating to abuse, misuse, neglect, alteration, negligence or accident; (e) repair or replacement arising from operation of, or use of the equipment which is not in accordance with the operating instructions as specified in the operator's manual or other operational instructions provided by V.P.I.; (f) repair or replacement arising as a result of any operation from Ventrac equipment that has been altered or modified so as to, in the determination of V.P.I., adversely affect the operation, performance or durability of the equipment or that has altered, modified or affected the equipment so as to change the intended use of the product; (g) repair or replacement necessitated by the use of parts, accessories or supplies, including gasoline, oil or lubricants, incompatible with the equipment or other than as recommended in the operator's manual or other operational instructions provided by V.P.I.; (h) repairs or

WARRANTY



LIMITED WARRANTY - VENTRAC COMMERCIAL EQUIPMENT

replacements resulting from parts or accessories which have adversely affected the operation, performance or durability of the equipment; or (i) damage or defects due to or arising out of repair of the Ventrac equipment by a person or persons other than an authorized Ventrac service dealer or the installation of parts other than genuine Ventrac parts or Ventrac recommended parts.

The sole liability of V.P.I. with respect to this warranty shall be the repair and replacement as set forth herein. V.P.I. shall have no liability for any other cost, loss, or damage. In particular V.P.I. shall have no liability or responsibility for: (i) expenses relating to gasoline, oil, or lubricants; (ii) loss, cost or expense relating to transportation or delivery of turf equipment from the location of the owner or the location where used by the owner to or from any Authorized Ventrac Dealer; (iii) travel time, overtime, after hours' time or other extraordinary repair charges or charge relating to repairs or replacements outside of normal business hours at the place of business of an Authorized Ventrac Dealer; (iv) rental of like or similar replacement equipment during the period of any warranty repair or replacement work; (v) any telephone or telegram charges; (vi) loss or damage to person or property other than that covered by the terms of this warranty; (vii) any claims for lost revenue, lost profit or additional cost or expense incurred as a result of a claim of breach of warranty; or (viii) attorney's fees.

The remedies of the buyer set forth herein are exclusive and are in lieu of all other remedies. The liability of V.P.I., whether in contract, tort, under any warranty, or otherwise, shall not extend beyond its obligation as set forth herein. V.P.I. shall not be liable for cost of removal or installation nor shall V.P.I. be responsible for any direct, indirect, special or consequential damages of any nature. In no event shall V.P.I. be liable for any sum in excess of the price received for the goods for which a liability is claimed.

There are no representations or warranties which have been authorized to the buyer of the Ventrac commercial equipment other than set forth in this warranty. Any and all statements or representations made by any seller of this equipment, including those set forth in any sales literature or made orally by any sales representative, are superseded by the terms of this warranty. Any affirmation of fact or promise made by V.P.I. or any of its representatives to the buyer which relates to the goods that are the subject to this warranty shall not be regarded as part of the basis of the bargain and shall not be deemed to create any express warranty that such goods shall conform to the affirmation or promise.

No employee, distributor, or representative is authorized to change the foregoing warranties in any way or grant any other warranty on behalf of V.P.I.

Some states do not allow limitations on how long an implied warranty lasts or allow the exclusion on limitation of incidental or consequential damages, so the above limitation or exclusion may not apply to you.

This warranty gives you specific legal rights, and you may also have other rights which vary from state to state.

This warranty applies to all Ventrac commercial equipment sold by Venture Products Inc.